



MITSUBISHI

PROGRAMMABLE CONTROLLERS
MELSEC-F

Changes for the Better

Additional Product Support Version

- FX3U Series
- Inverter Communication
(F700/A700 Series)

- N:N Network
- Parallel Link
- Computer Link
- Inverter Communication
- Non-Protocol Communication
- Programming Communication
- Remote Maintenance

USER'S MANUAL - Data Communication Edition

FX SERIES PROGRAMMABLE CONTROLLERS

FX

RS-232C Interface

FX3U-232-BD
FX3U-232ADP
FX2N-232-BD
FX2NC-232ADP
FX1N-232-BD
FX0N-232ADP
FX-232ADP
FX2N-232IF

RS-485 Interface

FX3U-485-BD
FX3U-485ADP
FX2N-485-BD
FX2NC-485ADP
FX1N-485-BD
FX0N-485ADP
FX-485ADP

RS-485/232C Converter

FX-485PC-IF

RS-422 Interface

FX3U-422-BD
FX2N-422-BD
FX1N-422-BD



USB Interface



FX3U-USB-BD

Safety Precautions

(Read these precautions before use.)

Before installing, operating, maintenance or inspecting this product, thoroughly read and understand this manual and the associated manuals. Also pay careful attention to handle the module properly and safety.

This manual classifies the safety precautions into two categories:  **DANGER** and  **CAUTION**.

 DANGER	Indicates that incorrect handling may cause hazardous conditions, resulting in death or severe injury.
 CAUTION	Indicates that incorrect handling may cause hazardous conditions, resulting in medium or slight personal injury or physical damage.

Depending on circumstances, procedures indicated by  **CAUTION** may also be linked to serious results.

In any case, it is important to follow the directions for usage.

Store this manual in a safe place so that you can take it out and read it whenever necessary. Always forward it to the end user.

1. DESIGN PRECAUTIONS

 DANGER	
<ul style="list-style-type: none">• Provide a safety circuit on the outside of the PLC so that the whole system operates to ensure the safety even when external power supply trouble, PLC failure, or communication error occurs. Otherwise, malfunction or output failures may result in an accident.<ol style="list-style-type: none">1) An emergency stop circuit, a protection circuit, an interlock circuit for opposite movements, such as normal and reverse rotations, and an interlock circuit for preventing damage to the machine at the upper and lower positioning limits should be configured on the outside of the PLC.2) When the PLC CPU detects an error, such as a watchdog timer error, during self-diagnosis, all outputs are turned off. When an error that cannot be detected by the PLC CPU occurs in an input/output control block, output control may be disabled. Design external circuits and mechanisms to ensure safe operations of the machine in such a case.3) The output current of the service power supply for sensor varies depending on the model and the absence/presence of extension blocks. If overload is applied, the voltage automatically drops, inputs in the PLC are disabled, and all outputs are turned off. Design external circuits and mechanisms to ensure safe operations of the machine in such a case.4) When some sort of error occurs in a relay, triac or transistor of the output unit, output may be kept on or off. For output signals that may lead to serious accidents, design external circuits and mechanisms to ensure safe operations of the machine in such cases.	

 CAUTION	
<ul style="list-style-type: none">• Do not bundle the control line together with the main circuit or power line. Do not lay the control line near them. As a rule, lay the control line at least 100mm(3.94") or more away from the main circuit or power line. Noise may cause malfunctions.• Use the product in such a status that excessive force is not applied on the built-in programming board, power connectors, I/O connectors, communication connectors, and communication cables. Failure to do so may result in wire breakage or failure of the PLC.	

Safety Precautions

(Read these precautions before use.)

2. WIRING PRECAUTIONS

DANGER

- Cut off all phases of the power source externally before installation or wiring work in order to avoid electric shock or damage of product.
- Make sure to attach the terminal cover offered as an accessory to the product before turning on the power or starting the operation after installation or wiring work.
Failure to do so may cause electric shock.

CAUTION

- Make sure to observe the precautions below in order to prevent any damage to the machine or any accident which may be caused by abnormal data written to the PLC due to the influence of noise:
 - 1) Do not lay close or bundle with the main circuit line, high-voltage line, or load line.
Otherwise, effects of noise or surge induction are likely to take place.
Keep a safe distance of least 100 mm (3.94") from the above lines during wiring.
 - 2) Ground the shield wire or shield of a shielded cable at one point on the PLC. However, do not ground at the same point as high voltage lines.
- Perform wiring properly to the FX0N/FX2N Series extension equipment of the terminal block type in accordance with the precautions below.
Failure to do so may cause electric shock, short-circuit, wire breakage, or damages to the product.
 - The disposal size of the cable end should follow the dimensions described in this manual.
 - Tightening torque should follow the torque described in this manual.
- Observe the following items to wire the lines to the European terminal board. Ignorance of the following items may cause electric shock, short circuit, disconnection, or damage of the product.
 - The disposal size of the cable end should follow the dimensions described in this manual.
 - Tightening torque should follow the torque described in this manual.
 - Twist the end of strand wire and make sure there is no loose wires.
 - Do not solder-plate the electric wire ends.
 - Do not connect electric wires of unspecified size or beyond the specified number of electric wires.
 - Fix the electric wires so that the terminal block and connected parts of electric wires are not directly stressed.

3. STARTUP AND MAINTENANCE PRECAUTIONS

DANGER

- Do not touch any terminal while the PLC's power is on.
Doing so may cause electrical shock or malfunctions.
- Before cleaning or retightening terminals, externally cut off all phases of the power supply.
Failure to do so may expose you to shock hazard.
- Before modifying the program under operation or performing operation for forcible output, running or stopping, carefully read the manual, and sufficiently ensure the safety.
An operation error may damage the machine or cause accidents.
- Do not change programs in the PLC from two or more peripheral equipment (such as the programming tool and GOT) at the same time.
Such changes may cause destruction or malfunction of programs in the PLC.

CAUTION

- Do not disassemble or modify the PLC.
Doing so may cause failures, malfunctions or fire.
For repair, contact your local Mitsubishi Electric distributor.
- Before connecting or disconnecting any extension cable, turn off power.
Failure to do so may cause unit failure or malfunctions.
- Make sure to turn off the power before attaching or removing the peripheral equipment, expansion board, special adaptor, or function extension memory cassette.
Failure to do so may cause device failure or malfunctions.

FX Series Programmable Controllers

User's Manual [Data Communication Edition]

Manual number	JY997D16901
Manual revision	B
Date	2/2006

Foreword

This manual explains the "serial communication" provided in MELSEC-F FX Series Programmable Controllers and should be read and understood before attempting to install or use the unit. Store this manual in a safe place so that you can take it out and read it whenever necessary. Always forward it to the end user.

This manual confers no industrial property rights or any rights of any other kind, nor does it confer any patent licenses. Mitsubishi Electric Corporation cannot be held responsible for any problems involving industrial property rights which may occur as a result of using the contents noted in this manual.

Outline Precautions

- This manual provides information for the use of the FX3u Series Programmable Controllers. The manual has been written to be used by trained and competent personnel. The definition of such a person or persons is as follows;
 - 1) Any engineer who is responsible for the planning, design and construction of automatic equipment using the product associated with this manual should be of a competent nature, trained and qualified to the local and national standards required to fulfill that role. These engineers should be fully aware of all aspects of safety with regards to automated equipment.
 - 2) Any commissioning or service engineer must be of a competent nature, trained and qualified to the local and national standards required to fulfill that job. These engineers should also be trained in the use and maintenance of the completed product. This includes being completely familiar with all associated documentation for the said product. All maintenance should be carried out in accordance with established safety practices.
 - 3) All operators of the completed equipment should be trained to use that product in a safe and coordinated manner in compliance to established safety practices. The operators should also be familiar with documentation which is connected with the actual operation of the completed equipment.

Note: the term 'completed equipment' refers to a third party constructed device which contains or uses the product associated with this manual

- This product has been manufactured as a general-purpose part for general industries, and has not been designed or manufactured to be incorporated in a device or system used in purposes related to human life.
- Before using the product for special purposes such as nuclear power, electric power, aerospace, medicine or passenger movement vehicles, consult with Mitsubishi Electric.
- This product has been manufactured under strict quality control. However when installing the product where major accidents or losses could occur if the product fails, install appropriate backup or failsafe functions in the system.
- When combining this product with other products, please confirm the standard and the code, or regulations with which the user should follow. Moreover, please confirm the compatibility of this product to the system, machine, and apparatus with which a user is using.
- If in doubt at any stage during the installation of the product, always consult a professional electrical engineer who is qualified and trained to the local and national standards. If in doubt about the operation or use, please consult the nearest Mitsubishi Electric distributor.
- Since the examples indicated by this manual, technical bulletin, catalog, etc. are used as a reference, please use it after confirming the function and safety of the equipment and system. Mitsubishi Electric will accept no responsibility for actual use of the product based on these illustrative examples.
- This manual content, specification etc. may be changed without a notice for improvement.
- The information in this manual has been carefully checked and is believed to be accurate; however, if you have noticed a doubtful point, a doubtful error, etc., please contact the nearest Mitsubishi Electric distributor.

Registration

- Microsoft® and Windows® are either registered trademarks or trademarks of Microsoft Corporation in the United States and/or other countries.
- The company name and the product name to be described in this manual are the registered trademarks or trademarks of each company.

Table of Contents

SAFETY PRECAUTIONS	(1)
---------------------------------	------------

Common Item's

1. Introduction	A-1
1.1 Types of Communication Types.....	A-1
1.2 Outline and Features of Communication Types.....	A-3
1.2.1 CC-Link Network	A-3
1.2.2 N:N Network	A-4
1.2.3 Parallel Link	A-5
1.2.4 Computer Link	A-6
1.2.5 Inverter Communication	A-7
1.2.6 Non-protocol Communication	A-8
1.2.7 Programming Communication	A-9
1.2.8 Remote Maintenance	A-11
1.2.9 CC-Link/LT Network	A-12
1.2.10 AS-i system	A-13
1.2.11 Internet Mail Sending.....	A-14
1.2.12 Short Mail Sending	A-15
2. Communication Types and Communication Equipment	A-17
2.1 Relationship between Equipment and Communication Types.....	A-17
2.2 Communication Equipment Applicability Map	A-18
2.2.1 FX3U and FX3UC PLCs	A-18
2.2.2 FX2N and FX2NC PLCs	A-20
2.2.3 FX1S, FX1N, and FX1NC PLCs	A-22
2.2.4 FX0N PLCs	A-24
2.2.5 FX0, FX0S, FX2(FX), FX2C, and FX1 PLCs (reference).....	A-24
2.3 Combination of Communication Equipment (Block Diagram)	A-26
2.3.1 How to look at combination pages.....	A-26
2.3.2 For FX0N Series	A-27
2.3.3 For FX1S Series	A-29
2.3.4 For FX1N Series	A-30
2.3.5 For FX1NC Series.....	A-32
2.3.6 For FX2N Series	A-34
2.3.7 For FX2NC Series.....	A-36
2.3.8 For FX3U Series.....	A-38
2.3.9 For FX3UC Series.....	A-40
2.3.10 For FX2(FX) and FX2C Series (reference)	A-42
3. Outline of Communication Setting in FX Series	A-43
3.1 Setting Method	A-43
3.2 Communication Setting in Parameter Method (GX Developer)	A-44
3.2.1 Operating procedure.....	A-44
3.2.2 Correspondence between parameter setting and each communication network.....	A-45
3.3 Communication Setting in Parameter Method (FXGP/WIN)	A-46
3.3.1 Operating procedure.....	A-46
3.3.2 Correspondence between parameter setting and each communication type.....	A-48
3.4 Extension of Ports (FX3U, FX3UC).....	A-49
3.4.1 Limitation when ch1 and ch2 are used at same time	A-50

4. Introduction of Manuals (Type, Reading Method and Acquisition Method)	A-51
4.1 Rank and Use Method of This Manual.....	A-51
4.2 Introduction of Related Manuals	A-52
4.2.1 Manual for communication types in FX PLCs.....	A-52
4.2.2 Manuals related to FX PLCs.....	A-52
4.2.3 Communication equipment (option).....	A-53
4.2.4 Related options for communication	A-55
5. Abbreviations, Generic Names and Terms Used in This Manual	A-56

N:N Network

1. Outline	B-3
1.1 Outline of System.....	B-3
1.2 Major Procedures until Operation	B-4
1.3 Communication Type Applicability in PLC	B-5
1.3.1 Applicable versions.....	B-5
1.3.2 Products whose production was stopped	B-6
1.4 Programming Tool Applicability.....	B-6
1.4.1 For applicable versions.....	B-6
1.4.2 For non-applicable versions (setting an alternative model)	B-8
2. Specifications	B-9
2.1 Communication Specifications (Reference)	B-9
2.2 Link Specifications	B-10
2.2.1 Link patterns and number of link points in each FX Series	B-10
2.2.2 Link time	B-11
3. System Configuration and Equipment Selection	B-12
3.1 System Configuration.....	B-12
3.2 Applicable FX PLC and Communication Equipment.....	B-13
4. Wiring	B-16
4.1 Wiring Procedure	B-16
4.2 Selecting Cables and Terminal Resistors	B-17
4.2.1 Twisted pair cable.....	B-17
4.2.2 Connecting cables.....	B-18
4.2.3 Connecting terminal resistors.....	B-19
4.3 Connection Diagram	B-20
4.4 Grounding	B-20
5. Communication Setting (Initialization) in FX Programmable Controller	B-21
5.1 Check Procedure	B-21
5.2 Communication Setting in Parameter Method (GX Developer)	B-22
5.2.1 Operating procedure.....	B-22
5.3 Communication Settings in Parameter Method (FXGP/WIN)	B-23
5.3.1 Operating procedure.....	B-23
6. Test Run (Communication Test) and Judgement Method	B-24
6.1 Test Procedure.....	B-24
6.2 Creating Programs for Communication Test.....	B-26
6.2.1 Creating a program for master station.....	B-26
6.2.2 Creating a program for each slave station.....	B-27

7. Creating Programs	B-28
7.1 Checking Contents of Related Devices.....	B-28
7.2 Creating Programs for Master Station (Station No. 0)	B-30
7.3 Creating Programs for Slave Station (Station No. "n").....	B-32
7.4 Cautions on Program Creation.....	B-34
8. Practical Program Examples	B-35
8.1 Practical Example 1 (Pattern 2)	B-35
8.1.1 System configuration example	B-35
8.1.2 Contents of operations and corresponding program numbers	B-35
8.1.3 Setting contents.....	B-36
8.1.4 Setting program for master station	B-36
8.1.5 Setting program for slave station (No. 1).....	B-38
8.1.6 Setting program for slave station (No. 2).....	B-40
9. Troubleshooting	B-42
9.1 Checking FX PLC Version Applicability	B-42
9.2 Checking Communication Status Based on LED Indication	B-42
9.3 Checking Installation and Wiring.....	B-42
9.4 Checking Sequence Program	B-42
9.5 Checking Setting Contents and Errors.....	B-43
9.6 Checking Absence/Presence of Data Transfer Errors	B-44
9.6.1 Check while data transfer sequence is being executed	B-44
9.6.2 Checking data transfer sequence errors	B-44
9.6.3 Checking error codes	B-44
10. Related Data	B-46
10.1 Related Device List	B-46
10.1.1 For FX1N, FX2N, FX3U, FX1NC, FX2NC, and FX3UC PLCs	B-46
10.1.2 For FX1S and FX0N PLCs	B-50
10.2 Details of Related Devices	B-52
10.2.1 Parameter setting [M8038]	B-52
10.2.2 Channel setting [M8179].....	B-52
10.2.3 Serial communication error [M8063 and M8438].....	B-52
10.2.4 Data transfer sequence error [M8138 to M8190] [M504 to M511].....	B-53
10.2.5 Data transfer sequence ON [M8191] [M503].....	B-53
10.2.6 Serial communication error code [D8063 and D8438].....	B-53
10.2.7 Corresponding station number settings status [D8173].....	B-54
10.2.8 Slave station quantity setting status [D8174].....	B-54
10.2.9 Refresh range setting status [D8175].....	B-54
10.2.10 Station number settings [D8176]	B-54
10.2.11 Slave station quantity setting [D8177]	B-55
10.2.12 Refresh range setting [D8178].....	B-55
10.2.13 Number of retries [D8179]	B-56
10.2.14 Monitoring time setting [D8180].....	B-56
10.2.15 Present link scan time [D8201] [D201]	B-56
10.2.16 Maximum link scan time [D8202] [D202]	B-57
10.2.17 Data transfer sequence error count [D8203 to D8210] [D203 to D210]	B-57
10.2.18 Data transfer error code [D8211 to D8218] [D211 to D218].....	B-57

Parallel Link

1. Outline	C-3
1.1 Outline of System.....	C-3
1.2 Major Procedures until Operation	C-4
1.3 Communication Type Applicability in PLC	C-5
1.3.1 Applicable versions.....	C-5
1.3.2 Products whose production was stopped	C-5
1.4 Programming Tool Applicability.....	C-6
1.4.1 For applicable versions.....	C-6
1.4.2 For non-applicable versions (setting an alternative model)	C-8
2. Specifications	C-9
2.1 Communication Specifications (Reference)	C-9
2.2 Link Specifications	C-10
2.2.1 PLC communication type applicability status	C-10
2.2.2 Link time	C-10
2.3 Link Device Numbers and Number of Points	C-11
2.3.1 For FX1S and FX0N Series.....	C-11
2.3.2 For FX2(FX), FX2C, FX1N, FX2N, FX3U, FX1NC, FX2NC and FX3UC Series	C-12
3. System Configuration and Selection	C-13
3.1 System Configuration.....	C-13
3.1.1 Rule for connection.....	C-13
3.2 Configuration of Each Group.....	C-14
3.3 Applicable FX PLC and Communication Equipment.....	C-17
4. Wiring	C-21
4.1 Wiring Procedure	C-21
4.2 Selecting Cables and Terminal Resistors	C-22
4.2.1 Twisted pair cable.....	C-22
4.2.2 Connecting cables.....	C-23
4.2.3 Optical fiber cable.....	C-24
4.2.4 Connecting terminal resistors	C-24
4.3 Connection Diagram	C-25
4.3.1 For FX3U and FX3UC PLCs.....	C-25
4.3.2 For FX1S, FX1N, FX1NC, FX2N and FX2NC PLCs	C-26
4.3.3 For FX2(FX) and FX2C PLCs	C-27
4.4 Grounding	C-27
5. Communication Setting (Initialization) in FX Programmable Controller	C-28
5.1 Check Procedure	C-28
5.2 Communication Setting in Parameter Method (GX Developer)	C-29
5.2.1 Operating procedure.....	C-29
5.3 Communication Settings in Parameter Method (FXGP/WIN)	C-30
5.3.1 Operating procedure.....	C-30

6. Test Run (Communication Test) and Judgement Method	C-31
6.1 Test Procedure.....	C-31
6.2 Creating Programs for Communication Test.....	C-32
6.2.1 For FX2(FX), FX2C, FX1N, FX2N, FX3U, FX1NC, FX2NC or FX3UC Series.....	C-32
6.2.2 For FX1S or FX0N Series.....	C-33
7. Creating Programs	C-34
7.1 Regular Parallel Link Mode.....	C-34
7.1.1 Checking contents of related devices.....	C-34
7.1.2 Creating programs for master station.....	C-36
7.1.3 Creating programs for slave station.....	C-37
7.2 High Speed Parallel Link Mode.....	C-38
7.2.1 Checking contents of related devices.....	C-38
7.2.2 Creating programs for master station.....	C-40
7.2.3 Creating programs for slave station.....	C-41
7.3 Cautions on Program Creation.....	C-42
8. Practical Program Examples	C-43
8.1 Practical Example 1 (Regular Parallel Link Mode).....	C-43
8.1.1 System configuration example.....	C-43
8.1.2 Setting contents.....	C-43
8.1.3 Program for master station.....	C-44
8.1.4 Program for slave station.....	C-44
9. Troubleshooting	C-45
9.1 Checking FX PLC Version Applicability.....	C-45
9.2 Checking Communication Status Based on LED Indication.....	C-45
9.3 Checking Installation and Wiring.....	C-45
9.4 Checking Sequence Program.....	C-45
9.5 Checking Absence/Presence of Errors.....	C-46
10. Related Data	C-47
10.1 Related Device List.....	C-47
10.2 Details of Related Devices.....	C-48
10.2.1 Parallel link master station declare [M8070].....	C-48
10.2.2 Channel setting [M8178].....	C-48
10.2.3 Parallel link slave station declare [M8071].....	C-48
10.2.4 High speed parallel link mode [M8162].....	C-48
10.2.5 Parallel link ON [M8072].....	C-49
10.2.6 Parallel link setting error [M8073].....	C-49
10.2.7 Serial communication error [M8063 and M8438].....	C-49
10.2.8 Error judgement time setting [D8070].....	C-49
10.2.9 Serial communication error code [D8063 and D8438].....	C-50

Computer Link

1. Outline	D-3
1.1 Outline of System.....	D-3
1.2 Major Procedures until Operation	D-4
1.3 Communication Type Applicability in PLC	D-5
1.3.1 Applicable versions.....	D-5
1.3.2 Products whose production was stopped	D-6
1.4 Programming Tool Applicability.....	D-6
1.4.1 For applicable versions.....	D-6
1.4.2 For non-applicable versions (setting an alternative model)	D-8
2. Specifications	D-9
2.1 Communication Specifications (Reference)	D-9
2.2 Link Specifications	D-10
2.2.1 Applicable commands and number of device points	D-10
2.2.2 Applicable device ranges.....	D-11
2.2.3 Link time	D-13
3. System Configuration and Equipment Selection	D-14
3.1 System Configuration.....	D-14
3.2 Applicable FX PLC and Communication Equipment.....	D-15
3.2.1 For communication in accordance with RS-232C	D-15
3.2.2 For communication in accordance with RS-485.....	D-18
4. Wiring	D-21
4.1 Wiring Procedure	D-22
4.2 Selecting Connection Method	D-23
4.2.1 For communication in accordance with RS-232C (1-to-1 connection)	D-23
4.2.2 For communication in accordance with RS-485 (RS-422) (1-to-N connection).....	D-23
4.3 Selecting Cables and Terminal Resistors (RS-485).....	D-24
4.3.1 Twisted pair cable.....	D-24
4.3.2 Connecting cables.....	D-25
4.3.3 Connecting terminal resistors.....	D-26
4.4 Connection Diagram for RS-232C	D-27
4.4.1 Connection diagram between FX PLC and personal computer	D-27
4.4.2 Connection diagram between FX-485PC-IF and personal computer.....	D-27
4.5 Connection Diagram for RS-485 and RS-422.....	D-28
4.5.1 One-pair wiring	D-28
4.5.2 Two-pair wiring	D-28
4.6 Grounding	D-29
5. Communication Setting in FX Programmable Controller	D-30
5.1 Communication Setting Method Mechanism.....	D-30
5.2 Communication Setting in Parameter Method (GX Developer)	D-31
5.2.1 Operating procedure.....	D-31
5.3 Communication Settings in Parameter Method (FXGP/WIN)	D-33
5.3.1 Operating procedure.....	D-33

6. Control Procedures and Setting Methods	D-35
6.1 Data Flow by Link.....	D-35
6.2 Important Points in Computer Link.....	D-36
6.2.1 Operations of PLC caused by data transfer	D-36
6.3 How to Understand Control Procedure	D-37
6.4 Basic Formats of Dedicated Protocol.....	D-37
6.4.1 Control procedure format 1.....	D-38
6.4.2 Control procedure format 4.....	D-39
6.4.3 Contents of set items in each control procedure (protocol).....	D-40
6.4.4 Timeout determination time.....	D-42
6.5 Transfer Sequence Time Chart and Communication Time.....	D-43
6.5.1 When computer reads data from PLC.....	D-43
6.5.2 When computer writes data to PLC.....	D-43
6.5.3 Transfer time in transfer sequence.....	D-44
6.6 Transfer Data in Character Area.....	D-45
6.6.1 When bit device memory is read or written	D-45
6.6.2 When word device memory is read or written	D-46
7. Commands	D-47
7.1 BR Command [Which Reads Device Memory in Units of Bits]	D-48
7.2 WR Command [Which Reads Device Memory in Units of Words].....	D-49
7.3 QR Command [Which Reads Device Memory in Units of Words]	D-51
7.4 BW Command [Which Writes Device Memory in Units of Bits].....	D-53
7.5 WW Command [Which Writes Device Memory in Units of Words]	D-54
7.6 QW Command [Which Writes Device Memory in Units of Words].....	D-56
7.7 BT Command [Which Tests Device Memory in Units of Bits (by Writing at Random)]	D-58
7.8 WT Command [Which Tests Device Memory in Units of Words (by Writing at Random)].....	D-59
7.9 QT Command [Which Tests Device Memory in Units of Words (by Writing at Random)]	D-61
7.10 RR/RS Command [Which Sets PLC to RUN/STOP Mode in Remote Control].....	D-63
7.10.1 Contents of remote control to set RUN or STOP mode.....	D-63
7.10.2 Condition validating remote control to set RUN or STOP mode.....	D-63
7.10.3 Remote control specification method and specification examples	D-64
7.11 PC Command [Which Reads PLC Model Name].....	D-65
7.11.1 PLC model name (CPU) and read contents.....	D-65
7.11.2 Control procedure specification method and specification example.....	D-65
7.12 GW Command [Which Offers Global Function]	D-66
7.12.1 Contents of control	D-66
7.12.2 Global function control procedure specification method and specification example	D-66
7.13 On-demand Function	D-67
7.13.1 Special data registers and special auxiliary relays used in on-demand function.....	D-67
7.13.2 Control procedures in on-demand function	D-69
7.13.3 On-demand function specification method and specification examples	D-71
7.14 TT Command [Loop-back Test]	D-74
8. Troubleshooting	D-75
8.1 Checking FX PLC Version Applicability	D-75
8.2 Checking Communication Status Based on LED Indication	D-75
8.3 Checking Installation and Wiring.....	D-75
8.4 Checking Sequence Program	D-76
8.5 Checking Error Codes.....	D-77
8.5.1 Error codes when NAK is sent.....	D-77
8.5.2 Error codes in PLC	D-78

9. Related Data	D-79
9.1 Related Device List	D-79
9.2 Details of Related Devices	D-81
9.2.1 Serial communication error [M8063 and M8438].....	D-81
9.2.2 Cautions on use.....	D-81
9.2.3 Communication setting keep [M8120]	D-81
9.2.4 Global function ON [M8126 and M8426]	D-81
9.2.5 On-demand send processing [M8127 and M8427]	D-81
9.2.6 On-demand error flag [M8128 and M8428]	D-82
9.2.7 On-demand data word/byte changeover [M8129 and M8429]	D-82
9.2.8 Serial communication error code [D8063 and D8438].....	D-82
9.2.9 Communication format setting [D8120 and D8420].....	D-83
9.2.10 Station number settings [D8121 and D8421].....	D-84
9.2.11 On-demand data head device number specification [D8127 and D8427]	D-85
9.2.12 On-demand data quantity specification [D8128 and D8428].....	D-85
9.2.13 Timeout determination time setting [D8129 and D8429]	D-85
9.3 Communication Setting Method Using Sequence Program	D-86
9.3.1 Setting procedure	D-86
9.3.2 Caution on communication setting using sequence program.....	D-86
9.4 ASCII Code Table	D-87

Inverter Communication

1. Outline	E-3
1.1 Outline of System.....	E-3
1.2 Major Procedures until Operation	E-4
1.3 Communication Type Applicability in PLC	E-5
1.3.1 For applicable versions.....	E-5
1.4 Programming Tool Applicability.....	E-6
1.4.1 For applicable versions.....	E-6
1.4.2 For non-applicable versions (setting an alternative model).....	E-6
2. Specifications	E-7
2.1 Communication Specifications (Reference).....	E-7
2.2 Connectable Mitsubishi General-purpose Inverters	E-7
2.3 Link Specifications	E-8
2.3.1 When monitoring inverter operations (PLC ← inverter).....	E-8
2.3.2 When controlling inverter operations (PLC → inverter).....	E-8
2.3.3 Parameters (PLC ↔ inverter).....	E-8
3. System Configuration and Selection	E-9
3.1 System Configuration.....	E-9
3.2 Applicable FX PLC and Communication Equipment.....	E-10
4. Wiring	E-13
4.1 Wiring Procedure	E-14
4.2 Selecting Cables and Connection Devices	E-15
4.2.1 S500, E500, A500, F500 and V500 Series (PU connector)	E-15
4.2.2 A500, F500 and V500 Series (FR-A5NR)	E-16
4.2.3 F700 and A700 Series (built-in RS-485 terminal).....	E-17
4.3 Connection Cables.....	E-18
4.3.1 Ethernet (10BASE-T) cable.....	E-18
4.3.2 Twisted pair cable (recommended)	E-18
4.3.3 Connecting cables.....	E-19
4.4 Connection Devices (RJ45 Connector and Distributor)	E-20
4.5 Connecting Terminal Resistors	E-20
4.6 Wiring a Shielding Wire (Class-D grounding).....	E-21
4.7 Connector in Inverter.....	E-21
4.8 Connection Diagram	E-23
4.8.1 For S500, E500 and A500 Series (PU connector).....	E-23
4.8.2 For A500 Series (FR-A5NR).....	E-24
4.8.3 For F700 and A700 Series (built-in RS-485 terminal)	E-25
4.9 Grounding	E-26

5. Communication Setting in Inverter	E-27
5.1 Communication Port and Applicable Parameters	E-27
5.2 S500 Series (When Connected to RS-485 Port).....	E-28
5.2.1 Contents of parameter setting	E-28
5.2.2 Parameter setting method (reference).....	E-29
5.3 E500 Series (When Connected to PU Port).....	E-31
5.3.1 Contents of parameter setting	E-31
5.3.2 Parameter setting method (reference).....	E-32
5.4 V500, F500 and A500 Series (Connection to PU Port).....	E-34
5.4.1 Contents of parameter setting	E-34
5.4.2 Parameter setting method (reference).....	E-35
5.5 V500, F500 and A500 Series (Connection to FR-A5NR).....	E-37
5.5.1 Contents of parameter setting	E-37
5.5.2 Parameter setting method (reference).....	E-37
5.6 F700 and A700 Series (when built-in RS-485 terminal is connected).....	E-38
5.6.1 Contents of parameter setting	E-38
5.6.2 Parameter setting method (reference).....	E-39
5.7 Cautions on Setting.....	E-40
6. Communication Setting in FX Programmable Controller	E-41
6.1 Parameter Assigning Method.....	E-41
6.2 Communication Setting in Parameter Method (GX Developer)	E-42
6.2.1 Operating procedure.....	E-42
6.3 Communication Setting in Parameter Method (FXGP/WIN)	E-44
6.3.1 Operating procedure.....	E-44
7. Creating Programs (for FX2N and FX2NC PLCs)	E-46
7.1 Checking Contents of Related Devices.....	E-46
7.2 Common Items in Inverter Communication Instructions	E-47
7.2.1 Inverter communication types (EXTR K10 to K13).....	E-47
7.2.2 Function and operation	E-47
7.2.3 Instruction completion and error flag operation	E-49
7.2.4 Cautions on programming	E-51
7.3 Inverter Operation Monitoring Instruction (PLC←Inverter) [EXTR K10].....	E-52
7.3.1 Function and operation.....	E-52
7.3.2 Inverter instruction codes	E-52
7.4 Inverter Operation Control Instruction (PLC→Inverter) [EXTR K11].....	E-53
7.4.1 Function and operation.....	E-53
7.4.2 Inverter instruction codes	E-53
7.5 Inverter Parameter Reading Instruction (PLC←Inverter) [EXTR K12].....	E-54
7.5.1 Function and operation.....	E-54
7.5.2 Inverter parameter number.....	E-54
7.5.3 Program example of "second parameter specification code"	E-54
7.6 Inverter Parameter Writing Instruction (PLC→Inverter) [EXTR K13]	E-55
7.6.1 Function and operation.....	E-55
7.6.2 Inverter parameter number.....	E-55
7.6.3 Program example of "second parameter specification code"	E-55
7.7 Second Parameter Specification Codes	E-56
7.7.1 S500 Series	E-56
7.7.2 E500 Series	E-56
7.7.3 A500 Series	E-57

8. Practical Program Examples (for FX2N and FX2NC PLCs)	E-58
8.1 Practical Example 1	E-58
8.1.1 System configuration example	E-58
8.1.2 Contents of operation	E-58
8.1.3 Program example	E-59
8.2 Practical Example 2	E-62
8.2.1 System configuration example	E-62
8.2.2 Contents of operation	E-62
8.2.3 Program example	E-63
9. Creating Programs (for FX3U and FX3UC PLCs)	E-67
9.1 Differences between FX2N/FX2NC PLCs and FX3U/FX3UC PLCs	E-67
9.2 Contents of Related Devices	E-68
9.3 Common Items in Inverter Communication Instructions	E-69
9.3.1 Inverter communication types (IVCK to IVBWR)	E-69
9.3.2 Function and operation	E-69
9.3.3 Instruction completion and error flag operation	E-71
9.3.4 Cautions on programming	E-73
9.4 Inverter Operation Monitoring Instruction (PLC←Inverter) [FNC270 / IVCK]	E-74
9.4.1 Function and operation	E-74
9.4.2 Inverter instruction codes	E-74
9.5 Inverter Operation Control Instruction (PLC→Inverter) [FNC271 / IVDR]	E-75
9.5.1 Function and operation	E-75
9.5.2 Inverter instruction codes	E-75
9.6 Inverter Parameter Reading (PLC←Inverter) [FNC272 / IVRD]	E-76
9.6.1 Function and operation	E-76
9.6.2 Inverter instruction codes	E-76
9.6.3 Program example of "second parameter specification code"	E-76
9.7 Inverter Parameter Writing (PLC→Inverter) [FNC273 / IVWR]	E-77
9.7.1 Function and operation	E-77
9.7.2 Inverter instruction codes	E-77
9.7.3 Program example of "second parameter specification code"	E-77
9.8 Inverter Parameter Batch Writing (PLC→Inverter) [FNC274 / IVBWR]	E-78
9.8.1 Function and operation	E-78
9.9 Second Parameter Specification Codes	E-79
9.9.1 S500 Series	E-79
9.9.2 E500 Series	E-79
9.9.3 A500 Series	E-80
9.9.4 F500 Series	E-81
9.9.5 V500 Series	E-81
9.9.6 F700 Series	E-81
9.9.7 A700 Series	E-82
10. Practical Program Examples (for FX3U and FX3UC PLCs)	E-83
10.1 Practical Example 1	E-83
10.1.1 System configuration example	E-83
10.1.2 Contents of operation	E-83
10.1.3 Program example	E-84
10.2 Practical Example 2	E-87
10.2.1 System configuration example	E-87
10.2.2 Contents of operation	E-87
10.2.3 Program example	E-88

11. Troubleshooting	E-92
11.1 Checking FX PLC Version Applicability (FX2N and FX2NC Series)	E-92
11.2 Checking Communication Status Based on LED Indication	E-92
11.3 Checking Installation	E-92
11.4 Checking Sequence Program	E-93
11.4.1 Checking inverter operation status	E-93
11.5 Checking Absence/Presence of Errors	E-93
11.6 Error Codes	E-94
12. Related Data	E-96
12.1 Related Device List for FX2N and FX2NC PLCs	E-96
12.2 Details of Related Devices for FX2N and FX2NC PLCs	E-97
12.2.1 Instruction execution complete [M8029]	E-97
12.2.2 Extension ROM cassette check [M8104]	E-97
12.2.3 Communication port busy [M8155]	E-97
12.2.4 Communication error or parameter error [M8156]	E-97
12.2.5 Communication error latch [M8157]	E-98
12.2.6 Extension ROM cassette type code [D8104]	E-98
12.2.7 Extension ROM cassette version [D8105]	E-98
12.2.8 Inverter response waiting time [D8154]	E-98
12.2.9 Step number of instruction using communication port [D8155]	E-98
12.2.10 Error code [D8156]	E-99
12.2.11 Error occurrence step number latch [D8157]	E-100
12.3 Related Device List for FX3U and FX3UC PLCs	E-101
12.4 Details of Related Devices for FX3U and FX3UC PLCs	E-102
12.4.1 Instruction execution complete [M8029]	E-102
12.4.2 Serial communication error [M8063 and M8438]	E-102
12.4.3 Inverter communication ON [M8151 and M8156]	E-102
12.4.4 Inverter communication error [M8152, M8153, M8157 and M8158]	E-103
12.4.5 IVBWR instruction error [M8154 and M8159]	E-103
12.4.6 Serial communication error code [D8063 and D8438]	E-103
12.4.7 Inverter response waiting time [D8150 and D8155]	E-103
12.4.8 Step number of instruction using communication port [D8151 and D8156]	E-104
12.4.9 Inverter communication error code [D8152 and D8157]	E-104
12.4.10 Inverter communication error occurrence step [D8153 and D8158]	E-105
12.4.11 IVBWR instruction error parameter number [D8154 and D8159]	E-106
12.5 FREQROL Inverter Parameter List	E-107
12.5.1 Parameters in V500, F500, A500, E500, and S500 Series	E-107
12.5.2 Parameters in F700, A700 Series	E-129
12.5.3 Communication parameters	E-141

Non-Protocol Communication (RS/RS2 Instruction)

1. Outline	F-3
1.1 Outline of System.....	F-3
1.2 Major Procedures until Operation	F-5
1.3 Communication Type Applicability in PLC	F-6
1.3.1 Applicable versions.....	F-6
1.3.2 Products whose production was stopped	F-7
1.4 Programming Tool Applicability.....	F-7
1.4.1 For applicable versions.....	F-7
1.4.2 For non-applicable versions (setting an alternative model)	F-9
2. Specifications	F-10
2.1 Communication Specifications (Reference)	F-10
2.2 Data Communication Specifications	F-11
2.2.1 Communication type applicability in PLC	F-11
2.3 Number of Transfer Data	F-12
3. System Configuration and Selection	F-13
3.1 System Configuration.....	F-13
3.2 Applicable FX PLC and Communication Equipment.....	F-14
3.2.1 For communication in accordance with RS-232C	F-14
3.2.2 For communication in accordance with RS-485.....	F-17
4. Wiring	F-20
4.1 Wiring Procedure	F-20
4.2 Selecting Cables and Terminal Resistors	F-21
4.2.1 Twisted pair cable.....	F-21
4.2.2 Connecting cables.....	F-22
4.2.3 Connecting terminal resistors.....	F-23
4.3 Connection Diagram	F-24
4.3.1 Connector pin arrangement in communication equipment operating in accordance with RS-232C.....	F-24
4.3.2 Wiring for communication in accordance with RS-232C	F-24
4.3.3 Wiring for communication in accordance with RS-485.....	F-25
4.3.4 One-pair wiring	F-25
4.3.5 Two-pair wiring	F-25
4.4 Grounding	F-26
5. Communication Setting in FX Programmable Controller	F-27
5.1 Communication Setting Method Mechanism.....	F-27
5.2 Communication Setting in Parameter Method (GX Developer)	F-28
5.2.1 Operating procedure.....	F-28
5.3 Communication Setting in Parameter Method (FXGP/WIN)	F-30
5.3.1 Operating procedure.....	F-30

6. Creating Programs (RS Instruction)	F-32
6.1 Checking Contents of Related Devices.....	F-32
6.2 How to Use RS Instruction	F-33
6.2.1 Applicable frames	F-33
6.2.2 Function and operation	F-34
6.2.3 Send/receive data and amount of data.....	F-35
6.2.4 Operation when data is sent.....	F-37
6.2.5 Operation when data is received	F-37
6.3 Operation of Control Line	F-39
6.3.1 FX2(FX), FX2C, FX1S, FX0N, FX1N, FX1NC, and FX2N (before Ver. 2.00) PLCs	F-39
6.3.2 FX2N (Ver. 2.00 or later), FX3U, FX2NC, and FX3UC PLCs	F-41
6.4 Important Points in Creating Programs	F-43
6.5 Communication Error	F-43
7. Practical Program Example (RS Instruction)	F-44
7.1 Example of Printing Using RS Instruction (in Connection in Accordance with RS-232C).....	F-44
8. Creating Programs (RS2 Instruction)	F-46
8.1 Checking Contents of Related Devices.....	F-46
8.2 How to Use RS2 Instruction	F-48
8.2.1 Applicable frames	F-49
8.2.2 Function and operation.....	F-50
8.2.3 Send/receive data and amount of data.....	F-51
8.2.4 Operation when data is sent.....	F-53
8.2.5 Operation when data is received	F-53
8.2.6 Sum check code	F-55
8.3 Operation of Control Line	F-56
8.4 Important Points in Creating Programs	F-59
8.5 Communication Error	F-59
9. Practical Program Example (RS2 Instruction)	F-60
9.1 Example of Printing Using RS2 Instruction (in Connection in Accordance with RS-232C).....	F-60
10. When Combined with Another Communication	F-62
10.1 Other Communication Type Used Together	F-62
10.2 When Combined with Programming Communication	F-63
10.2.1 For FX2N and FX2NC PLCs.....	F-63
10.2.2 For FX3U and FX3UC PLCs.....	F-64
10.3 When Combined with Computer Link Communication (Only in FX3U and FX3UC)	F-65
10.4 When Combined with Programming Communication	F-66
10.5 Using RS2 Instruction and Computer Link Communication Together.....	F-67
10.6 Communication Setting Method Using Sequence Program.....	F-68
10.6.1 Communication setting for RS instruction	F-68
10.6.2 Communication setting for RS2 instruction	F-69

11. Troubleshooting	F-70
11.1 Checking FX PLC Version Applicability	F-70
11.2 Checking Communication Status Based on LED Indication	F-70
11.3 Checking Installation	F-70
11.4 Checking Sequence Program	F-71
11.4.1 Checking communication port settings (in FX3U and FX3UC PLCs)	F-71
11.5 Checking Absence/Presence of Errors	F-72
12. Related Data	F-73
12.1 Related Device List (RS Instruction)	F-73
12.2 Details of related devices (RS instruction)	F-74
12.2.1 Serial communication error [M8063].....	F-74
12.2.2 Communication setting keep [M8120]	F-74
12.2.3 Sending wait flag [M8121]	F-74
12.2.4 Sending request [M8122]	F-74
12.2.5 Receiving complete flag [M8123]	F-75
12.2.6 Carrier detection flag [M8124]	F-75
12.2.7 Timeout determination flag [M8129].....	F-75
12.2.8 Serial communication error code [D8063]	F-76
12.2.9 Communication format setting [D8120]	F-77
12.2.10 Amount of remaining send data [D8122]	F-77
12.2.11 Amount of data already received [D8123]	F-78
12.2.12 Header [D8124]	F-78
12.2.13 Terminator [D8125].....	F-78
12.2.14 Timeout determination time [D8129]	F-78
12.2.15 Communication parameter display [D8405]	F-78
12.2.16 Operation mode display [D8419].....	F-79
12.3 Related Devices (RS2 Instruction)	F-79
12.4 Details of Related Devices (RS2 Instruction)	F-80
12.4.1 Serial communication error [M8063 and M8438].....	F-80
12.4.2 Sending wait flag [M8401 and M8421]	F-80
12.4.3 Sending request [M8402 and M8422]	F-81
12.4.4 Receiving complete flag [M8403 and M8423]	F-81
12.4.5 Carrier detection flag [M8404 and M8424]	F-81
12.4.6 Data set ready (DSR) flag [M8405 and M8425]	F-81
12.4.7 Timeout determination flag [M8409 and M8429]	F-82
12.4.8 Serial communication error code [D8063 and D8438].....	F-82
12.4.9 Communication format setting [D8400 and D8420].....	F-83
12.4.10 Amount of remaining send data [D8402 and D8422]	F-84
12.4.11 Amount of data already received [D8403 and D8423].....	F-84
12.4.12 Communication parameter display [D8405 and D8425].....	F-84
12.4.13 Timeout determination time [D8409 and D8429].....	F-84
12.4.14 Header [D8410, D8411, D8430 and D8431]	F-85
12.4.15 Terminator [D8412, D8413, D8432 and D8433].....	F-85
12.4.16 Receiving sum (receive data) [D8414 and D8434].....	F-85
12.4.17 Receiving sum (calculation result) [D8415 and D8435].....	F-86
12.4.18 Sending sum [D8416 and D8436]	F-86
12.4.19 Operation mode display [D8419 and D8439]	F-86
12.5 ASCII Code Table	F-87

Non-Protocol Communication (FX_{2N}-232IF)

1. Outline	G-3
1.1 Features	G-3
1.2 Major Procedures until Operation	G-4
1.3 Communication Type Applicability in PLC	G-5
1.3.1 Applicable versions.....	G-5
1.3.2 Products whose production was stopped	G-5
1.4 Programming Tool Applicability.....	G-6
1.4.1 For applicable versions.....	G-6
1.4.2 For non-applicable versions (setting an alternative model)	G-7
2. Specification	G-8
2.1 Communication Specifications	G-8
3. System Configuration and Selection	G-9
3.1 System Configuration.....	G-9
3.2 Applicable FX PLC and Communication Equipment.....	G-9
3.3 Connection to PLC	G-10
4. Wiring	G-12
4.1 Pin Arrangement	G-12
4.2 Connection to Counterpart Equipment Having Terminal Specifications (without Control Line) ...	G-12
4.3 Connection to Counterpart Equipment Having Terminal Specifications (with Control Line)	G-13
4.3.1 Standard RS-232C mode	G-13
4.3.2 Interlink connection mode.....	G-13
4.4 Connection to Counterpart Equipment Having Modem Specifications	G-13
5. Creating Programs	G-14
5.1 Outline of Communication between FX PLC and 232IF	G-14
5.1.1 For FROM and TO instructions	G-14
5.1.2 For direct specification of buffer memory (U□\G□)	G-14
5.2 FROM and TO Instructions	G-15
5.2.1 FROM instruction.....	G-15
5.2.2 TO instruction	G-16
5.3 Direct Specification of Buffer Memory (U□\G□).....	G-17

- 5.4 Buffer Memory (BFM)..... G-18
 - 5.4.1 Buffer memory list..... G-18
 - 5.4.2 Communication format <BFM #0>..... G-20
 - 5.4.3 Command <BFM #1> G-24
 - 5.4.4 Maximum number of receivable bytes <BFM #2> G-25
 - 5.4.5 Receiving timeout time <BFM #3> G-25
 - 5.4.6 Sending header <BFM #5 (highest-order 2 bytes) and BFM #4 (lowest-order 2 bytes)> G-25
 - 5.4.7 Sending terminator <BFM #7 (highest-order 2 bytes) and BFM #6 (lowest-order 2 bytes) G-25
 - 5.4.8 Receiving header <BFM #9 (highest-order 2 bytes) and BFM #8 (lowest-order 2 bytes)> G-25
 - 5.4.9 Receiving terminator <BFM #11 (highest-order 2 bytes) and BFM #10 (lowest-order 2 bytes)> G-26
 - 5.4.10 Receiving suspension waiting time <BFM #12>..... G-26
 - 5.4.11 Amount of remaining send data <BFM #13>..... G-26
 - 5.4.12 Amount of received data buffers <BFM #14>..... G-26
 - 5.4.13 Sending sum result <BFM #15>..... G-27
 - 5.4.14 Receiving sum result <BFM #16> G-27
 - 5.4.15 Time from CS ON to sending start <BFM #20>..... G-27
 - 5.4.16 Time from actual sending completion to RS OFF <BFM #21>..... G-27
 - 5.4.17 Status <BFM #28>..... G-28
 - 5.4.18 Error code <BFM #29>..... G-29
 - 5.4.19 Model code <BFM #30> G-29
 - 5.4.20 Number of bytes to be sent <BFM #1000>..... G-29
 - 5.4.21 Send data buffer <BFM #1001 to 1256> G-29
 - 5.4.22 Number of received bytes <BFM #2000>..... G-29
 - 5.4.23 Receive data buffer <BFM #2001 to 2256>..... G-29
 - 5.4.24 Preliminary receive data buffer for interlink connection mode <BFM #2257 to 2271> G-29
- 5.5 Operation of Control Line G-30
 - 5.5.1 When control line is not provided [BFM #0, (b9, b8) = (0, 0)]..... G-30
 - 5.5.2 When control line is in standard RS-232C mode [BFM #0, (b9, b8) = (0, 1)] G-31
 - 5.5.3 When control line is in RS-232C interlink mode [BFM #0, (b9, b8) = (1, 1)]..... G-32

6. Practical Program Examples **G-33**

- 6.1 Example of Sending/Receiving Data Having 16-bit Buffer Length..... G-33
- 6.2 Sending/Receiving Data Having 8-bit Buffer Length..... G-37

7. Troubleshooting **G-41**

- 7.1 Check Items G-41
- 7.2 Error Codes..... G-41

Programming Communication

1. Outline	H-3
1.1 Outline of System.....	H-3
1.2 Major Procedures until Operation	H-4
1.3 Communication Type Applicability in PLC	H-5
1.3.1 Applicable versions.....	H-5
1.3.2 Products whose production was stopped	H-5
1.4 Programming Tool Applicability.....	H-6
1.4.1 For applicable versions.....	H-6
1.4.2 For non-applicable versions (setting an alternative model)	H-8
2. System Configuration and Selection	H-9
2.1 System Configuration.....	H-9
2.1.1 For communication equipment operating in accordance with RS-422	H-9
2.1.2 For communication equipment operating in accordance with RS-232C.....	H-10
2.1.3 For communication equipment operating in accordance with USB	H-10
2.2 Applicable FX PLC and Communication Equipment.....	H-11
2.3 Caution on Selection	H-15
2.3.1 When using 422BD.....	H-15
2.3.2 When using 232BD or 232ADP	H-16
2.3.3 Other cautions	H-16
3. Selecting Connection Cables	H-17
3.1 Connection Procedure	H-17
3.2 Connector Shape in Each Product.....	H-18
3.3 Combinations of Connection Cables.....	H-19
3.3.1 Handy programming panel	H-19
3.3.2 Personal computer	H-20
4. Connection Cables and Interfaces	H-23
4.1 Simplified Tables.....	H-23
4.1.1 Cable connector shape correspondence table	H-23
4.1.2 Cable combination simplified table	H-24
4.2 Cable Connection Diagrams	H-25
4.2.1 Personal computer connection cable - No. A	H-25
4.2.2 Connector conversion cable (commercial product) - No. B	H-27
4.2.3 FX-10P/FX-20P connection cable - No. C.....	H-27
5. Communication Setting (Initialization) in FX Programmable Controller	H-28
5.1 Check Procedure	H-28
5.2 Communication Setting in Parameter Method (GX Developer)	H-29
5.2.1 Operating procedure.....	H-29
5.3 Communication Setting in Parameter Method (FXGP/WIN)	H-30
5.3.1 Operating procedure.....	H-30

6. Connection Setting for Personal Computer	H-31
6.1 Connection Setting (GX Developer).....	H-31
6.1.1 Setting RS-232C or USB, communication port, and transmission speed.....	H-32
6.1.2 Setting CPU unit (in FX3U and FX3UC).....	H-33
6.1.3 Setting communication time check and number of retries.....	H-33
6.2 Connection Setting (FXGP/WIN).....	H-34
6.2.1 Setting communication port and transmission speed.....	H-34
6.3 Communication Test (Only in GX Developer).....	H-35

7. Troubleshooting	H-36
7.1 Checking PLC Version Applicability.....	H-36
7.2 Checking Programming Tool Applicability.....	H-36
7.3 Checking Communication Status Based on LED Indication.....	H-36
7.4 Checking Installation.....	H-36
7.5 Checking Parameters in PLC.....	H-36
7.6 Checking Sequence Program.....	H-37
7.7 Checking Setting in Programming Tool.....	H-37
7.8 Checking Absence/Presence of Errors.....	H-38

Remote Maintenance

1. Outline	I-3
1.1 Outline of System.....	I-3
1.1.1 Maintenance for programs in PLC.....	I-3
1.1.2 File transfer between personal computers (supported only by FXGP/WIN).....	I-4
1.2 Major Procedures until Operation	I-5
1.3 Communication Type Applicability in PLC	I-6
1.3.1 Applicable versions.....	I-6
1.3.2 Products whose production was stopped	I-6
1.4 Programming Tool Applicability.....	I-7
1.4.1 Programming tool for setting modem connected to PLC.....	I-7
1.4.2 Programming software for remote maintenance	I-9
1.4.3 Cautions on using FXGP/WIN.....	I-10
2. Specifications	I-11
2.1 Communication Specifications (Reference).....	I-11
3. System Configuration and Selection	I-12
3.1 System Configuration.....	I-12
3.2 Setting Applicable FX PLC and Communication Equipment.....	I-13
3.3 Selecting Modem	I-16
3.3.1 List of modems whose operations are confirmed.....	I-17
4. Wiring	I-18
4.1 Wiring Procedure	I-18
4.2 Connection Diagram	I-18
5. How to Set Modem on PLC Side	I-19
5.1 Setting Using GX Developer	I-19
5.1.1 Setting communication by way of RS-232C port.....	I-19
5.1.2 Modem initialization setting in parameter method	I-21
5.1.3 Setting AT command for unregistered modem.....	I-23
5.2 Setting Using FXGP/WIN.....	I-26
5.2.1 Setting communication by way of RS-232C port.....	I-26
5.2.2 Modem initialization setting in parameter method	I-27
5.2.3 Setting AT command for unregistered modem.....	I-28
5.3 Cautions on Use.....	I-30
6. How to Set Modem on Side of Personal Computer for Remote Access	I-31
6.1 Setting Using GX Developer	I-31
6.1.1 Registering AT command for connected modem	I-31
6.1.2 Creating telephone directory (if necessary).....	I-33
6.2 Setting Using FXGP/WIN.....	I-35
6.2.1 Registering AT command for connected modem	I-35
6.2.2 Registering line connection destination.....	I-38

7. Connecting Line	I-39
7.1 Preparing for Connection of PLC	I-39
7.2 Line Connection Procedure.....	I-40
7.2.1 For GX Developer.....	I-40
7.2.2 For FXGP/WIN	I-44
8. Troubleshooting	I-47
8.1 Checking FX PLC Applicability.....	I-47
8.2 Checking Programming Tool Applicability.....	I-47
8.3 Checking Communication Status Based on LED Indication	I-47
8.4 Checking Installation	I-47
8.5 Checking Modem Specifications	I-48
8.6 Checking Setting in PLC	I-48
8.6.1 Checking parameters in PLC.....	I-48
8.6.2 Checking AT command setting.....	I-49
8.6.3 Checking sequence program.....	I-50
8.7 Checking Setting in Programming Tool.....	I-50
8.8 Checking Absence/Presence of Errors	I-51
9. Related Information	I-52
9.1 ASCII Code Table	I-52
Warranty.....	i
Revised History	ii

1. Introduction

This manual explains the communication types supported by FX PLCs. This chapter explains the outline of serial communication (in accordance with RS-232C, RS-485/RS-422), various link communication types, etc. and provides the applicable FX PLCs.

1.1 Types of Communication Types

The table below shows the communication types supported by the FX Series.

Link		Reference subsection	
CC-Link	Function	<ul style="list-style-type: none"> Connects FX PLCs as remote device stations to the CC-Link system whose master station is a MELSEC A/QnA/Q PLC. Constructs the CC-Link system whose master station is an FX PLC. 	1.2.1
	Application	Line control in the distributed or centralized method and information transfer from/to the host network.	
N:N Network	Function	Easily enables data link between FX PLCs.	1.2.2
	Application	Line control in the distributed or centralized method.	
Parallel link	Function	Easily enables data link between FX PLCs.	1.2.3
	Application	Line control in the distributed or centralized method.	
Computer link	Function	Connects a personal computer or another computer as the master station, and connects FX PLCs as slave stations. Protocols in a computer support computer link protocol formats 1 and 4.	1.2.4
	Application	Data acquisition and centralized control.	
Inverter communication	Function	Controls Mitsubishi inverter FREQROL through communication.	1.2.5
	Application	Operation monitoring, writing of control values, reference and change of parameters, etc.	
General-purpose serial communication		Reference subsection	
Non-protocol communication	Function	Receives and sends data from/to various equipment having RS-232C or RS-485 interface in non-protocol procedures.	1.2.6
	Application	Data reception and sending from/to personal computer, bar code reader, printer and various measuring instruments.	
Sequence program		Reference subsection	
Programming communication	Function	Adds RS-232C and RS-422 ports in addition to the RS-422 port provided as standard in PLCs.	1.2.7
	Application	Connection of two display units, programming tools, etc. at the same time.	
Remote maintenance	Function	Connects a PLC located in a distant place through the modem and telephone line to enable program transfer and remote access for monitoring.	1.2.8
	Application	Maintenance of sequence programs in FX PLCs.	

A	Common Items
B	N:N Network
C	Parallel Link
D	Computer Link
E	Inverter Communication
F	Non-Protocol Communication (RS/RS2 Instruction)
G	Non-Protocol Communication (FX2N-232IF)
H	Programming Communication
I	Remote Maintenance

I/O link			Reference subsection
CC-Link/LT (built in FX3UC)	Function	Constructs the CC-Link/LT system whose master station is an FX PLC.	1.2.9
	Application	Wire-saving network inside control panel and unit.	
AS-i system	Function	Constructs the AS-i (Actuator Sensor Interface) system whose master block is an FX PLC.	1.2.10
	Application	Wire-saving network inside control panel and unit	
MELSEC I/O link	Function	Installs remote I/O units near I/O equipment in distant places to save wiring.	—
	Application	ON/OFF control of I/O equipment in distant place.	
Electronic mail sending			Reference subsection
Internet mail	Function	Sends internet mails to personal computers and cellular phones using the RS-232C communication type in PLC.	1.2.11
	Application	Monitoring of unmanned facilities, facilities located in distant places and facilities inside factories.	
Short mail	Function	Sends short mails to cellular phones in the NTT DoCoMo network.	1.2.12
	Application	Notice of material shortage, error contents, operating time, etc.	

1.2 Outline and Features of Communication Types

This section outlines the communication types supported by FX PLCs.

1.2.1 CC-Link Network

→ Refer to the manual of each special function product.

1. Outline

1) When the master station is an A/QnA/Q PLC

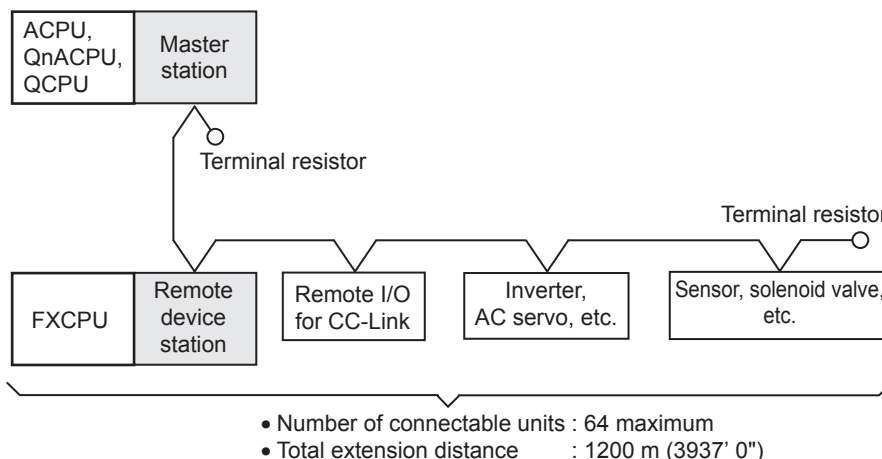

2) When the master station is an FX PLC

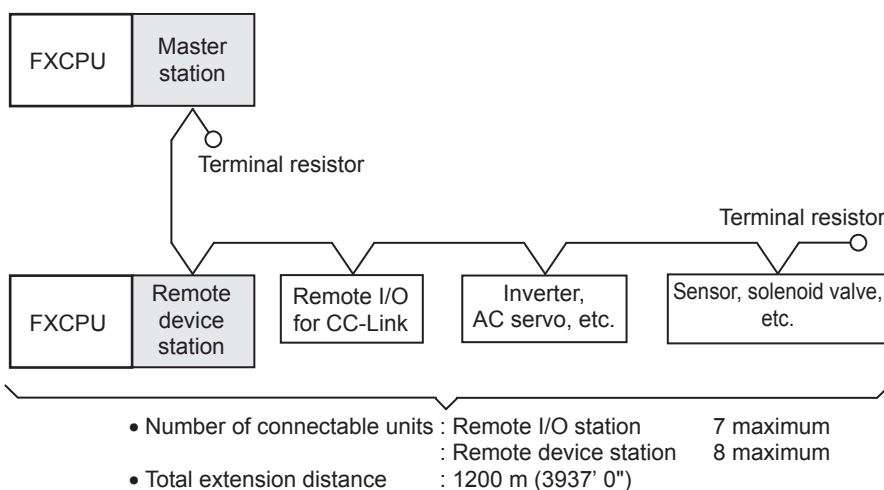

2. Applicable PLCs

✓: Applicable (If applicable versions are limited, they are described inside ().)
—: Not applicable

PLC	FX2(FX),FX2c	FX0N	FX1S	FX1N	FX1NC	FX2N,FX2NC	FX3U,FX3UC
Master station	—	—	—	✓ (Ver.1.10 or later)	✓	✓ (Ver.2.20 or later)	✓
Remote device station	—	✓	—	✓	✓	✓	✓

3. Communication targets

Equipment operating in accordance with the CC-Link standard

4. Function

This network allows connection of an inverter, AC servo, sensor, solenoid valve, etc. supporting the CC-Link network to achieve data link.

FX PLCs are classified as master stations or remote device stations.

5. Applications

Distributed or centralized control of the line, reception and sending of information from/to the host network, etc.

6. Detailed information on CC-Link

For details on CC-Link and connectable equipment, refer to the CC-Link Partner Association's homepage or catalogues (issued by the CC-Link Partner Association).

→ **CC-Link Partner Association's homepage: <http://www.cc-link.org/>**

1.2.2 N:N Network

→ Refer to the edition "N:N Network."

1. Outline

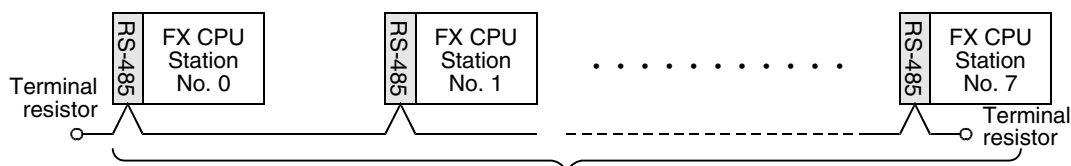

- Number of connectable FX PLCs : 8 maximum (station Nos. 0 to 7)
- Total extension distance : 500 m (1640' 5") [50 m (164' 0") when 485BD is connected]

For FX3U PLC (pattern 2)

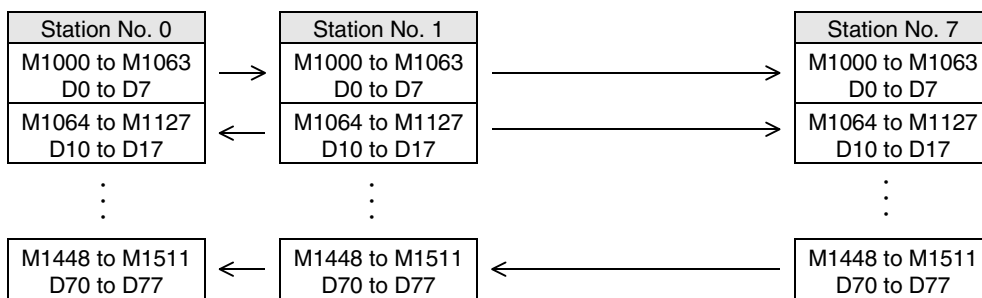

2. Applicable PLCs

✓: Applicable (If applicable versions are limited, they are described inside ().)
—: Not applicable

PLC	FX2(FX),FX2C	FX0N	FX1S,FX1N,FX1NC	FX2N	FX2NC	FX3U,FX3UC
Communication applicability	—	✓ (Ver.2.00 or later)	✓	✓ (Ver.2.00 or later)	✓	✓

3. Communication targets

Between PLCs in the FX1S, FX0N, FX1N, FX2N, FX3U, FX1NC, FX2NC, and FX3UC Series

4. Function

This network allows connection of up to eight FX PLCs to automatically transfer data among the connected PLCs.

In the network, data can be transferred among PLCs for devices determined in the refresh range, and such devices can be monitored in every PLC.

5. Applications

By this network, data link can be achieved in a small-scale system, and the machine information can be transferred between machines.

1.2.3 Parallel Link

→ Refer to the section "Parallel Link."

1. Outline

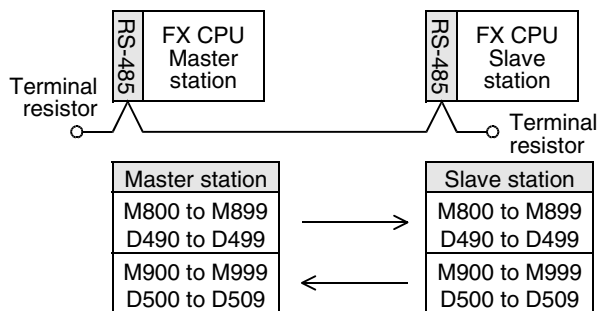

100 bit devices (M) and 10 word devices (D)

- Number of connectable FX PLCs: 2
 - Total extension distance: 500 m (1640' 5") [50 m (164' 0") when 485BD is connected]*1
- *1 The distance is different for the FX2-40AW/AP.

2. Applicable PLCs

✓: Applicable (If applicable versions are limited, they are described inside ().)
—: Not applicable

PLC	FX2(FX),FX2C	FX0N	FX1S,FX1N,FX1NC	FX2N	FX2NC	FX3U,FX3UC
Communication applicability	✓	✓ (Ver.1.20 or later)	✓	✓ (Ver.1.04 or later)	✓	✓

3. Communication targets

Between PLCs in the FX2(FX), FX2C, FX1S, FX0N, FX1N, FX2N, FX3U, FX1NC, FX2NC, and FX3UC Series

4. Function

This network automatically transfers data for 100 bit devices (M) and 10 data registers (D) between two PLCs of the same series.

Between PLCs in the FX0N or FX1S Series, data can be transferred for 50 bit devices (M) and 10 data registers (D).

5. Applications

The information can be transferred between two FX PLCs.

(It is recommended to use the N:N Network when connecting two PLCs in the same series among the FX1S, FX1N, FX2N, FX3U, FX1NC, FX2NC, and FX3UC Series. Because N:N Network functionality supports linking of up to eight FX PLC units, it offers excellent future extensibility options.)

A	Common Items
B	N:N Network
C	Parallel Link
D	Computer Link
E	Inverter Communication
F	Non-Protocol Communication (RS/RS2 Instruction)
G	Non-Protocol Communication (FX2N-232IF)
H	Programming Communication
I	Remote Maintenance

1.2.4 Computer Link

→ Refer to the section "Computer Link."

1. Outline

1) 1-to-N connection (RS-485)

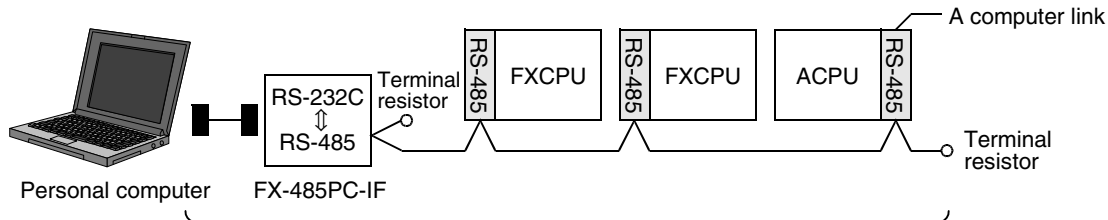

- Number of connectable FX/A PLCs : 16 maximum
- Total extension distance : 500 m (1640' 5") [50 m (164' 0") when 485BD is connected]

2) 1-to-1 connection (RS-232C)

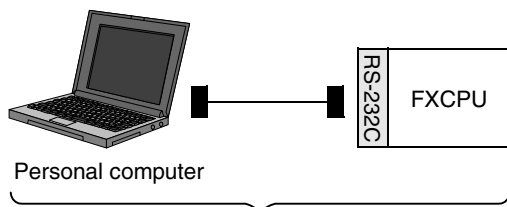

- Number of connectable FX PLCs : 1
- Total extension distance : 15 m (49' 2")

2. Applicable PLCs

✓: Applicable (If applicable versions are limited, they are described inside ().)
—: Not applicable

PLC	FX2(FX),FX2C	FX0N	FX1S,FX1N,FX1NC	FX2N	FX2NC	FX3U,FX3UC
Communication applicability	✓ (Ver.3.30 or later)	✓ (Ver.1.20 or later)	✓	✓ (Ver.1.06 or later)	✓	✓

3. Communication targets

Between FX2(FX), FX2C, FX1S, FX0N, FX1N, FX2N, FX3U, FX1NC, FX2NC, FX3UC Series, A Series PLCs and personal computers

4. Function

This link allows connection of up to sixteen FX or A (including A1FX CPU) PLCs to a personal computer to achieve data transfer when the personal computer directly specifies devices in the connected PLCs.

5. Applications

By this link, production, inventory, etc. can be controlled.

1.2.5 Inverter Communication

→ Refer to the section "Inverter Communication."

1. Outline

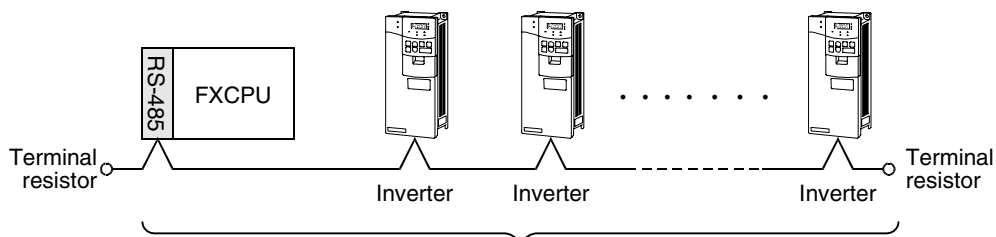

- Number of connectable inverters : 8 maximum
- Total extension distance : 500 m (1640' 5") [50 m (164' 0") when 485BD is connected]

2. Applicable PLCs

✓: Applicable (If applicable versions are limited, they are described inside ().)
—: Not applicable

PLC	FX2(FX),FX2C	FX0N	FX1S,FX1N,FX1NC	FX2N	FX2NC	FX3U,FX3UC
Communication applicability	—	—	—	✓ (Ver.3.00 or later)	✓ (Ver.3.00 or later)	✓

3. Communication targets

- 1) For FX2N or FX2NC PLC
FREQROL Series (S500, E500 and A500) inverters
 - 2) For FX3U or FX3UC PLC
FREQROL Series (S500, E500, A500, F500, V500, F700*1 and A700*1) inverters
- *1. F700 and A700 Series inverters are supported in FX3U and FX3UC PLCs Ver. 2.20 and later.

4. Function

This communication allows connection of inverters (computer link) in accordance with RS-485 to control operations and change parameters.

5. Applications

Operations with up to eight inverters can be controlled from a PLC.

A	Common Items
B	N:N Network
C	Parallel Link
D	Computer Link
E	Inverter Communication
F	Non-Protocol Communication (RS/RS2 Instruction)
G	Non-Protocol Communication (FX2N-232IF)
H	Programming Communication
I	Remote Maintenance

1.2.6 Non-protocol Communication

→ Refer to the section "Non-protocol Communication (RS/RS2 instruction)."
→ Refer to the section "Non-protocol Communication (FX2N-232IF)."

1. Outline

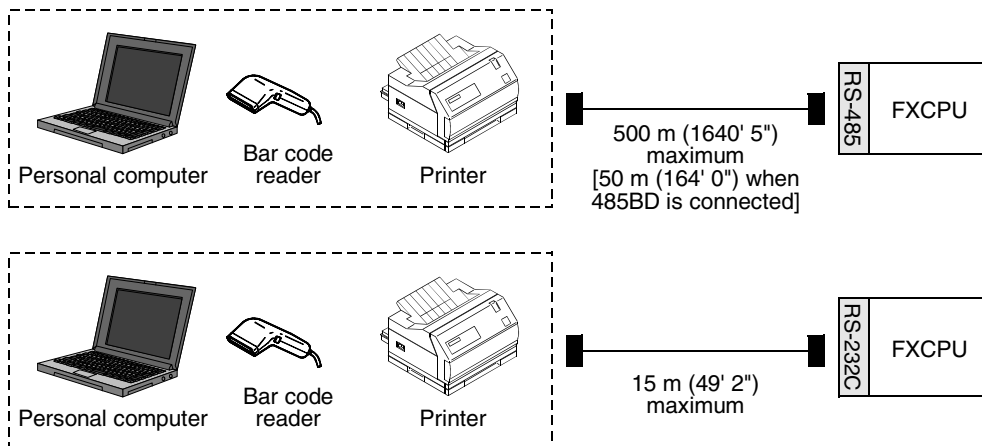

2. Applicable PLCs

1) Non-protocol communication (RS instruction)

✓: Applicable (If applicable versions are limited, they are described inside ().)
—: Not applicable

PLC	FX2(FX),FX2C	FX0N	FX1S,FX1N,FX1NC	FX2N	FX2NC	FX3U,FX3UC
Communication applicability	✓ (Ver.3.00 or later)	✓ (Ver.1.20 or later)	✓	✓ (Ver.1.06 or later)	✓	✓

2) Non-protocol communication (RS2 instruction)

✓: Applicable (If applicable versions are limited, they are described inside ().)
—: Not applicable

PLC	FX2(FX),FX2C	FX0N	FX1S,FX1N,FX1NC	FX2N	FX2NC	FX3U,FX3UC
Communication applicability	—	—	—	—	—	✓

3) Non-protocol communication (FX2N-232IF)

✓: Applicable (If applicable versions are limited, they are described inside ().)
—: Not applicable

PLC	FX2(FX),FX2C	FX0N	FX1S,FX1N,FX1NC	FX2N	FX2NC	FX3U,FX3UC
Communication applicability	—	—	—	✓	✓	✓

3. Communication targets

Bar code reader, printer, personal computer (micro computer board), measuring instrument, etc.

4. Function

This communication allows non-protocol serial communication with equipment having the RS-232C or RS-422/RS-485 interface.

5. Applications

Communication with a bar code reader, printer, personal computer (micro computer board), measuring instrument, etc.

1.2.7 Programming Communication

→ Refer to the section "Programming Communication."

1. Outline

- 1) Communication equipment operating in accordance with USB (personal computer)

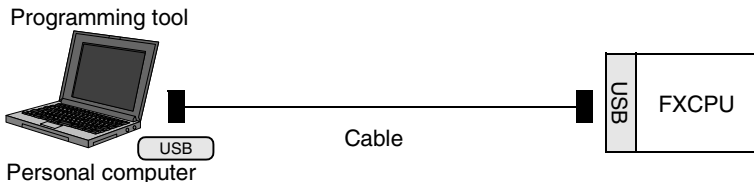

- 2) Communication equipment operating in accordance with RS-422 (programming tool or personal computer)

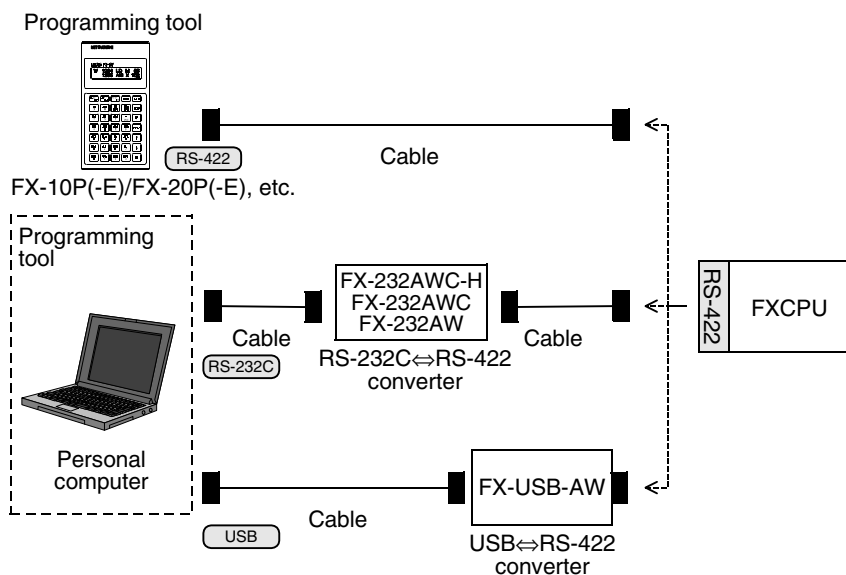

- 3) Communication equipment operating in accordance with RS-232C (personal computer)

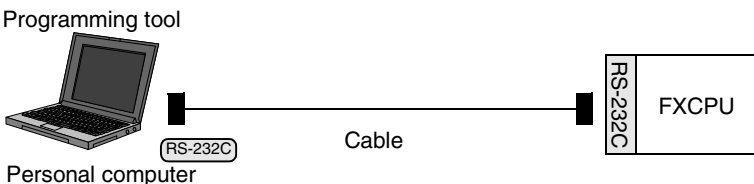

- 4) Standard built-in port in accordance with RS422 (programming tool or personal computer)

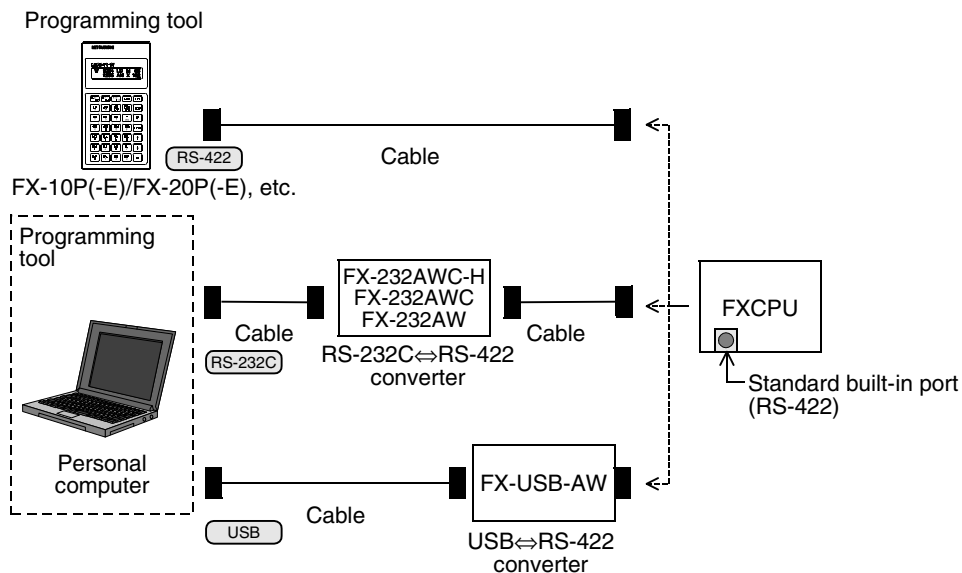

A	Common Items
B	N:N Network
C	Parallel Link
D	Computer Link
E	Inverter Communication
F	Non-Protocol Communication (RS/RS2 Instruction)
G	Non-Protocol Communication (FX2N-232IF)
H	Programming Communication
I	Remote Maintenance

2. Applicable PLCs

✓: Applicable (If applicable versions are limited, they are described inside ().)
 —: Not applicable

PLC	FX2(FX),FX2C	FX0N	FX1S,FX1N	FX1NC	FX2N	FX2NC	FX3U,FX3UC
Communication equipment operating in accordance with USB	—	—	—	—	—	—	✓
Communication equipment operating in accordance with RS-422	—	—	✓	—	✓	—	✓
Communication equipment operating in accordance with RS-232C	—	—	✓	✓	✓	✓	✓
Standard built-in port in accordance with RS-422	✓*1	✓	✓	✓	✓	✓	✓

*1. The FX-USB-AW cannot be connected.

3. Communication targets

Personal computer and programming tool

4. Function

This communication allows connection of a personal computer or programming tool to a standard port built in a PLC or optional connector to execute sequence programs.

5. Applications

- 1) Programs can be changed and monitored using a personal computer or programming tool.
- 2) A personal computer (for changing programs) can be directly connected in accordance with RS-232C.
- 3) While the standard programming connector built in an FX PLC is used for connecting a display unit, a personal computer or programming tool can be connected at the same time for monitoring and transferring data.

1.2.8 Remote Maintenance

→ Refer to the section "Remote Maintenance."

1. Outline

1) Remote access (GX Developer or FXGP/WIN)

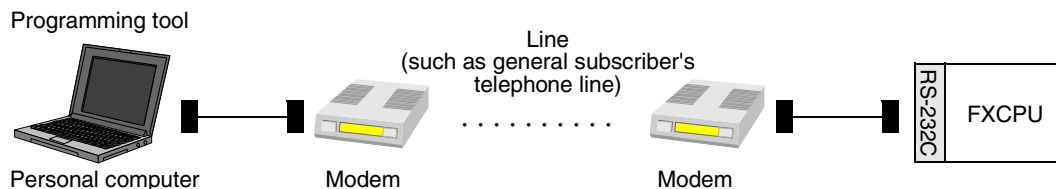

2) File transfer (FXGP/WIN)

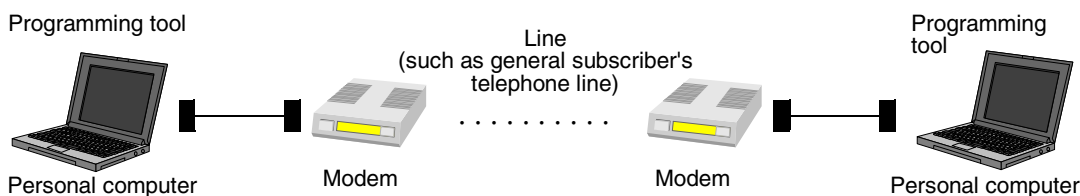

2. Applicable PLCs

✓: Applicable (If applicable versions are limited, they are described inside ().)
—: Not applicable

PLC	FX2(FX),FX2C	FX0N	FX1S,FX1N,FX1NC	FX2N	FX2NC	FX3U,FX3UC
Communication applicability	—	—	✓	✓	✓	✓

3. Communication target

Personal computer (GX Developer or FXGP/WIN)

4. Function

This communication allows connection of a modem on the PLC side to a modem on the personal computer side through a line (cellular phone or general subscriber's telephone line) to achieve monitoring and program transfer from the personal computer.

The FXGP/WIN allows transfer of file data between personal computers.

5. Applications

By this communication, programs in a PLC located in a distant place can be changed and maintained by monitoring.

A	Common Items
B	N:N Network
C	Parallel Link
D	Computer Link
E	Inverter Communication
F	Non-Protocol Communication (RS/RS2 Instruction)
G	Non-Protocol Communication (FX2N-232IF)
H	Programming Communication
I	Remote Maintenance

1.2.9 CC-Link/LT Network

→ For FX3uc built-in CC-Link/LT master, refer to FX3uc Hardware Edition.
→ For the FX2N-64CL-M, refer to the product manual.

1. Outline

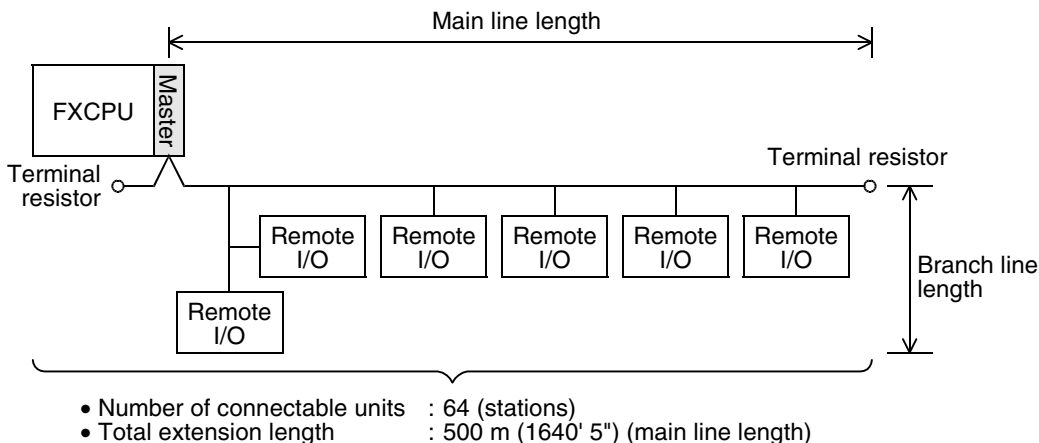

2. Applicable PLCs

✓: Applicable (If applicable versions are limited, they are described inside ().)
—: Not applicable

PLC	FX2(FX),FX2C	FX0N	FX1S	FX1N,FX1NC	FX2N	FX2NC	FX3U,FX3UC
Communication applicability	—	—	—	✓	✓	✓	✓

3. Communication target

Equipment operating in accordance with the CC-Link/LT network standard

4. Function

This network allows remote control of I/O information for sensors, lamps, etc.
Input (X) numbers and output (Y) numbers can be handled, and I/O points can be assigned continuously even if 2-point or 4-point type remote I/O units are used.

5. Applications

Wiring can be saved for inputs and outputs.

6. Detailed information on CC-Link/LT

For product information on CC-Link, refer to the CC-Link Partner Association's homepage or catalogues (issued by the CC-Link Partner Association).

→ CC-Link Partner Association's homepage: <http://www.cc-link.org/>

1.2.10 AS-i system

→ For details, refer to the FX2N-32ASI-M User's Manual.

1. Outline

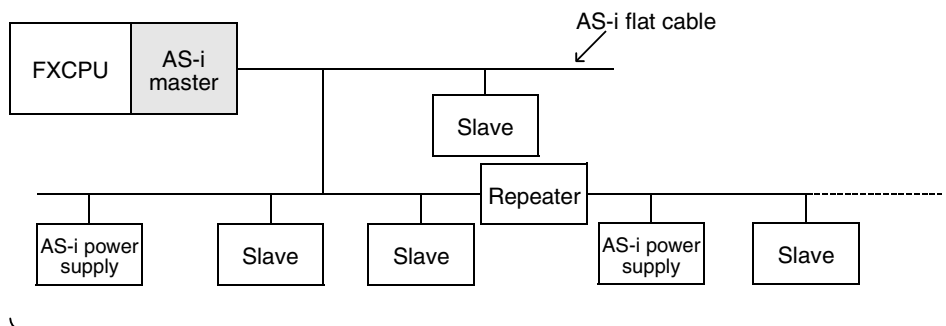

- Number of connectable units : 31 slave units
- Total extension distance : 100 m (328' 1")
[300 m (984' 3") maximum when two repeaters are connected]
- Terminal resistors are not required.

2. Applicable PLCs

✓: Applicable (If applicable versions are limited, they are described inside ().)
—: Not applicable

PLC	FX2(FX),FX2C	FX0N	FX1S	FX1N,FX1NC	FX2N	FX2NC	FX3U,FX3UC
Communication applicability	—	✓	—	✓	✓	✓*1	✓

*1. FX2NC-□MT-D/UL and FX2NC-□M□-DSS(-T-DS) PLCs are not applicable.

3. Communication targets

Slave units (sensors and actuators) for AS-i

4. Function

This network allows remote control of I/O information for sensors and actuators (slave units). The automatic address assignment function enables easy replacement of a slave unit when it has failed.

5. Applications

Wiring can be saved for inputs and outputs.

A	Common Items
B	N:N Network
C	Parallel Link
D	Computer Link
E	Inverter Communication
F	Non-Protocol Communication (RS/RS2 Instruction)
G	Non-Protocol Communication (FX2N-232IF)
H	Programming Communication
I	Remote Maintenance

1.2.11 Internet Mail Sending

→ For the details, refer to the FX-232DOPA USERS MANUAL.

1. Outline

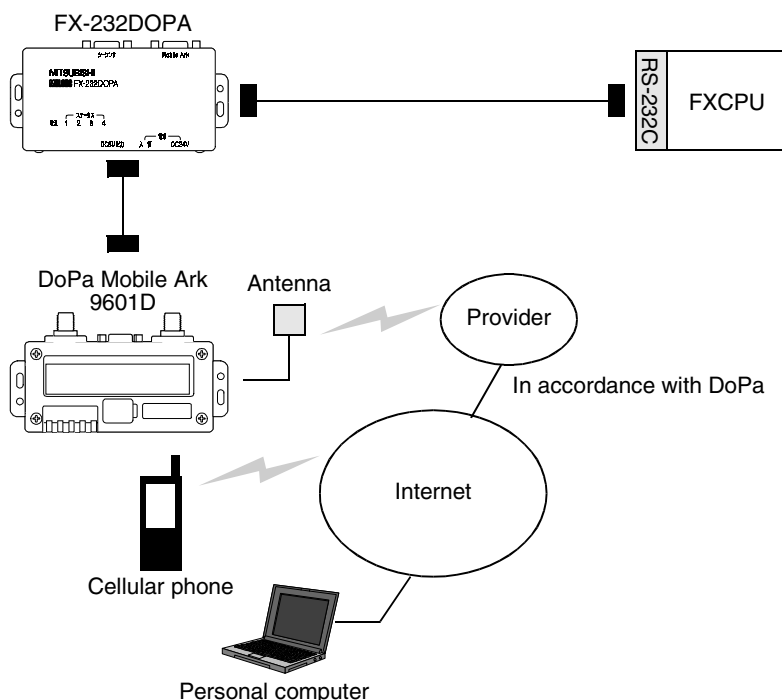

2. Applicable PLCs

✓: Applicable (If applicable versions are limited, they are described inside ().)
—: Not applicable

PLC	FX2(FX),FX2C	FX0N	FX1S	FX1N,FX1NC	FX2N	FX2NC	FX3U,FX3UC
Communication applicability	—	—	✓	✓	✓	✓	✓

3. Communication targets

Personal computer and cellular phone which can receive internet mails

4. Function

This setting sends an electronic mail from a PLC to notify the facility operation status, etc. to a personal computer or cellular phone which can receive electronic mails.

This function is applicable through dial-up connection to a mail server using a combination of FX-232DOPA and DoPa Mobile Ark9601D by NTT DoCoMo.

5. Applications

Monitoring of unmanned facilities, monitoring of facilities located in distant places, monitoring of facilities inside factories and distribution of logging data

1.2.12 Short Mail Sending

→ For details, refer to the FX1S/FX1N/FX2N/FX1NC/FX2NC PLC PROGRAMMING MANUAL

1. Outline

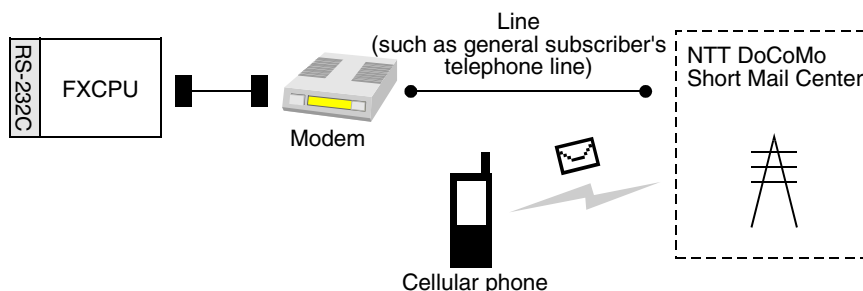

2. Applicable PLCs

✓: Applicable (If applicable versions are limited, they are described inside ().)
—: Not applicable

PLC	FX2(FX),FX2C	FX0N	FX1S	FX1N,FX1NC	FX2N	FX2NC	FX3U,FX3UC
Communication applicability	—	—	—	—	✓ (Ver.3.00 or later)	✓ (Ver.3.00 or later)	—

3. Communication targets

Cellular phones by NTT DoCoMo with a contract for i-mode or short mail

4. Function

This function sends a short mail from a PLC to notify the facility operation status, etc. to a cellular phone by NTT DoCoMo which can receive short mails.

This function is applicable through connection in a line to a Short Mail Center of NTT DoCoMo.

5. Applications

Monitoring of unmanned facilities, monitoring of facilities located in distant places and monitoring of facilities in factories

A

Common Items

B

N:N Network

C

Parallel Link

D

Computer Link

E

Inverter Communication

F

Non-Protocol Communication (RS/RS2 Instruction)

G

Non-Protocol Communication (FX2N-232IF)

H

Programming Communication

I

Remote Maintenance

MEMO

2. Communication Types and Communication Equipment

This chapter explains which communication types are supported by serial ports of communication equipment and connectors of networks.

For the communication equipment required in the system configuration, refer to a description later.

→ Refer to "2.3 Combination of Communication Equipment (Block Diagram)."

2.1 Relationship between Equipment and Communication Types

The figure below shows the relationship between communication equipment and communication types:

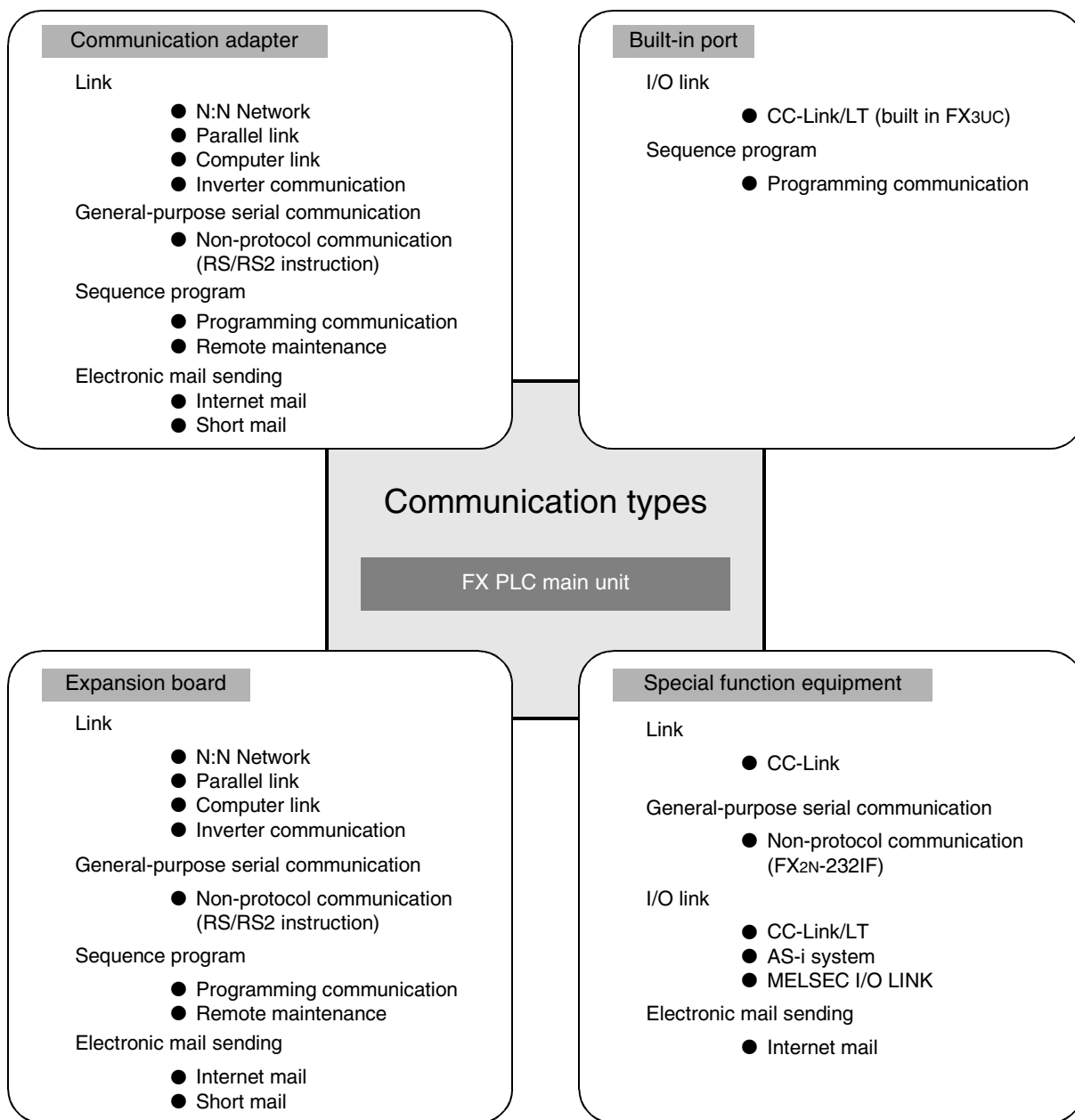

A	Common Items
B	N:N Network
C	Parallel Link
D	Computer Link
E	Inverter Communication
F	Non-Protocol Communication (RS/RS2 Instruction)
G	Non-Protocol Communication (FX2N-232IF)
H	Programming Communication
I	Remote Maintenance

2.2 Communication Equipment Applicability Map

The table below shows the communication types applicable in each FX Series and includes the supporting communication equipment. The communication types can be used when a built-in port or piece of communication equipment is connected, but some of them may not be applicable at the same time.

2.2.1 FX3U and FX3UC PLCs

PLC	Communication equipment Product inside () is essential.	Communication specifications	Link					
			CC-Link	N:N Network	Parallel link	Computer link		
Manual name (Obtain manuals if necessary.) →			Each product manual	This manual	This manual	This manual		
FX3U PLC	FX3U-USB-BD	USB	—	—	—	—		
	FX3U-232-BD	RS-232C		—	—	✓		
	FX3U-232ADP(expansion board)			—	—	✓		
	FX2N-232IF			—	—	—		
	FX3U-485-BD	RS-485		✓*1	✓*1	✓		
	FX3U-485ADP(expansion board)			✓*1	✓*1	✓		
	FX3U-422-BD	RS-422		—	—	—		
	Standard built-in port			—	—	—		
	FX2N-16CCL-M	—		✓*4	—	—	—	
	FX2N-32CCL			✓				
	FX2N-64CL-M			—				
	FX2N-32ASI-M			—				
	FX2N-16LNK-M			—				
FX3UC PLC	FX3U-USB-BD	USB	—	—	—	—		
	FX3U-232-BD	RS-232C		—	—	✓		
	FX3U-232ADP(expansion board)			—	—	✓		
	FX2N-232IF (FX2NC-CNV-IF or FX3UC-1PS-5V)			—	—	—		
	FX3U-485-BD	RS-485		✓*1	✓*1	✓		
	FX3U-485ADP(expansion board)			✓*1	✓*1	✓		
	FX3U-422-BD	RS-422		—	—	—		
	Standard built-in port			—	—	—		
	FX2N-16CCL-M (FX2NC-CNV-IF or FX3UC-1PS-5V)	—		✓*4	—	—	—	
	FX2N-32CCL (FX2NC-CNV-IF or FX3UC-1PS-5V)			✓				
	FX2N-64CL-M (FX2NC-CNV-IF or FX3UC-1PS-5V)			—				
	Built-in type CC-Link/LT master			—				
	FX2N-32ASI-M (FX2NC-CNV-IF or FX3UC-1PS-5V)			—				

- *1. Two channels cannot be set at the same time in N:N Network and parallel link.
N:N Network and parallel link cannot be used together.
- *2. For the FX2N-64CL-M, refer to FX2N-64CL-M User's Manual.
For FX3UC built-in CC-Link/LT master, refer to FX3UC Hardware Edition.
- *3. Two channels cannot be set at the same time in remote maintenance.
- *4. The FX2N-16CCL-M and FX2N-32ASI-M cannot be used at the same time.

Link		General-purpose communication	I/O link			Sequence program		Mail sending
	Inverter communication	Non-protocol communication	CC-Link/LT	AS-i system	MELSEC-I/O LINK	Programming	Remote maintenance	Internet mail sending
	This manual	This manual	Each product manual	Each product manual	Each product manual	This manual	This manual	FX-232DOPA User's Manual
	—	—				✓	—	—
	—	✓				✓	✓*3	✓
	—	✓				✓	✓*3	✓
	—	✓				—	—	✓
	✓	✓				—	—	—
	✓	✓				—	—	—
	—	—				✓	—	—
	—	—				✓	—	—
			—	—	—			
			—	—	—			
			✓*2	—	—			
			—	✓*4	—			
			—	—	✓			
	—	—				✓	—	—
	—	✓				✓	✓*3	✓
	—	✓				✓	✓*3	✓
	—	✓				—	—	✓
	✓	✓				—	—	—
	✓	✓				—	—	—
	—	—				✓	—	—
	—	—				✓	—	—
			—	—	—			
			—	—	—			
			✓*2	—	—			
			✓*2	—	—			
			—	✓*4	—			

A	Common Items
B	N:N Network
C	Parallel Link
D	Computer Link
E	Inverter Communication
F	Non-Protocol Communication (RS/RS2 Instruction)
G	Non-Protocol Communication (FX2N-232IF)
H	Programming Communication
I	Remote Maintenance

2.2.2 FX2N and FX2NC PLCs

PLC	Communication equipment Product inside () is essential.	Communication specifications	Link					
			CC-Link	N:N Network	Parallel link	Computer link		
Manual name (Obtain manuals if necessary.) →			Each product manual	This manual	This manual	This manual		
FX2N PLC	FX2N-232-BD	RS-232C	—	—	—	✓		
	FX2NC-232ADP(FX2N-CNV-BD)			—	—	✓		
	FX0N-232ADP(FX2N-CNV-BD)			—	—	✓*1		
	FX2N-232IF			—	—	—		
	FX2N-485-BD	RS-485		✓	✓	✓		
	FX2NC-485ADP(FX2N-CNV-BD)			✓	✓	✓		
	FX0N-485ADP(FX2N-CNV-BD)			✓	✓	✓		
	FX2N-422-BD	RS-422		—	—	—		
	Standard built-in port			—	—	—		
	FX2N-16CCL-M	—		✓*3	—			
	FX2N-32CCL			✓				
	FX2N-64CL-M			—				
	FX2N-32ASI-M			—				
	FX2N-16LNK-M			—				
FX2NC PLC	FX2NC-232ADP	RS-232C	—	—	—	✓		
	FX0N-232ADP			—	—	✓*1		
	FX2N-232IF(FX2NC-CNV-IF)			—	—	—		
	FX2NC-485ADP	RS-485		✓	✓	✓		
	FX0N-485ADP			✓	✓	✓		
	Standard built-in port	RS-422		—	—	—		
	FX2N-16CCL-M(FX2NC-CNV-IF)	—		✓*3	—			
	FX2N-32CCL(FX2NC-CNV-IF)			✓				
	FX2N-64CL-M(FX2NC-CNV-IF)			—				
	FX2N-32ASI-M(FX2NC-CNV-IF)			—				
FX2N-16LNK-M(FX2NC-CNV-IF)	—							

- *1. It is recommended to use a connector or thin type FX2NC-232ADP (9-pin D-Sub).
- *2. The FX2NC Series main unit does not support connection of the FX2NC-□MT-D/UL and FX2NC-□M□-DSS(-T-DS).
- *3. The FX2N-16CCL-M and FX2N-32ASI-M cannot be used at the same time.

Link		General-purpose communication	I/O link			Sequence program		Mail sending				
	Inverter communication	Non-protocol communication	CC-Link/LT	AS-i system	MELSEC-I/O LINK	Programming	Remote maintenance	Internet mail sending	Short mail sending			
	This manual	This manual	Each product manual	Each product manual	Each product manual	This manual	This manual	FX-232DOPA User's Manual	FX1S, FX1N, FX2N, FX1NC, FX2NC Programming Manual			
	—	✓				✓	✓	✓	✓			
	—	✓				✓	✓	✓	✓	✓	✓	
	—	✓ ^{*1}				✓ ^{*1}	✓ ^{*1}	✓ ^{*1}	✓ ^{*1}	✓ ^{*1}	✓ ^{*1}	
	—	✓				—	—	—	—	—	—	
	✓	✓				—	—	—	—	—	—	
	✓	✓				—	—	—	—	—	—	
	—	—				✓	—	—	—	—	—	
	—	—				✓	—	—	—	—	—	
						—	—	—				
						—	—	—				
			✓	—	—							
			—	✓ ^{*3}	—							
			—	—	✓							
	—	✓				✓	✓	✓	✓			
	—	✓ ^{*1}				✓ ^{*1}	✓ ^{*1}	✓ ^{*1}	✓ ^{*1}	✓ ^{*1}	✓ ^{*1}	
	—	✓				—	—	—	—	—	—	
	✓	✓				—	—	—	—	—	—	
	✓	✓				—	—	—	—	—	—	
	—	—				✓	—	—	—	—	—	
			—	—	—							
			—	—	—							
			✓	—	—							
			—	✓ ^{*2*3}	—							
			—	—	✓							

A	Common Items
B	N:N Network
C	Parallel Link
D	Computer Link
E	Inverter Communication
F	Non-Protocol Communication (RS/RS2 Instruction)
G	Non-Protocol Communication (FX2N-232IF)
H	Programming Communication
I	Remote Maintenance

2.2.3 FX1S, FX1N, and FX1NC PLCs

PLC	Communication equipment Product inside () is essential.	Communication specifications	Link					
			CC-Link	N:N Network	Parallel link	Computer link		
Manual name (Obtain manuals if necessary.) →			Each product manual	This manual	This manual	This manual		
FX1S PLC	FX1N-232-BD	RS-232C	—	—	—	✓		
	FX2NC-232ADP(FX1N-CNV-BD)			—	—	✓		
	FX0N-232ADP(FX1N-CNV-BD)			—	—	✓ ^{*1}		
	FX1N-485-BD	RS-485		✓	✓	✓		
	FX2NC-485ADP(FX1N-CNV-BD)			✓	✓	✓		
	FX0N-485ADP(FX1N-CNV-BD)			✓	✓	✓		
	FX1N-422-BD	RS-422		—	—	—		
	Standard built-in port			—	—	—		
FX1N PLC	FX1N-232-BD	RS-232C	—	—	—	✓		
	FX2NC-232ADP(FX1N-CNV-BD)			—	—	✓		
	FX0N-232ADP(FX1N-CNV-BD)			—	—	✓ ^{*1}		
	FX1N-485-BD	RS-485		✓	✓	✓		
	FX2NC-485ADP(FX1N-CNV-BD)			✓	✓	✓		
	FX0N-485ADP(FX1N-CNV-BD)			✓	✓	✓		
	FX1N-422-BD	RS-422		—	—	—		
	Standard built-in port			—	—	—		
	FX2N-16CCL-M	—		✓ ^{*2}	—			
	FX2N-32CCL			✓				
	FX2N-64CL-M			—				
	FX2N-32ASI-M			—				
	FX2N-16LNK-M			—				
FX1NC PLC	FX2NC-232ADP	RS-232C	—	—	—	✓		
	FX0N-232ADP			—	—	✓ ^{*1}		
	FX2NC-485ADP	RS-485		✓	✓	✓		
	FX0N-485ADP			✓	✓	✓		
	Standard built-in port	RS-422		—	—	—		
	FX2N-16CCL-M(FX2NC-CNV-IF)	—		✓ ^{*2}	—			
	FX2N-32CCL(FX2NC-CNV-IF)			✓				
	FX2N-64CL-M(FX2NC-CNV-IF)			—				
	FX2N-32ASI-M(FX2NC-CNV-IF)			—				
	FX2N-16LNK-M(FX2NC-CNV-IF)			—				

*1. It is recommended to use a connector or thin type FX2NC-232ADP (9-pin D-Sub).

*2. The FX2N-16CCL-M and FX2N-32ASI-M cannot be used at the same time.

Link		General-purpose communication	I/O link			Sequence program		Mail sending		
Inverter communication	Non-protocol communication	CC-Link/LT	AS-i system	MELSEC-I/O LINK	Programming	Remote maintenance	Internet mail sending			
This manual	This manual	Each product manual	Each product manual	Each product manual	This manual	This manual	FX-232DOPA User's Manual			
—	✓				✓	✓	✓			
—	✓				✓	✓	✓			
—	✓ ^{*1}				✓ ^{*1}	✓ ^{*1}	✓ ^{*1}			
—	✓				—	—	—			
—	✓				—	—	—			
—	✓				—	—	—			
—	—				✓	—	—			
—	—				✓	—	—			
—	✓							✓	✓	✓
—	✓							✓	✓	✓
—	✓ ^{*1}	✓ ^{*1}	✓ ^{*1}	✓ ^{*1}						
—	✓	—	—	—						
—	✓	—	—	—						
—	✓	—	—	—						
—	—	✓	—	—						
—	—	✓	—	—						
—	—	—	—	—						
—	—	—	—	—						
		—	—	—						
		—	—	—						
		✓	—	—						
		—	✓ ^{*2}	—						
		—	—	✓						
					✓	✓	✓			
					✓ ^{*1}	✓ ^{*1}	✓ ^{*1}			
					—	—	—			
					—	—	—			
					—	—	—			
								—	—	—
								—	—	—
								✓	—	—
								—	✓ ^{*2}	—
								—	—	—
								—	—	—
								—	—	—
								—	—	✓

A	Common Items
B	N:N Network
C	Parallel Link
D	Computer Link
E	Inverter Communication
F	Non-Protocol Communication (RS/RS2 Instruction)
G	Non-Protocol Communication (FX2N-232IF)
H	Programming Communication
I	Remote Maintenance

2.2.4 FX0N PLCs

PLC	Communication equipment Product inside () is essential.	Communication specifications	Link			
			CC-Link	N:N Network	Parallel link	Computer link
Manual name (Obtain manuals if necessary.) →			Each product manual	This manual	This manual	This manual
FX0N PLC	FX2NC-232ADP	RS-232C		—	—	✓
	FX0N-232ADP			—	—	✓*1
	FX2NC-485ADP	RS-485		✓	✓	✓
	FX0N-485ADP			✓	✓	✓
	Standard built-in port	RS-422		—	—	—
	FX2N-16CCL-M	—		—		
	FX2N-32CCL			✓		
	FX2N-64CL-M			—		
	FX2N-32ASI-M			—		
	FX2N-16LNK-M			—		

*1. It is recommended to use a connector or thin type FX2NC-232ADP (9-pin D-Sub).

2.2.5 FX0, FX0s, FX2(FX), FX2c, and FX1 PLCs (reference)

PLC	Communication equipment Product inside () is essential.	Communication specifications	Link			
			CC-Link	N:N Network	Parallel link	Computer link
Manual name (Obtain manuals if necessary.) →			Each product manual	This manual	This manual	This manual
FX0 PLC	Standard built-in port	RS-422		—	—	—
FX0s PLC	Standard built-in port	RS-422		—	—	—
FX2c PLC FX2(FX) PLC	FX-232ADP	RS-232C		—	—	✓
	FX-485ADP	RS-485		—	—	✓
	FX-40AW	—		—	✓	—
	FX-40AP	Optical communication		—	✓	—
	Standard built-in port	RS-422		—	—	—
FX1 PLC	Standard built-in port	RS-422		—	—	—

Link		General-purpose communication	I/O link			Sequence program		Mail sending	
	Inverter communication	Non-protocol communication	CC-Link/LT	AS-i system	MELSEC-I/O LINK	Programming	Remote maintenance	Internet mail sending	
	This manual	This manual	Each product manual	Each product manual	Each product manual	This manual	This manual	FX-232DOPA User's Manual	
	—	✓				—	—	—	
	—	✓*1				—	—	—	—
	—	✓				—	—	—	—
	—	✓				—	—	—	—
	—	—				—	—	✓	—
			—	—	—				
			—	—	—				
			✓	—	—				
			—	✓	—				
			—	—	✓				

Link		General-purpose communication	I/O link			Sequence program		Mail sending	
	Inverter communication	Non-protocol communication	CC-Link/LT	AS-i system	MELSEC-I/O LINK	Programming	Remote maintenance	Internet mail sending	
	This manual	This manual	Each product manual	Each product manual	Each product manual	This manual	This manual	FX-232DOPA User's Manual	
	—	—				✓	—	—	
	—	—				✓	—	—	—
	—	✓				—	—	—	—
	—	—				—	—	—	—
	—	—				—	—	—	—
	—	—	—	—	—	✓	—	—	
	—	—				✓	—	—	

A	Common Items
B	N:N Network
C	Parallel Link
D	Computer Link
E	Inverter Communication
F	Non-Protocol Communication (RS/RS2 Instruction)
G	Non-Protocol Communication (FX2N-232IF)
H	Programming Communication
I	Remote Maintenance

2.3 Combination of Communication Equipment (Block Diagram)

The block diagram below shows combinations of optional communication equipment applicable in each FX Series.

2.3.1 How to look at combination pages

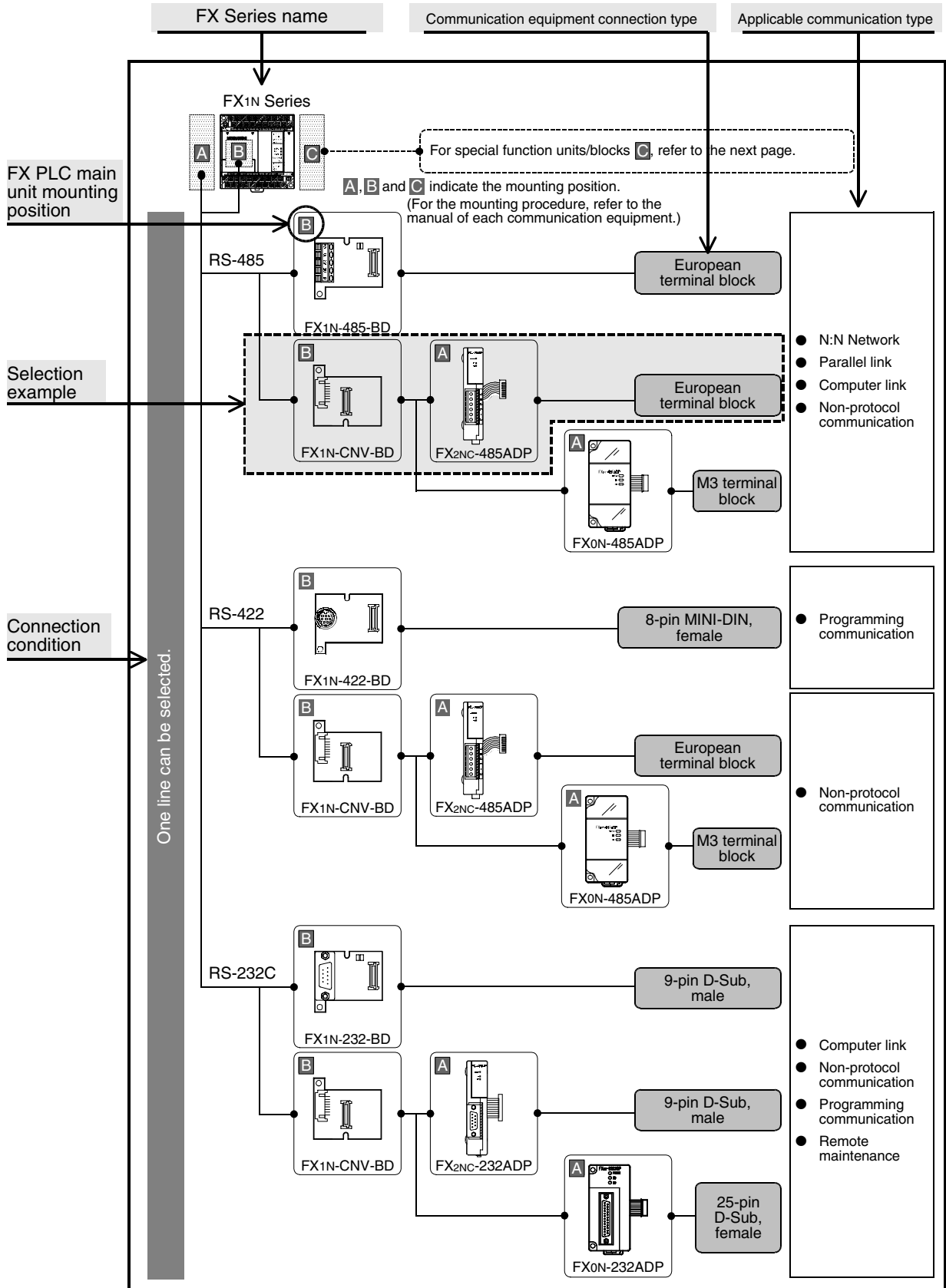

2.3.2 For FX0N Series

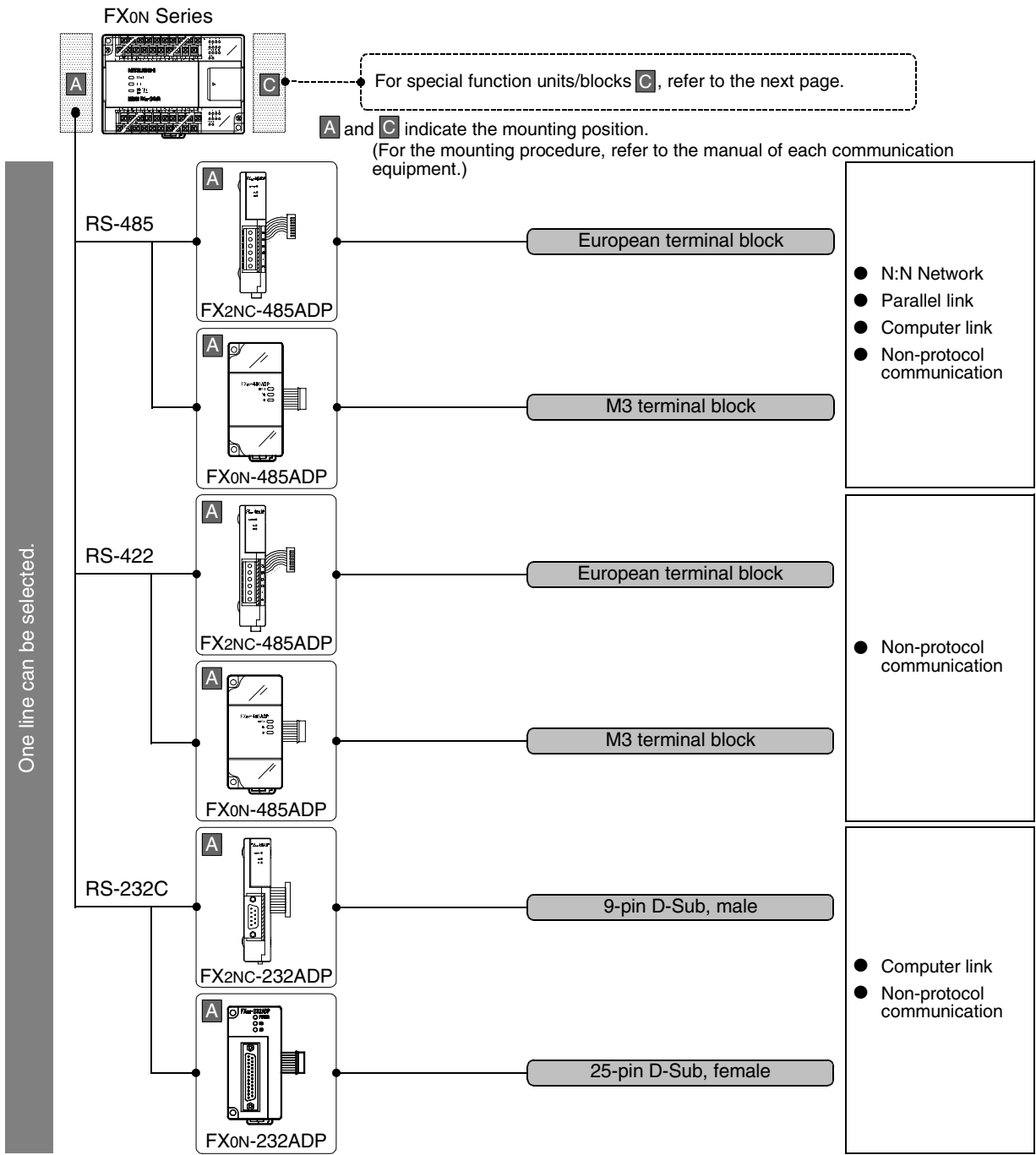

A	Common Items
B	N:N Network
C	Parallel Link
D	Computer Link
E	Inverter Communication
F	Non-Protocol Communication (RS/RS2 Instruction)
G	Non-Protocol Communication (FX2N-232IF)
H	Programming Communication
I	Remote Maintenance

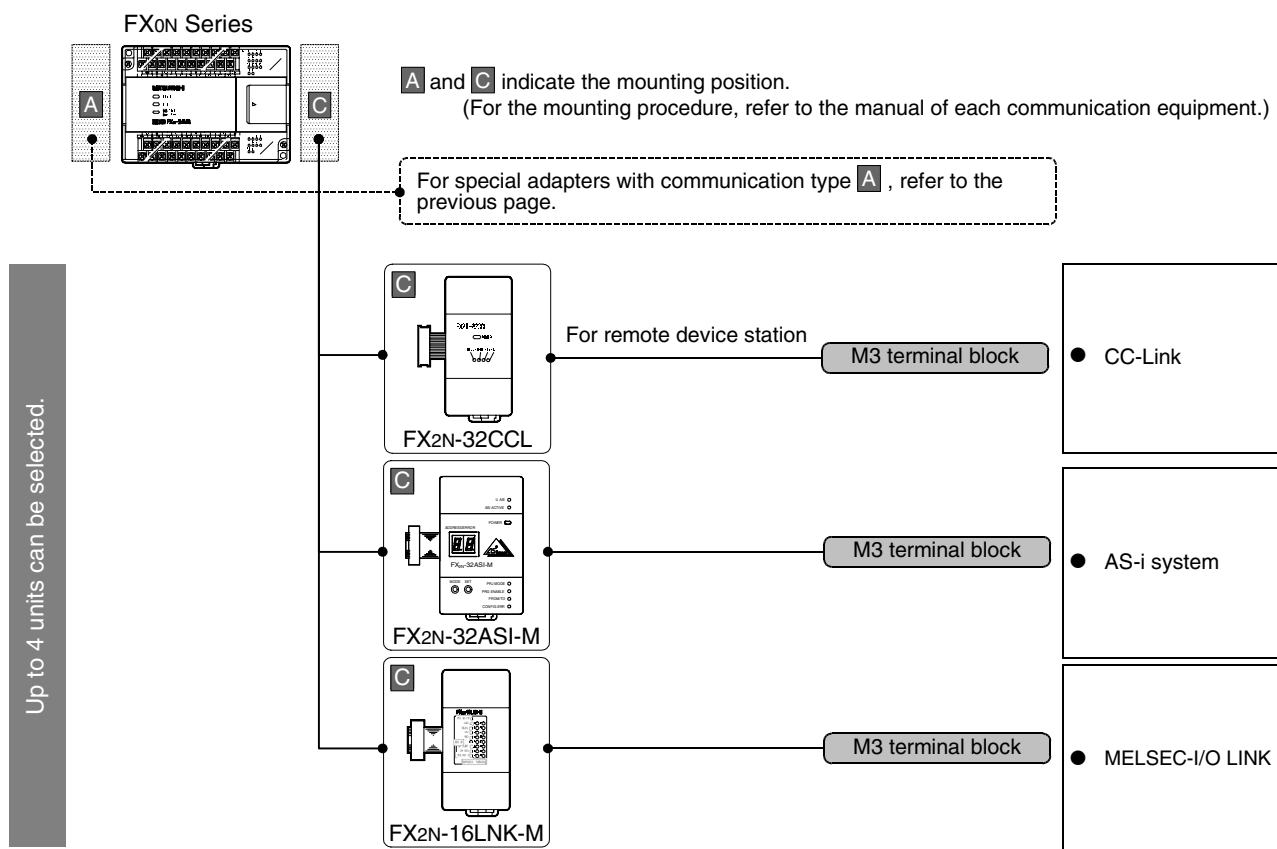

Limitation in the number of connectable units

Connected special function units/blocks operate using the 24V DC or 5V DC power supply of the PLC. Accordingly, when the total current consumption is larger than the current capacity of the PLC, the number of connectable units must be reduced.

→ For details, refer to the manual of each FX PLC.

2.3.3 For FX1s Series

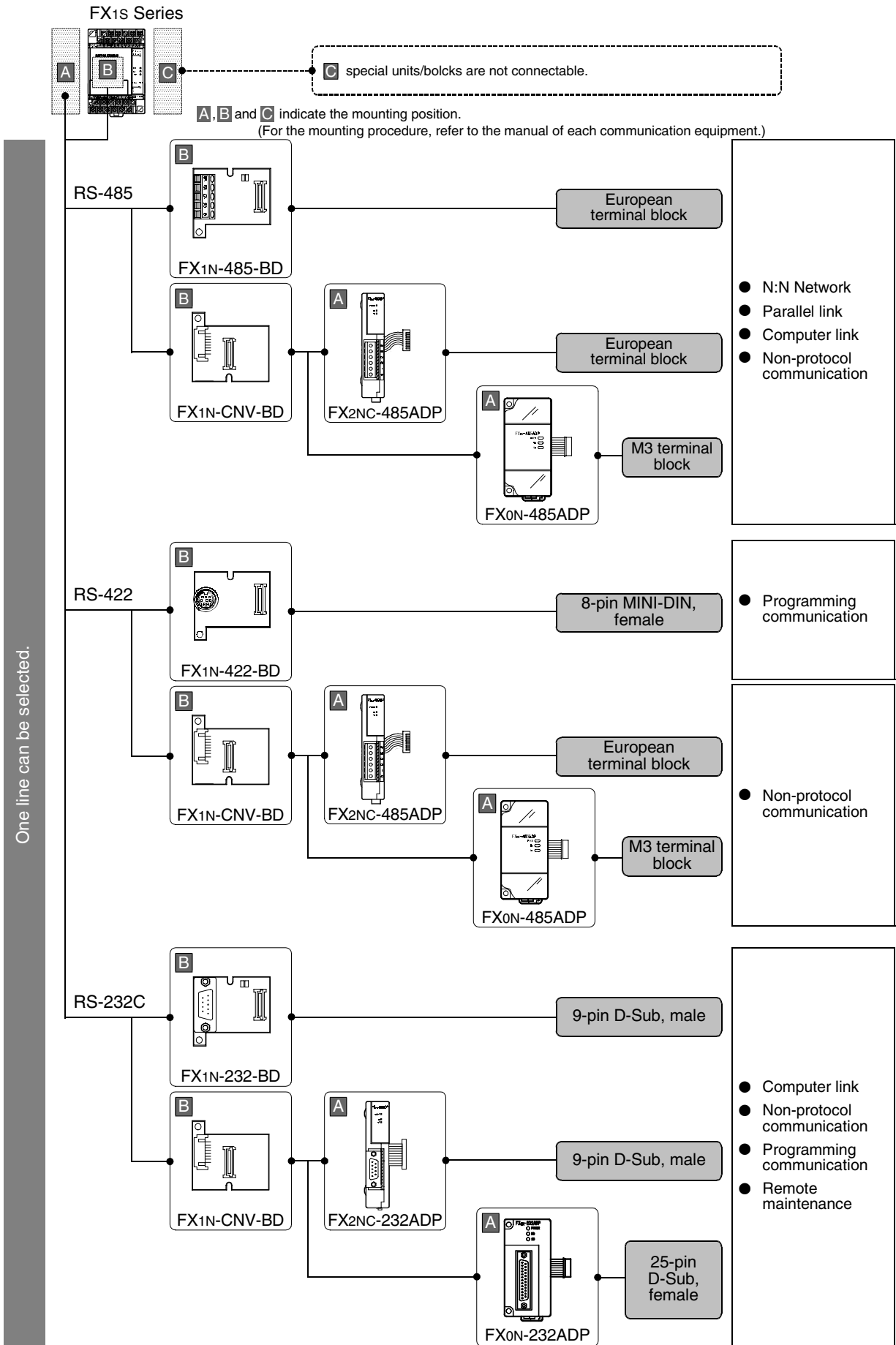

A	Common Items
B	N:N Network
C	Parallel Link
D	Computer Link
E	Inverter Communication
F	Non-Protocol Communication (RS/RSS2 Instruction)
G	Non-Protocol Communication (FX2N-232IF)
H	Programming Communication
I	Remote Maintenance

2.3.4 For FX1N Series

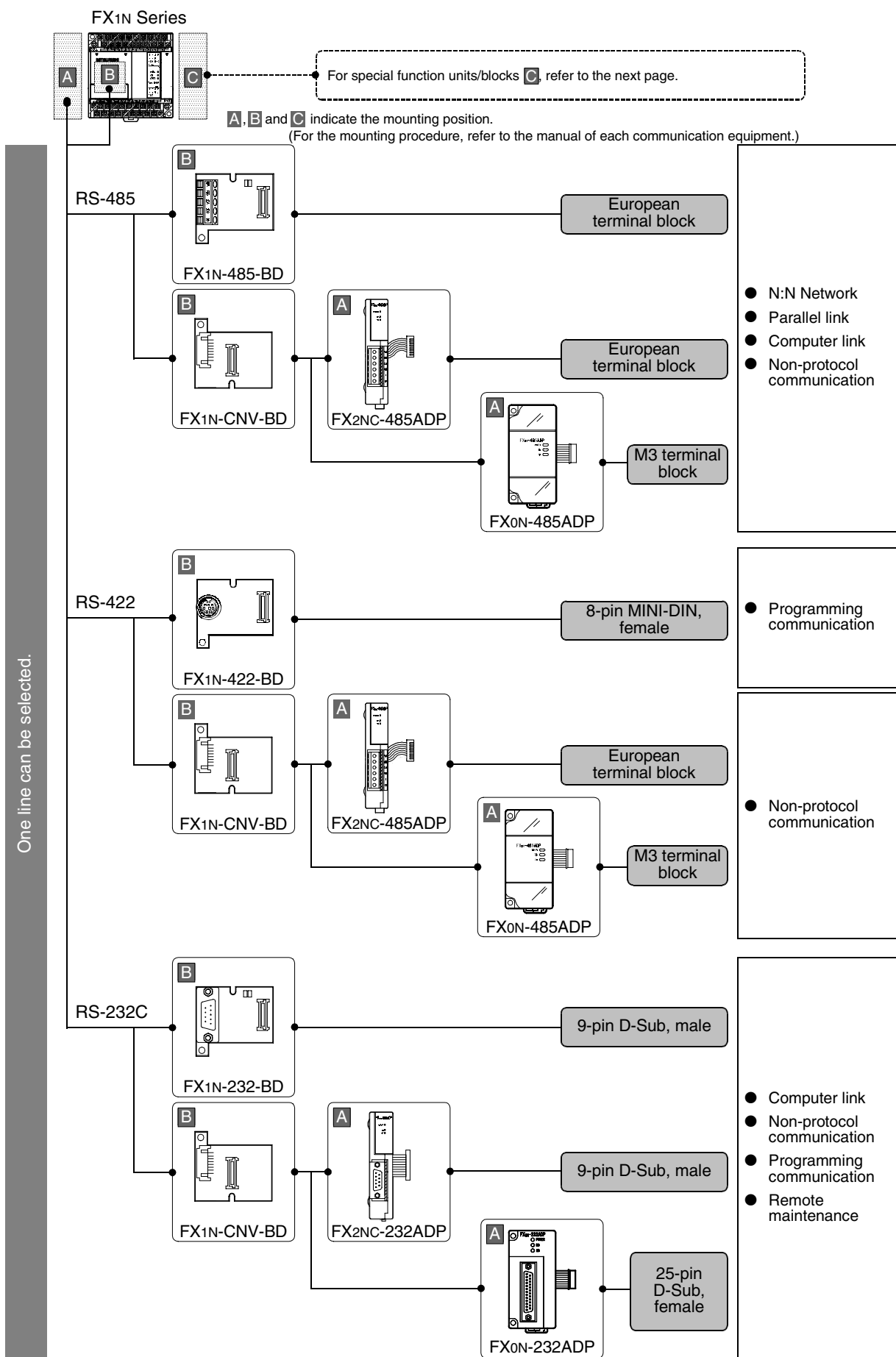

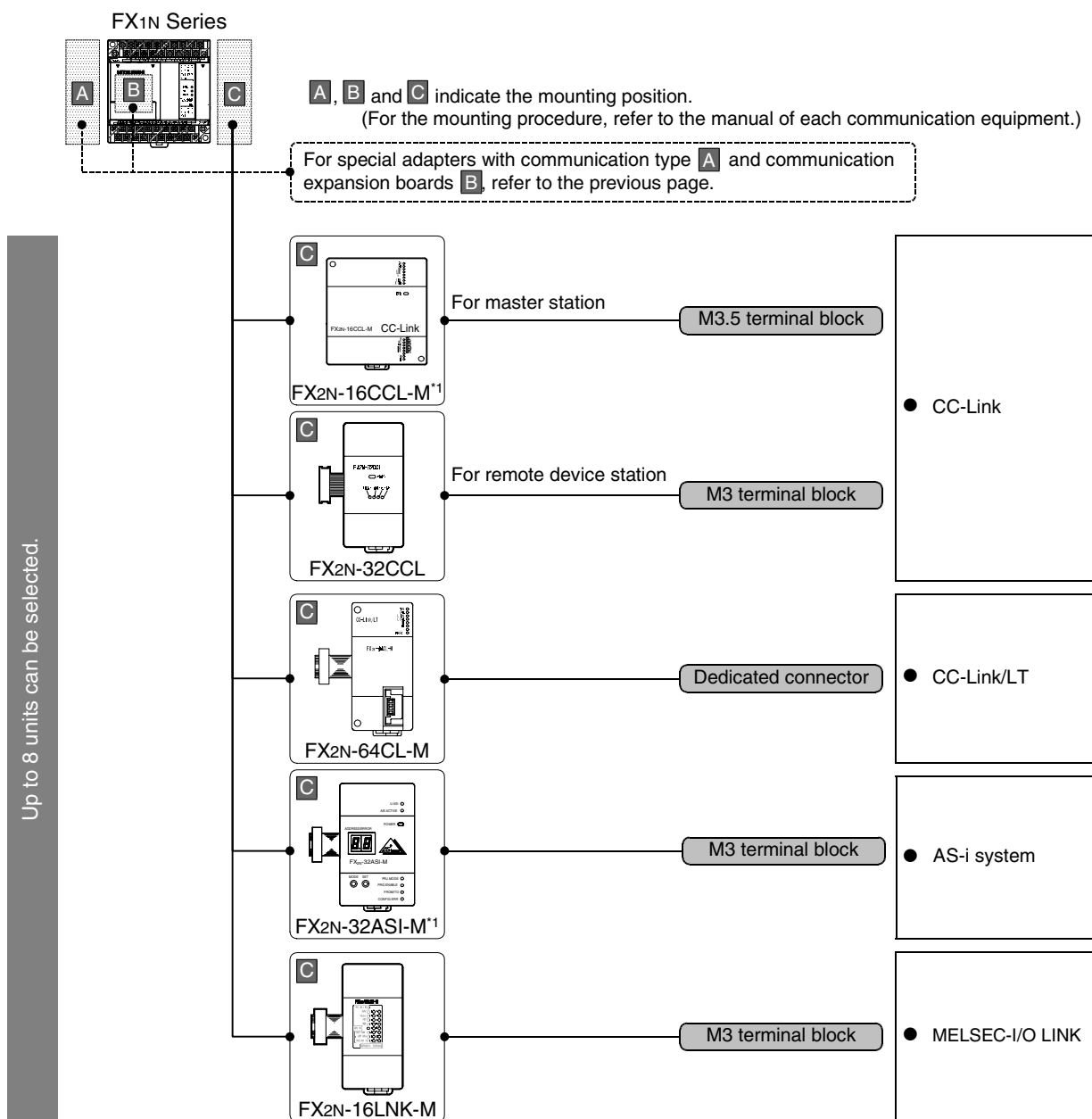

*1. The FX2N-16CCL-M and FX2N-32ASI-M cannot be used at the same time.

Limitation in the number of connectable units

Connected special function units/blocks operate using the 24V DC or 5V DC power supply of the PLC. Accordingly, the number of connectable units depends on the system configuration.

→ For details, refer to the manual of each FX PLC.

A	Common Items
B	N:N Network
C	Parallel Link
D	Computer Link
E	Inverter Communication
F	Non-Protocol Communication (RS/RS2 Instruction)
G	Non-Protocol Communication (FX2N-232IF)
H	Programming Communication
I	Remote Maintenance

2.3.5 For FX1NC Series

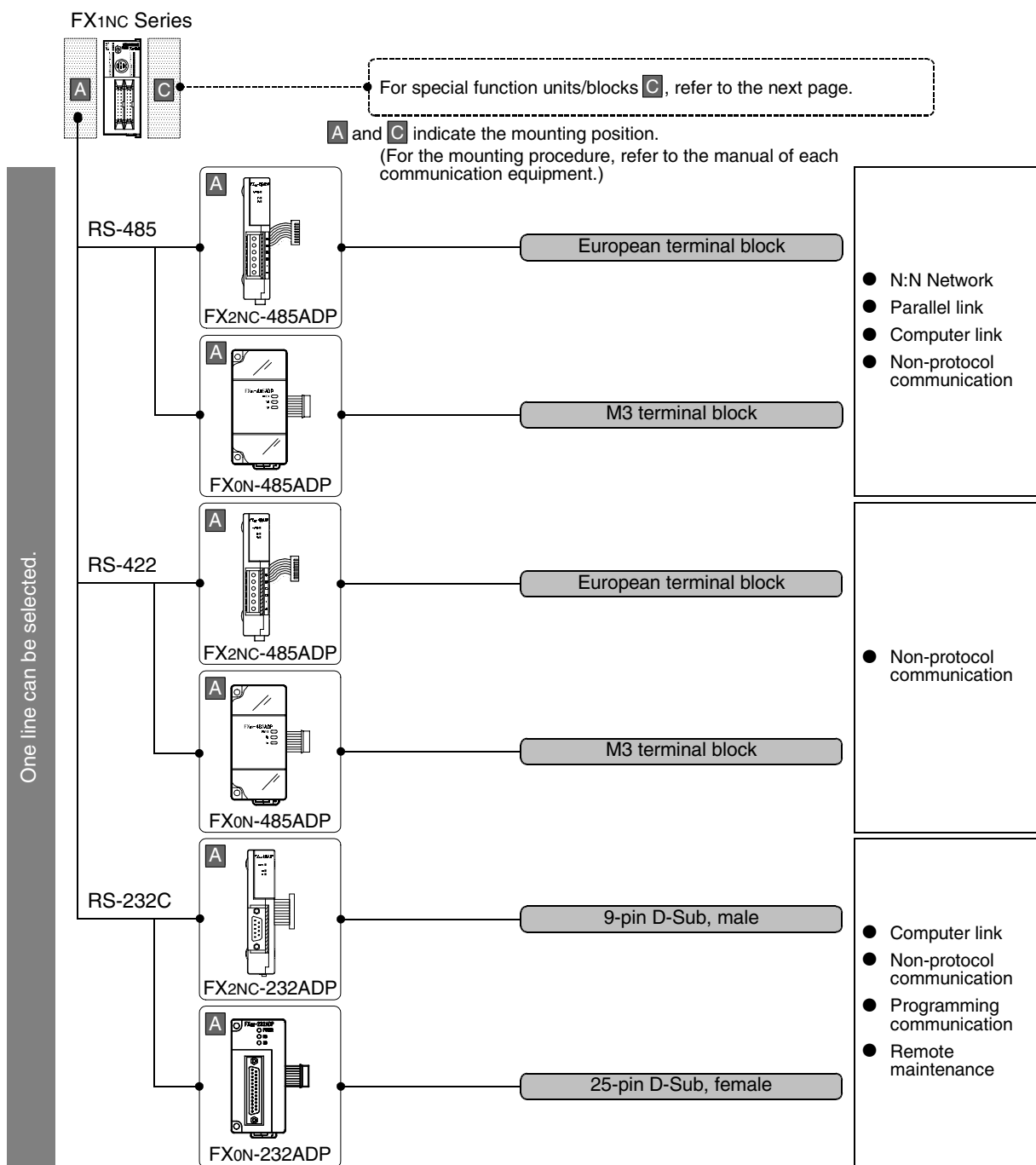

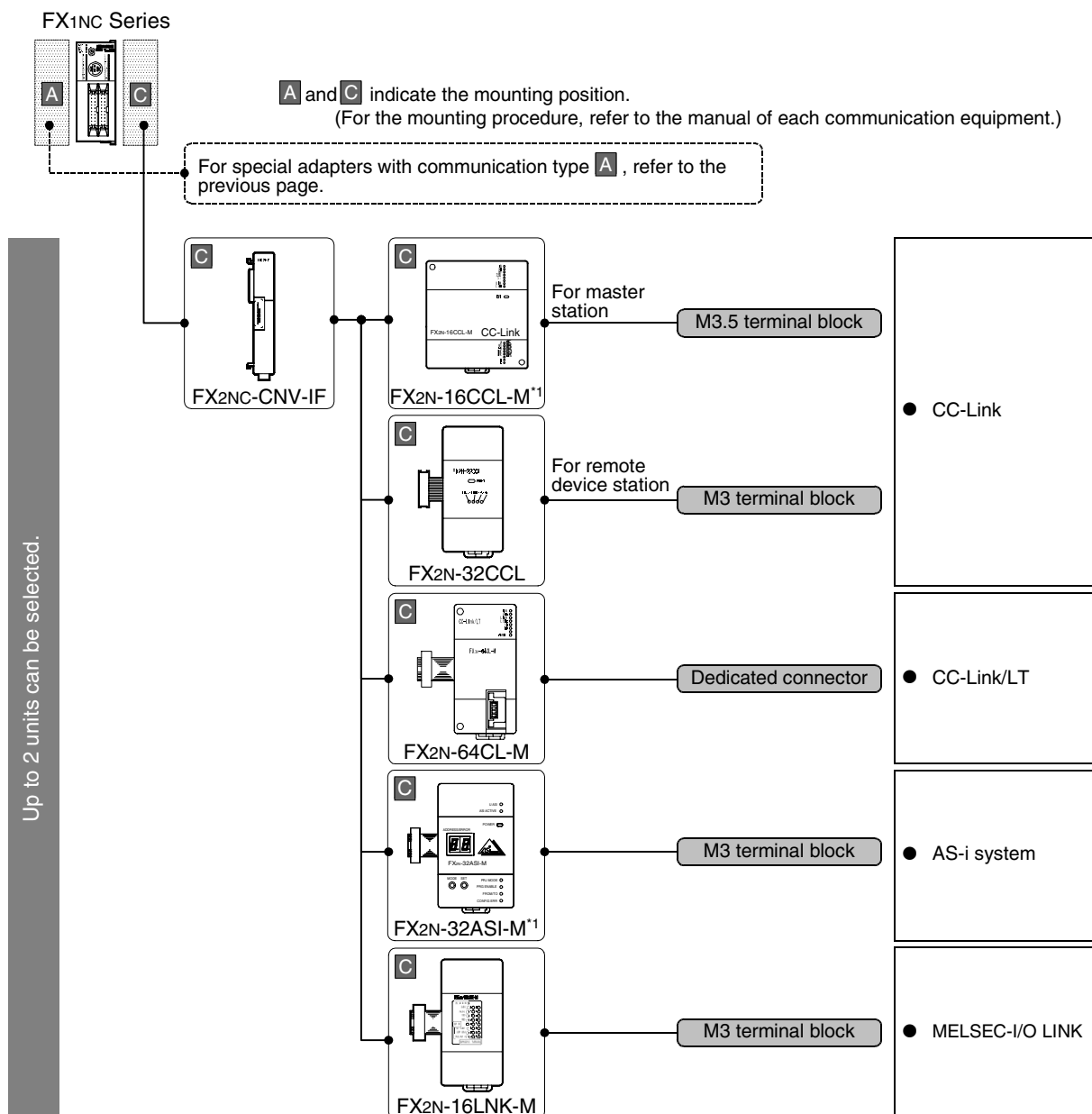

*1. The FX2N-16CCL-M and FX2N-32ASI-M cannot be used at the same time.

Limitation in the number of connectable units

Connected special function units/blocks operate using the 24V DC or 5V DC power supply of the PLC. Accordingly, the number of connectable units depends on the system configuration.

→ For details, refer to the manual of each FX PLC.

A	Common Items
B	N:N Network
C	Parallel Link
D	Computer Link
E	Inverter Communication
F	Non-Protocol Communication (RS/RS2 Instruction)
G	Non-Protocol Communication (FX2N-232IF)
H	Programming Communication
I	Remote Maintenance

2.3.6 For FX2N Series

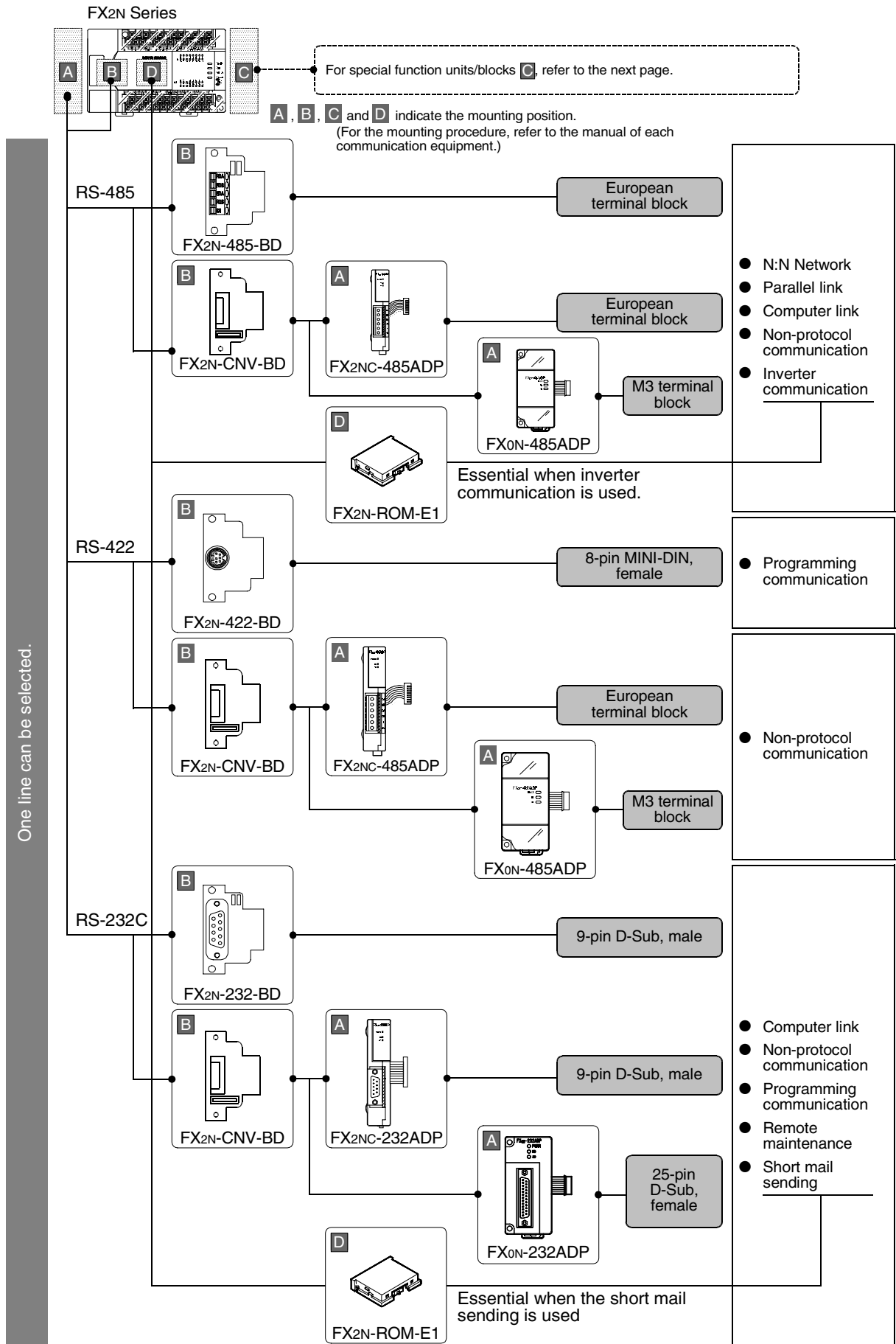

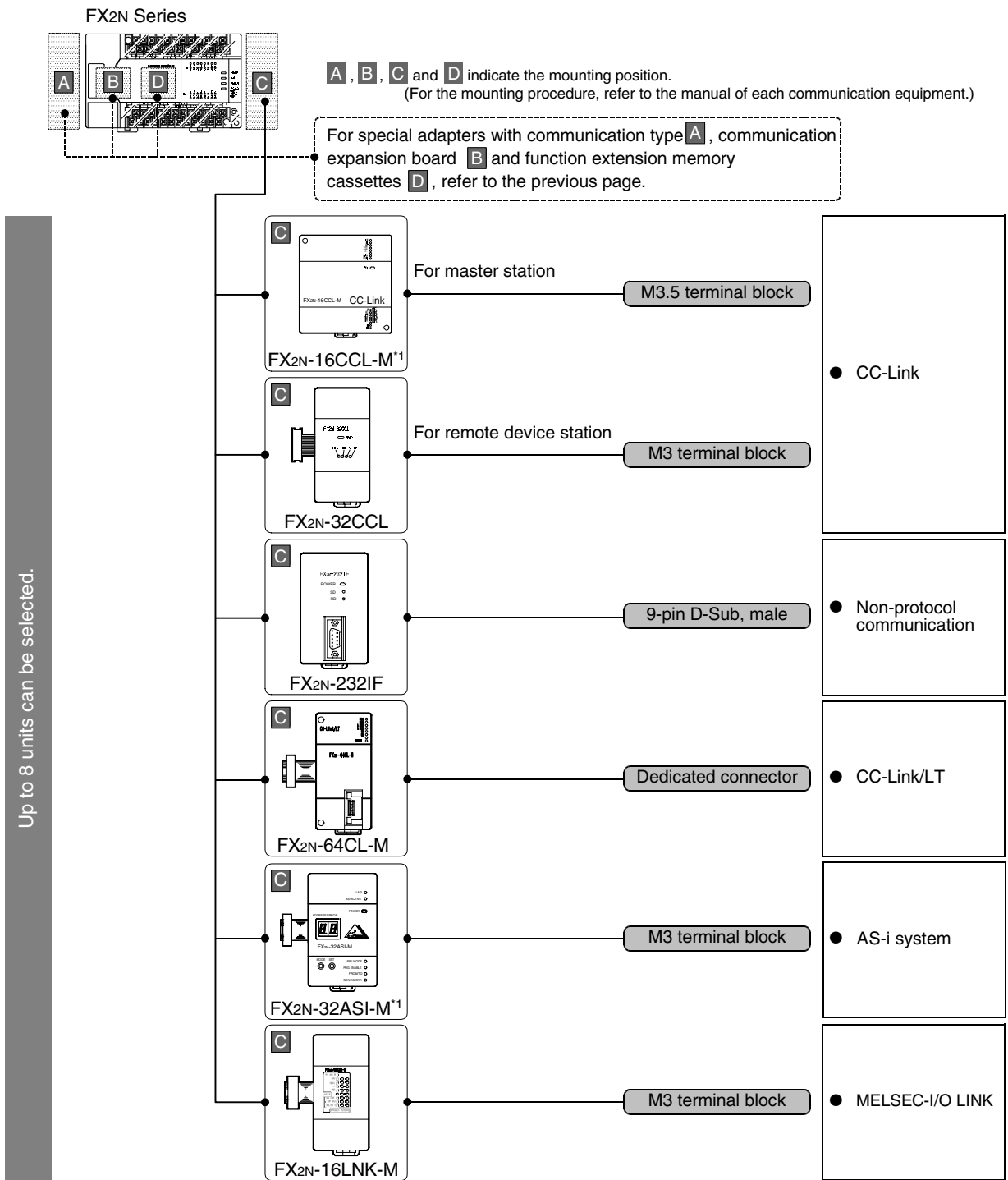

*1. The FX2N-16CCL-M and FX2N-32ASI-M cannot be used at the same time.

Limitation in the number of connectable units

Connected special function units/blocks operate using the 24V DC or 5V DC power supply of the PLC. Accordingly, when the total current consumption is larger than the current capacity of the PLC, the number of connectable units must be reduced.

→ For details, refer to the manual of each FX PLC.

A	Common Items
B	N:N Network
C	Parallel Link
D	Computer Link
E	Inverter Communication
F	Non-Protocol Communication (RS/RS2 Instruction)
G	Non-Protocol Communication (FX2N-232IF)
H	Programming Communication
I	Remote Maintenance

2.3.7 For FX2NC Series

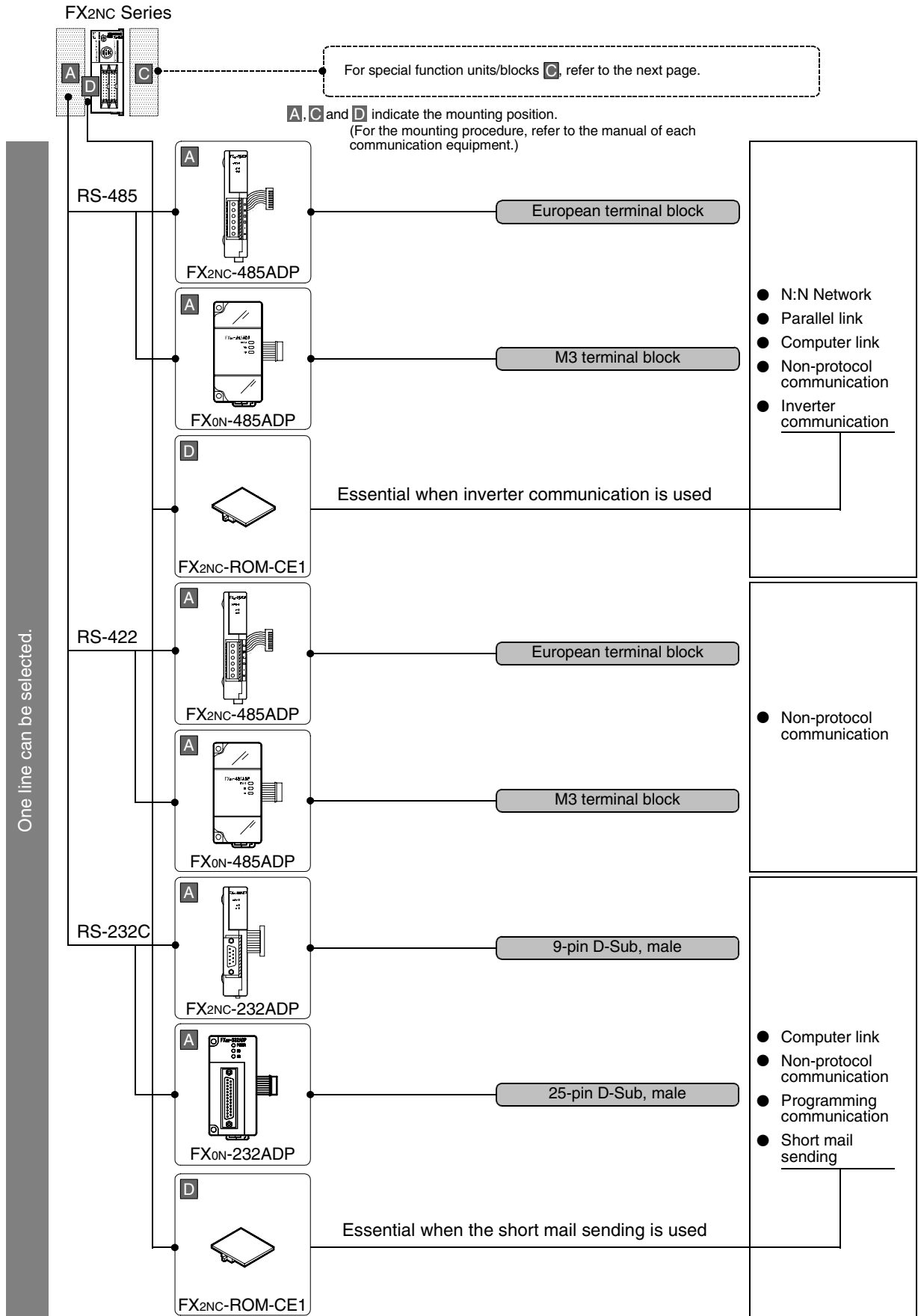

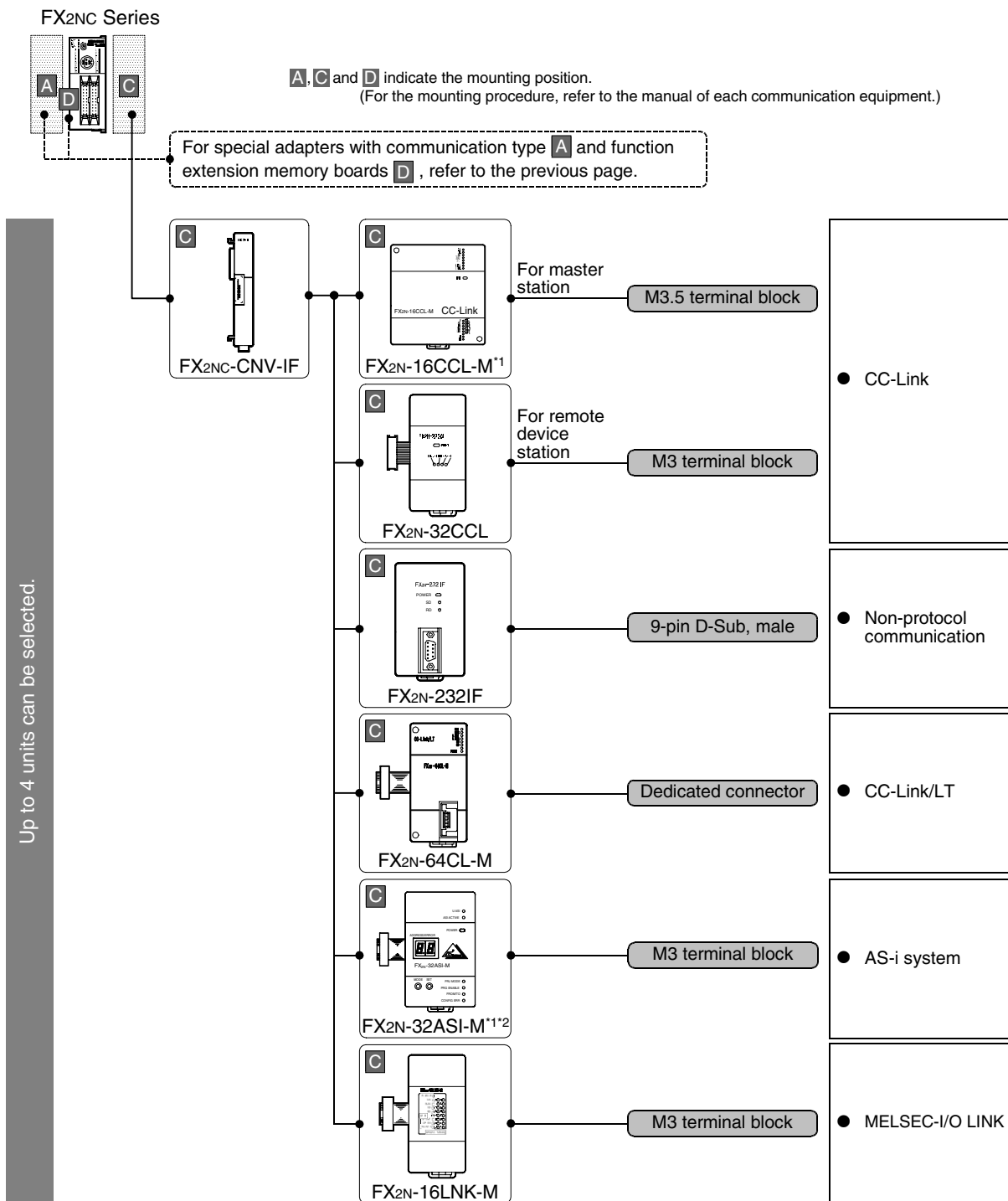

- *1. The FX2N-16CCL-M and FX2N-32ASI-M cannot be used at the same time.
- *2. The FX2NC-□MT-D/UL and FX2NC-□M□-DSS(-T-DS) are not supported.

Limitation in the number of connectable units

Connected special function units/blocks operate using the 24V DC or 5V DC power supply of the PLC. Accordingly, when the total current consumption is larger than the current capacity of the PLC, the number of connectable units must be reduced.

→ For details, refer to the manual of each FX PLC.

A	Common Items
B	N:N Network
C	Parallel Link
D	Computer Link
E	Inverter Communication
F	Non-Protocol Communication (RS/RS2 Instruction)
G	Non-Protocol Communication (FX2N-232IF)
H	Programming Communication
I	Remote Maintenance

2.3.8 For Fx3U Series

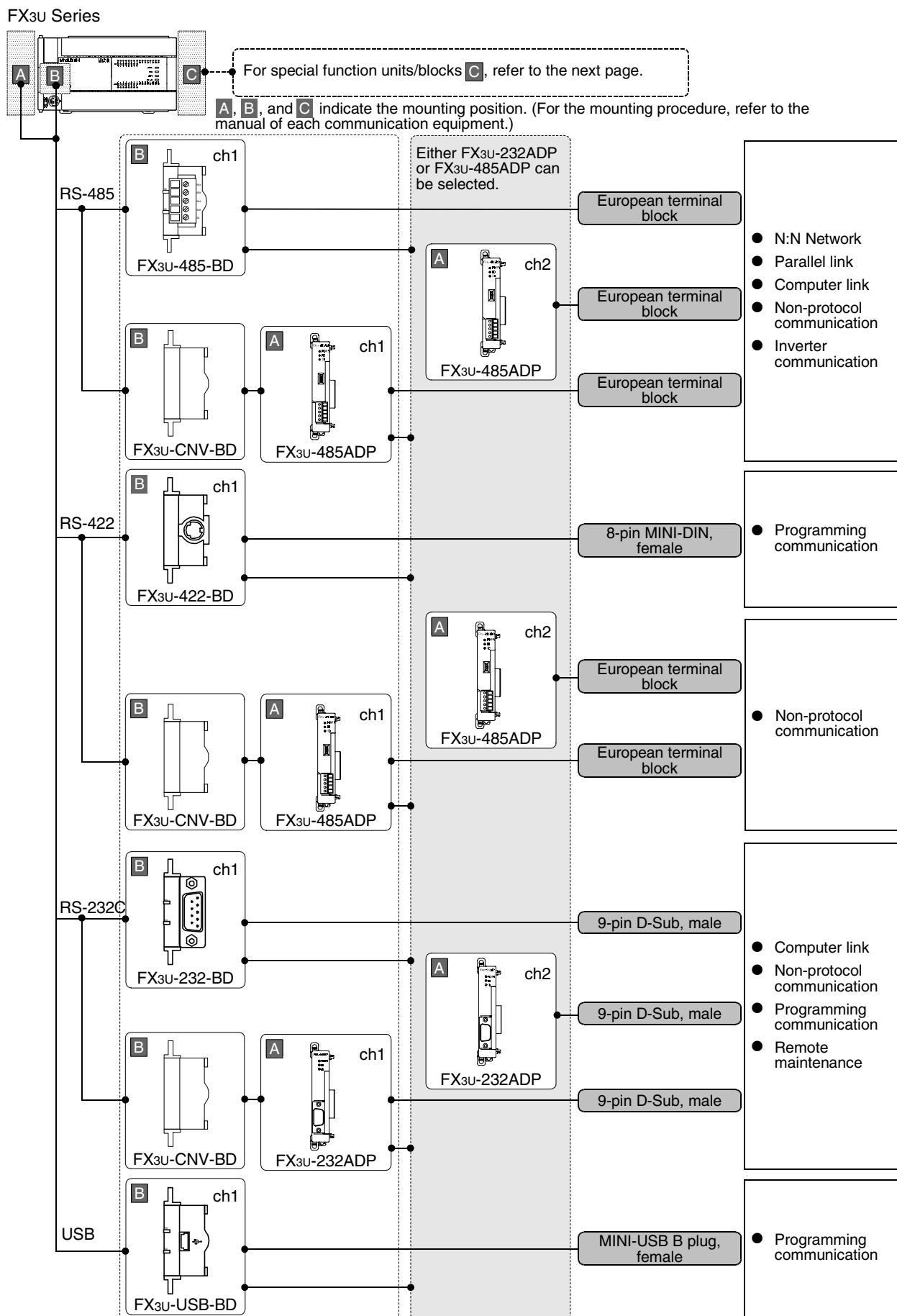

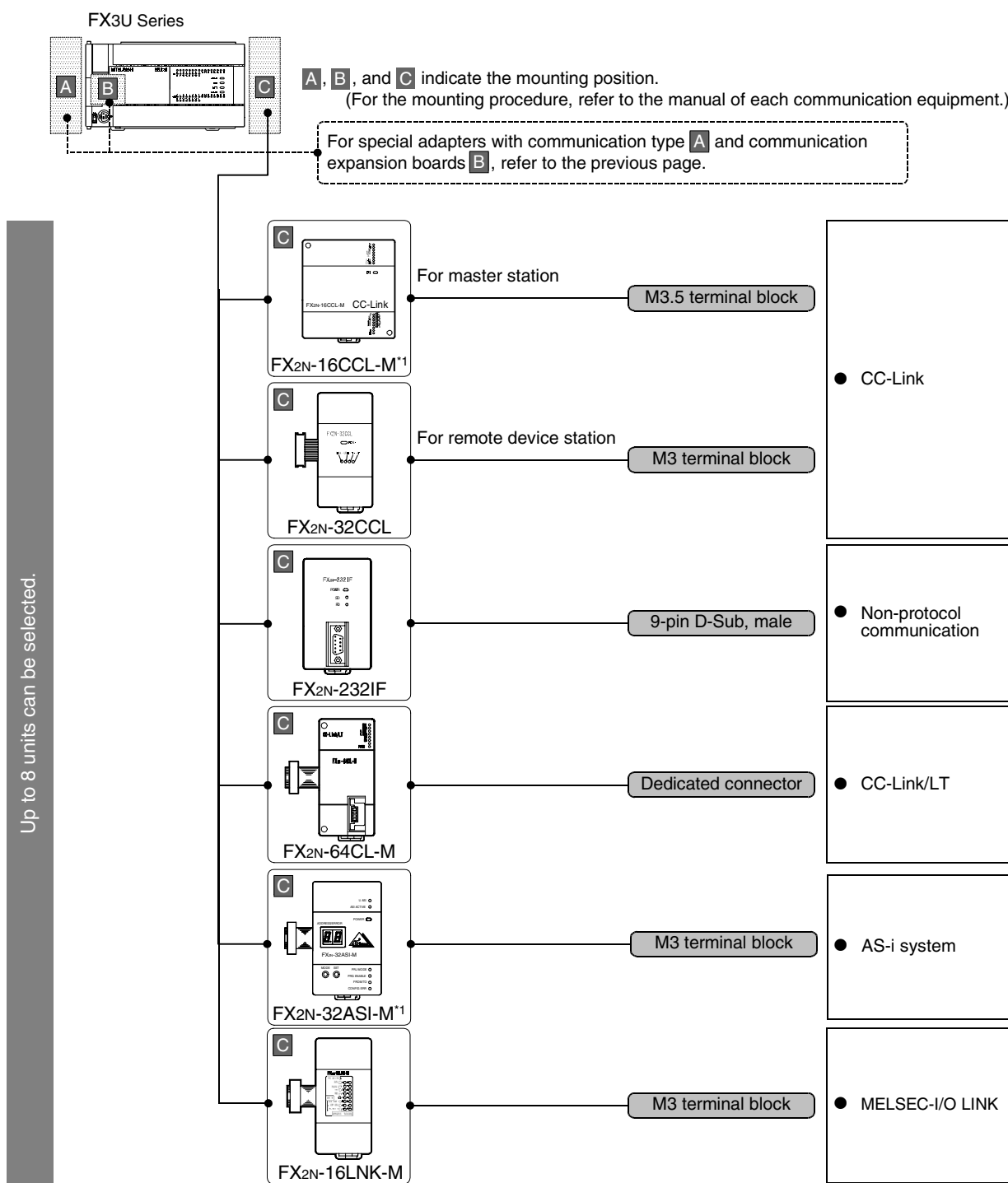

*1. The FX2N-16CCL-M and FX2N-32ASI-M cannot be used at the same time.

Limitation in the number of connectable units

Connected special function units/blocks operate using the 24V DC or 5V DC power supply of the PLC. Accordingly, when the total current consumption is larger than the current capacity of the PLC, the number of connectable units must be reduced.

→ For details, refer to the manual of each FX PLC.

A	Common Items
B	N:N Network
C	Parallel Link
D	Computer Link
E	Inverter Communication
F	Non-Protocol Communication (RS/RS2 Instruction)
G	Non-Protocol Communication (FX2N-232IF)
H	Programming Communication
I	Remote Maintenance

2.3.9 For FX3uc Series

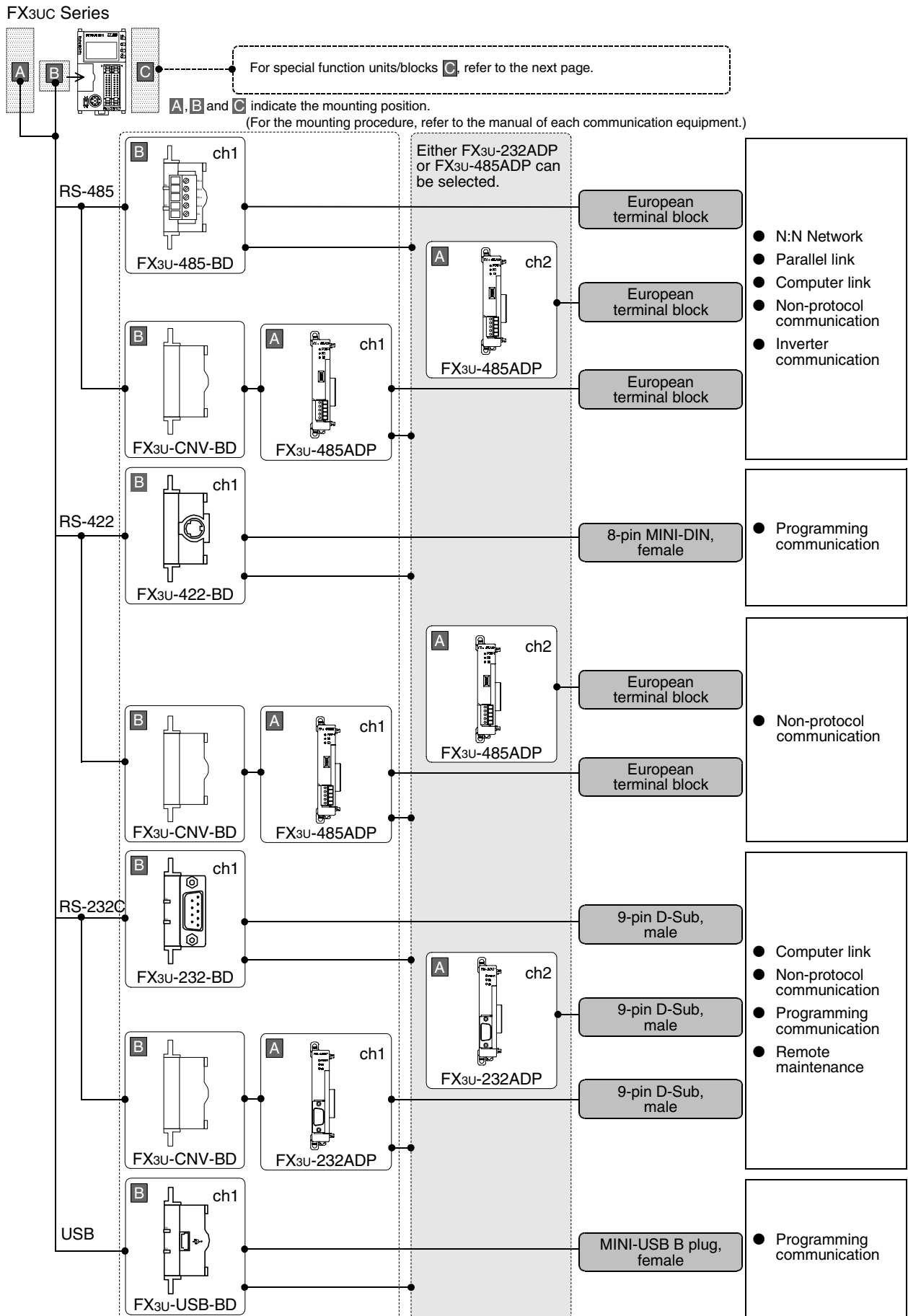

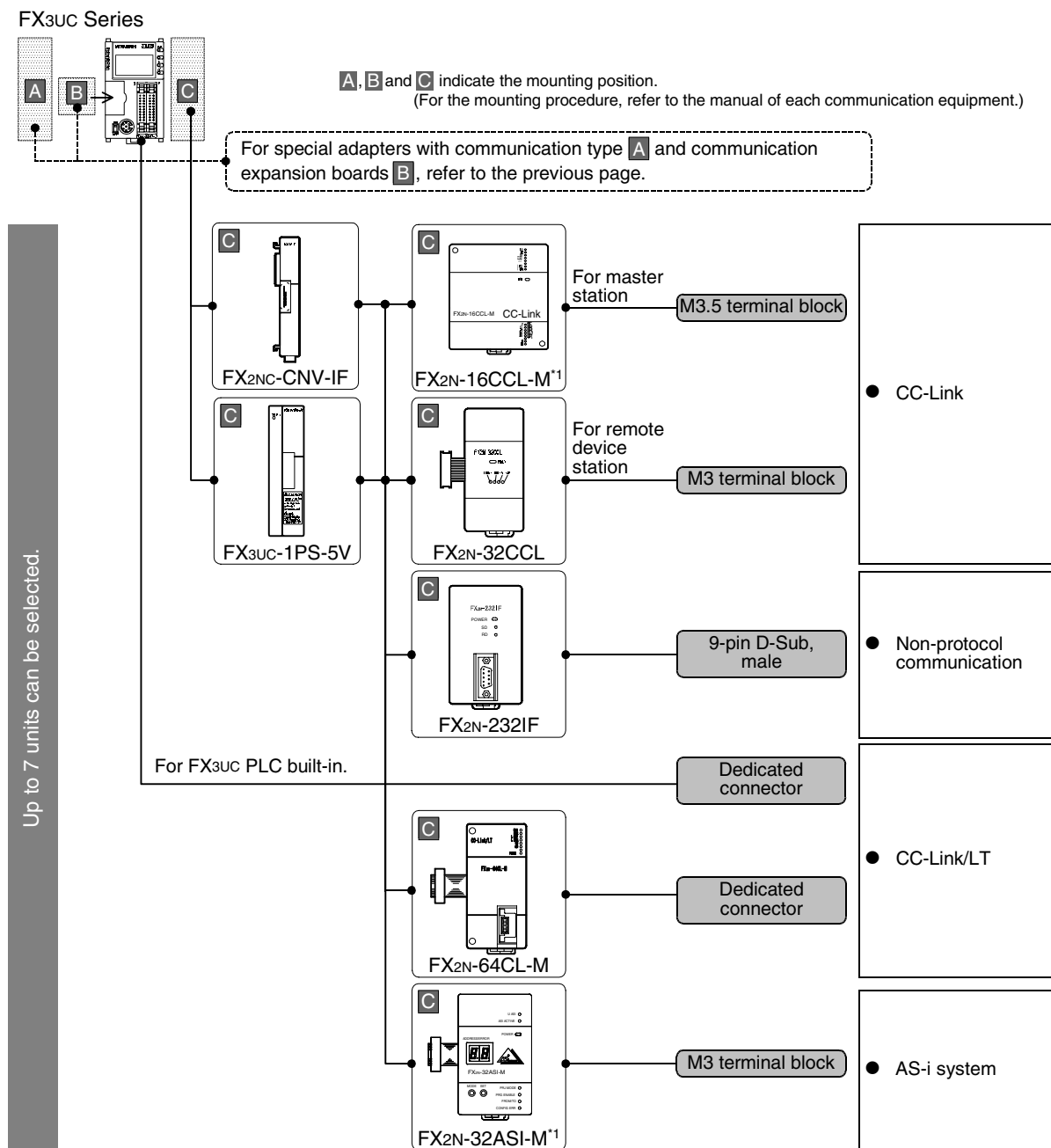

*1. The FX2N-16CCL-M and FX2N-32ASI-M cannot be used at the same time.

Limitation in the number of connectable units

Connected special function units/blocks operate using the 24V DC or 5V DC power supply of the PLC. Accordingly, when the total current consumption is larger than the current capacity of the PLC, it is necessary to add the power block FX3UC-1PS-5V.

→ For details, refer to the manual of each FX PLC.

A	Common Items
B	N:N Network
C	Parallel Link
D	Computer Link
E	Inverter Communication
F	Non-Protocol Communication (RS/RS2 Instruction)
G	Non-Protocol Communication (FX2N-232IF)
H	Programming Communication
I	Remote Maintenance

2.3.10 For FX2(FX) and FX2c Series (reference)

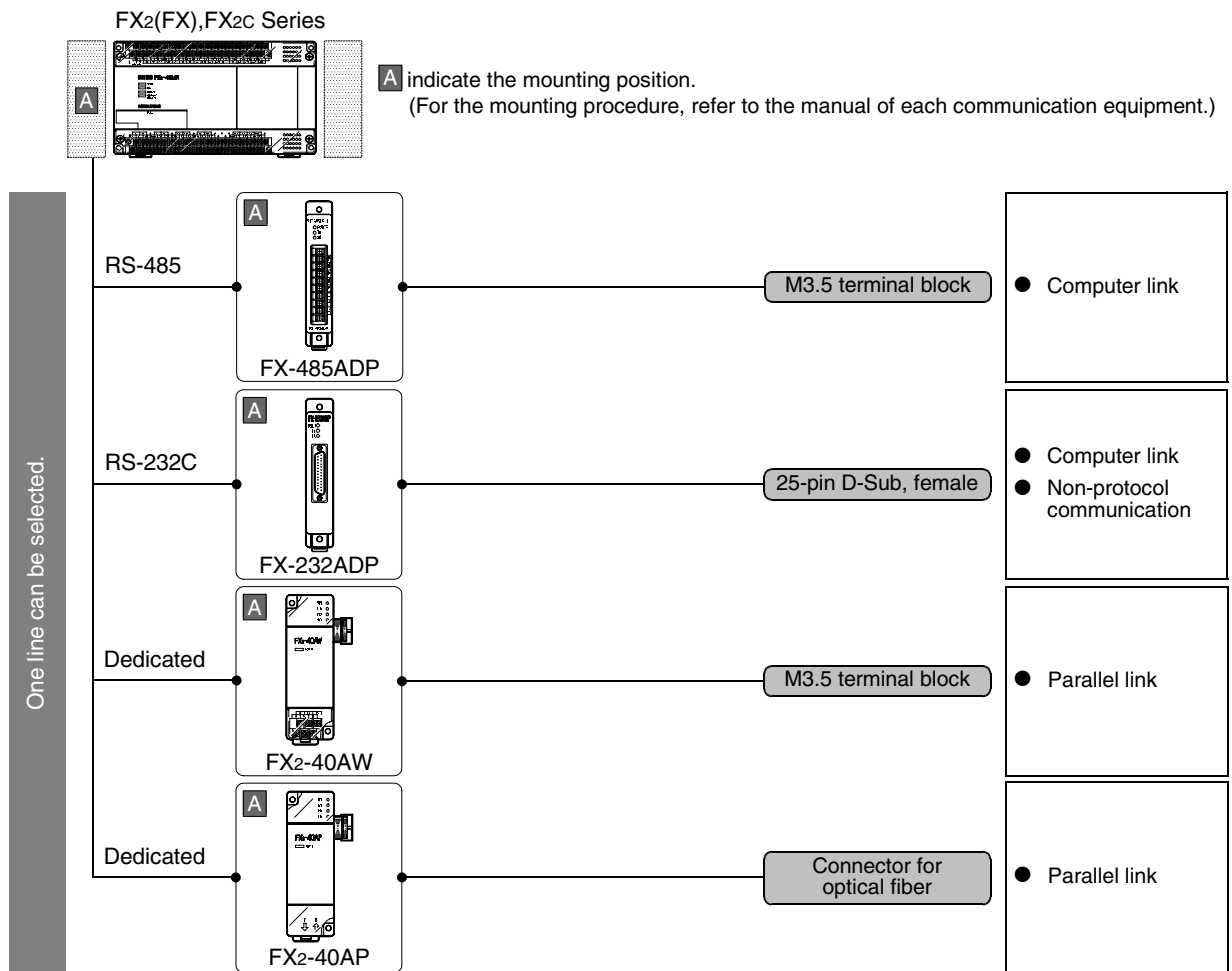

3. Outline of Communication Setting in FX Series

This chapter describes which communication parameters can be changed for each communication medium and provides methods on how to change them.

3.1 Setting Method

The following two communication setting methods are available for FX PLCs. Either method can be used, but the method using parameters is recommended.

1. Setting methods

- 1) Specify the setting using parameters in the sequence programming software
Register the setting in parameters, transfer it to the PLC and turn the PLC's power OFF and then ON.
(This method is not available in FX2(FX), FX2C, and FX0N PLCs.)
- 2) Directly specify the setting in a sequence program
Prepare a sequence program which sets the communication format, station number and timeout determination time, and then transfer the program to the PLC.

Caution

Regardless of the above chosen method, a PLC operates in the same way. If both methods are selected, priority is given to the method using parameters.

2. Communication setting method availability in each FX PLC

FX Series	FX2(FX),FX2C	FX0N	FX1S	FX1N,FX1NC	FX2N,FX2NC	FX3U,FX3UC
Parameter method	—	—	✓	✓	✓	✓
Program method	✓	✓	✓	✓	✓	✓

3. Setting flow

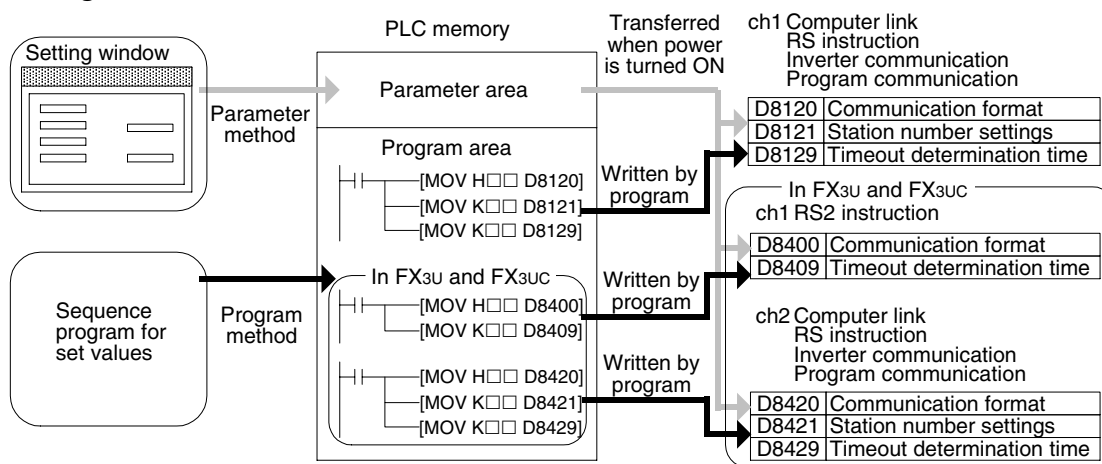

When both methods are selected at the same time, priority is given to the contents set in the parameter method.

4. Timing at which the setting becomes valid

- 1) Specifying the setting using parameters in the sequence programming software
When the plc power is turned ON, the contents of the parameters are automatically transferred to the PLC.
As soon as the parameters are transferred to the PLC, the setting becomes valid.
- 2) Directly specifying the setting in a sequence program
The PLC mode is set from STOP to RUN, the required data is written, and the PLC's power is turned OFF and then ON.
As soon as the plc power is turned ON, the setting becomes valid.

A	Common Items
B	N:N Network
C	Parallel Link
D	Computer Link
E	Inverter Communication
F	Non-Protocol Communication (RS/RS2 Instruction)
G	Non-Protocol Communication (FX2N-232IF)
H	Programming Communication
I	Remote Maintenance

3.2 Communication Setting in Parameter Method (GX Developer)

Communication settings may be changed by the parameter method with GX Developer and FXGP/WIN for Windows. This section describes how to change parameters with GX Developer.

3.2.1 Operating procedure

With GX Developer open, follow the steps in this section for activating the serial communication setting method.

1 Opening the parameter setting window

Double-click [Parameter] - [PLC parameter] from the project tree.

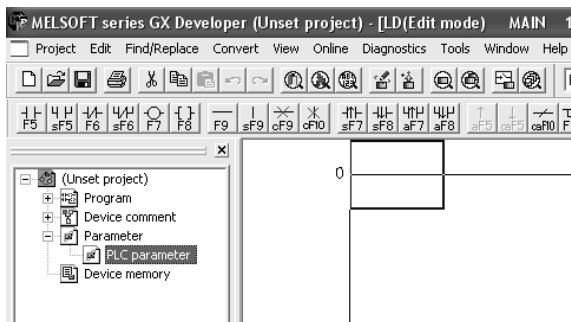

If the project tree is not displayed, select [View] - [Project data list] from the tool menu (to display a check mark on the left side).

2 Setting the serial communication (parameters)

Click the [PLC system(2)] tab on the dialog box.

- When using the programming communication, parallel link, N:N Network or remote maintenance, do not put a check mark next to the check box "Operate communication setting".
- When using computer link, inverter communication or non-protocol communication (RS/RS2 instruction) function, put a check mark next to the check box "Operate communication setting", and then set each item.

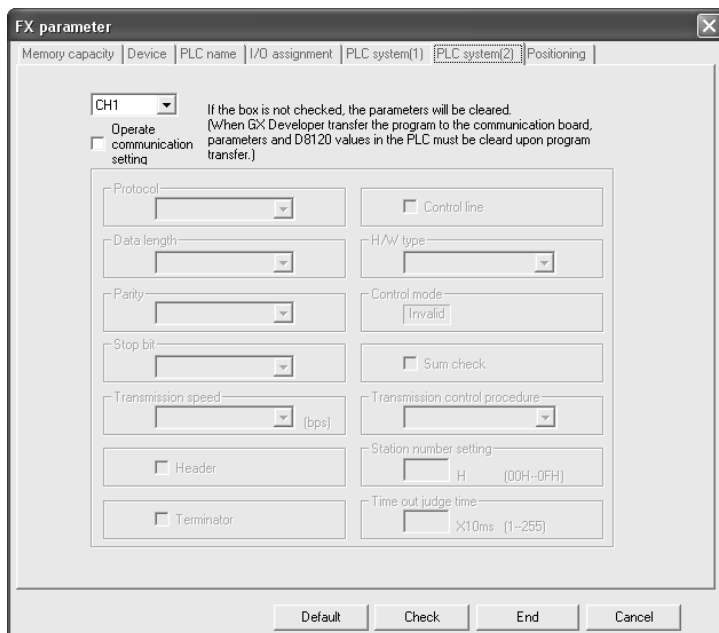

3 Writing parameters to the PLC

Select [Online] - [Write to PLC] from the tool menu, put a check mark next to "Parameter", and then click [Execute].

3.2.2 Correspondence between parameter setting and each communication network

The table below shows the communication types and set items which can be set using parameters:

Set item	Contents											Remarks				
		CC-Link network	N:N Network	Parallel link	Computer link	Inverter communication	Non-protocol communication (RS/RS2 instruction)	Non-protocol communication (FX2N-232IF)	Short mail sending	Internet mail sending	CC-Link/LT network		AS-i system	Programming communication	Remote maintenance	
Protocol	Non-protocol communication	This communication is not executed in this setting.	This communication is not executed in this setting.	This communication is not executed in this setting.	—	✓	✓	This communication is not executed in this setting.								
	Dedicated protocol				✓	—	—	This communication is not executed in this setting.								
Data length	7-bit				✓	✓	✓	—	—	This communication is not executed in this setting.						
	8-bit				✓	✓	✓	—	—	This communication is not executed in this setting.						
Parity	None				✓	✓	✓	—	—	This communication is not executed in this setting.						
	Odd				✓	✓	✓	—	—	This communication is not executed in this setting.						
	Even				✓	✓	✓	—	—	This communication is not executed in this setting.						
Stop bit	1-bit				✓	✓	✓	—	—	This communication is not executed in this setting.						
	2-bit				✓	✓	✓	—	—	This communication is not executed in this setting.						
Transmission speed (bps)	19200				✓	✓	✓	—	—	This communication is not executed in this setting.						
	9600				✓	✓	✓	—	—	This communication is not executed in this setting.						
	4800				✓	✓	✓	—	—	This communication is not executed in this setting.						
	2400				✓	—	—	—	—	This communication is not executed in this setting.						
	1200				✓	—	—	—	—	This communication is not executed in this setting.						
	600				✓	—	—	—	—	This communication is not executed in this setting.						
	300				✓	—	—	—	—	This communication is not executed in this setting.						
Header	Invalid/valid															
Terminator	Invalid/valid															
Control cable	Invalid/valid															
Hardware type	Regular/RS-232C															
	RS-485	✓	✓	✓	—	—	This communication is not executed in this setting.									
Control mode	Invalid											Not selectable				
Sum check	Invalid/valid															
Transmission control procedure	Format 1															
	Format 4	✓	—	—	—	—	This communication is not executed in this setting.									
Station number settings	00 to 0F															
Timeout determination time	1 to 255															
Reference page		—	B	C	D	E	F	G	—	—	—	—	H	I		

A	Common Items
B	N:N Network
C	Parallel Link
D	Computer Link
E	Inverter Communication
F	Non-Protocol Communication (RS/RS2 Instruction)
G	Non-Protocol Communication (FX2N-232IF)
H	Programming Communication
I	Remote Maintenance

3.3 Communication Setting in Parameter Method (FXGP/WIN)

Communication settings may be changed by the parameter method with GX Developer and FXGP/WIN for Windows. This section describes how to change parameters with FXGP/WIN. The ch 2 cannot be set using FXGP/WIN.

3.3.1 Operating procedure

This subsection explains the serial communication setting method. Suppose that FXGP/WIN is already started up.

1 Executing serial communication (parameter) setting

Select [Option] - [Serial setting (parameter)] from the tool menu. The following dialog appears according to absence/presence of parameter settings.

1. When there are no parameter settings

There is no communication setting. When using the programming communication, parallel link, N:N Network or remote maintenance, click the [No] button. When using computer link, inverter communication, or non-protocol communication (RS instruction) function, click the [Yes] button.

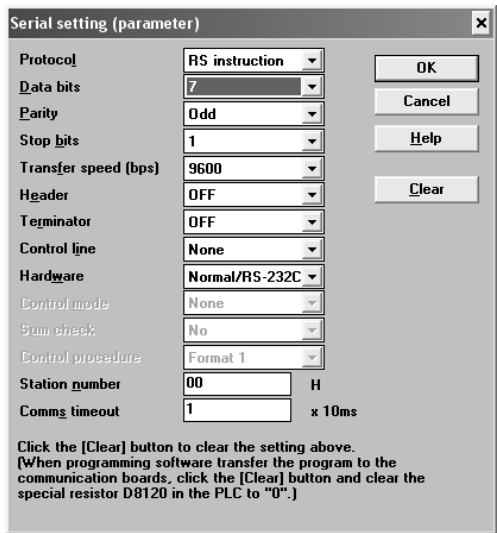
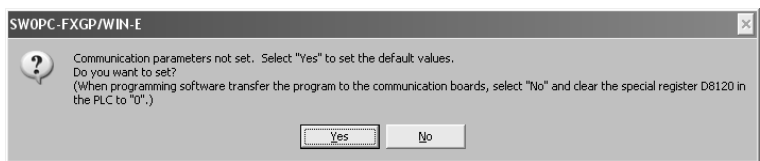

2. When there are already parameter settings

There is communication setting. Confirm the setting contents.
When using the programming communication, parallel link, N:N Network or remote maintenance, click the [Clear] button.

Serial setting (parameter)

Protocol	RS instruction	OK
Data bits	7	Cancel
Parity	Odd	Help
Stop bits	1	Clear
Transfer speed (bps)	9600	
Header	OFF	
Terminator	OFF	
Control line	None	
Hardware	Normal/RS-232C	
Control mode	None	
Sum check	No	
Control procedure	Format 1	
Station number	00 H	
Comms timeout	1 x 10ms	

Click the [Clear] button to clear the setting above.
(When programming software transfer the program to the communication boards, click the [Clear] button and clear the special resistor D8120 in the PLC to "0".)

A	Common Items
B	N:N Network
C	Parallel Link
D	Computer Link
E	Inverter Communication
F	Non-Protocol Communication (RS/RS2 Instruction)
G	Non-Protocol Communication (FX2N-232IF)
H	Programming Communication
I	Remote Maintenance

3.3.2 Correspondence between parameter setting and each communication type

The table below shows the communication types and items which can be set using parameters:

Set item	Contents	CC-Link network	N:N Network	Parallel link	Computer link	Inverter communication	Non-protocol communication (RS instruction)	Non-protocol communication (FX2N-232IF)	Short mail sending	Internet mail sending	CC-Link/LT network	AS-i system	Programming communication	Remote maintenance	Remarks
		This communication is not executed in this setting.		This communication is not executed in this setting.		This communication is not executed in this setting.		This communication is not executed in this setting.		This communication is not executed in this setting.		This communication is not executed in this setting.		This communication is not executed in this setting.	
Protocol	Non-protocol communication				—	✓	✓			✓					
	Dedicated protocol				✓	—	—			—					
Data length	7-bit				✓	✓	✓			—					
	8-bit				✓	✓	✓			✓					
Parity	None				✓	✓	✓			✓					
	Odd				✓	✓	✓			—					
	Even				✓	✓	✓			—					
Stop bit	1-bit				✓	✓	✓			✓					
	2-bit				✓	✓	✓			—					
Baud rate (bps)	19200				✓	✓	✓			—					
	9600				✓	✓	✓			✓					
	4800				✓	✓	✓			—					
	2400				✓	—	✓			—					
	1200				✓	—	✓			—					
	600				✓	—	✓			—					
Header	Invalid/valid				—	—	✓			—					
Terminator	Invalid/valid				—	—	✓			✓					
Control cable	Invalid/valid				—	—	✓			—					
Hardware type	Regular/RS-232C				✓	—	✓			✓					
	RS-485				✓	✓	✓			—					
Control mode	Invalid				—	—	—			—				Not selectable	
Sum check	Invalid/valid				✓	—	—			—					
Transmission control procedure	Format 1				✓	—	—			—					
	Format 4				✓	—	—			—					
Station number settings	00 to 0F				✓	—	—			—					
Timeout determination time	1 to 255				✓	—	✓			—					
Reference page		—	B	C	D	E	F	G	—	—	—	—	H	I	

3.4 Extension of Ports (FX3U, FX3UC)

In FX3U, FX3UC PLCs, up to two channels of communication ports can be connected to the main unit. When a communication expansion board and communication special adapter are used, the board is handled as the ch 1 and the adapter is handled as the ch 2. When connecting two communication special adapters using the FX3U-CNV-BD, the one nearer the main unit is handled as the ch 1 and the other farther from the main unit is handled as the ch 2.

1. For FX3U PLC

- When using a communication expansion board and a communication special adapter together
- When using two communication special adapters

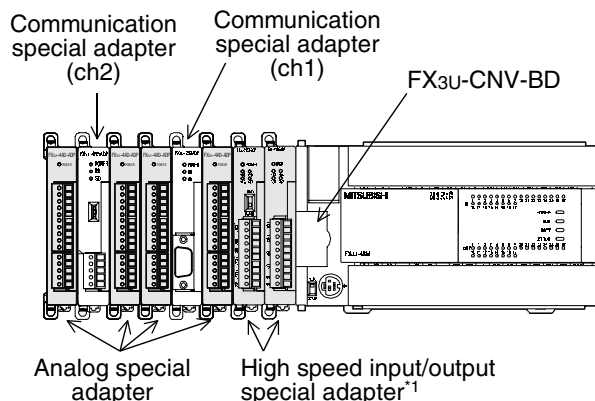
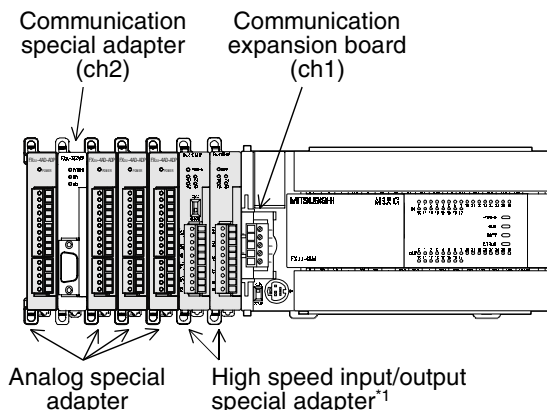

*1. When using high speed special input/output adapters, make sure to connect them first to the PLC main unit before connecting communication special adapters and analog special adapters.

2. For FX3UC PLC

- When using a communication expansion board and a communication special adapter together
- When using two communication special adapters

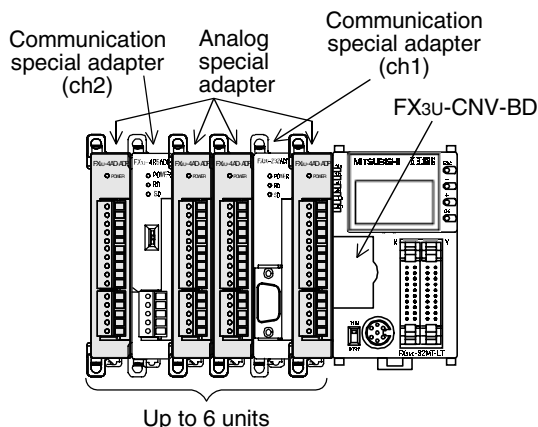
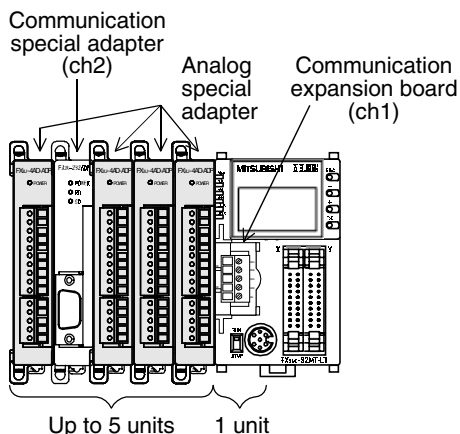

A	Common Items
B	N:N Network
C	Parallel Link
D	Computer Link
E	Inverter Communication
F	Non-Protocol Communication (RS/RS2 Instruction)
G	Non-Protocol Communication (FX2N-232IF)
H	Programming Communication
I	Remote Maintenance

3.4.1 Limitation when ch1 and ch2 are used at same time

When using ch1 and ch2 at the same time, available communication type combinations are limited. For details, refer to the table below.

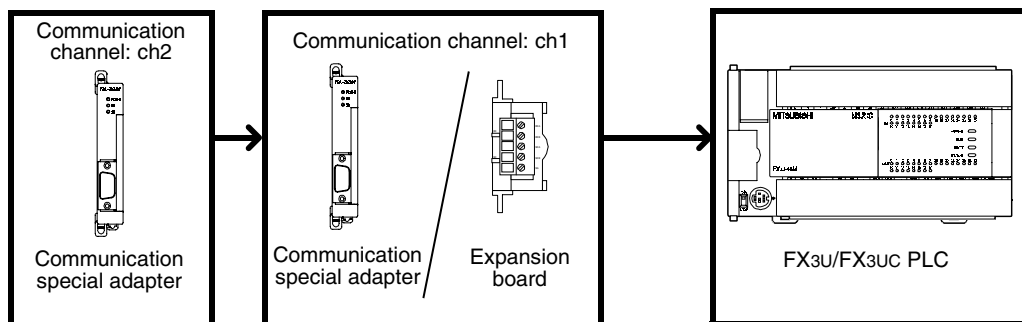

✓: Applicable, -: Not applicable

		Communication setting in ch1							
		N:N Network	Parallel link	Computer link	Inverter communication	Non-protocol communication (RS instruction)	Non-protocol communication (RS2 instruction)	Programming communication	Remote maintenance
Communication setting in ch2	N:N Network	-	- (Example 1)	✓ (Example 2)	✓	✓	✓	✓	✓
	Parallel link	-	-	✓	✓	✓	✓	✓	✓
	Computer link	✓	✓	✓	✓	✓	✓	✓	✓
	Inverter communication	✓	✓	✓	✓	✓	✓	✓	✓
	Non-protocol communication (RS instruction) ¹	-	-	-	-	-	-	-	-
	Non-protocol communication (RS2 instruction)	✓	✓	✓	✓	✓	✓	✓	✓
	Programming communication	✓	✓	✓	✓	✓	✓	✓	✓
	Remote maintenance ²	✓	✓	✓	✓	✓	✓	✓	-

- *1. Ch2 cannot be set for non-protocol communication (RS instruction).
- *2. When using remote maintenance on ch2, use the GX Developer Ver. 8.18U or later.

Example 1:
When "parallel link" is set on ch1, the "N:N Network" cannot be set on ch2.
Example 2:
When "computer link" is set on ch1, the "N:N Network" can be set on ch2.

4. Introduction of Manuals (Type, Reading Method and Acquisition Method)

This chapter explains manuals related to PLC main units and manuals for each communication type.

4.1 Rank and Use Method of This Manual

When communication equipment are connected, an FX PLC can offer various communication options.

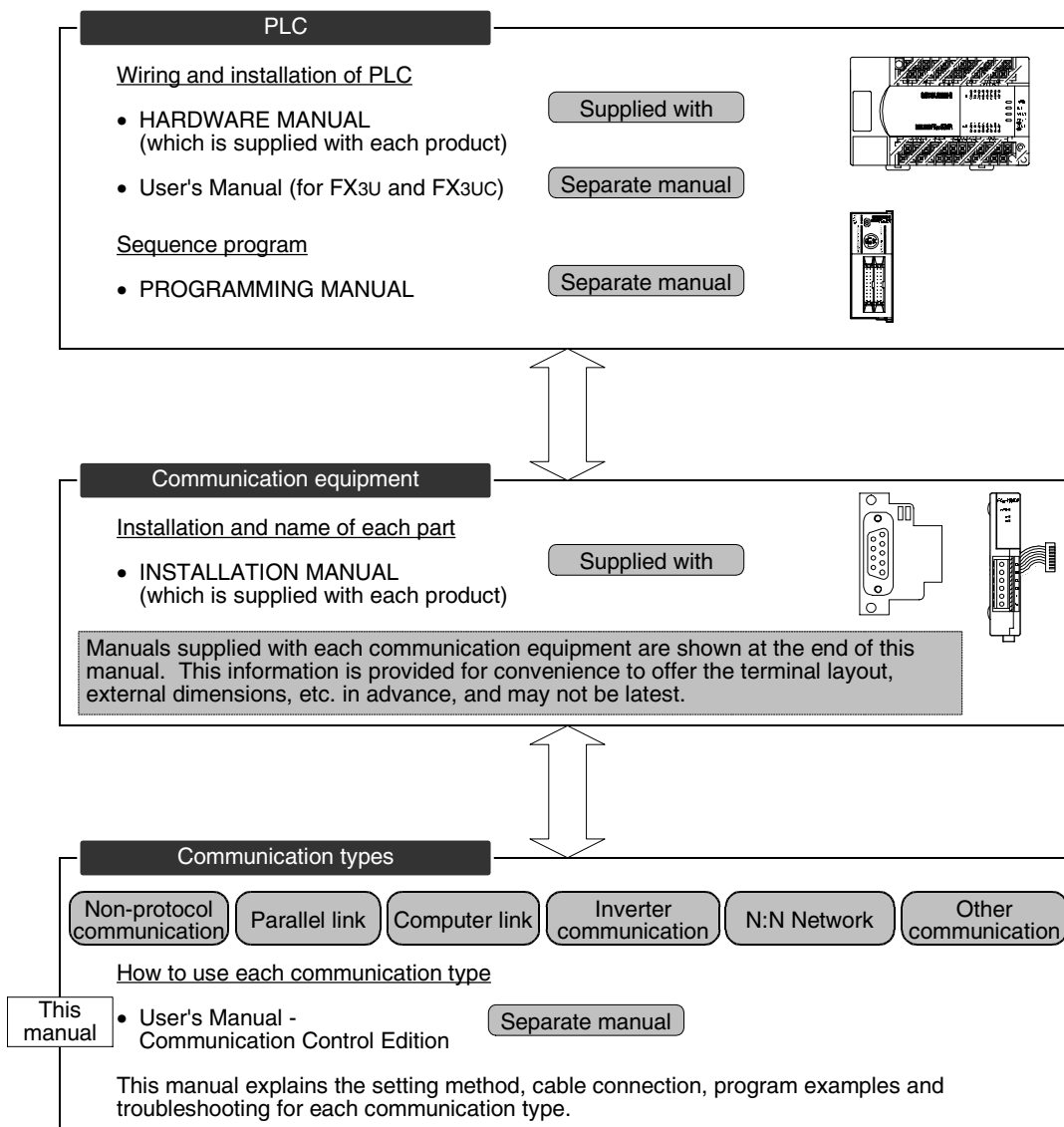

A	Common Items
B	N:N Network
C	Parallel Link
D	Computer Link
E	Inverter Communication
F	Non-Protocol Communication (RS/RS2 Instruction)
G	Non-Protocol Communication (FX2N-232IF)
H	Programming Communication
I	Remote Maintenance

4.2 Introduction of Related Manuals

This section shows major manuals required to use the communication types.

Manuals for PLC main units and manuals for communication equipment are classified separately.

"Separate manual" shown in the "Included/separate manual" column indicates that the manual is sent separately. "Included" indicates that the manual is included with each product.

4.2.1 Manual for communication types in FX PLCs

Manual name	Manual number	Included/separate document	Contents
FX Series			
FX Series User's Manual - Data Communication Edition	JY997D16901	Separate manual (this manual)	Describes the contents of communication types supported by FX Series PLCs.

4.2.2 Manuals related to FX PLCs

For instructions used in sequence programs, refer to the PROGRAMMING MANUAL.

For the hardware such as wiring of the PLC, refer to the HANDY MANUAL or USERS MANUAL.

Manual name	Manual number	Included/separate document	Contents
FX3U Series			
FX3U Series Hardware Manual	JY997D18801	Included	Describes the contents of the FX3U PLC main unit hardware including the specifications, wiring and installation.
FX3U Series User's Manual - Hardware Edition	JY997D16501	Separate manual	Describes the contents of the FX3U PLC main unit and extension unit hardware including specifications, wiring and installation.
FX3U/FX3UC Programming Manual - Basic & Applied Instruction Edition	JY997D16601	Separate manual	Explains basic instructions and applied instructions available in the FX3U/3UC PLC.
FX2NC Series			
FX2NC HARDWARE MANUAL	JY992D76401	Included	Describes the contents of the FX2NC PLC hardware including the specifications, wiring and installation.
FX1S,FX1N,FX2N,FX1NC,FX2NC PROGRAMMING MANUAL	JY992D88101	Separate manual	Explains instructions applicable in the FX1S, FX1N, FX2N, FX1NC and FX2NC PLCs.
FX1NC Series*1			
FX1NC HANDY MANUAL	JY992D92101	Included	Describes the contents of the FX1NC PLC hardware including the specifications, wiring and installation.
FX1S,FX1N,FX2N,FX1NC,FX2NC PROGRAMMING MANUAL	JY992D88101	Separate manual	Explains instructions available in the FX1S, FX1N, FX2N, FX1NC and FX2NC PLCs.
FX2N Series			
FX2N HARDWARE MANUAL	JY992D66301	Included	Describes the contents of the FX2N PLC hardware including the specifications, wiring and installation.
FX1S,FX1N,FX2N,FX1NC,FX2NC PROGRAMMING MANUAL	JY992D88101	Separate manual	Explains instructions available in the FX1S, FX1N, FX2N, FX1NC and FX2NC PLCs.

*1. FX1NC Series PLC Manual is available only in Japanese.

Manual name	Manual number	Included/separate document	Contents
FX1N Series			
FX1N HARDWARE MANUAL	JY992D89301	Included	Describes the contents of the FX1N PLC hardware including the specifications, wiring and installation.
FX1S,FX1N,FX2N,FX1NC,FX2NC PROGRAMMING MANUAL	JY992D88101	Separate manual	Explains instructions available in the FX1S, FX1N, FX2N, FX1NC and FX2NC PLCs.
FX1S Series			
FX1S HARDWARE MANUAL	JY992D83901	Included	Describes the contents of the FX1S PLC hardware including the specifications, wiring and installation.
FX1S,FX1N,FX2N,FX1NC,FX2NC PROGRAMMING MANUAL	JY992D88101	Separate manual	Explains instructions available in the FX1S, FX1N, FX2N, FX1NC and FX2NC PLCs.
FX0N Series			
FX0N HARDWARE MANUAL	JY992D47501	Included	Describes the contents of the FX0N PLC hardware including the specifications, wiring and installation.
FX0,FX0S,FX0N,FX1,FX2(FX),FX2C PROGRAMMING MANUAL	JY992D48301	Separate manual	Explains instructions available in the FX0, FX0S, FX0N, FX1, FX2(FX), FX2C PLCs.
FX2(FX) Series			
FX2(FX) HARDWARE MANUAL	JY992D47401	Included	Describes the contents of the FX2(FX) PLC hardware including the specifications, wiring and installation.
FX0,FX0S,FX0N,FX1,FX2(FX),FX2C PROGRAMMING MANUAL	JY992D48301	Separate manual	Explains instructions available in the FX0, FX0S, FX0N, FX1, FX2(FX), FX2C PLCs.
FX2c Series*2			
FX2c HANDY MANUAL	JY992D59001	Included	Describes the contents of the FX2c PLC hardware including the specifications, wiring and installation.
FX0,FX0S,FX0N,FX1,FX2(FX),FX2C PROGRAMMING MANUAL	JY992D48301	Separate manual	Explains instructions available in the FX0, FX0S, FX0N, FX1, FX2(FX), FX2C PLCs.

*2. FX2c Series PLC Manual is available only in Japanese.

4.2.3 Communication equipment (option)

The table below shows manuals of communication equipment operating in accordance with RS-232C, RS-422 and RS-485.

Manual name	Manual number	Included/separate document	Contents
For communication in accordance with RS-232C			
FX3U-232-BD INSTALLATION MANUAL	JY997D12901	Included	Describes the contents of the communication expansion board in accordance with RS-232C FX3U-232-BD hardware including the specifications and installation.
FX3U-232ADP INSTALLATION MANUAL	JY997D13701	Included	Describes the contents of the communication special adapter in accordance with RS-232C FX3U-232ADP hardware including the specifications and installation.
FX-232ADP USER'S GUIDE	JY992D48801	Included	Describes the contents of the communication special adapter in accordance with RS-232C FX-232ADP hardware including the specifications and installation.

A	Common Items
B	N:N Network
C	Parallel Link
D	Computer Link
E	Inverter Communication
F	Non-Protocol Communication (RS/RS2 Instruction)
G	Non-Protocol Communication (FX2N-232IF)
H	Programming Communication
I	Remote Maintenance

Manual name	Manual number	Included/separate document	Contents
FX0N-232ADP INSTALLATION MANUAL	JY992D51201	Included	Describes the contents of the communication special adapter in accordance with RS-232C FX0N-232ADP hardware including the specifications and installation.
FX2NC-232ADP INSTALLATION MANUAL	JY997D01101	Included	Describes the contents of the communication special adapter in accordance with RS-232C FX2NC-232ADP hardware including the specifications and installation.
FX2N-232-BD USER'S GUIDE	JY992D63201	Included	Describes the contents of the communication expansion board in accordance with RS-232C FX2N-232-BD hardware including the specifications and installation.
FX1N-232-BD USER'S GUIDE	JY992D84401	Included	Describes the contents of the communication expansion board in accordance with RS-232C FX1N-232-BD hardware including the specifications and installation.
FX2N-232IF HARDWARE MANUAL	JY992D73501	Included	Describes the contents of the communication special extension block in accordance with RS-232C FX2N-232IF hardware including the specifications and installation.
For communication in accordance with RS-422			
FX3U-422-BD INSTALLATION MANUAL	JY997D13101	Included	Describes the contents of the communication expansion board in accordance with RS-422 FX3U-422-BD hardware including the specifications and installation.
FX2N-422-BD USER'S GUIDE	JY992D66101	Included	Describes the contents of the communication expansion board in accordance with RS-422 FX2N-422-BD hardware including the specifications and installation.
FX1N-422-BD USER'S MANUAL	JY992D84101	Included	Describes the contents of the communication expansion board in accordance with RS-422 FX1N-422-BD hardware including the specifications and installation.
For communication in accordance with RS-485(422)			
FX3U-485-BD INSTALLATION MANUAL	JY997D13001	Included	Describes the contents of the communication special expansion board in accordance with RS-485 FX3U-485-BD hardware including the specifications and installation.
FX3U-485ADP INSTALLATION MANUAL	JY997D13801	Included	Describes the contents of the communication special adapter in accordance with RS-485 FX3U-485-ADP hardware including the specifications and installation.
FX0N-485ADP INSTALLATION MANUAL	JY992D53101	Included	Describes the contents of the communication special adapter in accordance with RS-485 FX0N-485-ADP hardware including the specifications and installation.
FX2NC-485ADP INSTALLATION MANUAL	JY997D01201	Included	Describes the contents of the communication special adapter in accordance with RS-485 FX2NC-485-ADP hardware including the specifications and installation.
FX2N-485-BD HARDWARE MANUAL	JY992D73401	Included	Describes the contents of the hardware communication expansion board in accordance with RS-485 FX2N-485-BD including the specifications and installation.

Manual name	Manual number	Included/separate document	Contents
FX1N-485-BD USER'S GUIDE	JY992D84201	Included	Describes the contents of the communication expansion board in accordance with RS-485 FX1N-485-BD hardware including the specifications and installation.
For communication in accordance with USB			
FX3U-USB-BD USER'S MANUAL	JY997D13501	Included	Describes the contents of the communication expansion board in accordance with USB FX3U-USB-BD hardware including the specifications and installation.

4.2.4 Related options for communication

The table below shows manuals of products required to use the above options in the system configuration.

Manual name	Manual number	Included/separate document	Contents
Connector conversion board			
FX3U-CNV-BD INSTALLATION MANUAL	JY997D13601	Included	Describes the contents of the special adapter connection board FX3U-CNV-BD hardware including the installation.
FX2N-CNV-BD	JY992D63601	Included	Describes the contents of the special adapter connection board FX2N-CNV-BD hardware including the installation.
FX1N-CNV-BD	JY992D84701	Included	Describes the contents of the special adapter connection board FX1N-CNV-BD hardware including the installation.
RS-485/RS-232C converter for computer link communication			
FX-485-PC-IF-SET HARDWARE MANUAL	JY992D81801	Included	Describes the contents of the interface unit FX-485-PC-IF-SET hardware including the specifications and installation.

A	Common Items
B	N:N Network
C	Parallel Link
D	Computer Link
E	Inverter Communication
F	Non-Protocol Communication (RS/RS2 Instruction)
G	Non-Protocol Communication (FX2N-232IF)
H	Programming Communication
I	Remote Maintenance

5. Abbreviations, Generic Names and Terms Used in This Manual

The table below shows abbreviations, generic names and terms used in this manual.

1. Programmable controllers

Abbreviation/ generic name	Name
Programmable controllers	
FX PLC or FX CPU	Generic name of FX0, FX0S, FX1S, FX0N, FX1N, FX1, FX2(FX), FX2C, FX2N, FX3U, FX1NC, FX2NC, and FX3UC Series PLCs
FX3U Series	Generic name of FX3U Series PLCs
FX3U PLC or main unit	Generic name of FX3U Series PLC main units
FX3UC Series	Generic name of FX3UC Series PLCs
FX3UC PLC or main unit	Generic name of FX3UC Series PLC main units Only Japanese manual is available for this product.
FX2N Series	Generic name of FX2N Series PLCs
FX2N PLC or main unit	Generic name of FX2N Series PLC main units
FX2NC Series	Generic name of FX2NC Series PLCs
FX2NC PLC or main unit	Generic name of FX2NC-□M□(-T), FX2NC-□MT-D/UL, and FX2NC-□M□-DSS(-T-DS) Series PLC main units
FX2NC-□M□(-T) PLC	FX2NC-16MR-T, FX2NC-16MT, FX2NC-32MT, FX2NC-64MT, and FX2NC-96MT
FX2NC-□MT-D/UL PLC	FX2NC-16MT-D/UL, FX2NC-32MT-D/UL, FX2NC-64MT-D/UL, and FX2NC-96MT-D/UL
FX2NC-□M□-DSS (-T-DS) PLC	FX2NC-16MR-T-DS, FX2NC-16MT-DSS, FX2NC-32MT-DSS, FX2NC-64MT-DSS, and FX2NC-96MT-DSS
FX1N Series	Generic name of FX1N Series PLCs
FX1N PLC or main unit	Generic name of FX1N Series PLC main units
FX1NC Series	Generic name of FX1NC Series PLCs
FX1NC PLC or main unit	Generic name of FX1NC Series PLC main units Only Japanese manual is available for this product.
FX1S Series	Generic name of FX1S Series PLCs
FX1S PLC or main unit	Generic name of FX1S Series PLC main units
FX2(FX) Series	Generic name of FX2(FX) Series PLCs
FX2(FX) PLC or main unit	Generic name of FX2(FX) Series PLC main units
FX2C Series	Generic name of FX2C Series PLCs
FX2C PLC or main unit	Generic name of FX2C Series PLC main units
FX1 Series	Generic name of FX1 Series PLCs
FX1 PLC or main unit	Generic name of FX1 Series PLC main units Only Japanese manual is available for this product.
FX0N Series	Generic name of FX0N Series PLCs
FX0N PLC or main unit	Generic name of FX0N Series PLC main units
FX0 Series	Generic name of FX0 Series PLCs
FX0 PLC or main unit	Generic name of FX0 Series PLC main units

Abbreviation/ generic name	Name
FX0s Series	Generic name of FX0s Series PLCs
FX0s PLC or main unit	Generic name of FX0s Series PLC main units
Q PLC	Generic name of CPU units QCPU (Q mode) and QCPU (A mode)
QCPU (Q mode)	Generic name of CPU units Q00JCPU, Q00CPU, Q01CPU, Q02CPU, Q02HCPU, Q06HCPU, Q12HCPU, and Q25HCPU
QCPU (A mode)	Generic name of CPU units Q02CPU-A, Q02HCPU-A, and Q06HCPU-A
QnA PLC	Generic name of CPU units QnACPU (large type) and QnACPU (small type)
QnACPU (large type)	Generic name of CPU units Q2ACPU, Q2ACPU-S1, Q3ACPU, Q4ACPU, and Q4ARCPU
QnACPU (small type)	Generic name of CPU units Q2ASCPU, Q2ASCPU-S1, Q2ASHCPU, and Q2ASHCPU-S1
A PLC	Generic name of CPU units ACPU (large type), ACPU (small type), and A1FXCPU
ACPU (large type)	Generic name of CPU units AnUCPU, AnACPU, AnNCPU, and A0J2(H)CPU
ACPU (small type)	Generic name of CPU units A2US(H)CPU, AnS(H)CPU, and A1SJ(H)CPU
A1FXCPU	Generic name of CPU unit A1FXCPU

2. Expansion boards and special adapters

Abbreviation/ generic name	Name
Expansion board	
Expansion board	Generic name of communication expansion boards and special adapter connection boards
Communication expansion board or communication board	Generic name of communication expansion boards
232BD	FX3U-232-BD, FX2N-232-BD, and FX1N-232-BD
422BD	FX3U-422-BD, FX2N-422-BD, and FX1N-422-BD
485BD	FX3U-485-BD, FX2N-485-BD, and FX1N-485-BD
USBBD	FX3U-USB-BD
Special adapter connection board or connector conversion board	Generic name of CNVBD
CNVBD	FX3U-CNV-BD, FX2N-CNV-BD, and FX1N-CNV-BD
Special adapters	
Special adapter	Generic name of high speed input/output special adapters, communication special adapters and analog special adapters
High speed input/output special adapter	Generic name of high speed input/output special adapters
2HSY-ADP	FX3U-2HSY-ADP
4HSX-ADP	FX3U-4HSX-ADP
Communication special adapter or communication adapter	Generic name of communication special adapters
232ADP	FX3U-232ADP, FX2NC-232ADP, FX0N-232ADP, and FX-232ADP
485ADP	FX3U-485ADP, FX2NC-485ADP, FX0N-485ADP, and FX-485ADP

A

Common Items

B

N:N Network

C

Parallel Link

D

Computer Link

E

Inverter Communication

F

Non-Protocol Communication (RS/RSS2 Instruction)

G

Non-Protocol Communication (FX2N-232IF)

H

Programming Communication

I

Remote Maintenance

3. Extension equipment

Abbreviation/ generic name	Name
Extension equipment	
Extension equipment	Generic name of extension blocks, powered extension units, special function blocks and special function units
Special function unit	Generic name of special function units
Special function block	Generic name of special function block
232IF	Generic name of FX2N-232IF

4. Networks

Abbreviation/ generic name	Name
Open field networks CC-Link and CC-Link/LT	
CC-Link equipment	Generic name of CC-Link master station and CC-Link remote device stations
CC-Link master (station)	Generic name of CC-Link master station (having following model name) FX2N-16CCL-M
CC-Link remote station	Generic name of remote I/O stations and remote device stations
CC-Link/LT equipment	Generic name of CC-Link/LT master station, CC-Link/LT remote I/O stations, power supply adapters, and dedicated power supplies
CC-Link/LT master	Generic name of built-in type CC-Link/LT master and (additional) CC-Link/LT master
Built-in type CC-Link/LT master	Generic name of built-in type CC-Link/LT master built in FX3UC-32MT-LT
(Additional) CC-Link/LT master	Generic name of CC-Link/LT master station (having following model name) FX2N-64CL-M
Power supply adapter	Generic name of units connected to supply power to CC-Link/LT system
Dedicated power supply	Generic name of power supplies connected to supply power to CC-Link/LT system
AS-i system	
AS-i master	Generic name of AS-i system master station (having following model name) FX2N-32ASI-M
MESEC I/O LINK	
MELSEC I/O LINK master	Generic name of MELSEC I/O LINK master station (having following model name) FX2N-16LNK-M

5. Peripheral equipment

Abbreviation/ generic name	Name
Peripheral equipment	
Peripheral equipment	Generic name of programming software, handy programming panels, and display units
Programming tools	
Programming tool	Generic name of programming software and handy programming panels
Programming software	Generic name of programming software
GX Developer	Generic name of programming software packages SW□D5C-GPPW-J and SW□D5C-GPPW-E
FXGP/WIN	Generic name of programming software packages FX-PCS/WIN and FX-PCS/WIN-E
Handy programming panel (HPP)	Generic name of FX-20P(-E) and FX-10P(-E)
RS-232C/RS-422 converter	FX-232AW, FX-232AWC, and FX-232AWC-H
RS-232C/RS-485 converter	FX-485PC-IF-SET and FX-485PC-IF

Abbreviation/ generic name	Name
Display units	
GOT1000 Series	Generic name of GT15 and GT11
GOT-900 Series	Generic name of GOT-A900 and GOT-F900 Series
GOT-A900 Series	Generic name of GOT-A900 Series
GOT-F900 Series	Generic name of GOT-F900 Series
Internet mail sending tools	
Mail sending units	Generic name of FX-232DOPA mail sending units
FX-232DOPA	FX-232DOPA mail sending main units Only Japanese manual is available for this product. These products can only be used in Japan.

6. Others

Abbreviation/ generic name	Name
Inverters	
FREQROL inverter	Generic name of Mitsubishi F700, A700, V500, F500, A500, E500, and S500 Series inverters
Communication	
Communication equipment	Generic name of communication equipment operating in accordance with RS-232C, communication equipment operating in accordance with RS-422, communication equipment operating in accordance with RS-485, and communication equipment operating in accordance with USB
Communication equipment operating in accordance with RS-232C	Generic name of 232BD, 232ADP, and 232IF
Communication equipment operating in accordance with RS-422	Generic name of 422BD
Communication equipment operating in accordance with RS-485	Generic name of 485BD and 485ADP
Communication equipment operating in accordance with USB	Generic name of USB BD
Personal computers	
Personal computer	Personal computers supporting Windows in which GX Developer or FXGP/WIN is installed
Windows	Generic name of Windows95, Windows98, WindowsMe, WindowsNT4.0, Windows2000, and WindowsXP
Windows95	Abbreviation of Microsoft® Windows® 95
Windows98	Abbreviation of Microsoft® Windows® 98
WindowsMe	Abbreviation of Microsoft® Windows® Millennium Edition
WindowsNT4.0	Abbreviation of Microsoft® WindowsNT® 4.0 Workstation
Windows2000	Abbreviation of Microsoft® Windows® 2000 Professional
WindowsXP	Abbreviation of Microsoft® Windows® XP Professional and Microsoft® Windows® XP Home Edition

A	Common Items
B	N:N Network
C	Parallel Link
D	Computer Link
E	Inverter Communication
F	Non-Protocol Communication (RS/RS2 Instruction)
G	Non-Protocol Communication (FX2N-232IF)
H	Programming Communication
I	Remote Maintenance

MEMO

FX Series Programmable Controllers

User's Manual [N:N Network]

Foreword

This manual explains the "N:N Network" provided in MELSEC-F FX Series Programmable Controllers and should be read and understood before attempting to install or use the unit. Store this manual in a safe place so that you can take it out and read it whenever necessary. Always forward it to the end user.

This manual confers no industrial property rights or any rights of any other kind, nor does it confer any patent licenses. Mitsubishi Electric Corporation cannot be held responsible for any problems involving industrial property rights which may occur as a result of using the contents noted in this manual.

© 2005 MITSUBISHI ELECTRIC CORPORATION

A

Common Items

B

N:N Network

C

Parallel Link

D

Computer Link

E

Inverter Communication

F

Non-Protocol Communication (RS/RS2 Instruction)

G

Non-Protocol Communication (FX2N-232IF)

H

Programming Communication

I

Remote Maintenance

1. Outline

This chapter explains the N:N Network.

1.1 Outline of System

The N:N Network allows connection of up to eight FX PLCs through communication in accordance with RS-485 to mutually link devices.

- 1) One of three patterns can be selected according to the number of devices to be linked (except FX1S and FX0N PLCs).
- 2) Data link is automatically updated among up to eight FX PLCs.
- 3) The available total extension distance is 500 m (1640' 5") maximum (when only the 485ADP is used in the configuration).

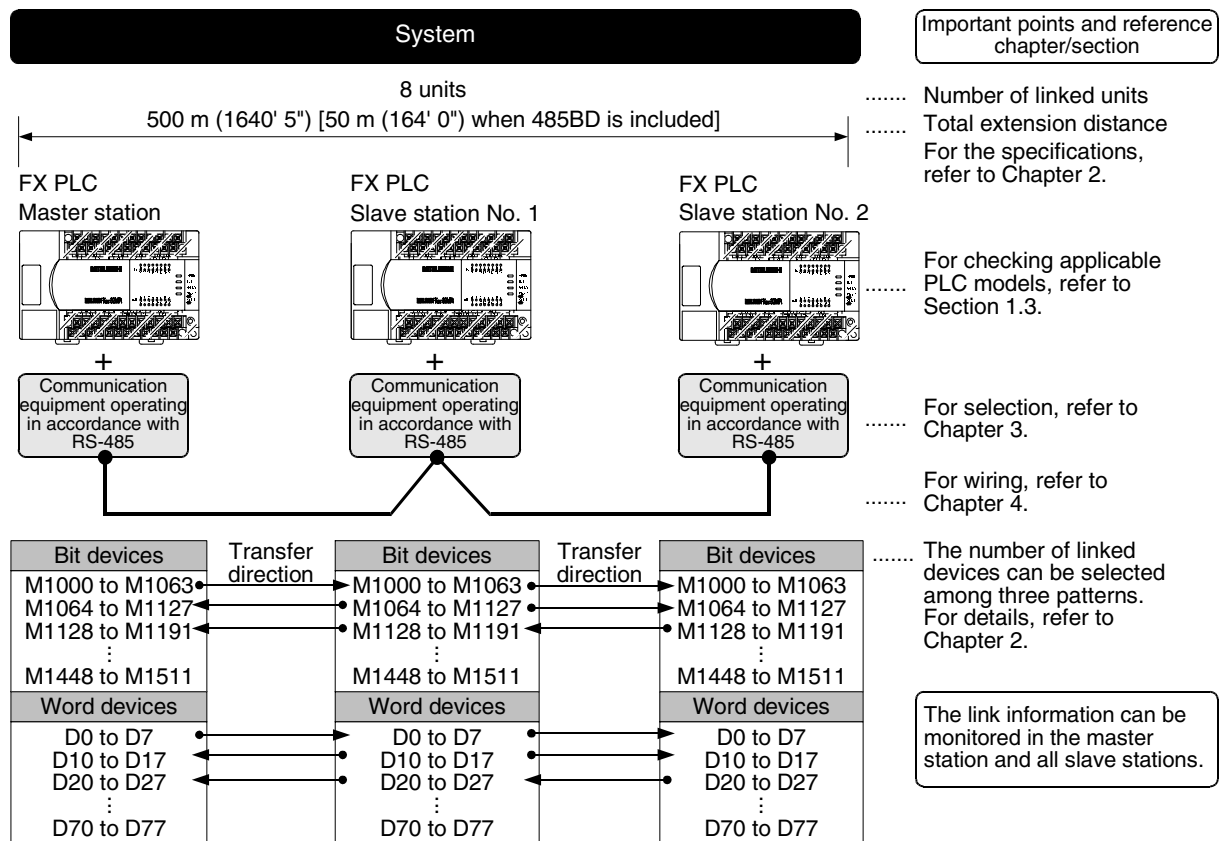

The above figure shows the maximum number of linked devices. There are differences in the specifications and limitation depending on the selected link pattern and FX Series.

A	Common Items
B	N:N Network
C	Parallel Link
D	Computer Link
E	Inverter Communication
F	Non-Protocol Communication (RS/RS2 Instruction)
G	Non-Protocol Communication (FX2N-232IF)
H	Programming Communication
I	Remote Maintenance

1.2 Major Procedures until Operation

The flow chart below shows the procedures for setting the N:N Network until data link:

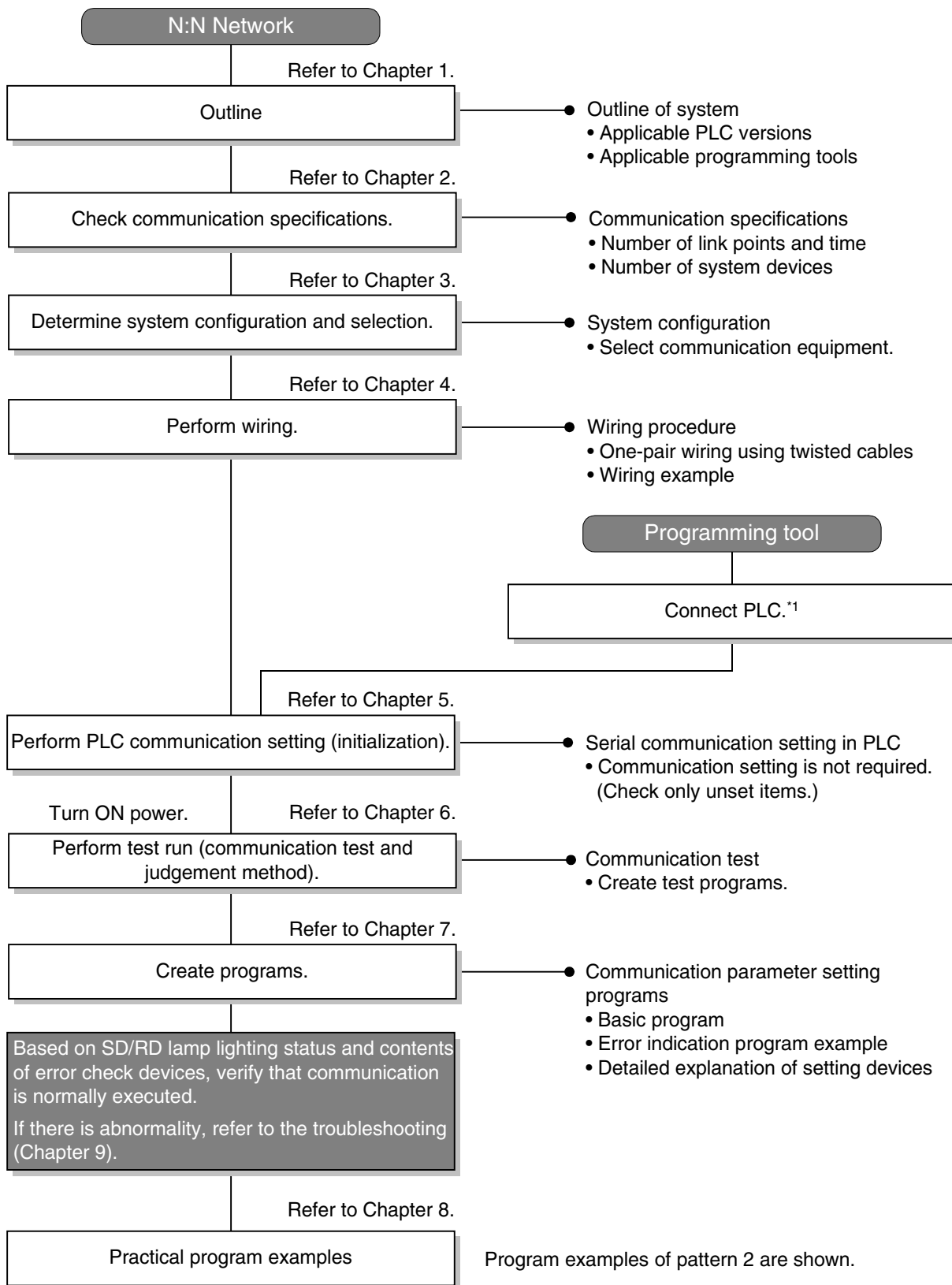

*1 For the method to connect a programming tool to a PLC, refer to the edition "Programming Communication" in this manual or the manual of each programming tool.
 For details on operating procedures, refer to the manual of each programming tool.

1.3 Communication Type Applicability in PLC

1.3.1 Applicable versions

The communication type is applicable in the following versions.

✓: Applicable (If applicable versions are limited, they are described inside ().) —: Not applicable

PLC	Applicability (applicable version)	Remarks
FX3UC Series	✓	
FX3U Series	✓	
FX2NC Series	✓	
FX2N Series	✓ (Ver. 2.00 or later)*1	
FX1NC Series	✓	
FX1N Series	✓	
FX1S Series	✓	The link device range is limited.
FX0N Series	✓ (Ver. 2.00 or later)*1	The link device range is limited.
FX0s Series	—	N:N Network option is not provided.
FX0 Series	—	N:N Network option is not provided.
FX2C Series	—	N:N Network option is not provided.
FX2(FX) Series	—	N:N Network option is not provided.
FX1 Series	—	N:N Network option is not provided.

*1. Applicable in products manufactured in October, 1997 and later (manufacturer's serial No.: 7X**** and later).

1. Version check

The D8001(decimal) special data register contains information for determining the PLC version.

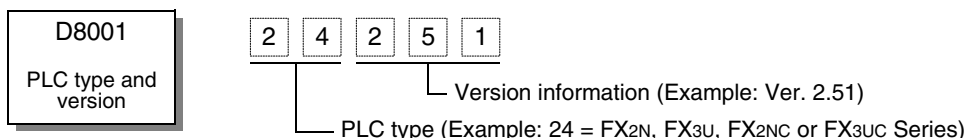

2. How to look at the manufacturer's serial number

The year and month of production of product can be seen from the Manufacturer's serial number "SERIAL" indicated on the label adhered to the right side of the product.

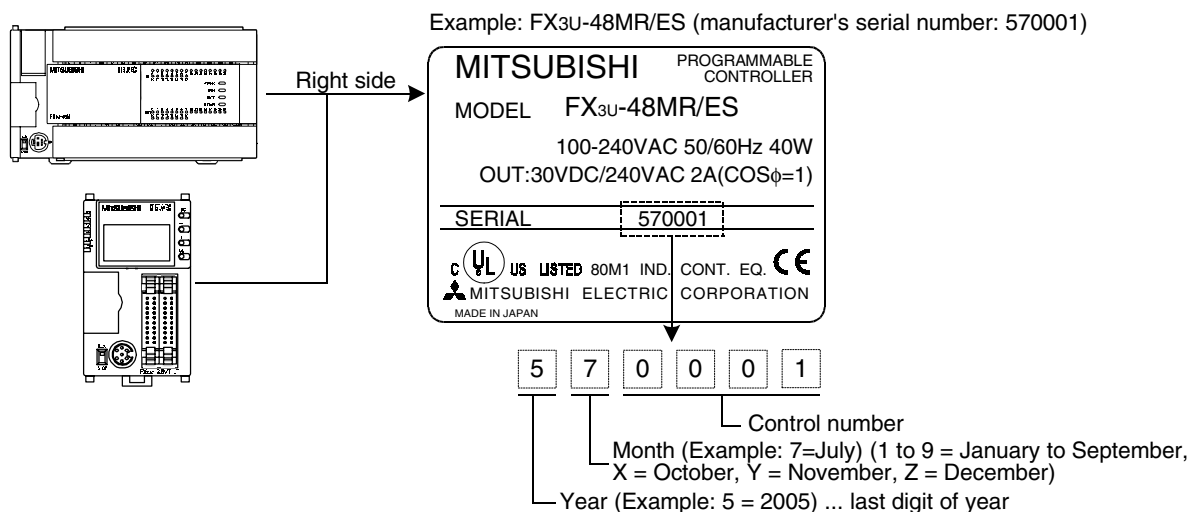

1.3.2 Products whose production was stopped

The table below shows series in which production of the main unit, communication equipment, etc. is stopped.

Use the description on system configuration, etc. in this manual for maintenance.

FX Series	Date when production was stopped	Remarks
FX0 Series	June 30, 2002	Maintenance is offered within 7 years from the end of production (until June 30, 2009).
FX2c Series		
FX2(FX) Series		
FX1 Series		

1.4 Programming Tool Applicability

1.4.1 For applicable versions

The programming tool is applicable in each FX Series from the following version:

1. Japanese versions

✓: Applicable (If applicable versions are limited, they are described inside ().) —: Not applicable

Model name (Media model name is shown below.)	Applicability (applicable version)	Remarks
FX3u and FX3uc PLCs		
GX Developer SW□D5C(F)-GPPW-J	✓ (Ver. SW8 P or later) Ver. 8.13P	Select the model "FX3UC".
FX2N and FX2NC PLCs		
GX Developer SW□D5C(F)-GPPW-J	✓ (Ver. SW2 A or later)	Select the model "FX2N/FX2NC".
FX-PCS/WIN SW0PC-FXGP/WIN	✓ (Ver. 2.00 or later)	
FX-PCS-KIT/98 SW1PC-FXGP/98(-3,-5)	✓ (Ver. 4.00 or later)	
FX-PCS/98-3 SW1PC-FXGP/98-3	✓ (Ver. 4.00 or later)	
FX-PCS-KIT/V-3 SW1-PC-FXGP/V3	✓ (Ver. 2.00 or later)	
FX-A7PHP-KIT SW1RX-GPPFX	✓ (Ver. 3.00 or later)	
FX-20P(-SET0) FX-20P-MFXC	✓ (Ver. 4.00 or later)	
FX-10P(-SET0)	✓ (Ver. 3.00 or later)	
GOT-F900 Series display units F940WGOT-TWD F940GOT-*WD F940GOT-*BD-H F940GOT-*BD-RH	✓ (Refer to right column.)	F940WGOT-TWD (Ver. 1.00 or later) F940GOT-LWD, F940GOT-SWD (Ver. 1.00 or later) F940GOT-LBD-H, F940GOT-SBD-H (Ver. 1.00 or later) F940GOT-LBD-RH, F940GOT-SBD-RH (Ver. 1.00 or later)

Model name (Media model name is shown below.)	Applicability (applicable version)	Remarks
FX1S, FX1N and FX1NC PLCs		
GX Developer SW□D5C(F)-GPPW-J	✓ (Ver. SW5 A or later)	Select the model "FX1S/FX1N".
FX-PCS/WIN SW0PC-FXGP/WIN	✓ (Ver. 4.00 or later)	
FX-PCS/98-3 SW1PC-FXGP/98-3	✓ (Ver. 5.00 or later)	
FX-20P(-SET0) FX-20P-MFXD	✓ (Ver. 5.00 or later)	
FX-10P(-SET0)	✓ (Ver. 4.00 or later)	
GOT-F900 Series display units F940WGOT-TWD F940GOT-*WD F940GOT-*BD-H F940GOT-*BD-RH	✓ (Refer to right column.)	F940WGOT-TWD (Ver. 1.00 or later) F940GOT-LWD, F940GOT-SWD (Ver. 1.00 or later) F940GOT-LBD-H, F940GOT-SBD-H (Ver. 1.00 or later) F940GOT-LBD-RH, F940GOT-SBD-RH (Ver. 1.00 or later)

2. English versions

✓: Applicable (If applicable versions are limited, they are described inside ().) —: Not applicable

Model name (Media model name is shown below.)	Applicability (applicable version)	Remarks
FX3U and FX3UC PLCs		
GX Developer SW□D5C(F)-GPPW-E	✓ (Ver. SW8 P or later) Ver.8.13P	Select the model "FX3UC".
FX2N and FX2NC PLCs		
GX Developer SW□D5C(F)-GPPW-E	✓ (Ver. SW2 A or later)	Select the model "FX2N/FX2NC".
FX-PCS/WIN-E SW0PC-FXGP/WIN-E	✓ (Ver. 1.00 or later)	
FX-20P-E(-SET0) FX-20P-MFXC-E	✓ (Ver. 3.00 or later)	
FX-10P-E	✓ (Ver. 3.00 or later)	
GOT-F900 Series display units F940WGOT-TWD-E F940GOT-*WD-E F940GOT-*BD-H-E F940GOT-*BD-RH-E	✓ (Refer to right column.)	F940WGOT-TWD-E (Ver. 1.00 or later) F940GOT-LWD-E, F940GOT-SWD-E (Ver. 1.00 or later) F940GOT-LBD-H-E, F940GOT-SBD-H-E (Ver. 1.00 or later) F940GOT-LBD-RH-E, F940GOT-SBD-RH-E (Ver. 1.00 or later)
FX1S, FX1N and FX1NC PLCs		
GX Developer SW□D5C(F)-GPPW-E	✓ (Ver. SW5 A or later)	Select the model "FX1S/FX1N".
FX-PCS/WIN-E SW0PC-FXGP/WIN-E	✓ (Ver. 3.00 or later)	
FX-20P-E(-SET0) FX-20P-MFXD-E	✓ (Ver. 4.00 or later)	
FX-10P-E	✓ (Ver. 4.00 or later)	
GOT-F900 Series display units F940WGOT-TWD-E F940GOT-*WD-E F940GOT-*BD-H-E F940GOT-*BD-RH-E	✓ (Refer to right column.)	F940WGOT-TWD-E (Ver. 1.00 or later) F940GOT-LWD-E, F940GOT-SWD-E (Ver. 1.00 or later) F940GOT-LBD-H-E, F940GOT-SBD-H-E (Ver. 1.00 or later) F940GOT-LBD-RH-E, F940GOT-SBD-RH-E (Ver. 1.00 or later)

1.4.2 For non-applicable versions (setting an alternative model)

Even software not applicable in a PLC can make programs when an alternative model is set. In this case, however, programming is enabled only in the ranges such as instructions and program size provided in the PLC selected as the alternative model.

Model to be programmed	Model to be set	Priority: High → Low			
		→		→	
FX3UC Series	FX3UC	→	FX2N	→	FX2(FX)
FX3U Series	FX3UC, FX3U	→	FX2N	→	FX2(FX)
FX2NC Series	FX2NC, FX2N	→	FX2(FX)		
FX2N Series	FX2N	→	FX2(FX)		
FX1NC Series	FX1NC, FX1N	→	FX2N	→	FX2(FX)
FX1N Series	FX1N	→	FX2N	→	FX2(FX)
FX1S Series	FX1S	→	FX2(FX)		
FX0N Series	FX0N	→	FX2(FX)		
FX0S Series	FX0S	→	FX2(FX)		
FX0 Series	FX0	→	FX2(FX)		
FX2C Series	FX2C, FX2(FX)	→	FX2(FX)		
FX2(FX) Series	FX2(FX)	→	FX2(FX)		
FX1 Series	FX1				

2. Specifications

This chapter explains the communication specifications and performance.

2.1 Communication Specifications (Reference)

Communication is executed in the (fixed) specifications shown in the table below. Any specification item such as baud rate cannot be changed.

Item	Specifications	Remarks
Number of connectable units	8 maximum	
Transmission standard	RS-485 standard	
Maximum total extension distance	500 m (1640' 5") or less [50 m (164' 0") or less when 485BD is included in system]	Distance varies depending on communication equipment type.
Protocol type	N:N Network	
Control procedure	—	
Communication method	Half-duplex, bidirectional communication	
Baud rate	38400 bps	
Character format	Fixed	
Start bit		
Data bit		
Parity bit		
Stop bit		
Header	Fixed	
Terminator		
Control line	—	
Sum check	Fixed	

A

Common Items

B

N:N Network

C

Parallel Link

D

Computer Link

E

Inverter Communication

F

Non-Protocol Communication (RS/RS2 Instruction)

G

Non-Protocol Communication (FX2N-232IF)

H

Programming Communication

I

Remote Maintenance

2.2 Link Specifications

2.2.1 Link patterns and number of link points in each FX Series

The number of occupied link points varies depending on the number of used slave stations.
 For example, when three slave stations are connected in "Pattern 1", M1000 to M1223 and D0 to D33 are occupied, and unoccupied devices can be used as general devices for control.

(Link devices for unconnected slave stations can be used as general devices for control, but it is recommended to leave them in the unoccupied status if slave stations may be added in the future.)

✓: Applicable, —: Not applicable

PLC Series	Pattern 0	Pattern 1	Pattern 2
FX3UC Series	✓	✓	✓
FX3U Series	✓	✓	✓
FX2NC Series	✓	✓	✓
FX2N Series	✓	✓	✓
FX1NC Series	✓	✓	✓
FX1N Series	✓	✓	✓
FX1S Series	✓	—	—
FX0N Series	✓	—	—

Station No.		Pattern 0		Pattern 1		Pattern 2	
		Bit device (M)	Word device (D)	Bit device (M)	Word device (D)	Bit device (M)	Word device (D)
		0	4 in each station	32 in each station	4 in each station	64 in each station	8 in each station
Master station	Station No. 0	—	D 0 to D 3	M1000 to M1031	D 0 to D 3	M1000 to M1063	D 0 to D 7
	Station No. 1	—	D10 to D13	M1064 to M1095	D10 to D13	M1064 to M1127	D10 to D17
slave stations	Station No. 2	—	D20 to D23	M1128 to M1159	D20 to D23	M1128 to M1191	D20 to D27
	Station No. 3	—	D30 to D33	M1192 to M1223	D30 to D33	M1192 to M1255	D30 to D37
	Station No. 4	—	D40 to D43	M1256 to M1287	D40 to D43	M1256 to M1319	D40 to D47
	Station No. 5	—	D50 to D53	M1320 to M1351	D50 to D53	M1320 to M1383	D50 to D57
	Station No. 6	—	D60 to D63	M1384 to M1415	D60 to D63	M1384 to M1447	D60 to D67
	Station No. 7	—	D70 to D73	M1448 to M1479	D70 to D73	M1448 to M1511	D70 to D77

2.2.2 Link time

The link time indicates the cycle time in which link devices are updated.
 The link time varies depending on the number of linked units (master station and slave stations) and the number of linked devices as shown in the table below.

Unit: ms

Number of linked stations	Pattern 0	Pattern 1	Pattern 2
	0 bit-devices 4 word-devices	32 bit-devices 4 word-devices	64 bit-devices 8 word-devices
2	18	22	34
3	26	32	50
4	33	42	66
5	41	52	83
6	49	62	99
7	57	72	115
8	65	82	131

A	Common Items
B	N:N Network
C	Parallel Link
D	Computer Link
E	Inverter Communication
F	Non-Protocol Communication (RS/RS2 Instruction)
G	Non-Protocol Communication (FX2N-232IF)
H	Programming Communication
I	Remote Maintenance

3. System Configuration and Equipment Selection

This chapter explains the configuration of communication equipment operating in accordance with RS-485 and the selection of system required by FX PLCs.

3.1 System Configuration

This section explains the outline of system configuration required to use the N:N Network. Connect (optional) equipment operating in accordance with RS-485 to the FX PLC main unit.

1, **2** and **3** indicate the pattern types of combination of communication equipment.

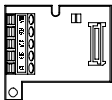
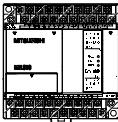
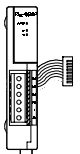
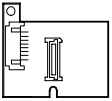
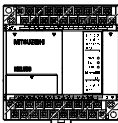
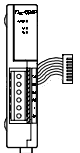
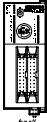
	Communication equipment operating in accordance with RS-485	FX PLC	Important point in selection	Total extension distance	
1			Because it can be built inside a PLC, the installation area is not changed.	50 m (164' 0")	
	Communication board				
2				Attach the special adapter connection board to the main unit, and then attach the communication adapter on the left side of the main unit.	500 m (1640' 5")
	Communication adapter	Special adapter connection board			
3			Attach the communication adapter on the left side of the main unit.	500 m (1640' 5")	
	Communication adapter				





For combinations of communication equipment for each FX Series, refer to the next page.





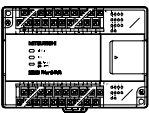

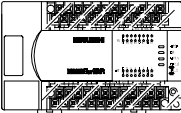
3.2 Applicable FX PLC and Communication Equipment



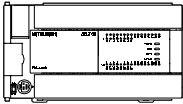
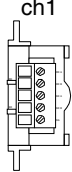

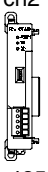
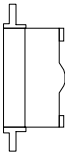

Select a combination of (optional) communication equipment, and write a check mark in the "Check" column. In selection, pay attention to the following:

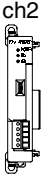
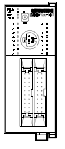
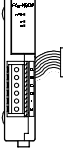
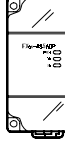
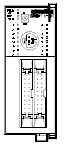
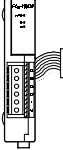
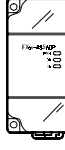
- In the table below, only the external dimensions are different between units of shown in "485ADP/485ADP". Select either one.
- N:N Network is not provided in the FX0, FX0S, FX1, FX2(FX) and FX2C Series.

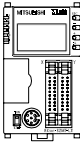
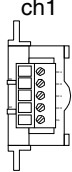
FX Series	Communication equipment (option)	Total extension distance	Check
 FX0N	 FX2NC-485ADP (European terminal block) / FX0N-485ADP (Terminal block)	500 m (1640' 5")	
 FX1s	 FX1N-485-BD (European terminal block)	50 m (164' 0")	
	 FX1N-CNV-BD (European terminal block) + FX2NC-485ADP (European terminal block) / FX1N-CNV-BD (European terminal block) + FX0N-485ADP (Terminal block)	500 m (1640' 5")	
 FX1N	 FX1N-485-BD (European terminal block)	50 m (164' 0")	
	 FX1N-CNV-BD (European terminal block) + FX2NC-485ADP (European terminal block) / FX1N-CNV-BD (European terminal block) + FX0N-485ADP (Terminal block)	500 m (1640' 5")	
 FX2N	 FX2N-485-BD	50 m (164' 0")	
	 FX2N-CNV-BD (European terminal block) + FX2NC-485ADP (European terminal block) / FX2N-CNV-BD (European terminal block) + FX0N-485ADP (Terminal block)	500 m (1640' 5")	

A	Common Items
B	N:N Network
C	Parallel Link
D	Computer Link
E	Inverter Communication
F	Non-Protocol Communication (RS/RS2 Instruction)
G	Non-Protocol Communication (FX2N-232IF)
H	Programming Communication
I	Remote Maintenance

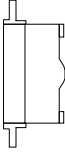
FX Series	Communication equipment (option)	Total extension distance	Check
 <p>FX3U</p>	When using channel 1 (ch 1)		
	 <p>ch1</p> <p>FX3U-485-BD (European terminal block)</p>	<p>50 m (164' 0")</p>	
	 <p>FX3U-CNV-BD</p> <p>+</p>  <p>ch1</p> <p>FX3U-485ADP (European terminal block)</p>	<p>500 m (1640' 5")</p>	
	When using channel 2 (ch 2)		
	 <p>ch1</p> <p>FX3U-□-BD (One is put in □ among 232, 422, 485, and USB).</p> <p>+</p>  <p>ch2</p> <p>FX3U-485ADP (European terminal block)</p>	<p>500 m (1640' 5")</p>	
 <p>FX3U-CNV-BD</p> <p>+</p>  <p>ch1</p> <p>FX3U-□ADP (One is put in □ among 232 and 485).</p> <p>+</p>  <p>ch2</p> <p>FX3U-485ADP (European terminal block)</p>	<p>500 m (1640' 5")</p>		
 <p>FX1NC</p>	 <p>FX2NC-485ADP (European terminal block)</p> <p>/</p>  <p>FX0N-485ADP (Terminal block)</p>	<p>500 m (1640' 5")</p>	
 <p>FX2NC</p>	 <p>FX2NC-485ADP (European terminal block)</p> <p>/</p>  <p>FX0N-485ADP (Terminal block)</p>	<p>500 m (1640' 5")</p>	

FX Series	Communication equipment (option)	Total extension distance	Check
 <p>FX3UC</p>	When using channel 1 (ch 1)		
	 <p>ch1 FX3U-485-BD (European terminal block)</p>	50 m (164' 0")	
	 <p>FX3U-CNV-BD</p> <p style="text-align: center;">+</p>  <p>ch1 FX3U-485ADP (European terminal block)</p>	500 m (1640' 5")	
	When using channel 2 (ch 2)		
	 <p>ch1 FX3U-□-BD (One is put in □ among 232, 422, 485, and USB).</p> <p style="text-align: center;">+</p>  <p>ch2 FX3U-485ADP (European terminal block)</p>	500 m (1640' 5")	
	 <p>FX3U-CNV-BD</p> <p style="text-align: center;">+</p>  <p>ch1 FX3U-□-ADP (One is put in □ among 232 and 485).</p> <p style="text-align: center;">+</p>  <p>ch2 FX3U-485ADP (European terminal block)</p>	500 m (1640' 5")	

A	Common Items
B	N:N Network
C	Parallel Link
D	Computer Link
E	Inverter Communication
F	Non-Protocol Communication (RS/RS2 Instruction)
G	Non-Protocol Communication (FX2N-232IF)
H	Programming Communication
I	Remote Maintenance

4. Wiring

This chapter explains the wiring.

WIRING PRECAUTIONS



- Cut off all phases of the power source externally before installation or wiring work in order to avoid electric shock or damage of product.
- Make sure to attach the terminal cover offered as an accessory to the product before turning on the power or starting the operation after installation or wiring work.
Failure to do so may cause electric shock.

WIRING PRECAUTIONS



- Make sure to observe the precautions below in order to prevent any damage to the machine or any accident which may be caused by abnormal data written to the PLC due to the influence of noise:
 - 1) Do not lay close or bundle with the main circuit line, high-voltage line, or load line.
Otherwise, effects of noise or surge induction are likely to take place.
Keep a safe distance of least 100 mm (3.94") from the above lines during wiring.
 - 2) Ground the shield wire or shield of a shielded cable at one point on the PLC. However, do not ground at the same point as high voltage lines.
- Perform wiring properly to the FX0N/FX2N Series extension equipment of the terminal block type in accordance with the precautions below.
Failure to do so may cause electric shock, short-circuit, wire breakage, or damages to the product.
 - The disposal size of the cable end should follow the dimensions described in this manual.
 - Tightening torque should follow the torque described in this manual.
- Observe the following items to wire the lines to the European terminal board. Ignorance of the following items may cause electric shock, short circuit, disconnection, or damage of the product.
 - The disposal size of the cable end should follow the dimensions described in this manual.
 - Tightening torque should follow the torque described in this manual.
 - Twist the end of strand wire and make sure there is no loose wires.
 - Do not solder-plate the electric wire ends.
 - Do not connect electric wires of unspecified size or beyond the specified number of electric wires.
 - Fix the electric wires so that the terminal block and connected parts of electric wires are not directly stressed.

4.1 Wiring Procedure

1 Preparing for wiring

Prepare cables and terminal resistors required in the wiring.

→ For details, refer to Section 4.2.

2 Turning OFF the power to the PLC

Before starting the wiring work, make sure that the PLC power is OFF.

3 Connecting the power supply (only the FX0N-485ADP)

Connect the power supply to the 24V DC power terminal.

4 Wiring communication equipment

Connect communication equipment operating in accordance with RS-485.

→ For details, refer to Section 4.3.

4.2 Selecting Cables and Terminal Resistors

Select cables using the procedure described below.

4.2.1 Twisted pair cable

Use shielded twisted pair cables for connecting communication equipment operating in accordance with RS-485.

The table below shows recommended model names and manufacturers of cables used in wiring.

1. Recommended cables

Manufacturer	Model name	Remarks
Mitsubishi Cable Industries, Ltd.	SPEV(SB)-0.2-2P	Two-pair cable of 0.2 mm ²
	SPEV(SB)-MPC-0.2 × 3P	Three-pair cable of 0.2 mm ²
	SPEV(SB)-0.5-2P	Two-pair cable of 0.5 mm ²
Showa Electric Wire & Cable Co., Ltd.	KMPEV-SB CWS-178 0.2SQ × 2P	Two-pair cable of 0.2 mm ²
	KMPEV-SB CWS-178 0.5SQ × 2P	Two-pair cable of 0.5 mm ²
Sumitomo Electric Industries, Ltd.	DPEV SB 0.3 × 3P	Three-pair cable of 0.3 mm ²
	DPEV SB 0.5 × 3P	Three-pair cable of 0.5 mm ²
The Furukawa Electric Co., Ltd.	D-KPEV-SB 0.2 × 3P	Three-pair cable of 0.2 mm ²
	D-KPEV-SB 0.5 × 3P	Three-pair cable of 0.5 mm ²
Fujikura Ltd.	IPEV-SB 2P × 0.3 mm ²	Two-pair cable of 0.3 mm ²
	IPEV-SB 2P × 0.5 mm ²	Two-pair cable of 0.5 mm ²

2. Cable structural drawing (reference)

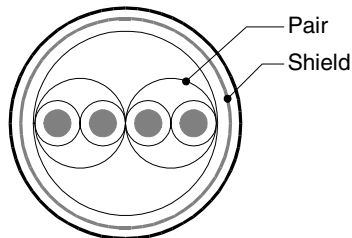

Example of two-pair cable structural drawing

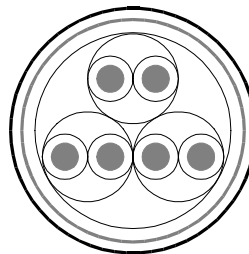

Example of three-pair cable structural drawing

4.2.2 Connecting cables

1. European type terminal block

Use shielded twisted pair cables for connecting communication equipment operating in accordance with RS-485.

The table below shows applicable cables and tightening torque.

	Cable size when one cable is connected	Cable size when two cables are connected	Cable size for bar terminal with insulating sleeve	Tightening torque	Tool size	
					A	B
FX3U-485-BD FX3U-485ADP	AWG22 to AWG20	AWG22	AWG22 to AWG20	0.22 to 0.25 N·m	0.4 (0.01")	2.5 (0.09")
FX2N-485-BD FX1N-485-BD	AWG26 to AWG16		—	0.6 N·m	0.6 (0.03")	3.5 (0.14")
FX2NC-485ADP	AWG26 to AWG16	AWG26 to AWG20	—	0.4 to 0.5 N·m	0.6 (0.03")	3.5 (0.14")

With regard to the cable end treatment, treat a stranded cable or solid cable as it is, or use a bar terminal with insulating sleeve.

- When treating a stranded cable or solid cable as it is
 - Twist the end of a stranded cable so that wires don't get barbed.
 - Do not plate the end of a cable.

FX3U-485-BD, FX3U-485ADP

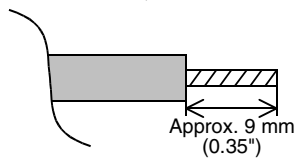

FX1N-485-BD, FX2N-485-BD

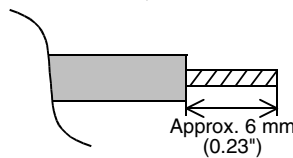

FX2NC-485ADP

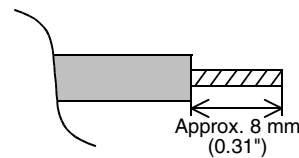

- When using a bar terminal with insulating sleeve

Because it is difficult to insert a cable into an insulating sleeve depending on the cable sheath thickness, select a proper cable according to the outline drawing.

Manufacturer	Model name	Caulking tool
Phoenix Contact	AI 0.5-8WH	CRIMPFOX UD6

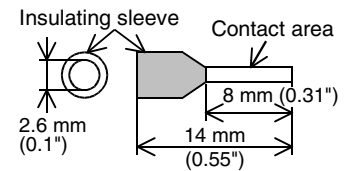

- Tool
 - When tightening a terminal on the European terminal block, use a small commercial screwdriver having straight shape whose tip is not wide as shown in the right figure.

Manufacturer	Model name
Phoenix Contact	SZS 0.4 × 2.5

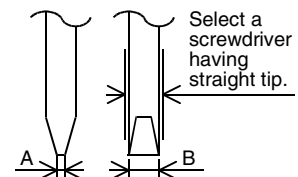

For the size A and size B, refer to the above table.

2. Terminal block

In the FX0N-485ADP and FX-485ADP, the terminal screw size is "M3". Make sure to use a crimp-style terminal having the following sizes. Make sure that the tightening torque is 0.5 to 0.8 N·m.

- When wiring one cable to one terminal

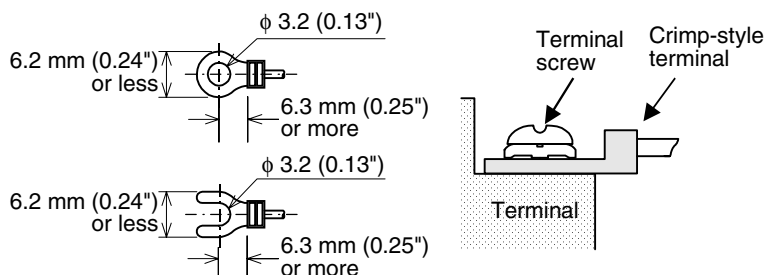

- When wiring two cables to one terminal

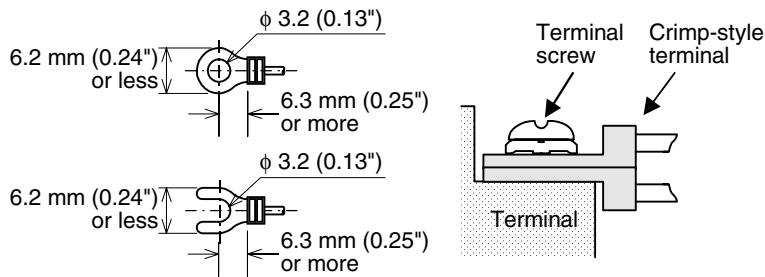

4.2.3 Connecting terminal resistors

Make sure to provide a terminal resistor at each end of a line.
 In the case of one-pair wiring, connect a terminal resistor to the RDA-RDB signal terminal in the communication equipment.

1. Terminal resistor type

Use two terminal resistors of $110\ \Omega$, $1/2\ W$.
 Among terminal resistors supplied together with the communication equipment, select ones having the color codes shown on the right.

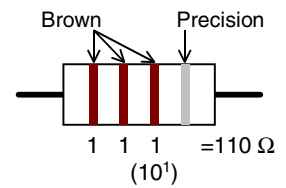

2. When using the FX3U-485-BD or FX3U-485ADP

The FX3U-485-BD and FX3U-485ADP have a built-in terminal resistor.
 Set the terminal resistor selector switch accordingly.

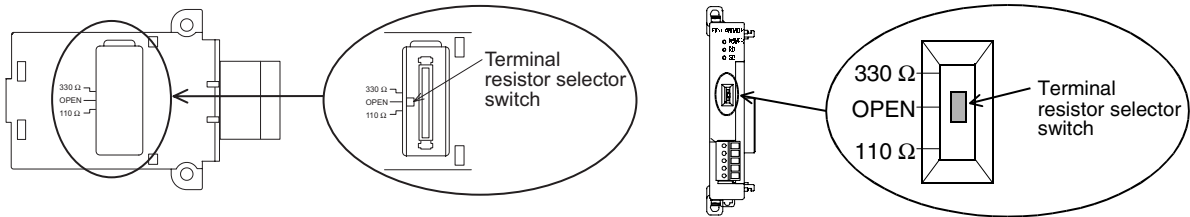

A	Common Items
B	N:N Network
C	Parallel Link
D	Computer Link
E	Inverter Communication
F	Non-Protocol Communication (RS/RS2 Instruction)
G	Non-Protocol Communication (FX2N-232IF)
H	Programming Communication
I	Remote Maintenance

4.3 Connection Diagram

Adopt one-pair wiring in N:N Network.

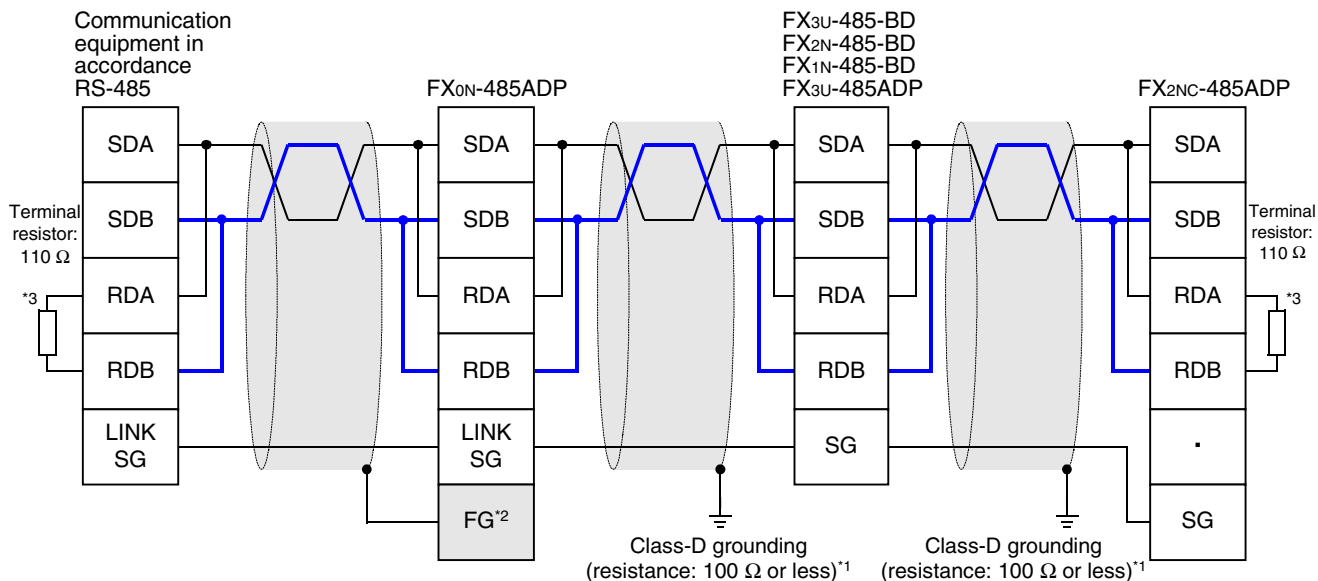

*1 Make sure to perform Class-D grounding to the shield of a twisted pair cable connected to the FX2N-485-BD, FX1N-485-BD, FX3U-485-BD, FX2NC-485-ADP or FX3U-485ADP.

*2 Make sure to connect the **FG** terminal to the **⏏** (grounding) terminal in the PLC requiring Class-D grounding. If the grounding terminal is not provided in the PLC, directly perform Class-D grounding.

*3 Make sure to provide a terminal resistor at each end of a line.
 • The FX3U-485-BD and FX3U-485ADP have a built-in terminal resistor. Set the terminal resistor selector switch accordingly.
 • The FX0N-485ADP, FX2NC-485ADP, FX2N-485-BD and FX1N-485-BD are supplied together with terminal resistors.

4.4 Grounding

Grounding should be performed as stated below.

- The grounding resistance should be 100Ω or less.
- Independent grounding should be performed for best results. When independent grounding can not be performed, perform "shared grounding" as shown in the following figure.

→ For details, refer to the Hardware Edition of each series.

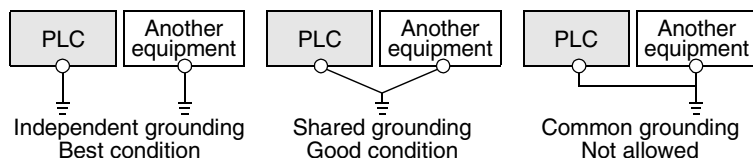

- The grounding wire size should be AWG 14 (2 mm²) or larger.
- The grounding point should be close to the PLC, and all grounding wires should be as short as possible.

A	Common Items
B	N:N Network
C	Parallel Link
D	Computer Link
E	Inverter Communication
F	Non-Protocol Communication (RS/RS2 Instruction)
G	Non-Protocol Communication (FX2N-232IF)
H	Programming Communication
I	Remote Maintenance

5. Communication Setting (Initialization) in FX Programmable Controller

The communication setting is not required in FX PLCs for the N:N network. Using the following procedure, verify that the communication setting is not specified for another communication type and verify that the setting is correct. When using the N:N Network in ch2 in an FX3U or FX3UC PLC, check D8420 using the following procedure.

5.1 Check Procedure

1 Monitoring D8120

Turn ON the power to the PLC while it is in STOP mode, and monitor D8120.

- 1. When the value of D8120 is "0"**
The communication setting is not provided.
- 2. When the value of D8120 is any value other than "0"**
The communication setting is provided.

2 Checking absence/presence of parameter setting

Check absence/presence by GX Developer or FXGP/WIN.

- 1) GX Developer operating procedure (For details, refer to Section 5.2.)
- 2) FXGP/WIN operating procedure (For details, refer to Section 5.3.)

3 Checking absence/presence of sequence program setting

Verify that an instruction for writing a value to D8120 is programmed or not.

1. When such an instruction is programmed

Program example:

Change the program as shown below, and then change the PLC mode from STOP to RUN.

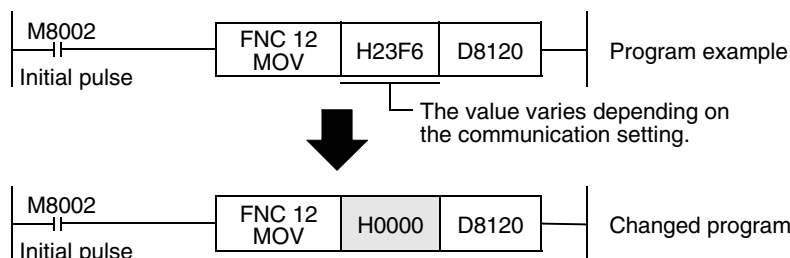

- 2. When such an instruction is not programmed**
Proceed to the next step.

4 Monitoring D8120 again, and confirming that its value is "0"

5.2 Communication Setting in Parameter Method (GX Developer)

Communication settings may be changed by the parameter method with GX Developer and FXGP/WIN for Windows. This section describes how to change parameters with GX Developer.

5.2.1 Operating procedure

With GX Developer open, follow the steps in this section for activating the serial communication setting method.

1 Opening the parameter setting window

Double-click [Parameter] - [PLC parameter] from the project tree.

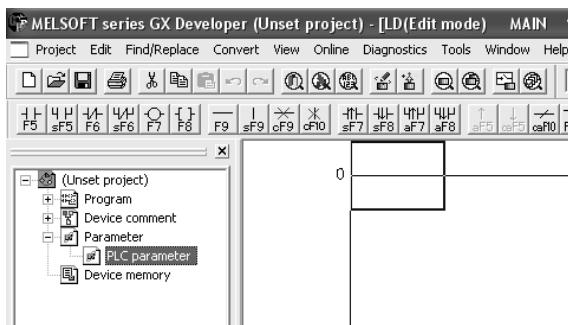

If the project tree is not displayed, select [View] - [Project data list] from the tool menu (to display a check mark on the left side).

2 Setting the serial communication (parameters)

Select a channel to be used, and click the [PLC system(2)] tab on the dialog box. Make sure that a check mark is not provided in the check box "Operate communication setting". If a check mark is provided, delete it.

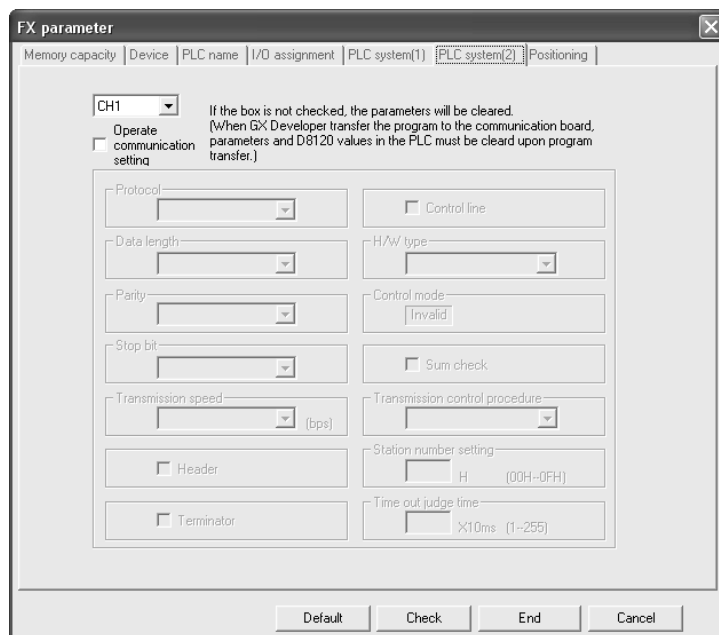

3 Writing parameters and program to the PLC

Select [Online] - [Write to PLC] from the tool menu, put a check mark (✓) in "Parameter" and "Program", and then click [Execute].

5.3 Communication Settings in Parameter Method (FXGP/WIN)

Communication settings may be changed by the parameter method with GX Developer and FXGP/WIN for Windows. This section describes how to change parameters with FXGP/WIN. Ch2 cannot be set using FXGP/WIN.

5.3.1 Operating procedure

This subsection explains the serial communication setting method. Suppose that FXGP/WIN is already started up.

1 Executing serial communication (parameter) setting

Double-click [Option]-[Serial setting (parameter)] from the tool menu. The following dialog appears according to absence/presence of parameter setting.

1. When there are no parameter settings

The dialog box shown below appears to indicate that there is no communication setting. Click the [No] button. In this case, the next step is not required.

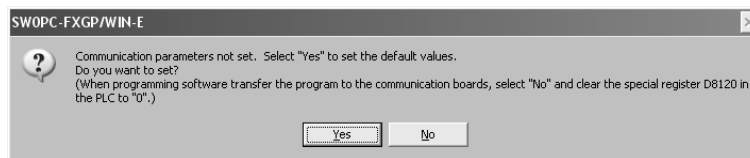

2. When there are already parameter settings

The dialog box shown below appears to indicate that there is communication setting. Click the [Clear] button to delete the communication setting from parameters. Transfer parameters to the PLC using the following step.

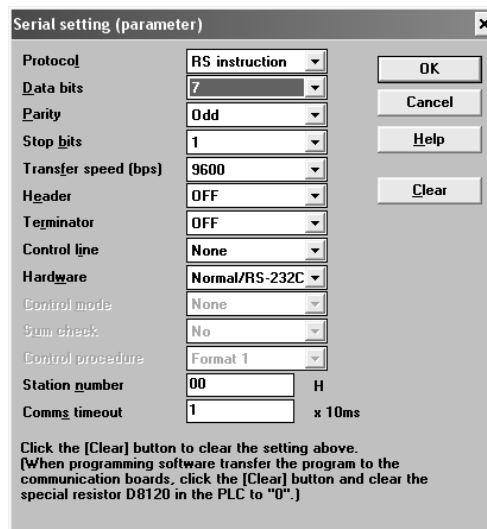

2 Writing a sequence program (parameters) to the PLC

Select [PLC] - [Transfers] - [Write] from the tool menu, and click [OK].

A	Common Items
B	N:N Network
C	Parallel Link
D	Computer Link
E	Inverter Communication
F	Non-Protocol Communication (RS/RS2 Instruction)
G	Non-Protocol Communication (FX2N-232IF)
H	Programming Communication
I	Remote Maintenance

6. Test Run (Communication Test) and Judgement Method

This chapter explains the communication test procedures for the N:N Network. It is recommended to wire the master station and slave stations, execute communication setting (initialization) in PLCs, and then execute the communication test using the following procedure to confirm the operations.

6.1 Test Procedure

1 Creating programs for communication test

Create new programs for communication test for the master station and slave stations.
→ For program examples, refer to Section 6.2.

2 Transferring the program to each PLC

Turn ON the power of each PLC, and transfer the program.

3 Validating the communication setting

When the PLC is in RUN mode, set it to STOP mode once, and then set it to RUN mode again. Or turn OFF the power of the master station and all slave stations in communication, and then turn ON the power of these stations at the same time.

4 Confirming flashing of the communication status indicator lamps (SD and RD)

Confirm that the SD and RD lamps built in the communication equipment are flashing. If they are off, take proper action while referring to the troubleshooting procedures described later.

5 Confirming the link of the master station

Set to ON or OFF the PLC inputs (X000 to X003) in the master station, and confirm that the outputs (Y000 to Y003) turn ON or OFF in each slave station.

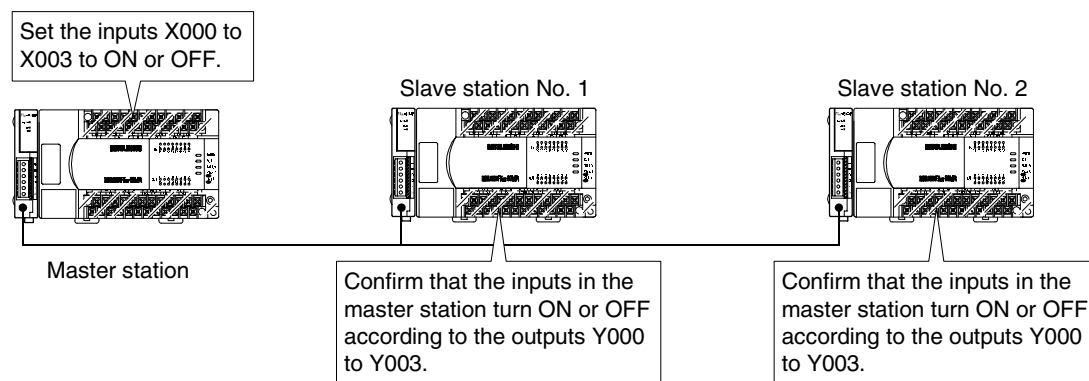

6 Confirming the link of slave stations

Set to ON or OFF the PLC inputs (X000 to X003) in each slave station, and confirm that the outputs (Y004 to Y007, Y010 to Y013, Y014 to Y017... Y030 to Y033) turn ON or OFF in each slave station.

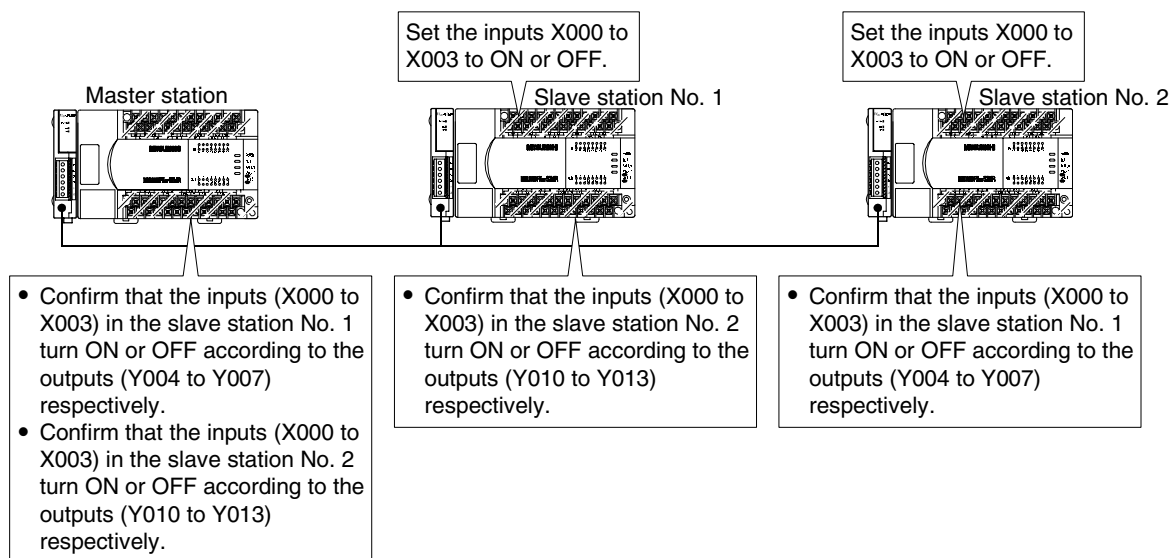

→ When the link is disabled, refer to "Chapter 9. Troubleshooting."

Assignment of inputs and outputs (link devices)

The table below shows devices used in the test programs shown later:

Station No.	Input (X)	Link device	Output (Y)
0	Master station	D0	Y000 to Y003
1	Slave station No. 1	D10	Y004 to Y007
2	Slave station No. 2	D20	Y010 to Y013
3	Slave station No. 3	D30	Y014 to Y017
4	Slave station No. 4	D40	Y020 to Y023
5	Slave station No. 5	D50	Y024 to Y027
6	Slave station No. 6	D60	Y030 to Y033
7	Slave station No. 7	D70	Y034 to Y037

A

Common Items

B

N:N Network

C

Parallel Link

D

Computer Link

E

Inverter Communication

F

Non-Protocol Communication (RS/R52 Instruction)

G

Non-Protocol Communication (FX2N-232IF)

H

Programming Communication

I

Remote Maintenance

6.2 Creating Programs for Communication Test

Create the programs shown below for the master station and each slave station.
 (In the communication test, set the refresh range to the pattern 0.)

6.2.1 Creating a program for master station

Create the program shown below for the communication test. (This program is not required during actual operation.)

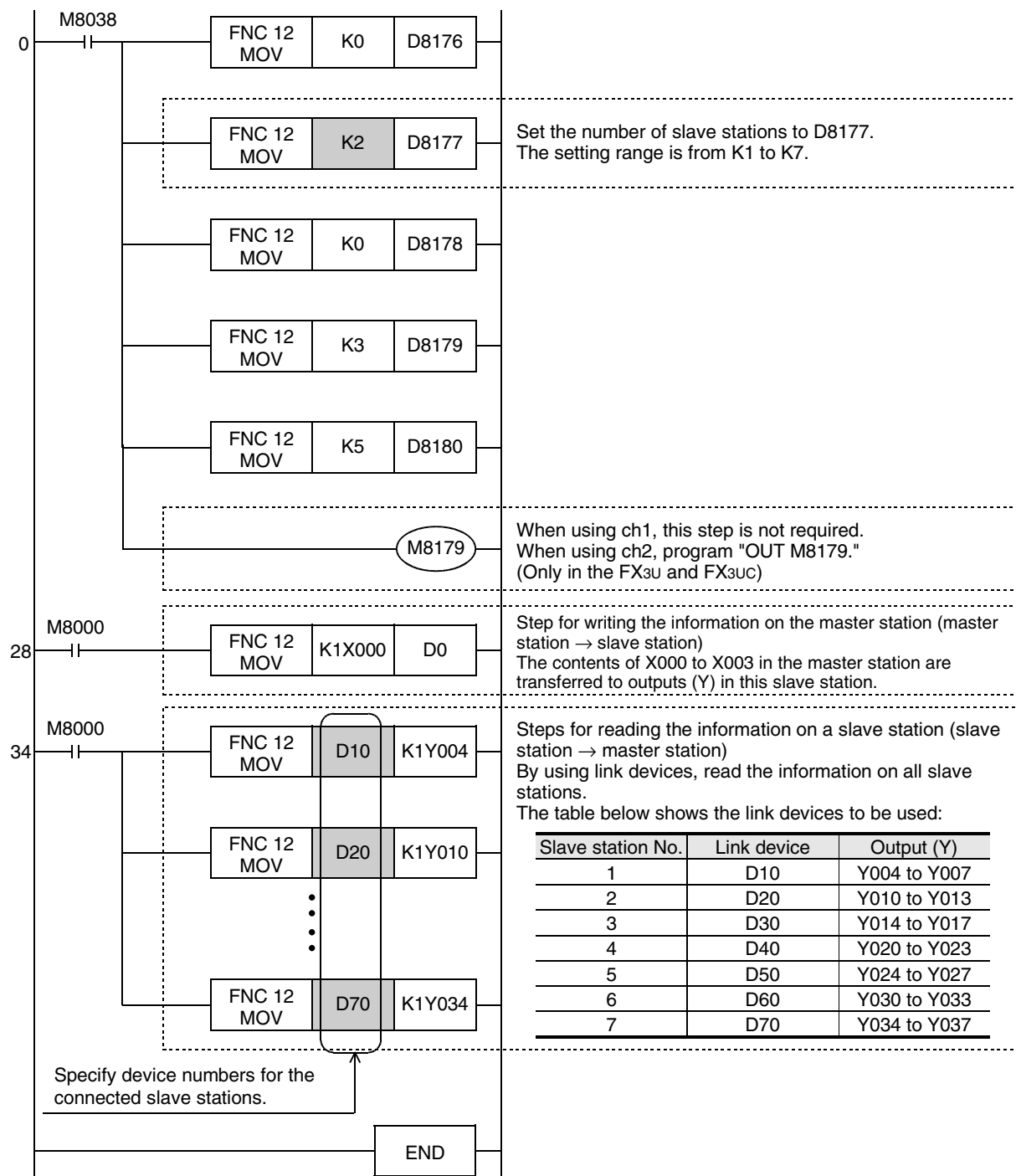

Cautions

- 1) When using a PLC (such as an FX1S Series PLC) having small number of outputs, transfer the information on slave stations to auxiliary relays (M), etc., and then monitor the auxiliary relays using a programming tool. (Example: Change "K1Y004" to "K1M4".)
- 2) In the circuit from the step 34, create a program for link devices (MOV instruction) for all connected slave stations.

6.2.2 Creating a program for each slave station.

Create the program shown below for the communication test. (This program is not required during actual operation.)

Determine the station number of each slave station, and then transfer a program corresponding to the station number to each slave station.

Assign the station number from "1" in the ascending order. (Use one station number only once. Do not skip station numbers.)

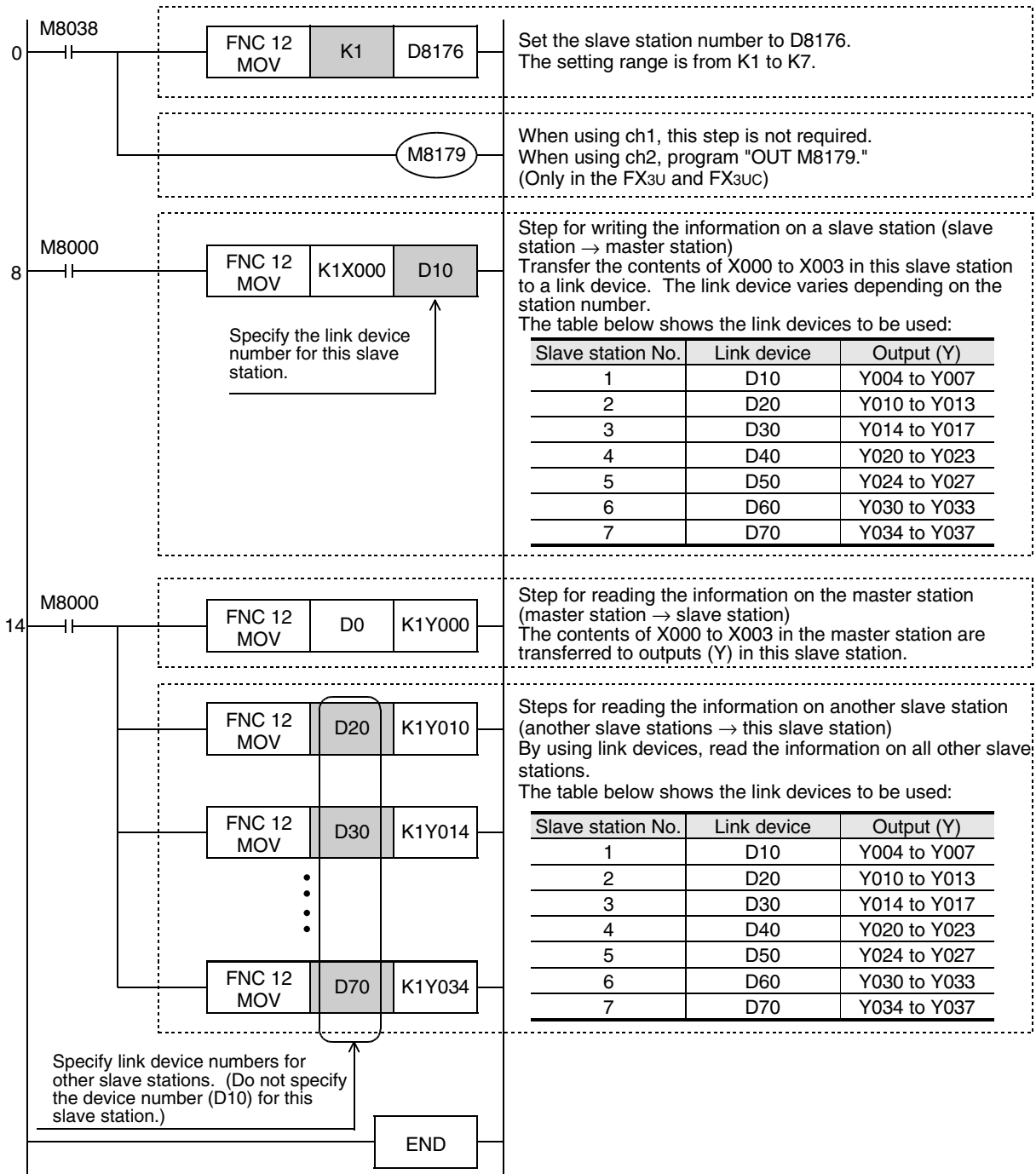

Cautions

- 1) When using a PLC (such as an FX1S Series PLC) having small number of outputs, transfer the information on slave stations to auxiliary relays (M), etc., and then monitor the auxiliary relays using a programming tool. (Example: Change "K1Y004" to "K1M4".)
- 2) In the circuit from the step 14, specify link devices for other slave stations.

7. Creating Programs

This chapter explains how to set the N:N Network and how to create programs.

In N:N Network, the pattern 0, 1 or 2 can be set according to the refresh range value. The number of used devices varies depending on the pattern.

In N:N Network using (including) the FX0N or FX1S Series, only the pattern 0 is applicable.

7.1 Checking Contents of Related Devices

The tables below show devices used in the N:N Network.

1. Devices for setting N:N Network

These devices are used for setting the N:N Network. Setting of these devices is essential in using N:N Network.

Device	Name	Description	Set value
M8038	Parameter setting	This device is a flag for setting communication parameters, and is used also for checking absence/presence of N:N Network program. Do not set this device to ON in a sequence program.	
M8179	Channel setting	Set the channel of communication port to be used (in the FX3U and FX3UC). When "OUT M8179" program does not exist: ch 1 When "OUT M8179" program exists: ch 2	
D8176	Station number settings	Set the station number used in N:N Network. Master station: 0, slave station: 1 to 7 [Initial value: 0]	0 to 7
D8177	Slave station quantity setting	Set the total number of slave stations. This setting is not required in PLCs working as slave stations. [Initial value: 7]	1 to 7
D8178	Refresh range setting	Select a desired pattern of device points used in communication. This setting is not required in PLCs working as slave stations. [Initial value: 0] Only the pattern 0 is applicable when the FX0N or FX1S Series is included.	0 to 2
D8179	Number of retries	When response is not given even after communication is repeated by the specified number of times, it is regarded as an error. Errors in other stations can be checked. This setting is not required in PLCs working as slave stations. [Initial value: 3]	0 to 10
D8180	Monitoring time	Set the time (50 to 2550 ms) for judging communication error in units of "10 ms". This setting is not required in PLCs working as slave stations. [Initial value: 5]	5 to 255

2. Devices for judging errors in the N:N Network

These devices are used for judging errors in the N:N Network. Use them to output link errors to the outside and interlock sequence programs.

Used devices are different between the FX1S/FX0N Series and the FX1N/FX2N/FX3U/FX1NC/FX2NC/FX3UC Series. Use devices according to the used PLCs.

Device		Name	Description
FX0N FX1S	FX1N, FX2N, FX3U FX1NC, FX2NC, FX3UC		
M504	M8183	Master station data transfer sequence error	This device turns ON when a data transfer sequence error occurs in the master station.
M505 to M511 ^{*1}	M8184 to M8190 ^{*1}	Slave station data transfer sequence error	This device turns ON when a data transfer sequence error occurs in a slave station.
M503	M8191	Data transfer sequence ON	This device remains ON while N:N Network is executed.

*1. For FX0N and FX1S PLCs

Station No. 1: M505, Station No. 2: M506, Station No. 3: M507... Station No. 7: M511

For FX1N, FX2N, FX3U, FX1NC, FX2NC and FX3UC PLCs

Station No. 1: M8184, Station No. 2: M8185, Station No. 3: M8186... Station No. 7: M8190

3. Link devices

These devices are used for sending and receiving the information among PLCs. The used device numbers and number of devices vary depending on the station number set in D8176 (station number settings) and the pattern set in D8178 (refresh range setting).

1) In the case of pattern 0

Station No.	0 (master station)	1	2	3	4	5	6	7
Word device (4 points for each station)	D0 to D3	D10 to D13	D20 to D23	D30 to D33	D40 to D43	D50 to D53	D60 to D63	D70 to D73

2) In the case of pattern 1

Station No.	0 (master station)	1	2	3	4	5	6	7
Bit devices (32 points for each station)	M1000 to M1031	M1064 to M1095	M1128 to M1159	M1192 to M1223	M1256 to M1287	M1320 to M1351	M1384 to M1415	M1448 to M1479
Word device (4 points for each station)	D0 to D3	D10 to D13	D20 to D23	D30 to D33	D40 to D43	D50 to D53	D60 to D63	D70 to D73

3) In the case of pattern 2

Station No.	0 (master station)	1	2	3	4	5	6	7
Bit devices (64 points for each station)	M1000 to M1063	M1064 to M1127	M1128 to M1191	M1192 to M1255	M1256 to M1319	M1320 to M1383	M1384 to M1447	M1448 to M1511
Word device (8 points for each station)	D0 to D7	D10 to D17	D20 to D27	D30 to D37	D40 to D47	D50 to D57	D60 to D67	D70 to D77

Caution

When creating a program, will not change the information on devices used in other stations. If such information is changed, other stations will not operate normally.

A

Common Items

B

N:N Network

C

Parallel Link

D

Computer Link

E

Inverter Communication

F

Non-Protocol Communication (RS/RS2 Instruction)

G

Non-Protocol Communication (FX2N-232IF)

H

Programming Communication

I

Remote Maintenance

7.2 Creating Programs for Master Station (Station No. 0)

Create programs for the master station.
 Arbitrarily create programs for reading and writing link devices.

Program for setting N:N Network

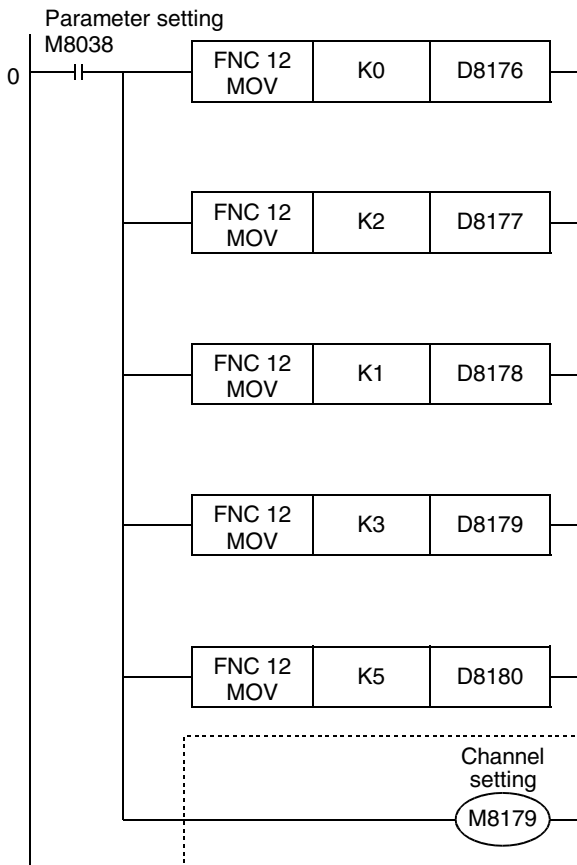

Make sure to start the program for setting the N:N Network from step 0.

Station number settings: 0 (master station)
 The station number "0" indicates the master station.

Slave station quantity setting: 2 (2 slave stations)
 Set the number of connected slave stations.
 [Setting range: 1 to 7]

Refresh range setting: 1 (pattern 1)
 Set the pattern of devices used in communication.
 [Setting range: 0 to 2]
 (Only the pattern 0 is applicable in the FX0N or FX1S Series.)

Number of retries: 3 (3 times)
 Set the number of retrying communication after which a link error is detected.
 [Setting range: 0 to 10]

Monitoring time: 5 (50 ms)
 Set the time by which communication error is judged.
 [Setting range: 5 to 255]

Channel setting
 Set the communication port to be used.
 When using ch1, this step is not required.
 When using ch2, program "OUT M8179."
 (in the FX3U and FX3UC)

Program for indicating link errors

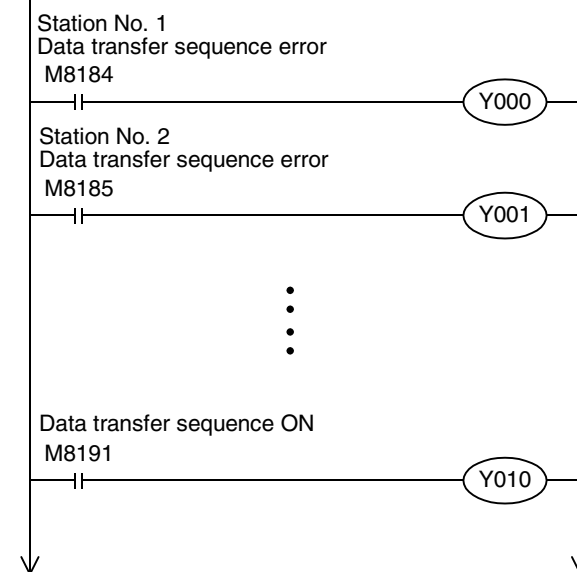

This program is required to indicate the N:N Network status.

When a link error occurs in the station No. 1, Y000 is set to ON.

When a link error occurs in the station No. 2, Y001 is set to ON.

- Create this step for each connected slave station. Note that the devices to be used are different depending on the PLC Series.
 For FX0N and FX1S Series:
 M505 to M511 (station No. 1 to station No. 7)
 In the case of any series other than FX0N and FX1S Series:
 M8184 to M8190 (station No. 1 to station No. 7)

While the N:N Network is executed, Y010 remains ON.

- Note that the devices to be used are different depending on the PLC Series.
 For FX0N and FX1S Series: M503
 In the case of any series other than FX0N and FX1S Series: M8191

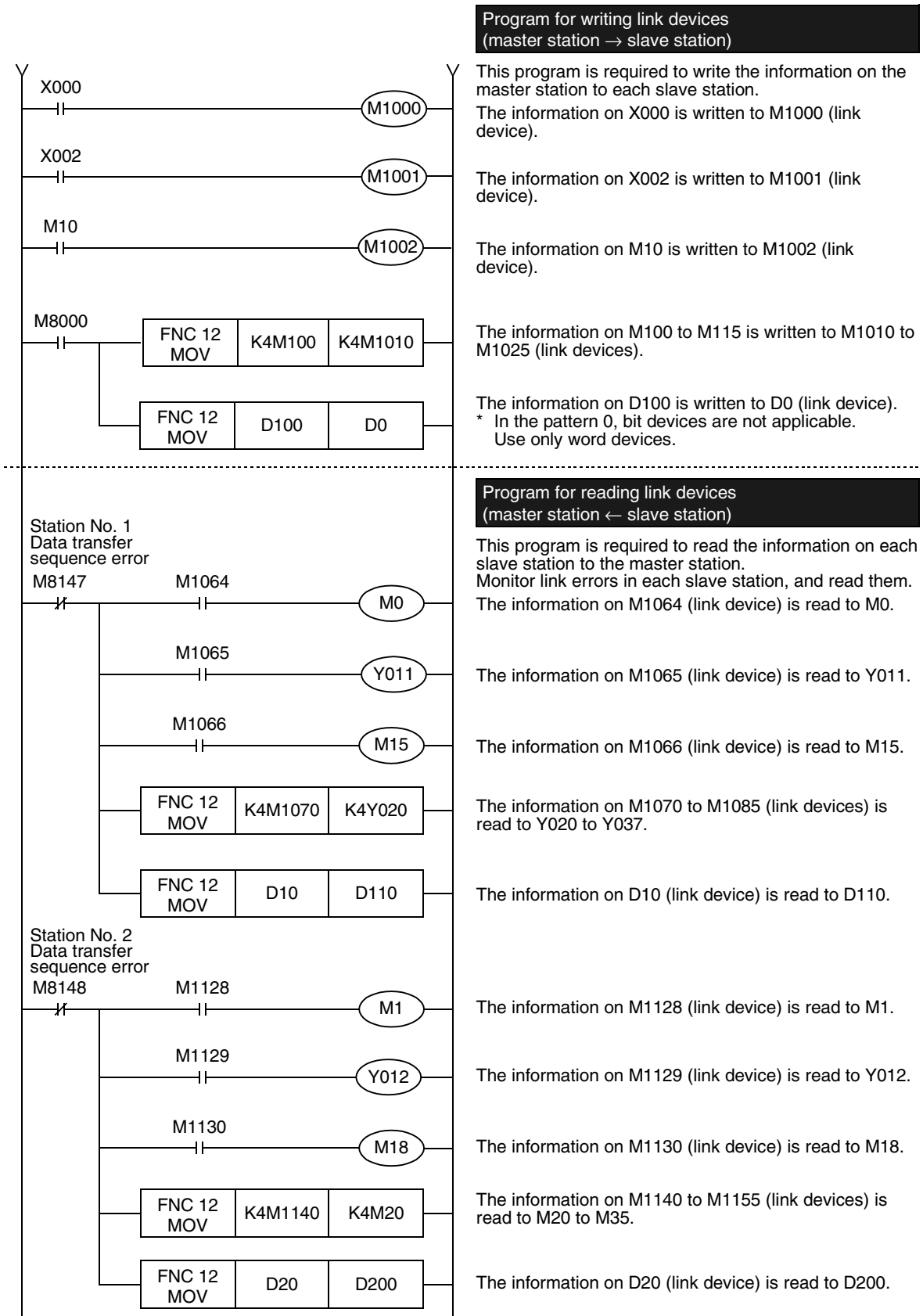

→ For details on link devices, refer to Section 7.1.
 → For cautions on program creation, refer to Section 7.4.

A	Common Items
B	N:N Network
C	Parallel Link
D	Computer Link
E	Inverter Communication
F	Non-Protocol Communication (RS/RS2 Instruction)
G	Non-Protocol Communication (FX2N-232IF)
H	Programming Communication
I	Remote Maintenance

7.3 Creating Programs for Slave Station (Station No. "n")

Create programs for the slave stations.
 Arbitrarily create programs for reading and writing link devices.

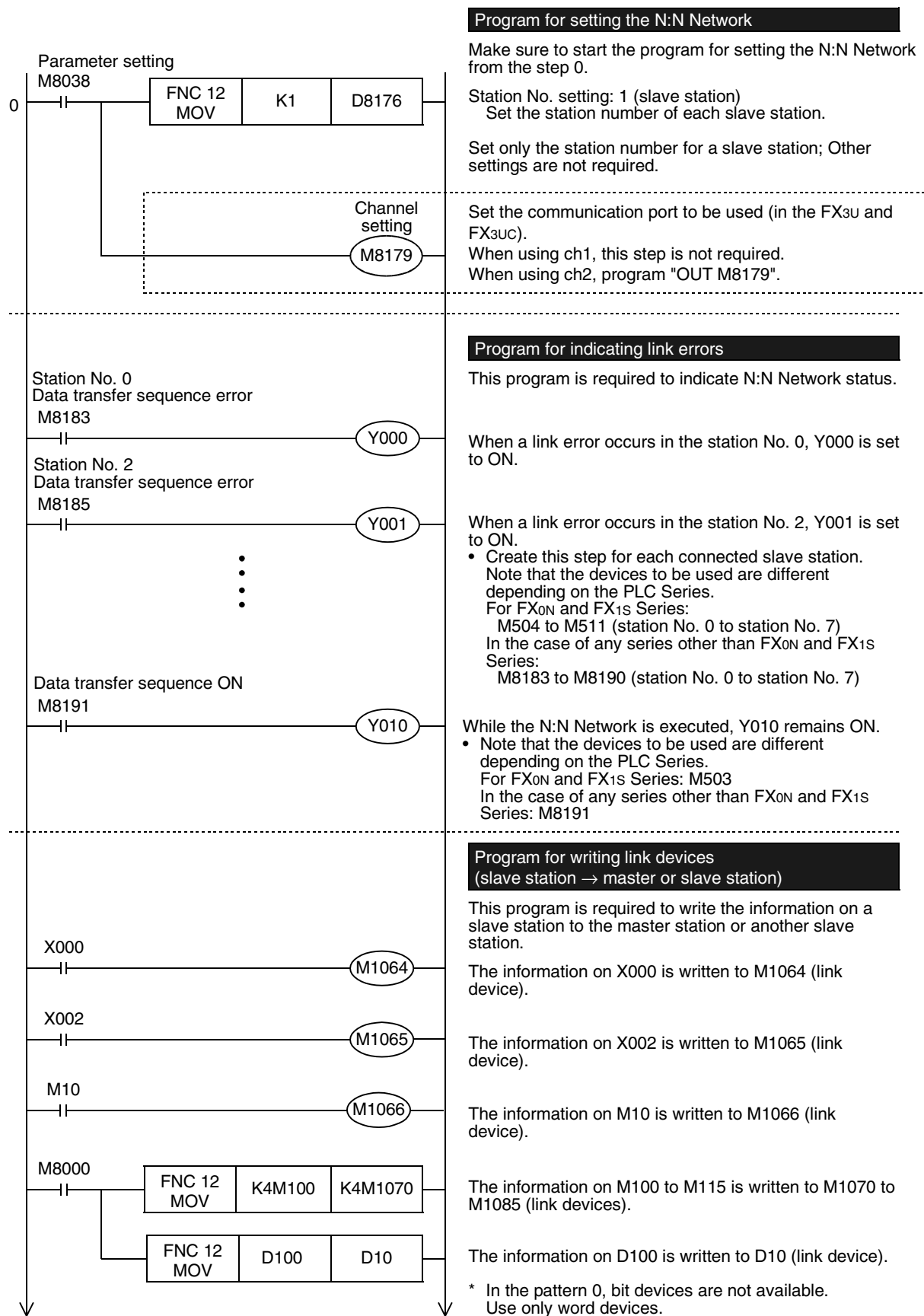

**Program for reading link devices
 (slave station ← master or slave station)**

This program is required to read the information on the master station or another slave station to a slave station. Monitor link errors in each slave station, and read them.

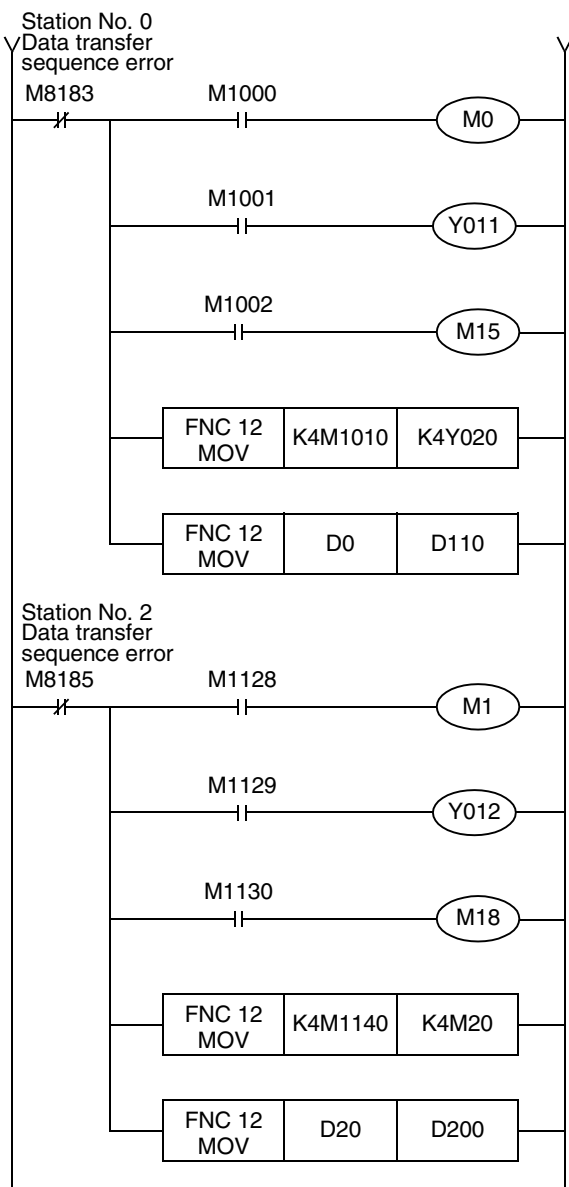

The information on M1000 (link device) is read to M0.

The information on M1001 (link device) is read to Y011.

The information on M1002 (link device) is read to M15.

The information on M1010 to M1025 (link devices) is read to Y020 to Y037.

The information on D0 (link device) is read to D110.

The information on D1128 (link device) is read to M1.

The information on D1129 (link device) is read to Y012.

The information on D1130 (link device) is read to M18.

The information on M1140 to M1155 (link devices) is read to M20 to M35.

The information on D20 (link device) is read to D200.

→ For details on link devices, refer to Section 7.1.
 → For cautions on program creation, refer to Section 7.4.

A	Common Items
B	N:N Network
C	Parallel Link
D	Computer Link
E	Inverter Communication
F	Non-Protocol Communication (RS/RS2 Instruction)
G	Non-Protocol Communication (FX2N-232IF)
H	Programming Communication
I	Remote Maintenance

7.4 Cautions on Program Creation

1. Effect on the operation cycle

When the N:N Network is used, the operation cycle in each PLC becomes longer by about 10% without regarding the number of linked stations and adopted communication patterns.

2. Program for setting N:N Network

- 1) Make sure to create a program for setting the N:N Network from the step 0 using M8038 (drive contact). Otherwise, the N:N Network is disabled.
- 2) Do not set M8038 to ON using a program or programming tool.
- 3) Set station numbers continuously. If a station number that is used twice or more is skipped, link is not achieved normally.

3. Program for reading link devices

Do not change the contents of link devices at other stations.

- 1) When a link error (data transfer sequence error) occurs, the link device information is held in the status just before occurrence of the link error.
Create a fail-safe program which does not cause abnormality even if a link error occurs.

4. Cautions on using FX1S/FX0N PLCs

- 1) Link pattern when FX1S/FX0N PLCs are used or included
When FX1S/FX0N PLCs are included in the system, make sure to set the pattern 0 in D8178 (refresh range setting).
If any other pattern is set, data transfer error occurs in all FX1S/FX0N PLCs included in the system, and the link time becomes longer.
- 2) When user devices are occupied as system devices
In FX1S/FX0N PLCs, M503 to M511 and D201 to D255 are handled as devices dedicated to the N:N Network, and cannot be handled as general devices any more. Do not set these devices to ON or OFF using a user program, display unit or programming tool.
If these devices are set to ON or OFF, the N:N Network may malfunction.

5. Cautions on using FX3U/FX3UC PLCs

- 1) Only ch 1 or ch 2 can be set in the N:N Network.
- 2) Do not use the N:N Network and parallel link at the same time.
(For example, it is not allowed to use ch1 for the N:N Network and use ch2 for parallel link.)

8. Practical Program Examples

This chapter shows practical programs.

8.1 Practical Example 1 (Pattern 2)

This program example adopts the pattern 2 which uses the maximum number of link devices. When an FX0N or FX1S PLC is included, however, only pattern 0 is applicable.

8.1.1 System configuration example

The example below shows a system configuration in which three FX PLCs are linked.

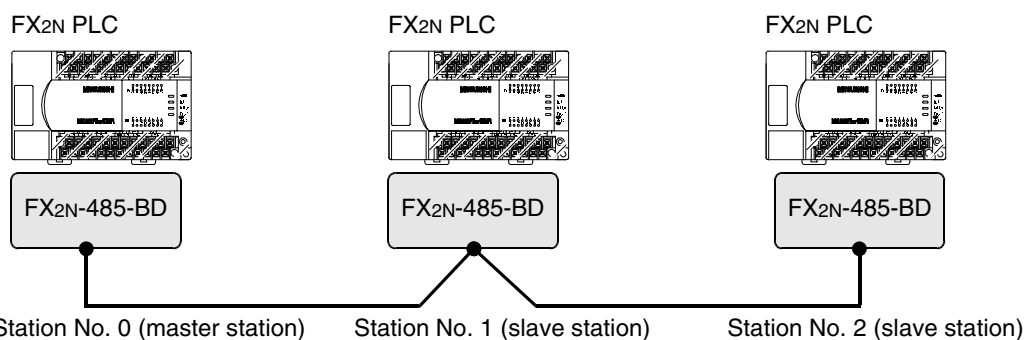

- Refresh range: 64-bit devices and 8 word devices (pattern 2)
- Number of retries: 5
- Monitoring time: 70 ms

8.1.2 Contents of operations and corresponding program numbers

The program examples shown later execute the data processing shown in the table below. The operation No. corresponds to the operation [1] (for example) indicated in the programs shown later.

Operation No.	Data source		Data change destination and contents	
Bit device link				
[1]	Master station	Inputs X000 to X003 (M1000 to M1003)	Slave station No. 1	Outputs Y010 to Y013
			Slave station No. 2	Outputs Y010 to Y013
[2]	Slave station No. 1	Inputs X000 to X003 (M1064 to M1067)	Master station	Outputs Y014 to Y017
			Slave station No. 2	Outputs Y014 to Y017
[3]	Slave station No. 2	Inputs X000 to X003 (M1128 to M1131)	Master station	Outputs Y020 to Y023
			Slave station No. 1	Outputs Y020 to Y023
Word device link				
[4]	Master station	Data register D1	Slave station No. 1	Set value of counter C1
	Slave station No. 1	Contact of counter C1 (M1070)	Master station	Output Y005
[5]	Master station	Data register D2	Slave station No. 1	Set value of counter C2
	Slave station No. 1	Contact of counter C2 (M1140)	Master station	Output Y006
[6]	Slave station No. 1	Data register D10	Master station	Slave station No. 1 (D10) + Slave station No. 2 (D20) is stored to D3.
	Slave station No. 2	Data register D20		
[7]	Master station	Data register D0	Slave station No. 1	Master station (D0) + Slave station No. 2 (D20) is stored to D11.
	Slave station No. 2	Data register D20		
[8]	Master station	Data register D0	Slave station No. 2	Master station (D0) + Slave station No. 1 (D10) is stored to D21.
	Slave station No. 1	Data register D10		

8.1.3 Setting contents

The program examples shown later adopt the following communication parameters:

System device	Master station	Station No. 1	Station No. 2	Contents
D8176	K 0	K 1	K 2	Station number settings
D8177	K 2	—	—	Total number of slave stations: 2
D8178	K 2	—	—	Refresh range: Pattern 2
D8179	K 5	—	—	Number of retries: 5
D8180	K 7	—	—	Monitoring time: 70 ms

8.1.4 Setting program for master station

For the setting program for the master station, refer to the program shown below.
 The program shown below consists of three blocks, "parameter setting program," "error indication program" and "operation program."

1. Parameter setting program

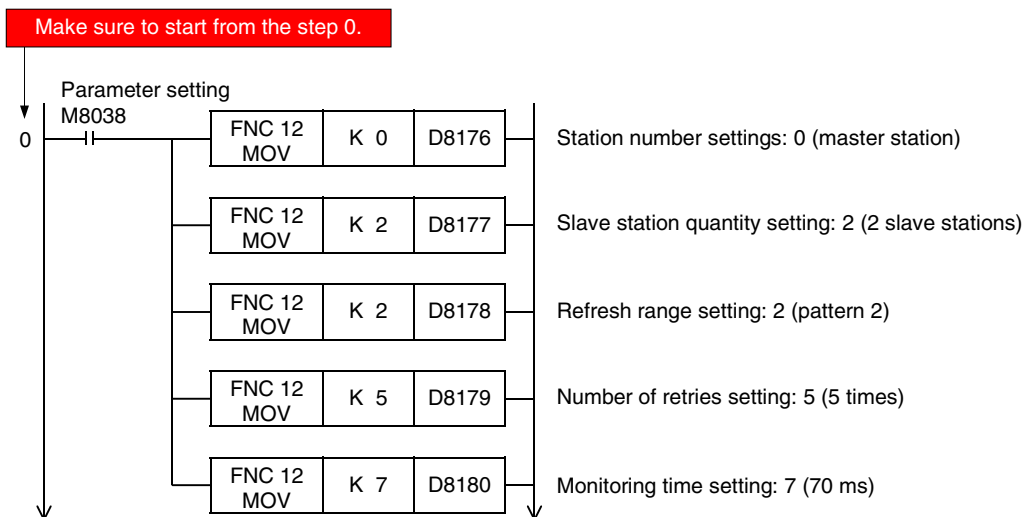

2. Error indication program

Because the master station does not recognize errors in itself (the master station), programs for errors in itself are not required.

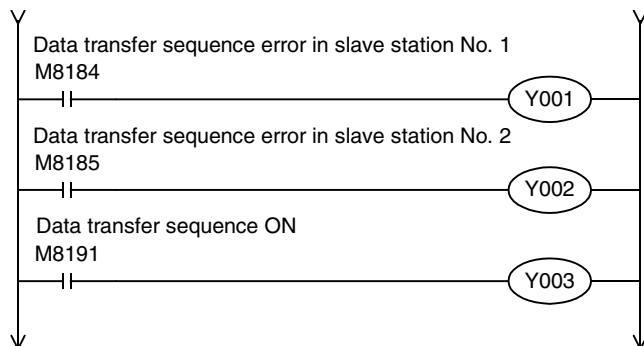

3. Operation program

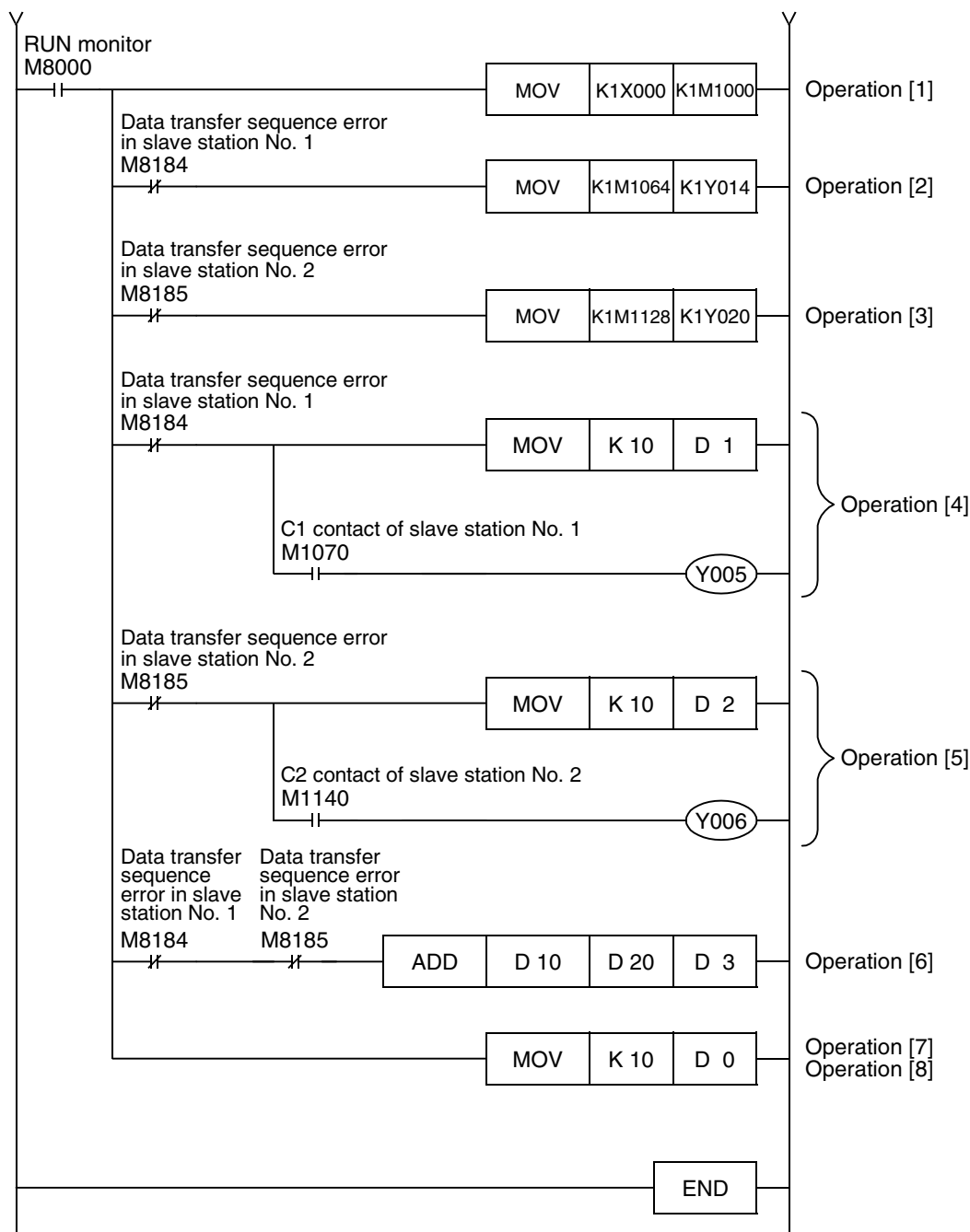

A	Common Items
B	N:N Network
C	Parallel Link
D	Computer Link
E	Inverter Communication
F	Non-Protocol Communication (RS/RS2 Instruction)
G	Non-Protocol Communication (FX2N-232IF)
H	Programming Communication
I	Remote Maintenance

8.1.5 Setting program for slave station (No. 1)

For the setting program for a slave station, refer to the program shown below.
 The program shown below consists of three blocks, "parameter setting program," "error indication program" and "operation program."

1. Parameter setting program

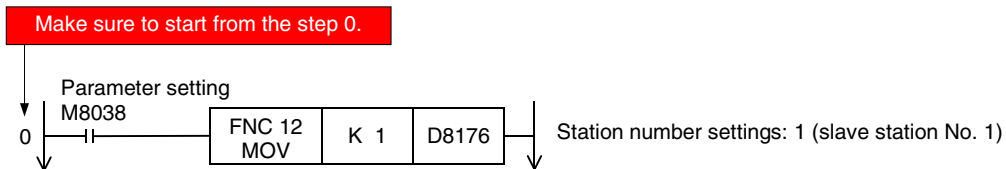

2. Error indication program

Because the slave station No. 1 does not recognize errors in itself (the slave station No. 1), any program for errors in itself is not required.

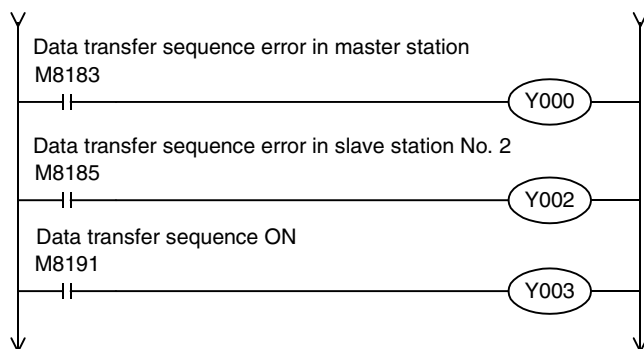

3. Operation program

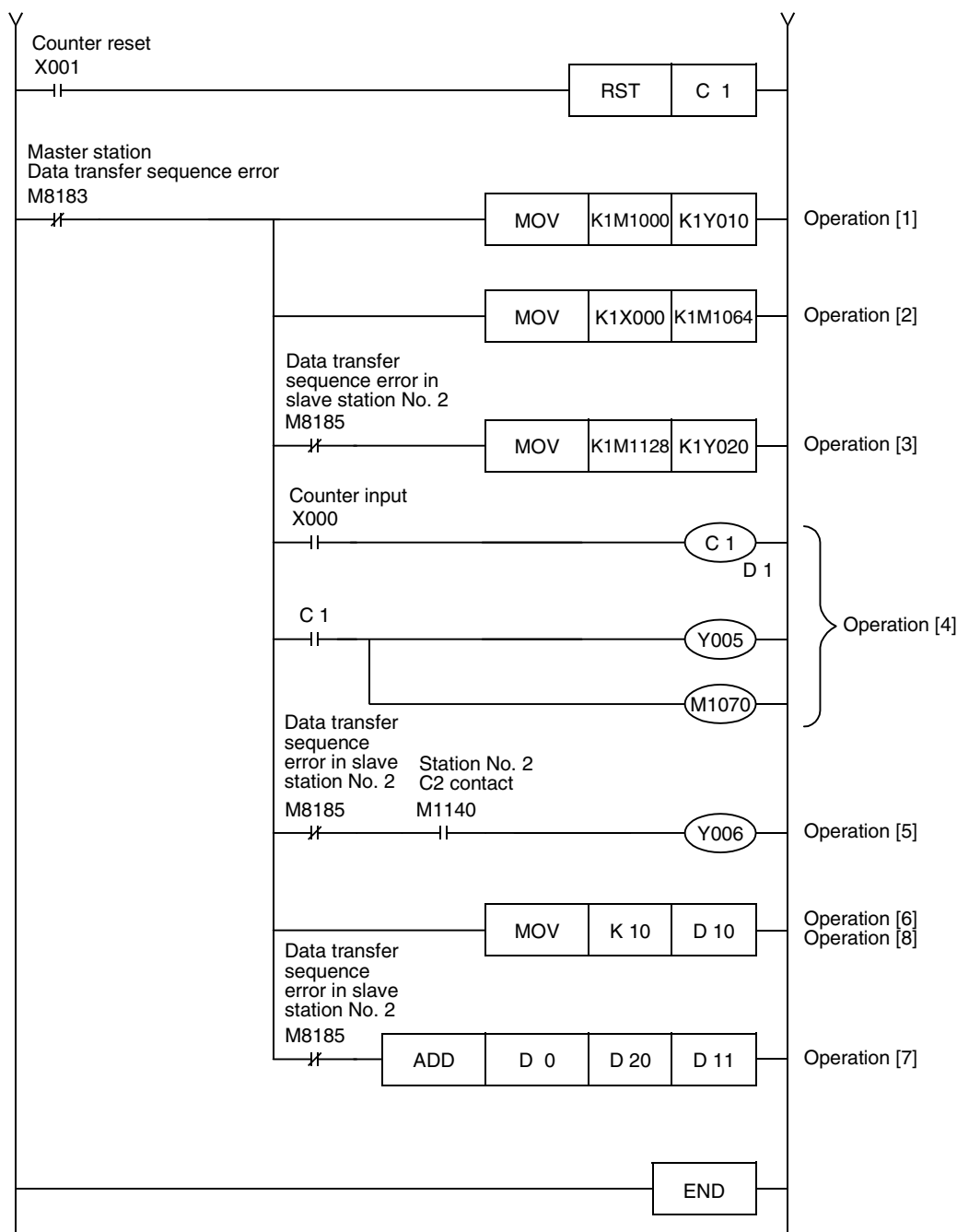

A	Common Items
B	N:N Network
C	Parallel Link
D	Computer Link
E	Inverter Communication
F	Non-Protocol Communication (RS/RS2 Instruction)
G	Non-Protocol Communication (FX2N-232IF)
H	Programming Communication
I	Remote Maintenance

8.1.6 Setting program for slave station (No. 2)

For the setting program for a slave station, refer to the program shown below.
 The program shown below consists of three blocks, "parameter setting program," "error indication program" and "operation program."

1. Parameter setting program

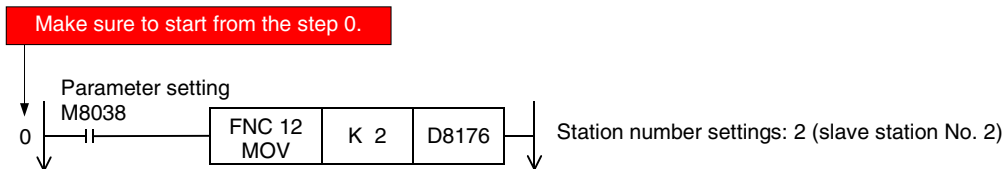

2. Error indication program

Because the slave station No. 2 does not recognize errors in itself (the slave station No. 2), programs for errors in itself are not required.

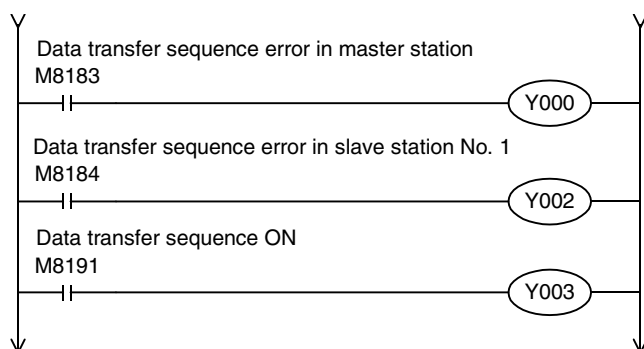

3. Operation program

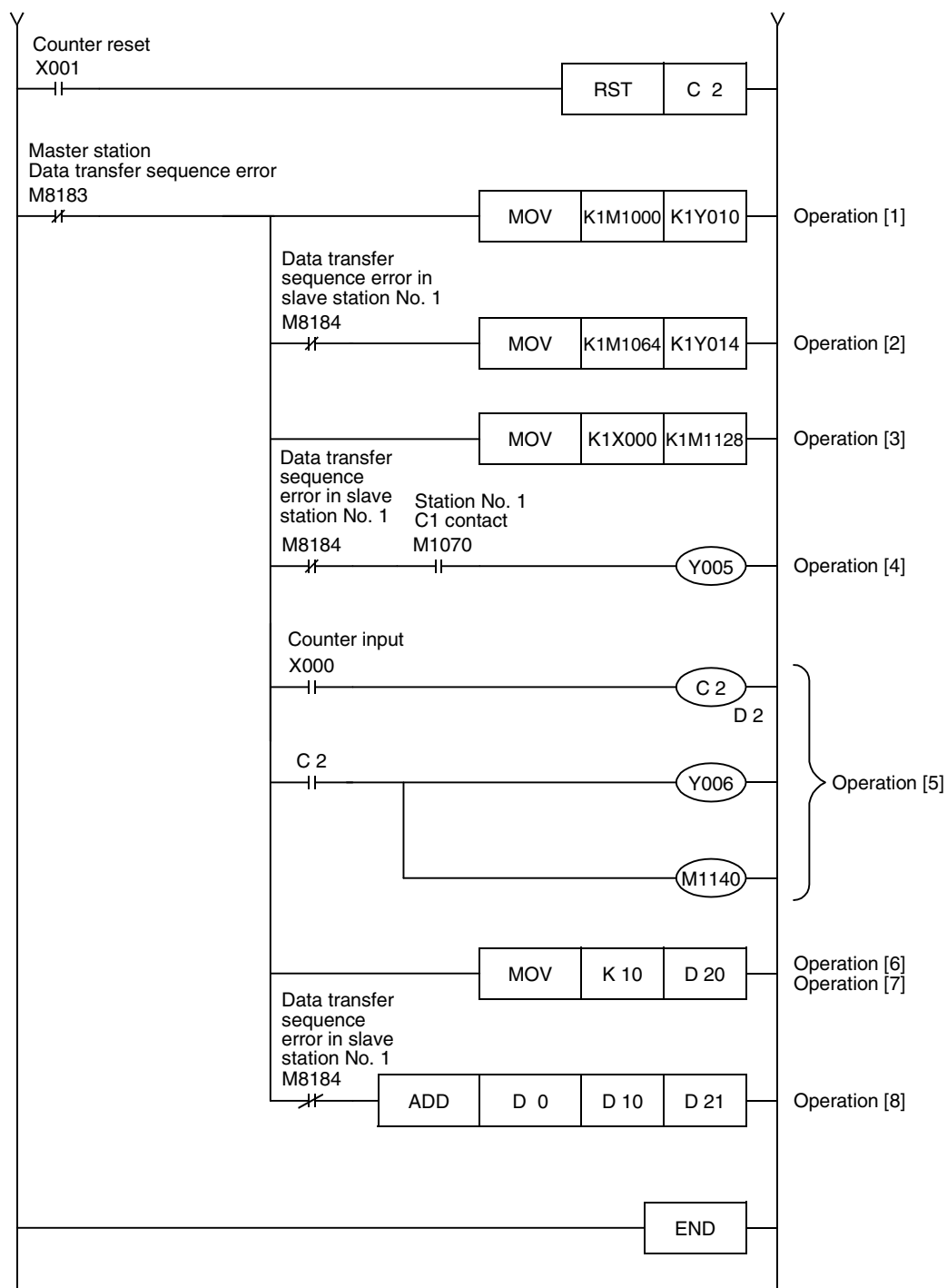

A	Common Items
B	N:N Network
C	Parallel Link
D	Computer Link
E	Inverter Communication
F	Non-Protocol Communication (RS/RS2 Instruction)
G	Non-Protocol Communication (FX2N-232IF)
H	Programming Communication
I	Remote Maintenance

9. Troubleshooting

This chapter explains troubleshooting.

9.1 Checking FX PLC Version Applicability

Verify that the FX Series PLC main unit is an applicable version.

→ For the version applicability check, refer to Section 1.3.

9.2 Checking Communication Status Based on LED Indication

Check the status of the "RD" and "SD" indicator LEDs provided in the optional equipment.

LED status		Operation status
RD	SD	
Flashing	Flashing	Data is being sent or received.
Flashing	Off	Data is received, but is not sent.
Off	Flashing	Data is sent, but is not received.
Off	Off	Data is not sent nor received.

While the N:N Network is executed normally, both LEDs flash brightly.

If they do not flash, check the wiring and the communication setting in the master and slave stations.

9.3 Checking Installation and Wiring

1. Mounting status

If the communication equipment is not securely connected to the PLC, communication is disabled.

→ For the mounting method, refer to the manual of each communication equipment.

2. Power supply (For FX0N-485ADP)

The FX0N-485ADP requires a driving power supply. Verify that the power supply is correctly provided.

3. Wiring

Verify that the wiring to each communication equipment is correct. Incorrect wiring disables communication.

→ For the wiring method check, refer to Chapter 4.

9.4 Checking Sequence Program

1. Communication setting in a sequence program

Verify that the parallel link is not set. It is not allowed to use both the parallel link and the N:N Network at the same time.

Verify that the communication format (D8120 and D8420) is set correctly. Communication is disabled if a communication port is set twice or more.

After changing any setting, make sure to reboot the PLC's power.

→ For the communication setting, refer to Chapter 5.

2. Communication setting using parameters

Verify that the communication setting parameters are suitable for use. Do not set parameters for the N:N Network. If the communication setting is not suitable for use, communication will not execute correctly. After changing a setting, make sure to reboot the PLC's power.

→ For the communication setting, refer to Chapter 5.

3. Presence of VRRD and VRSC instructions (except FX3U and FX3UC PLCs)

Verify that VRRD and VRSC instructions are not used in a program. If these instructions are used, delete them, reboot the PLC's power.

4. Presence of RS instruction (except FX3U and FX3UC PLCs)

Verify that RS instruction is not used in a program. If this instruction is used, delete it, reboot the PLC's power.

5. Presence of RS and RS2 instructions (in FX3U and FX3UC PLCs)

Verify that RS and RS2 instructions are not used in the same channel. If these instructions are used in the same channel, delete them, reboot the PLC's power.

6. Presence of EXTR instruction (in FX2N and FX2NC PLCs)

Verify that EXTR instruction is not used in a program. If this instruction is used, delete it, reboot the PLC's power.

7. Presence of IVCK, IVDR, IVRD, IVWR, and IVBWR instructions (in FX3U and FX3UC PLCs)

Verify that IVCK, IVDR, IVRD, IVWR and IVBWR instructions are not used in the same channel. If these instructions are used in the same channel, delete them, reboot the PLC's power.

9.5 Checking Setting Contents and Errors

1. Checking the setting contents

Verify that the N:N Network is set correctly.

Each FX PLC has devices for checking the setting. Verify that the correct contents are stored in the devices shown in the table below.

Device	Name	Description
D8173	Station number settings status	Provided to check the station number.
D8174	Slave station quantity setting status	Provided to check the number of slave stations.
D8175	Refresh range setting status	Provided to check the refresh range.

If the correct contents are not stored in the above devices, check the sequence program.

2. Checking setting errors (only in FX3U and FX3UC PLCs)

1) Error flags

If the parameter setting includes an error, the serial communication error flag turns ON.

Verify that the devices shown in the table below are ON.

Device	Name	Description
M8063	Serial communication error 1 (ch 1)	Turns ON when abnormality occurs in the serial communication using ch 1.
M8438	Serial communication error 2 (ch 2)	Turns ON when abnormality occurs in the serial communication using ch 2.

When using the N:N Network in ch 1, check M8063.

When using the N:N Network in ch 2, check M8438.

A	Common Items
B	N:N Network
C	Parallel Link
D	Computer Link
E	Inverter Communication
F	Non-Protocol Communication (RS/RS2 Instruction)
G	Non-Protocol Communication (FX2N-232IF)
H	Programming Communication
I	Remote Maintenance

2) Error codes

When the serial communication error flag turns ON, the error code is stored in the device shown in the table below.

Device	Name	Error code	Description
D8063	Serial communication error code 1 (ch 1)	6308	N:N Network parameter setting error
D8438	Serial communication error code 2 (ch 2)	3808	

9.6 Checking Absence/Presence of Data Transfer Errors

Verify that link errors have not occurred in the master station and slave stations. Link errors can be checked using the flags shown below.

9.6.1 Check while data transfer sequence is being executed

While the N:N Network is being executed, the data transfer sequence ON flag remains ON. Verify that the device shown in the table below is ON.

FX Series	Device	Name	Description
FX1N, FX2N, FX3U, FX1NC, FX2NC, FX3UC	M8191	Data transfer sequence ON flag	Remains ON while data transfer is being executed.
FX0N, FX1S	M503		

9.6.2 Checking data transfer sequence errors

When a link error occurs in the master station or slave station, the data transfer sequence error flag turns ON. The data transfer sequence error flag varies depending on the FX Series and station number. Refer to the table below.

FX Series	Master station	Slave station No. 1	Slave station No. 2	Slave station No. 3	Slave station No. 4	Slave station No. 5	Slave station No. 6	Slave station No. 7
FX1N, FX2N, FX3U, FX1NC, FX2NC, FX3UC	M8183	M8184	M8185	M8186	M8187	M8188	M8189	M8190
FX0N, FX1S	M504	M505	M506	M507	M508	M509	M510	M511

9.6.3 Checking error codes

When a data transfer sequence error occurs, the corresponding data transfer sequence error flag turns ON, and the error code is stored in the corresponding data register.

→ For error codes, refer to the next page.

1. Error storing device

The data register used to store the data transfer error code varies depending on the FX Series and station number. Refer to the table below.

FX Series	Master station	Slave station No. 1	Slave station No. 2	Slave station No. 3	Slave station No. 4	Slave station No. 5	Slave station No. 6	Slave station No. 7
FX1N, FX2N, FX3U, FX1NC, FX2NC, FX3UC	D8211	D8212	D8213	D8214	D8215	D8216	D8217	D8218
FX0N, FX1S	D211	D212	D213	D214	D215	D216	D217	D218

2. Error code list

The data register for storing the data transfer error code stores the corresponding error code. When a data transfer sequence error occurs, refer to the error code list shown below, and confirm the check points.

Error code	Error name	Station in which error occurred	Station which detected error	Contents of error	Check point
01H	Monitoring timeout	L	M	Slave station did not give any response to the sending request given by the master station within the monitoring timer time.	Wiring and power supply
02H	Station number error	L	M	To the sending request given by the master station, an unspecified slave station gave response.	Wiring
03H	Counter error	L	M	The counter value included in the parameter data is different from the counter value given by a slave station.	Wiring
04H	Message format error	L	M, L	The message given by a slave station is incorrect.	Wiring, power supply and station number settings
11H	Monitoring timeout	M	L	The master station did not give sending request to the next slave station within the monitoring timer.	Wiring and power supply
14H	Message format error	M	L	The message from the master station is incorrect.	Wiring, power supply and station number settings
21H	Slave station no response error	L	L ^{*1}	The specified slave station does not exist.	Wiring, power supply and station number settings
22H	Station number error	L	L ^{*1}	To the sending request given by the master station, an unspecified slave station gave response.	Wiring
23H	Counter error	L	L ^{*1}	The counter value included in the parameter data is different from the counter value given by a slave station.	Wiring
31H	Parameter not received	L	L ^{*2}	Before parameters had been received, sending request given by the master station was received.	Wiring and power supply

M: Master station, L: Slave station

- *1. Any slave station other than the slave station in which error occurred
- *2. Station in which error occurred

A	Common Items
B	N:N Network
C	Parallel Link
D	Computer Link
E	Inverter Communication
F	Non-Protocol Communication (RS/RS2 Instruction)
G	Non-Protocol Communication (FX2N-232IF)
H	Programming Communication
I	Remote Maintenance

10. Related Data

10.1 Related Device List

10.1.1 For FX1N, FX2N, FX3U, FX1NC, FX2NC, and FX3UC PLCs

1. Bit devices

Device number	Name	Description	Initial value	Detection	R/W
Devices for communication setting					
M8038	Parameter setting	Communication parameter setting flag	—	M, L	R
M8179	Channel setting	Sets the communication port channel to be used (in the FX3U and FX3UC).	—	M, L	W/R
Devices for checking communication status					
M8063	Serial communication error 1 (ch 1)	Turns ON when abnormality occurs in serial communication using ch 1 (in the FX3U and FX3UC).	—	M, L	R
M8438	Serial communication error 2 (ch 2)	Turns ON when abnormality occurs in serial communication using ch 2 (in the FX3U and FX3UC).	—	M, L	R
M8183	Data transfer sequence error	Turns ON when a data transfer sequence error occurs in the master station.	—	L	R
M8184 to M8190	Data transfer sequence error	Turns ON when a data transfer sequence error occurs in a slave station. However, data transfer sequence errors in itself (this slave station) cannot be detected.	—	M, L	R
M8191	Data transfer sequence ON	Remains ON while data transfer is being executed.	—	M, L	R

R : For reading only (used as a contact in program)

W/R : For setting and reading

M : Master station (station No. 0)

L : Slave station (station No. 1 to 7)

A	Common Items
B	N:N Network
C	Parallel Link
D	Computer Link
E	Inverter Communication
F	Non-Protocol Communication (RS/RS2 Instruction)
G	Non-Protocol Communication (FX2N-232IF)
H	Programming Communication
I	Remote Maintenance

	Master station	Slave station No. 1	Slave station No. 2	Slave station No. 3	Slave station No. 4	Slave station No. 5	Slave station No. 6	Slave station No. 7
	✓	✓	✓	✓	✓	✓	✓	✓
	✓	✓	✓	✓	✓	✓	✓	✓
	✓	✓	✓	✓	✓	✓	✓	✓
	✓	✓	✓	✓	✓	✓	✓	✓
	—	✓	✓	✓	✓	✓	✓	✓
	✓	M8184	M8185	M8186	M8187	M8188	M8189	M8190
	✓	✓	✓	✓	✓	✓	✓	✓

2. Word devices (data registers)

Device number	Name	Description	Initial value	Detection	R/W	
Devices for checking						
D8173	Corresponding station number settings status	Provided to check the station number.	—	M, L	R	
D8174	Slave station quantity setting status	Provided to check the number of slave stations.	—	M, L	R	
D8175	Refresh range setting status	Provided to check the refresh range.	—	M, L	R	
D8063	Serial communication error code 1 (ch 1)	Stores the serial communication error code for ch. 1 (in the FX3U and FX3UC).	—	M, L	R	
D8438	Serial communication error code 2 (ch 2)	Stores the serial communication error code for ch. 2 (in the FX3U and FX3UC).	—	M, L	R	
Devices for communication setting						
D8176	Corresponding station number settings	Provided to set the station number.	0	M, L	W/R	
D8177	Slave station quantity setting	Provided to set the number of slave stations used in communication.	7	M	W/R	
D8178	Refresh range setting	Provided to set the refresh range.	0	M	W/R	
D8179	Number of retries	Provided to set the number of retry times.	3	M	W/R	
D8180	Monitoring time	Provided to set the no-response monitoring time.	5	M	W/R	
Devices for checking communication status						
D8201	Present link scan time	Current value of the network cycle time	—	M	R	
D8202	Maximum link scan time	Maximum value of the network cycle time	—	M	R	
D8203	Data transfer sequence error count	Amount of data sequence errors that occurred in the master station	—	L	R	
D8204 to D8210	Data transfer sequence error count	Amount of data sequence errors that occurred in a slave station. However, data sequence errors occurring in itself (the slave station) cannot be counted.	—	M, L	R	
D8211	Data transmission error code	Stores the error code for the master station.	—	L	R	
D8212 to D8218	Data transmission error code	Stores the error code for a slave station. However, data sequence errors occurring in itself (the slave station) cannot be counted.	—	M, L	R	

R : For reading only (used as a contact in program)

W/R : For setting and reading

M : Master station (station No. 0)

L : Slave station (station No. 1 to 7)

A	Common Items
B	N:N Network
C	Parallel Link
D	Computer Link
E	Inverter Communication
F	Non-Protocol Communication (RS/RS2 Instruction)
G	Non-Protocol Communication (FX2N-232IF)
H	Programming Communication
I	Remote Maintenance

	Master station	Slave station No. 1	Slave station No. 2	Slave station No. 3	Slave station No. 4	Slave station No. 5	Slave station No. 6	Slave station No. 7
	✓	✓	✓	✓	✓	✓	✓	✓
	✓	✓	✓	✓	✓	✓	✓	✓
	✓	✓	✓	✓	✓	✓	✓	✓
	✓	✓	✓	✓	✓	✓	✓	✓
	✓	✓	✓	✓	✓	✓	✓	✓
	✓	✓	✓	✓	✓	✓	✓	✓
	✓	—	—	—	—	—	—	—
	✓	—	—	—	—	—	—	—
	✓	—	—	—	—	—	—	—
	✓	—	—	—	—	—	—	—
	✓	—	—	—	—	—	—	—
	—	✓	✓	✓	✓	✓	✓	✓
	✓	D8204	D8205	D8206	D8207	D8208	D8209	D8210
	✓	—	—	—	—	—	—	—
	✓	D8212	D8213	D8214	D8215	D8216	D8217	D8218

10.1.2 For FX1s and FX0N PLCs

1. Bit devices

Device number	Name	Description	Initial value	Detection	R/W
Devices for communication setting					
M8038	Parameter setting	Communication parameter setting flag	—	M, L	R
Devices for checking communication status					
M504	Data transfer sequence error	Turns ON when a data transfer sequence error occurs in the master station.	—	L	R
M505 to M511	Data transfer sequence error	Turns ON when a data transfer sequence error occurs in a slave station. However, data transfer sequence errors in itself (the slave station) cannot be detected.	—	M, L	R
M503	Data transfer sequence ON	Remains ON while data transfer is being executed.	—	M, L	R

R: For reading only (used as a contact in program)
 M: Master station (station No. 0) L: Slave station (station No. 1 to 7)

2. Word devices (data registers)

Device number	Name	Description	Initial value	Detection	R/W
Devices for checking					
D8173	Corresponding station number settings status	Provided to check the station number.	—	M, L	R
D8174	Slave station quantity setting status	Provided to check the number of slave stations.	—	M, L	R
D8175	Refresh range setting status	Provided to check the refresh range.	—	M, L	R
Devices for communication setting					
D8176	Corresponding station number settings	Provided to set the station number.	0	M, L	W/R
D8177	Slave station quantity setting	Provided to set the number of slave stations used in communication.	7	M	W/R
D8178	Refresh range setting	Provided to set the refresh range.	0	M	W/R
D8179	Number of retries	Provided to set the number of retries.	3	M	W/R
D8180	Monitoring time	Provided to set the no-response monitoring time.	5	M	W/R
Devices for checking communication status					
D201	Present link scan time	Stores the current value of the network cycle time.	—	M	R
D202	Maximum link scan time	Stores the maximum value of the network cycle time.	—	M	R
D203	Data transfer sequence error count	Stores the amount of data sequence errors that occurred in the master station.	—	L	R
D204 to D210	Data transfer sequence error count	Amount of data sequence errors that occurred in a slave station. However, data sequence errors that occurred in itself (the slave station) cannot be counted.	—	M, L	R
D211	Data transmission error code	Stores the error code for the master station.	—	L	R
D212 to D218	Data transmission error code	Stores the error code for a slave station. However, data sequence errors that occurred in itself (the slave station) cannot be counted.	—	M, L	R
D219 to D255	Not applicable	Provided for the internal processing.	—	—	—

R: For reading only (used as a contact in program) W/R: For setting and reading
 M: Master station (station No. 0) L: Slave station (station No. 1 to 7)

A	Common Items
B	N:N Network
C	Parallel Link
D	Computer Link
E	Inverter Communication
F	Non-Protocol Communication (RS/RS2 Instruction)
G	Non-Protocol Communication (FX2N-232IF)
H	Programming Communication
I	Remote Maintenance

	Master station	Slave station No. 1	Slave station No. 2	Slave station No. 3	Slave station No. 4	Slave station No. 5	Slave station No. 6	Slave station No. 7
	✓	✓	✓	✓	✓	✓	✓	✓
	—	✓	✓	✓	✓	✓	✓	✓
	✓	M505	M506	M507	M508	M509	M510	M511
	✓	✓	✓	✓	✓	✓	✓	✓

	Master station	Slave station No. 1	Slave station No. 2	Slave station No. 3	Slave station No. 4	Slave station No. 5	Slave station No. 6	Slave station No. 7
	✓	✓	✓	✓	✓	✓	✓	✓
	✓	✓	✓	✓	✓	✓	✓	✓
	✓	✓	✓	✓	✓	✓	✓	✓
	✓	—	—	—	—	—	—	—
	✓	—	—	—	—	—	—	—
	✓	—	—	—	—	—	—	—
	✓	—	—	—	—	—	—	—
	—	✓	✓	✓	✓	✓	✓	✓
	✓	D204	D205	D206	D207	D208	D209	D210
	✓	—	—	—	—	—	—	—
	✓	D212	D213	D214	D215	D216	D217	D218
	—	—	—	—	—	—	—	—

10.2 Details of Related Devices

The devices described below are used in the N:N Network.

10.2.1 Parameter setting [M8038]

This device works as the communication parameter setting flag.

1. Stations requiring program setting

Setting is required in the master station and slave stations.

2. Detailed contents

"LD M8038" provided in the step 0 starts the parameter setting, and the last instruction in this circuit block finishes the setting.

(This sequence program is not executed as user program in every scan.)

3. Cautions on use

Do not set this device to ON using a program or programming tool.

10.2.2 Channel setting [M8179]

This device works as the channel setting flag (in the FX3U and FX3UC).

1. Stations requiring program setting

Setting is required in the master station and slave stations.

2. Detailed contents

When the communication port to be used is ch 2, set this device to ON in a sequence program.

When using ch 1, the sequence program is not required.

10.2.3 Serial communication error [M8063 and M8438]

These devices turn ON when an error is included in the parameters used to set the N:N Network. (M8438 is available in the FX3U and FX3UC.)

1. Stations requiring program setting

Setting is required in the master station and slave stations to check the communication status.

2. Detailed contents

M8063 turns ON when an error is included in the parameters used to set N:N Network using ch 1.

M8438 turns ON when an error is included in the parameters used to set N:N Network using ch 2.

3. Cautions on use

Do not set these devices to ON using a program or programming tool.

10.2.4 Data transfer sequence error [M8138 to M8190] [M504 to M511]

These devices turn ON when a data transfer sequence error occurs in the master station or a slave station.

1. Stations requiring program setting

Setting is required in the master station and slave stations.
However, setting for each station itself is not required.

2. Detailed contents

A used device varies depending on the FX Series.

FX Series	Master station	Slave station No. 1	Slave station No. 2	Slave station No. 3	Slave station No. 4	Slave station No. 5	Slave station No. 6	Slave station No. 7
FX1N, FX2N, FX3U, FX1NC, FX2NC, FX3UC	M8183	M8184	M8185	M8186	M8187	M8188	M8189	M8190
FX0N, FX1S	M504	M505	M506	M507	M508	M509	M510	M511

3. Cautions on use

Data transfer sequence errors in a station itself cannot be detected.
Do not set these devices to ON using a program or programming tool.

10.2.5 Data transfer sequence ON [M8191] [M503]

This device remains ON while data transfer is being executed in the master station or slave station.

1. Stations requiring program setting

Setting is required in the master station and slave stations.

2. Detailed contents

A used device varies depending on the FX Series.

FX Series	Data transfer sequence ON
FX1N, FX2N, FX3U, FX1NC, FX2NC, FX3UC	M8191
FX0N, FX1S	M503

3. Cautions on use

Do not set this device to ON using a program or programming tool.

10.2.6 Serial communication error code [D8063 and D8438]

These devices store the serial communication error code (in the FX3U and FX3UC).

1. Stations requiring program setting

Setting is required in the master station and slave stations to check the error code.

2. Detailed contents

The error code of a serial communication error that occurred in ch 1 is stored in D8063.
If an error is included in the parameters used for the N:N Network, "6308" is stored.
The error code of a serial communication error that occurred in ch 2 is stored in D8438.
If an error is included in the parameters used for the N:N Network, "3808" is stored.

3. Cautions on use

Serial communication errors are not cleared even after the communication has recovered to the normal status. For clearing them, change the PLC mode from STOP to RUN.

10.2.7 Corresponding station number settings status [D8173]

This device is used to check the station number settings status in itself.

1. Stations requiring program setting

Setting is required in the master station and slave stations to check the setting status.

2. Detailed contents

The contents stored in the corresponding station number settings device D8176 are stored in D8173.

3. Cautions on use

Do not change a preset numeric value using a program or programming tool.

10.2.8 Slave station quantity setting status [D8174]

Use this device to check the number of slave stations set in the master station.

1. Stations requiring program setting

Setting is required in the master station and slave stations to check the setting status.

2. Detailed contents

The contents stored in the slave station quantity setting device D8177 in the master station are stored in D8174.

3. Cautions on use

Do not change a preset numeric value using a program or programming tool.

10.2.9 Refresh range setting status [D8175]

Use this device to check the refresh range set in the master station.

1. Stations requiring program setting

To check the setting status, the master and slave stations require program setting.

2. Detailed contents

The contents stored in the refresh range setting device D8178 in the master station are stored in D8175.

3. Cautions on use

Do not change a preset numeric value using a program or programming tool.

10.2.10 Station number settings [D8176]

Set a value in the range from 0 to 7 to the special data register D8176 (initial value: 0).

1. Stations requiring program setting

The master and stations require program setting.

2. Detailed contents

Set value	Description
0	Master station
1 to 7	Slave station number Examples: "1" → Station No. 1, "5" → Station No. 5

10.2.11 Slave station quantity setting [D8177]

Set a value in the range from 1 to 7 to the special data register D8177 (initial value: 7).

1. Stations requiring program setting

The master station requires program setting, and slave stations don't require program setting.

2. Detailed contents

Set value	Description	Set value	Description
0	Not applicable	4	Four slave stations are connected.
1	One slave station is connected.	5	Five slave stations are connected.
2	Two slave stations are connected.	6	Six slave stations are connected.
3	Three slave stations are connected.	7	Seven slave stations are connected.

10.2.12 Refresh range setting [D8178]

Set a value in the range from 0 to 2 to the special data register D8178 (initial value: 0).

1. Stations requiring program setting

The master station requires program setting, and slave stations don't require program setting.

2. Pattern applicability in FX PLC

Pattern (set value)	Pattern 0 (0)	Pattern 1 (1)	Pattern 2 (2)
FX0N PLC	✓	Not applicable	Not applicable
FX1S PLC	✓	Not applicable	Not applicable
FX1N PLC	✓	✓	✓
FX2N PLC	✓	✓	✓
FX3U PLC	✓	✓	✓
FX1NC PLC	✓	✓	✓
FX2NC PLC	✓	✓	✓
FX3UC PLC	✓	✓	✓

3. Number and assignment of link devices

The number of link devices varies depending on the selected pattern, but the head device number is equivalent.

It is recommended to leave unused numbers in the unused status to enable pattern change in the future.

Station No.	Pattern 0		Pattern 1		Pattern 2	
	Bit device (M)	Word device (D)	Bit device (M)	Word device (D)	Bit device (M)	Word device (D)
	0	4 in each station	32 in each station	4 in each station	64 in each station	8 in each station
0	—	D 0 to D 3	M1000 to M1031	D 0 to D 3	M1000 to M1063	D 0 to D 7
1	—	D10 to D13	M1064 to M1095	D10 to D13	M1064 to M1127	D10 to D17
2	—	D20 to D23	M1128 to M1159	D20 to D23	M1128 to M1191	D20 to D27
3	—	D30 to D33	M1192 to M1223	D30 to D33	M1192 to M1255	D30 to D37
4	—	D40 to D43	M1256 to M1287	D40 to D43	M1256 to M1319	D40 to D47
5	—	D50 to D53	M1320 to M1351	D50 to D53	M1320 to M1383	D50 to D57
6	—	D60 to D63	M1384 to M1415	D60 to D63	M1384 to M1447	D60 to D67
7	—	D70 to D73	M1448 to M1479	D70 to D73	M1448 to M1511	D70 to D77

4. Cautions on use

- 1) Cautions on using FX1S and FX0N PLCs
 When FX1S and/or FX0N PLCs are included in the system, make sure to set the refresh range to the pattern 0.
 If any other pattern is selected, data transfer error will occur in all FX1S and FX0N PLCs included in the system, and the link time will become longer.
- 2) Occupied devices
 The devices used in each pattern are occupied for the N:N Network in all stations.
 Make sure that such devices are not used in general programs.

10.2.13 Number of retries [D8179]

Set a value in the range from 0 to 10 to the special data register D8179 (initial value: 3).

1. Stations requiring program setting

The master station requires program setting, and slave stations don't require program setting.

2. Detailed contents

When any response is not given after retry by the specified number of times, the station not giving response is regarded as data transfer sequence error by other stations.

10.2.14 Monitoring time setting [D8180]

Set a value in the range from 5 to 255 to the special data register D8180 in units of "10 ms" (initial value: 5 [50 ms]).

1. Stations requiring program setting

The master station requires program setting, and slave stations don't require program setting.

2. Detailed contents

If data transfer between the master station and a slave station requires time longer than the monitoring time set here, the master station or slave station is regarded as abnormal.

10.2.15 Present link scan time [D8201] [D201]

This device stores the current value of the network cycle in the N:N Network (unit: 0.1 ms).

1. Stations requiring program setting

The master station requires program setting.

2. Detailed contents

A used device varies depending on the FX Series.

FX Series	Data transfer sequence ON
FX1N, FX2N, FX3U, FX1NC, FX2NC, FX3UC	D8201
FX0N, FX1S	D201

3. Cautions on use

Do not change a preset numeric value using a program or programming tool.

10.2.16 Maximum link scan time [D8202] [D202]

This device stores the maximum value of the network cycle in the N:N Network (unit: 0.1 ms).

1. Stations requiring program setting

The master station requires program setting.

2. Detailed contents

A used device varies depending on the FX Series.

FX Series	Data transfer sequence ON
FX1N, FX2N, FX3U, FX1NC, FX2NC, FX3UC	D8202
FX0N, FX1S	D202

3. Cautions on use

Do not change a preset numeric value using a program or programming tool.

10.2.17 Data transfer sequence error count [D8203 to D8210] [D203 to D210]

These devices store the amount of data transfer sequence errors that occurred in the master station and slave stations.

1. Stations requiring program setting

The master and slave stations require program setting.
However, setting for each station itself is not required.

2. Detailed contents

A used device varies depending on the FX Series.

FX Series	Master station	Slave station No. 1	Slave station No. 2	Slave station No. 3	Slave station No. 4	Slave station No. 5	Slave station No. 6	Slave station No. 7
FX1N, FX2N, FX3U, FX1NC, FX2NC, FX3UC	D8203	D8204	D8205	D8206	D8207	D8208	D8209	D8210
FX0N, FX1S	D203	D204	D205	D206	D207	D208	D209	D210

3. Cautions on use

Data transfer sequence errors that occurred in itself cannot be detected.
Do not change a preset numeric value using a program or programming tool.

10.2.18 Data transfer error code [D8211 to D8218] [D211 to D218]

These devices store the error code in the master station and slave stations.

1. Stations requiring program setting

The master station requires program setting.
However, this setting is not required for itself.

A	Common Items
B	N:N Network
C	Parallel Link
D	Computer Link
E	Inverter Communication
F	Non-Protocol Communication (RS/RS2 Instruction)
G	Non-Protocol Communication (FX2N-232IF)
H	Programming Communication
I	Remote Maintenance

2. Detailed contents

1) Used devices vary depending on the FX Series.

FX Series	Master station	Slave station No. 1	Slave station No. 2	Slave station No. 3	Slave station No. 4	Slave station No. 5	Slave station No. 6	Slave station No. 7
FX1N, FX2N, FX3U, FX1NC, FX2NC, FX3UC	D8211	D8212	D8213	D8214	D8215	D8216	D8217	D8218
FX0N, FX1S	D211	D212	D213	D214	D215	D216	D217	D218

2) Error code list

Error code	Error name	Station in which error occurred	Station which detected error	Contents of error	Check point
01H	Monitoring timeout	L	M	Slave station did not give any response to the sending request given by the master station within the monitoring timer time.	Wiring and power supply
02H	Station number error	L	M	To the sending request given by the master station, an unspecified slave station gave response.	Wiring
03H	Counter error	L	M	The counter value included in the parameter data is different from the counter value given by a slave station.	Wiring
04H	Message format error	L	M, L	The message given by a slave station is incorrect.	Wiring, power supply and station number settings
11H	Monitoring timeout	M	L	The master station did not give sending request to the next slave station within the monitoring timer.	Wiring and power supply
14H	Message format error	M	L	The message from the master station is incorrect.	Wiring, power supply and station number settings
21H	Slave station no response error	L	L ^{*1}	The specified slave station does not exist.	Wiring, power supply and station number settings
22H	Station number error	L	L ^{*1}	To the sending request given by the master station, an unspecified slave station gave response.	Wiring
23H	Counter error	L	L ^{*1}	The counter value included in the parameter data is different from the counter value given by a slave station.	Wiring
31H	Parameter not received	L	L ^{*2}	Before parameters had been received, sending request given by the master station was received.	Wiring and power supply

M: Master station, L: Slave station

- *1. Any slave station other than the slave station in which error occurred
- *2. Station in which error occurred

3. Cautions on use

Data transfer sequence errors that occurred in itself cannot be detected.
 Do not change a preset numeric value using a program or programming tool.

FX Series Programmable Controllers

User's Manual [Parallel Link]

Foreword

This manual explains "parallel link" provided in MELSEC-F FX Series Programmable Controllers and should be read and understood before attempting to install or use the unit. Store this manual in a safe place so that you can take it out and read it whenever necessary. Always forward it to the end user.

This manual confers no industrial property rights or any rights of any other kind, nor does it confer any patent licenses. Mitsubishi Electric Corporation cannot be held responsible for any problems involving industrial property rights which may occur as a result of using the contents noted in this manual.

© 2005 MITSUBISHI ELECTRIC CORPORATION

A

Common Items

B

N:N Network

C

Parallel Link

D

Computer Link

E

Inverter
Communication

F

Non-Protocol
Communication
(RS/RS2 Instruction)

G

Non-Protocol
Communication
(FX2N-232IF)

H

Programming
Communication

I

Remote
Maintenance

1. Outline

This chapter explains the outline of the parallel link.

1.1 Outline of System

The parallel link allows connection of two FX PLCs in the same series to mutually link devices.

- 1) According to the number of devices to be linked, either pattern can be selected between the regular mode and the high speed mode.
- 2) Data link is automatically updated between up to two FX PLCs.
- 3) The total extension distance is 500 m (1640' 5") maximum (when only the 485ADP is adopted) (except when FX2(FX)/FX2C PLCs and/or 485BD is adopted).

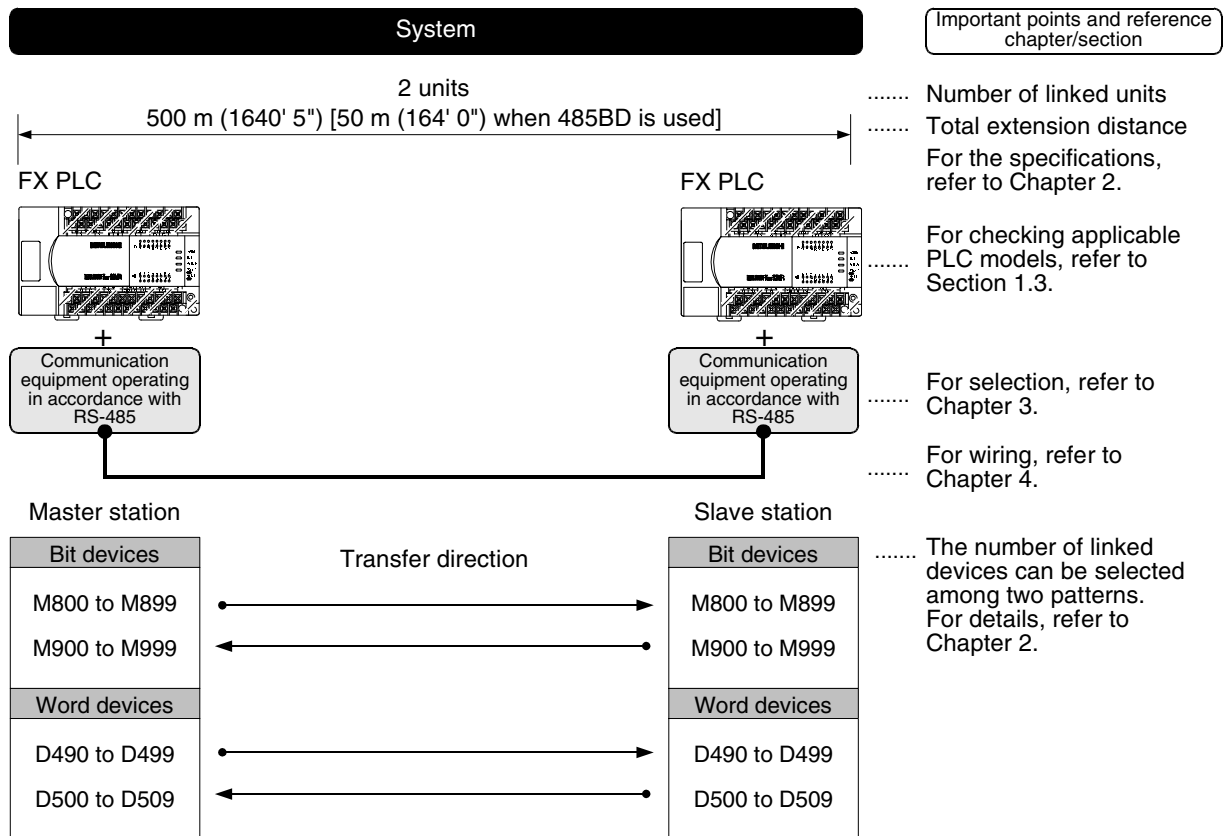

The figure above shows the maximum number of linked devices. There are differences in the specifications and limitation depending on the selected link pattern and FX Series.

A	Common Items
B	N:N Network
C	Parallel Link
D	Computer Link
E	Inverter Communication
F	Non-Protocol Communication (RS/RS2 Instruction)
G	Non-Protocol Communication (FX2N-232IF)
H	Programming Communication
I	Remote Maintenance

1.2 Major Procedures until Operation

The flow chart below shows the procedures for setting the parallel link until data link:

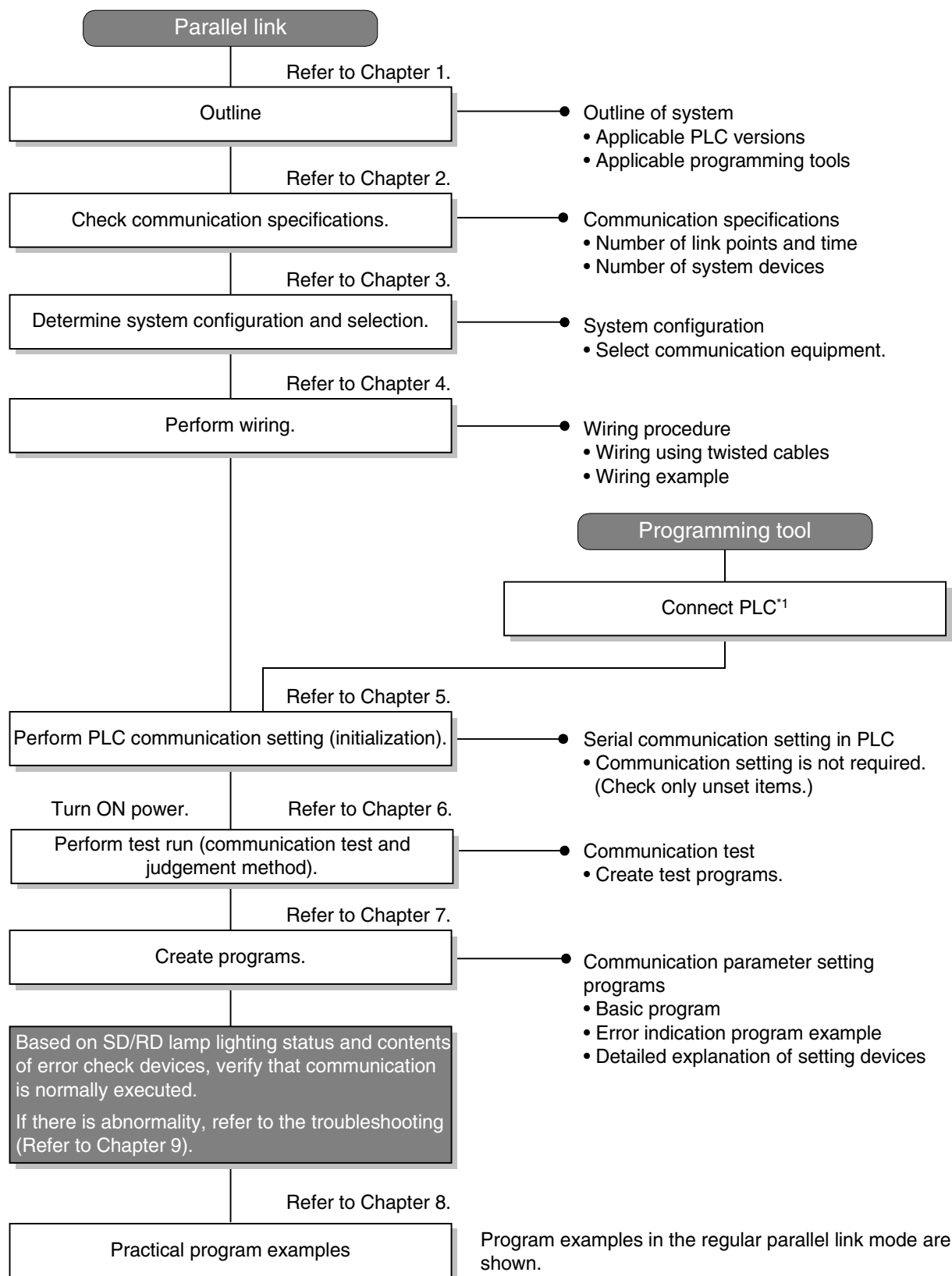

*1 For the method to connect a programming tool to a PLC, refer to the section "Programming Communication" in this manual or the manual of each programming tool.
For details on operating procedures, refer to the manual of each programming tool.

1.3 Communication Type Applicability in PLC

1.3.1 Applicable versions

The communication types are applicable in the following versions.

✓: Applicable (If applicable versions are limited, they are described inside ().) —: Not applicable

PLC	Applicability (applicable version)	Remarks
FX3UC Series	✓	
FX3U Series	✓	
FX2NC Series	✓	
FX2N Series	✓ (Ver. 1.04 or later)	
FX1NC Series	✓	
FX1N Series	✓	
FX1S Series	✓	The link device range is limited.
FX0N Series	✓ (Ver. 1.20 or later)	The link device range is limited.
FX0S Series	—	N:N Network is not provided.
FX0 Series	—	N:N Network is not provided.
FX2C Series	✓	The high speed link mode is supported in Ver. 3.07 and later.
FX2(FX) Series	✓	The high speed link mode is supported in Ver. 3.07 and later.
FX1 Series	—	N:N Network is not provided.

1. Version check

The D8001(decimal) special data register contains information for determining the PLC version.

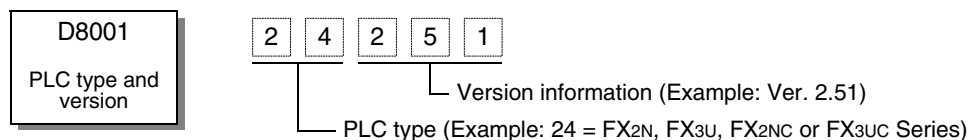

1.3.2 Products whose production was stopped

The table below shows series in which production of the main unit, communication equipment, etc. is stopped.

Use the description on system configuration, etc. in this manual for maintenance.

PLC	Date when production was stopped	Remarks
FX0 Series	June 30, 2002	Maintenance is offered within 7 years from the end of production (until June 30, 2009).
FX2C Series		
FX2(FX) Series		
FX1 Series		

A
Common Items

B
N:N Network

C
Parallel Link

D
Computer Link

E
Inverter Communication

F
Non-Protocol Communication (RS/RS2 Instruction)

G
Non-Protocol Communication (FX2N-232IF)

H
Programming Communication

I
Remote Maintenance

1.4 Programming Tool Applicability

1.4.1 For applicable versions

The programming tool is applicable in each FX Series from the following version:

1. Japanese versions

✓: Applicable (If applicable versions are limited, they are described inside ().) —: Not applicable

Model name (Media model name is shown below.)	Applicability (applicable version)	Remarks
FX3u and FX3UC PLCs		
GX Developer SW□D5C(F)-GPPW-J	✓ (Ver. SW8 P or later) Ver.8.13P	Select the model "FX3UC".
FX2N and FX2NC PLCs		
GX Developer SW□D5C(F)-GPPW-J	✓ (Ver. SW2 A or later)	Select the model "FX2N/FX2NC".
FX-PCS/WIN SW0PC-FXGP/WIN	✓ (Ver. 2.00 or later)	
FX-PCS-KIT/98 SW1PC-FXGP/98(-3,-5)	✓ (Ver. 4.00 or later)	
FX-PCS/98-3 SW1PC-FXGP/98-3	✓ (Ver. 4.00 or later)	
FX-PCS-KIT/V-3 SW1-PC-FXGP/V3	✓ (Ver. 2.00 or later)	
FX-A7PHP-KIT SW1RX-GPPFX	✓ (Ver. 3.00 or later)	
FX-20P(-SET0) FX-20P-MFXC	✓ (Ver. 4.00 or later)	
FX-10P(-SET0)	✓ (Ver. 3.00 or later)	
GOT-F900 Series display units F940WGOT-TWD F940GOT-*WD F940GOT-*BD-H F940GOT-*BD-RH	✓ (Refer to right column.)	F940WGOT-TWD (Ver. 1.00 or later) F940GOT-LWD, F940GOT-SWD (Ver. 1.00 or later) F940GOT-LBD-H, F940GOT-SBD-H (Ver. 1.00 or later) F940GOT-LBD-RH, F940GOT-SBD-RH (Ver. 1.00 or later)
FX1S, FX1N and FX1NC PLCs		
GX Developer SW□D5C(F)-GPPW-J	✓ (Ver. SW5 A or later)	Select the model "FX1S/FX1N".
FX-PCS/WIN SW0PC-FXGP/WIN	✓ (Ver. 4.00 or later)	
FX-PCS/98-3 SW1PC-FXGP/98-3	✓ (Ver. 5.00 or later)	
FX-20P(-SET0) FX-20P-MFXD	✓ (Ver. 5.00 or later)	
FX-10P(-SET0)	✓ (Ver. 4.00 or later)	
GOT-F900 Series display units F940WGOT-TWD F940GOT-*WD F940GOT-*BD-H F940GOT-*BD-RH	✓ (Refer to right column.)	F940WGOT-TWD (Ver. 1.00 or later) F940GOT-LWD, F940GOT-SWD (Ver. 1.00 or later) F940GOT-LBD-H, F940GOT-SBD-H (Ver. 1.00 or later) F940GOT-LBD-RH, F940GOT-SBD-RH (Ver. 1.00 or later)

2. English versions

✓: Applicable (If applicable versions are limited, they are described inside ().) —: Not applicable

Model name (Media model name is shown below.)	Applicability (applicable version)	Remarks
FX3u and FX3uc PLCs		
GX Developer SW□D5C(F)-GPPW-E	✓ (Ver. SW8 P or later) Ver.8.13P	Select the model "FX3UC".
FX2N and FX2NC PLCs		
GX Developer SW□D5C(F)-GPPW-E	✓ (Ver. SW2 A or later)	Select the model "FX2N/FX2NC".
FX-PCS/WIN-E SW0PC-FXGP/WIN-E	✓ (Ver. 1.00 or later)	
FX-20P-E(-SET0) FX-20P-MFXC-E	✓ (Ver. 3.00 or later)	
FX-10P-E	✓ (Ver. 3.00 or later)	
GOT-F900 Series display units F940WGOT-TWD-E F940GOT-*WD-E F940GOT-*BD-H-E F940GOT-*BD-RH-E	✓ (Refer to right column.)	F940WGOT-TWD-E (Ver. 1.00 or later) F940GOT-LWD-E, F940GOT-SWD-E (Ver. 1.00 or later) F940GOT-LBD-H-E, F940GOT-SBD-H-E (Ver. 1.00 or later) F940GOT-LBD-RH-E, F940GOT-SBD-RH-E (Ver. 1.00 or later)
FX1S, FX1N and FX1NC PLCs		
GX Developer SW□D5C(F)-GPPW-E	✓ (Ver. SW5 A or later)	Select the model "FX1S/FX1N".
FX-PCS/WIN-E SW0PC-FXGP/WIN-E	✓ (Ver. 3.00 or later)	
FX-20P-E(-SET0) FX-20P-MFXD-E	✓ (Ver. 4.00 or later)	
FX-10P-E	✓ (Ver. 4.00 or later)	
GOT-F900 Series display units F940WGOT-TWD-E F940GOT-*WD-E F940GOT-*BD-H-E F940GOT-*BD-RH-E	✓ (Refer to right column.)	F940WGOT-TWD-E (Ver. 1.00 or later) F940GOT-LWD-E, F940GOT-SWD-E (Ver. 1.00 or later) F940GOT-LBD-H-E, F940GOT-SBD-H-E (Ver. 1.00 or later) F940GOT-LBD-RH-E, F940GOT-SBD-RH-E (Ver. 1.00 or later)

A

Common Items

B

N:N Network

C

Parallel Link

D

Computer Link

E

Inverter Communication

F

Non-Protocol Communication (RS/RS2 Instruction)

G

Non-Protocol Communication (FX2N-232IF)

H

Programming Communication

I

Remote Maintenance

1.4.2 For non-applicable versions (setting an alternative model)

Even software not applicable in a PLC can make programs when an alternative model is set. In this case, however, programming is enabled only in the function ranges such as instructions and program size provided in a PLC selected as the alternative model.

Model to be programmed	Model to be set	Priority: High → Low			
		→		→	
FX3UC Series	FX3UC	→	FX2N	→	FX2(FX)
FX3U Series	FX3UC, FX3U	→	FX2N	→	FX2(FX)
FX2NC Series	FX2NC, FX2N	→	FX2(FX)		
FX2N Series	FX2N	→	FX2(FX)		
FX1NC Series	FX1NC, FX1N	→	FX2N	→	FX2(FX)
FX1N Series	FX1N	→	FX2N	→	FX2(FX)
FX1S Series	FX1S	→	FX2(FX)		
FX0N Series	FX0N	→	FX2(FX)		
FX0S Series	FX0S	→	FX2(FX)		
FX0 Series	FX0	→	FX2(FX)		
FX2C Series	FX2C, FX2(FX)	→	FX2(FX)		
FX2(FX) Series	FX2(FX)	→	FX2(FX)		
FX1 Series	FX1				

2. Specifications

This chapter explains the communication specifications and performance of the parallel link.

2.1 Communication Specifications (Reference)

The parallel link is executed using the (fixed) communication specifications shown in the table below. Any specification item such as baud rate cannot be changed.

Item	Specifications	Remarks
Number of connectable units	2 maximum (1:1)	
Transmission standard	RS-485 or RS-422 standard	
Maximum total extension distance	500 m (1640' 5") or less [50 m (164' 0") or less when 485BD is included in system]	
FX3UC Series		
FX3U Series		
FX2NC Series		
FX2N Series		
FX1NC Series		
FX1N Series		
FX1S Series		
FX0N Series		
FX2C Series	Wire link: 10 m (32' 9") or less	Wire link: FX2-40AW
FX2(FX) Series	Optical fiber: 50 m (164' 0") or less	Optical fiber: FX2-40AP
Protocol type	Parallel link	
Control procedure	—	
Communication method	Half-duplex, bidirectional communication	
Baud rate	Fixed	
Character format	Fixed	
Start bit		
Data bit		
Parity bit		
Stop bit		
Header	Fixed	
Terminator		
Control line	—	
Sum check	Fixed	

A	Common Items
B	N:N Network
C	Parallel Link
D	Computer Link
E	Inverter Communication
F	Non-Protocol Communication (RS/RS2 Instruction)
G	Non-Protocol Communication (FX2N-232IF)
H	Programming Communication
I	Remote Maintenance

2.2 Link Specifications

2.2.1 PLC communication type applicability status

✓: Applicable (If applicable versions are limited, they are described inside ().) —: Not applicable

PLC	Regular parallel link mode applicability (applicable version)	High speed parallel link mode applicability (applicable version)
FX3UC Series	✓	✓
FX3U Series	✓	✓
FX2NC Series	✓	✓
FX2N Series	✓ (Ver. 1.04 or later)	✓ (Ver. 1.04 or later)
FX1NC Series	✓	✓
FX1N Series	✓	✓
FX1S Series	✓	✓
FX0N Series	✓ (Ver. 1.20 or later)	✓ (Ver. 1.20 or later)
FX0S Series	—	—
FX0 Series	—	—
FX2C Series	✓	✓ (Ver. 3.07 or later)
FX2(FX) Series	✓	✓ (Ver. 3.07 or later)

2.2.2 Link time

The link time indicates the cycle time in which link devices are updated.
The link time varies depending on the link mode as shown in the tables below.

1. For FX3U and FX3UC Series

Link mode	Time
Regular parallel link mode	15 ms + Master station operation cycle (ms) + Slave station operation cycle (ms)
High speed parallel link mode	5 ms + Master station operation cycle (ms) + Slave station operation cycle (ms)

2. For FX2(FX), FX2C, FX0N, FX1S, FX1N, FX2N, FX1NC and FX2NC Series

Link mode	Time
Regular parallel link mode	70 ms + Master station operation cycle (ms) + Slave station operation cycle (ms)
High speed parallel link mode	20 ms + Master station operation cycle (ms) + Slave station operation cycle (ms)

2.3 Link Device Numbers and Number of Points

2.3.1 For FX1S and FX0N Series

Mode	Regular parallel link mode		High speed parallel link mode	
	Bit device (M)	Word device (D)	Bit device (M)	Word device (D)
Type	50 in each station	10 in each station	0	2 in each station
Master station	M400 to M449	D230 to D239	—	D230, D231
Slave station	M450 to M499	D240 to D249	—	D240, D241

1. Regular parallel link mode

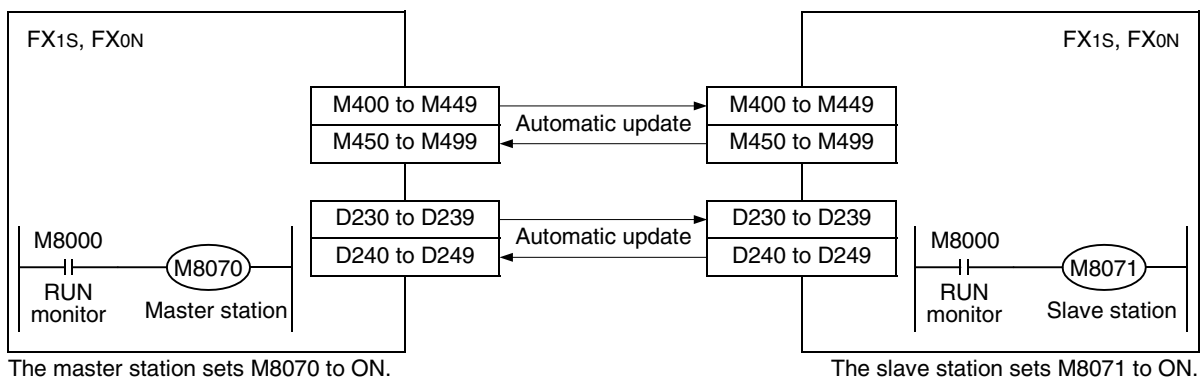

2. High speed parallel link mode

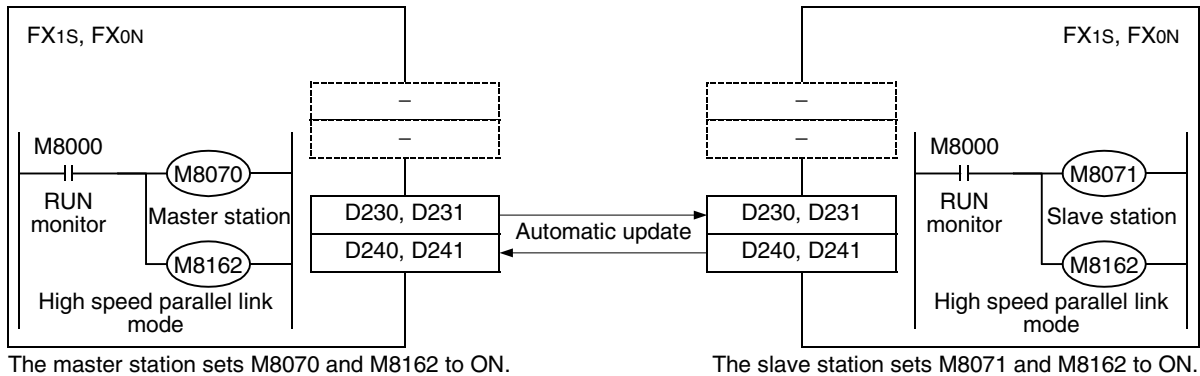

A
Common Items

B
N:N Network

C
Parallel Link

D
Computer Link

E
Inverter Communication

F
Non-Protocol Communication (RS/RS2 Instruction)

G
Non-Protocol Communication (FX2N-232IF)

H
Programming Communication

I
Remote Maintenance

2.3.2 For FX2(FX), FX2C, FX1N, FX2N, FX3U, FX1NC, FX2NC and FX3UC Series

Mode	Regular parallel link mode		High speed parallel link mode	
	Bit device (M)	Word device (D)	Bit device (M)	Word device (D)
Type	100 in each station	10 in each station	0	2 in each station
Master station	M800 to M899	D490 to D499	—	D490, D491
Slave station	M900 to M999	D500 to D509	—	D500, D501

1. Regular parallel link mode

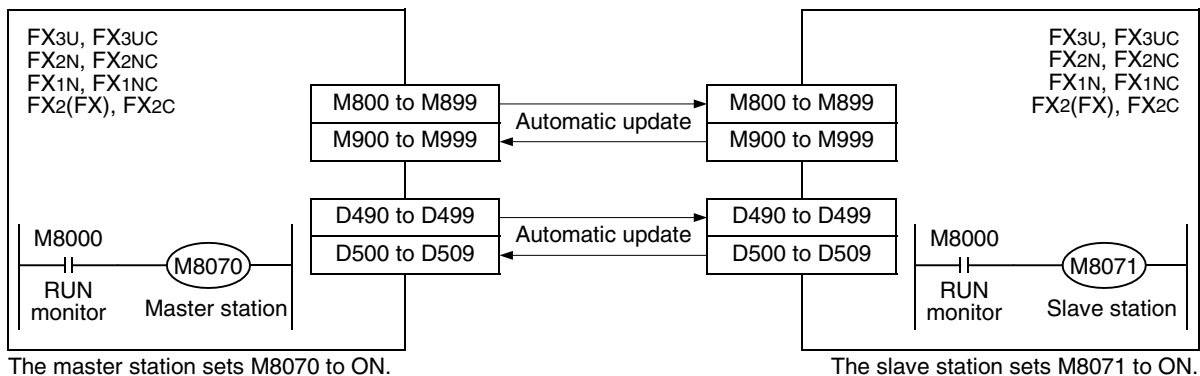

2. High speed parallel link mode

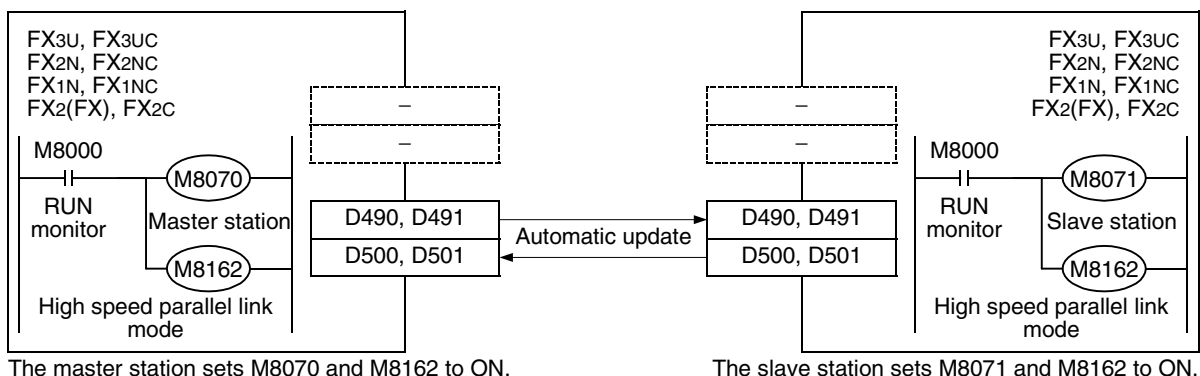

3. System Configuration and Selection

This chapter explains the configuration of communication equipment operating in accordance with RS-485 and selection of system required by FX PLCs.

3.1 System Configuration

This section explains the outline of system configuration required to use the parallel link. Add (optional) communication equipment operating in accordance with RS-485 to an FX PLC main unit.

3.1.1 Rule for connection

When using the parallel link, PLCs in the same group, as shown in the table below, can be connected.

Group	PLC Series
1	FX3U and FX3UC Series
2	FX2N and FX2NC Series
3	FX1N and FX1NC Series
4	FX1S Series
5	FX0N Series
6	FX2(FX) and FX2C Series

A

Common Items

B

N:N Network

C

Parallel Link

D

Computer Link

E

Inverter Communication

F

Non-Protocol Communication (RS/RS2 Instruction)

G

Non-Protocol Communication (FX2N-232IF)

H

Programming Communication

I

Remote Maintenance

3.2 Configuration of Each Group

1, 2 and 3 indicate the pattern types of combination of communication equipment.

1. Group 1 (FX3U and FX3UC Series)

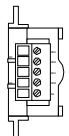
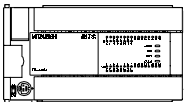
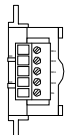
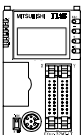
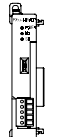
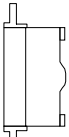
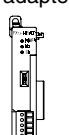
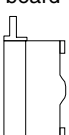
Communication equipment operating in accordance with RS-485		FX PLC	Important point in selection	Total extension distance
1	 Communication board	 FX3U Series	Because it can be built inside a PLC, the installation area is not changed.	50 m (164' 0")
	 Communication board	 FX3UC Series		
2	 Communication adapter	 Expansion board	Attach the expansion board to the main unit, and then attach the communication adapter on the left side of the main unit.	500 m (1640' 5")
	 Communication adapter	 Expansion board		

➔ For combinations of communication equipment for each FX Series, refer to the next section.

2. Group 2 (FX2N and FX2NC Series)

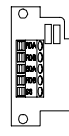
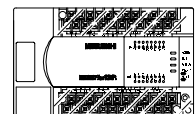
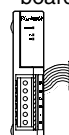
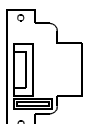
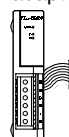
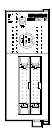
Communication equipment operating in accordance with RS-485		FX PLC	Important point in selection	Total extension distance
1	 Communication board	 FX2N Series	Because it can be built inside a PLC, the installation area is not changed.	50 m (164' 0")
2	 Communication adapter	 Special adapter connection board		
3	 Communication adapter	 FX2NC Series	Attach the communication adapter on the left side of the main unit.	500 m (1640' 5")

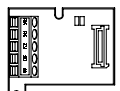
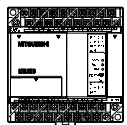
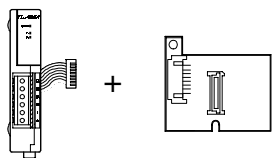
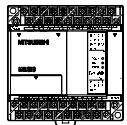
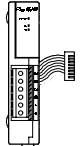
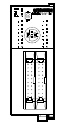

➔ For combinations of communication equipment for each FX Series, refer to the next section.

3. Group 3 (FX1N and FX1NC Series)

Communication equipment operating in accordance with RS-485	FX PLC	Important point in selection	Total extension distance
1  Communication board	 FX1N Series	Because it can be built inside a PLC, the installation area is not changed.	50 m (164' 0")
2  Communication adapter Special adapter connection board	 FX1N Series	Attach the special adapter connection board to the main unit, and then attach the communication adapter on the left side of the main unit.	500 m (1640' 5")
3  Communication adapter	 FX1NC Series	Attach the communication adapter on the left side of the main unit.	500 m (1640' 5")

➔ For combinations of communication equipment for each FX Series, refer to the next section.

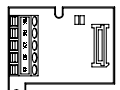
4. Group 4 (FX1S Series)

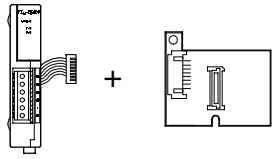
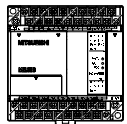
Communication equipment operating in accordance with RS-485	FX PLC	Important point in selection	Total extension distance
1  Communication board	 FX1S Series	Because it can be built inside a PLC, the installation area is not changed.	50 m (164' 0")
2  Communication adapter Special adapter connection board	 FX1S Series	Attach the special adapter connection board to the main unit, and then attach the communication adapter on the left side of the main unit.	500 m (1640' 5")

➔ For combinations of communication equipment for each FX Series, refer to the next section.

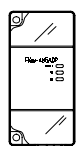
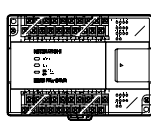

5. Group 5 (FX0N Series)

Communication equipment operating in accordance with RS-485	FX PLC	Important point in selection	Total extension distance
1  Communication adapter	 FX0N Series	Attach the communication adapter on the left side of the main unit.	500 m (1640' 5")

➔ For combinations of communication equipment for each FX Series, refer to the next section.

A	Common Items
B	N:N Network
C	Parallel Link
D	Computer Link
E	Inverter Communication
F	Non-Protocol Communication (RS/RS2 Instruction)
G	Non-Protocol Communication (FX2N-232IF)
H	Programming Communication
I	Remote Maintenance

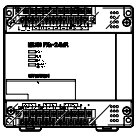
6. Group 6 (FX2(FX) and FX2c Series)

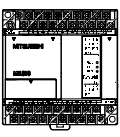

Communication equipment using optical fiber or in accordance with RS-485	FX PLC	Important point in selection	Total extension distance
<p>1</p>  <p>Communication adapter</p>	<p>+</p>  <p>FX2(FX)/FX2c Series</p>	<p>Attach the communication adapter on the left side of the main unit. Perform wiring using optical fiber cables.</p>	<p>50 m (164' 0")</p>
<p>2</p>  <p>Communication adapter</p>	<p>+</p>  <p>FX2(FX)/FX2c Series</p>	<p>Attach the communication adapter on the left side of the main unit. Perform wiring using twisted pair cables.</p>	<p>10 m (32' 9")</p>

➡ For combinations of communication equipment for each FX Series, refer to the next section.



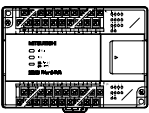

3.3 Applicable FX PLC and Communication Equipment

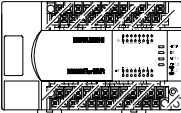

Select a combination of (optional) communication equipment, and put a check mark in the "Check" column. In selection, pay attention to the following:

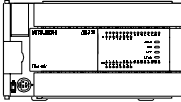
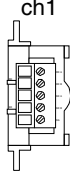
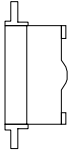
- In the table below, only the external dimensions are different between units of shown in "485ADP/485ADP". Select either one.
- The parallel link is not provided in the FX0, FX0s and FX1 Series.

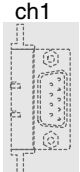
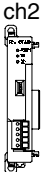
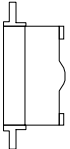

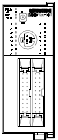
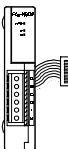
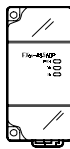
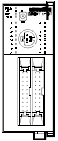
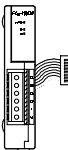
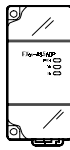

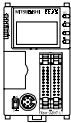
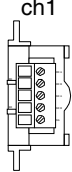
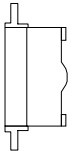
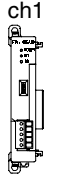
FX Series	Communication equipment (option)	Total extension distance	Check
 FX0N	 FX2NC-485ADP (European terminal block) / FX0N-485ADP (Terminal block)	500 m (1640' 5")	
 FX1s	 FX1N-485-BD (European terminal block)	50 m (164' 0")	
	 FX1N-CNV-BD + FX2NC-485ADP (European terminal block) / FX1N-CNV-BD + FX0N-485ADP (Terminal block)	500 m (1640' 5")	
 FX1N	 FX1N-485-BD (European terminal block)	50 m (164' 0")	
	 FX1N-CNV-BD + FX2NC-485ADP (European terminal block) / FX1N-CNV-BD + FX0N-485ADP (Terminal block)	500 m (1640' 5")	
 FX2N	 FX2N-485-BD	50 m (164' 0")	
	 FX2N-CNV-BD + FX2NC-485ADP (European terminal block) / FX2N-CNV-BD + FX0N-485ADP (Terminal block)	500 m (1640' 5")	

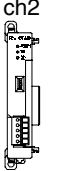
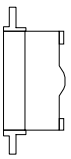
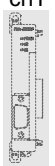
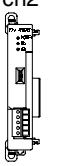
A	Common Items
B	N:N Network
C	Parallel Link
D	Computer Link
E	Inverter Communication
F	Non-Protocol Communication (RS/RS2 Instruction)
G	Non-Protocol Communication (FX2N-232IF)
H	Programming Communication
I	Remote Maintenance

FX Series	Communication equipment (option)	Total extension distance	Check
 <p>FX3U</p>	When using channel 1 (ch 1)		
	 <p>ch1 FX3U-485-BD (European terminal block)</p>	50 m (164' 0")	
	 <p>FX3U-CNV-BD</p> <p>+</p>  <p>ch1 FX3U-485ADP (European terminal block)</p>	500 m (1640' 5")	
	When using channel 2 (ch 2)		
	 <p>ch1 FX3U-□-BD (One is put in □ among 232, 422, 485, and USB).</p> <p>+</p>  <p>ch2 FX3U-485ADP (European terminal block)</p>	500 m (1640' 5")	
	 <p>FX3U-CNV-BD</p> <p>+</p>  <p>ch1 FX3U-□ADP (One is put in □ among 232 and 485).</p> <p>+</p>  <p>ch2 FX3U-485ADP (European terminal block)</p>	500 m (1640' 5")	
	 <p>FX1NC</p>	 <p>FX2NC-485ADP (European terminal block)</p> <p>/</p>  <p>FX0N-485ADP (Terminal block)</p>	500 m (1640' 5")
 <p>FX2NC</p>	 <p>FX2NC-485ADP (European terminal block)</p> <p>/</p>  <p>FX0N-485ADP (Terminal block)</p>	500 m (1640' 5")	

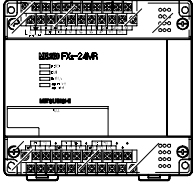
FX Series	Communication equipment (option)	Total extension distance	Check
 <p>FX3UC</p>	When using channel 1 (ch 1)		
	 <p>ch1 FX3U-485-BD (European terminal block)</p>	50 m (164' 0")	
	 <p>FX3U-CNV-BD</p> <p>+</p>  <p>ch1 FX3U-485ADP (European terminal block)</p>	500 m (1640' 5")	
	When using channel 2 (ch 2)		
	 <p>ch1 FX3U-□-BD (One is put in □ among 232, 422, 485, and USB).</p> <p>+</p>  <p>ch2 FX3U-485ADP (European terminal block)</p>	500 m (1640' 5")	
	 <p>FX3U-CNV-BD</p> <p>+</p>  <p>ch1 FX3U-□ADP (One is put in □ among 232 and 485).</p> <p>+</p>  <p>ch2 FX3U-485ADP (European terminal block)</p>	500 m (1640' 5")	

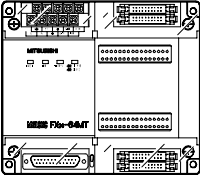
A	Common Items
B	N:N Network
C	Parallel Link
D	Computer Link
E	Inverter Communication
F	Non-Protocol Communication (RS/RS2 Instruction)
G	Non-Protocol Communication (FX2N-232IF)
H	Programming Communication
I	Remote Maintenance

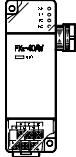
FX Series	Communication equipment (option)	Total extension distance	Check
 <p data-bbox="309 640 399 674">FX2(FX)</p>	 <p data-bbox="730 483 895 535">FX2-40AP (for optical fiber)</p>	<p data-bbox="1214 398 1305 456">50 m (164' 0")</p>	
	 <p data-bbox="746 730 879 781">FX2-40AW (for wire link)</p>	<p data-bbox="1222 647 1297 705">10 m (32' 9")</p>	
 <p data-bbox="325 1137 384 1171">FX2C</p>	 <p data-bbox="730 978 895 1030">FX2-40AP (for optical fiber)</p>	<p data-bbox="1214 893 1305 952">50 m (164' 0")</p>	
	 <p data-bbox="746 1225 879 1276">FX2-40AW (for wire link)</p>	<p data-bbox="1222 1142 1297 1200">10 m (32' 9")</p>	

4. Wiring

This chapter explains the wiring.

WIRING PRECAUTIONS



- Cut off all phases of the power source externally before installation or wiring work in order to avoid electric shock or damage of product.
- Make sure to attach the terminal cover offered as an accessory to the product before turning on the power or starting the operation after installation or wiring work.
Failure to do so may cause electric shock.

WIRING PRECAUTIONS



- Make sure to observe the precautions below in order to prevent any damage to the machine or any accident which may be caused by abnormal data written to the PLC due to the influence of noise:
 - 1) Do not lay close or bundle with the main circuit line, high-voltage line, or load line.
Otherwise, effects of noise or surge induction are likely to take place.
Keep a safe distance of least 100 mm (3.94") from the above lines during wiring.
 - 2) Ground the shield wire or shield of a shielded cable at one point on the PLC. However, do not ground at the same point as high voltage lines.
- Perform wiring properly to the FX0N/FX2N Series extension equipment of the terminal block type in accordance with the precautions below.
Failure to do so may cause electric shock, short-circuit, wire breakage, or damages to the product.
 - The disposal size of the cable end should follow the dimensions described in this manual.
 - Tightening torque should follow the torque described in this manual.
- Observe the following items to wire the lines to the European terminal board. Ignorance of the following items may cause electric shock, short circuit, disconnection, or damage of the product.
 - The disposal size of the cable end should follow the dimensions described in this manual.
 - Tightening torque should follow the torque described in this manual.
 - Twist the end of strand wire and make sure there is no loose wires.
 - Do not solder-plate the electric wire ends.
 - Do not connect electric wires of unspecified size or beyond the specified number of electric wires.
 - Fix the electric wires so that the terminal block and connected parts of electric wires are not directly stressed.

4.1 Wiring Procedure

1 Preparing for wiring

Prepare cables and terminal resistors required in the wiring.

→ For details, refer to Section 4.2.

2 Turning OFF the power to the PLC

Before starting the wiring work, make sure that the power to the PLC is OFF.

3 Connecting the power supply (only the FX0N-485ADP)

Connect the power supply to the 24V DC power terminal.

4 Wiring communication equipment

Connect communication equipment operating in accordance with RS-485.

→ For details, refer to Section 4.3.

A	Common Items
B	N:N Network
C	Parallel Link
D	Computer Link
E	Inverter Communication
F	Non-Protocol Communication (RS/RS2 Instruction)
G	Non-Protocol Communication (FX2N-232IF)
H	Programming Communication
I	Remote Maintenance

4.2 Selecting Cables and Terminal Resistors

Select cables using the procedure described below.

4.2.1 Twisted pair cable

Use shielded twisted pair cables for connecting communication equipment operating in accordance with RS-485.

The table below shows recommended model names and manufacturers of cables used in wiring.

1. Recommended cables

Manufacturer	Model name	Remarks
Mitsubishi Cable Industries, Ltd.	SPEV(SB)-0.2-2P	Two-pair cable of 0.2 mm ²
	SPEV(SB)-MPC-0.2 × 3P	Three-pair cable of 0.2 mm ²
	SPEV(SB)-0.5-2P	Two-pair cable of 0.5 mm ²
Showa Electric Wire & Cable Co., Ltd.	KMPEV-SB CWS-178 0.2SQ × 2P	Two-pair cable of 0.2 mm ²
	KMPEV-SB CWS-178 0.5SQ × 2P	Two-pair cable of 0.5 mm ²
Sumitomo Electric Industries, Ltd.	DPEV SB 0.3 × 3P	Three-pair cable of 0.3 mm ²
	DPEV SB 0.5 × 3P	Three-pair cable of 0.5 mm ²
The Furukawa Electric Co., Ltd.	D-KPEV-SB 0.2 × 3P	Three-pair cable of 0.2 mm ²
	D-KPEV-SB 0.5 × 3P	Three-pair cable of 0.5 mm ²
Fujikura Ltd.	IPEV-SB 2P × 0.3 mm ²	Two-pair cable of 0.3 mm ²
	IPEV-SB 2P × 0.5 mm ²	Two-pair cable of 0.5 mm ²

2. Cable structural drawing (reference)

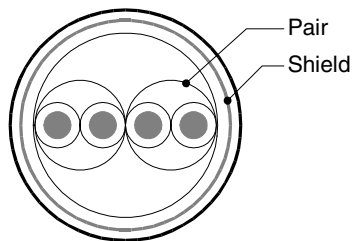

Example of two-pair cable structural drawing

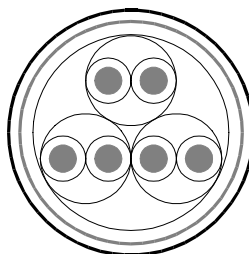

Example of three-pair cable structural drawing

4.2.2 Connecting cables

1. European type terminal block

Use shielded twisted pair cables for connecting communication equipment operating in accordance with RS-485.

The table below shows applicable cables and tightening torque.

	Cable size when one cable is connected	Cable size when two cables are connected	Cable size for bar terminal with insulating sleeve	Tightening torque	Tool size	
					A	B
FX3U-485-BD FX3U-485ADP	AWG22 to AWG20	AWG22	AWG22 to AWG20	0.22 to 0.25 N·m	0.4 (0.01")	2.5 (0.09")
FX2N-485-BD FX1N-485-BD	AWG26 to AWG16		—	0.6 N·m	0.6 (0.03")	3.5 (0.14")
FX2NC-485ADP	AWG26 to AWG16	AWG26 to AWG20	—	0.4 to 0.5 N·m	0.6 (0.03")	3.5 (0.14")

With regard to the cable end treatment, treat a stranded cable or solid cable as it is, or use a bar terminal with insulating sleeve.

- When treating a stranded cable or solid cable as it is
 - Twist the end of a stranded cable so that wires don't get barbed.
 - Do not plate the end of a cable.

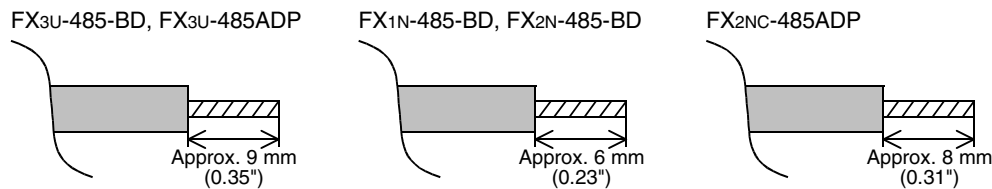

- When using a bar terminal with insulating sleeve
Because it is difficult to insert a cable into an insulating sleeve depending on the cable sheath thickness, select a proper cable according to the outline drawing.

Manufacturer	Model name	Caulking tool
Phoenix Contact	AI 0.5-8WH	CRIMPFOX UD6

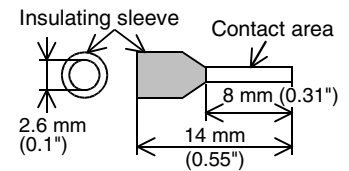

- Tool
 - When tightening a terminal on the European terminal block, use a small commercial screwdriver having straight shape whose tip is not wide as shown in the right figure.

Manufacturer	Model name
Phoenix Contact	SZS 0.4 × 2.5

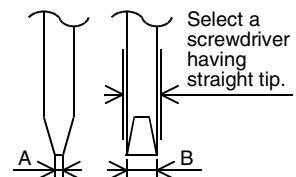

For the size A and size B, refer to the above table.

2. Terminal block

In the FX0N-485ADP and FX-485ADP, the terminal screw size is "M3".

Make sure to use a crimp-style terminal having the following sizes.

Make sure that the tightening torque is 0.5 to 0.8 N·m.

- When wiring one cable to one terminal

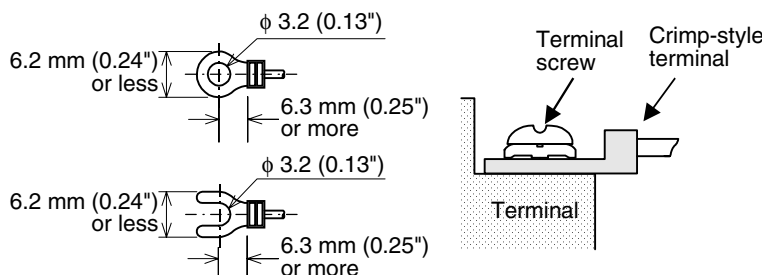

- When wiring two cables to one terminal

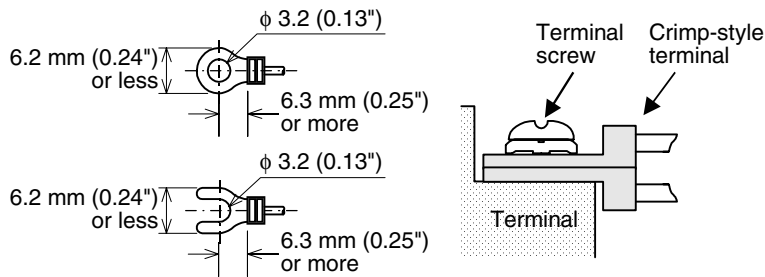

4.2.3 Optical fiber cable

Two optical fiber cables are required.

1. Cable types

Cable	Length	Remarks
F-OFC-M10	10 m (32' 9")	Optical connector CA9104AP manufactured by Hitachi is already connected.
F-OFC-M30	30 m (98' 5")	Optical connector CA9104AP manufactured by Hitachi is already connected.
F-OFC-M50	50 m (164' 0")	Optical connector CA9104AP manufactured by Hitachi is already connected.

2. Cautions on wiring

Separate the optical connector from strong electric cables as much as possible.

Connect devices having as small load as possible to the output terminals Y000 to Y003 which are located near the optical connector.

4.2.4 Connecting terminal resistors

In the case of one-pair wiring, connect a terminal resistor to the RDA-RDB signal terminal in the communication equipment.

In the case of two-pair wiring, connect a terminal resistor to the RDA-RDB signal terminal and SDA-SDB terminal in the communication equipment.

1. Terminal resistor type

In the case of one-pair wiring, use two terminal resistors of 110 Ω, 1/2 W.

In the case of two-pair wiring, use four terminal resistors of 330 Ω, 1/4 W.

Among terminal resistors supplied together with the communication equipment, select ones having the color codes shown on the right.

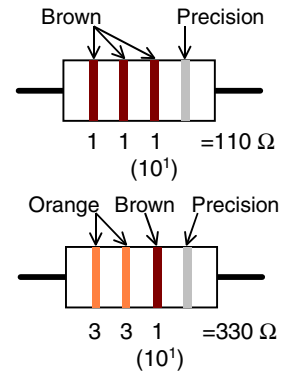

2. When using the FX3U-485-BD or FX3U-485ADP

The FX3U-485-BD and FX3U-485ADP have a built-in terminal resistor.

Set the terminal resistor selector switch accordingly.

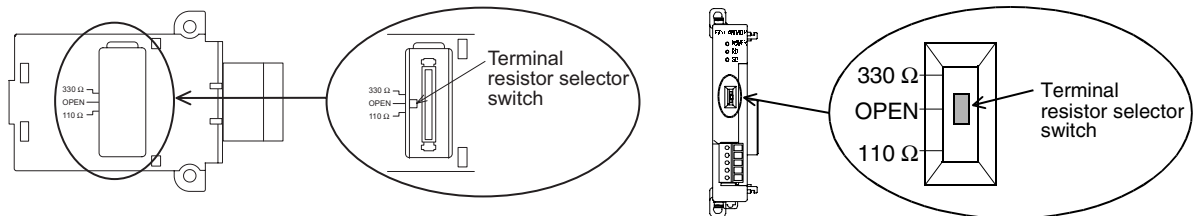

4.3 Connection Diagram

4.3.1 For FX3U and FX3UC PLCs

1. In the case of one-pair wiring

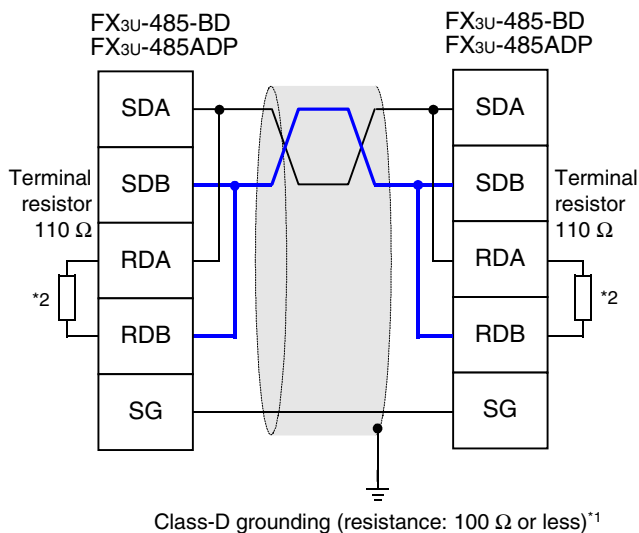

- *1 Make sure to perform Class-D grounding to the shield of a twisted pair cable connected to the FX3U-485-BD or FX3U-485ADP.
- *2 The FX3U-485-BD and FX3U-485ADP have a built-in terminal resistor. Set the terminal resistor selector switch to 110 Ω.

2. In the case of two-pair wiring

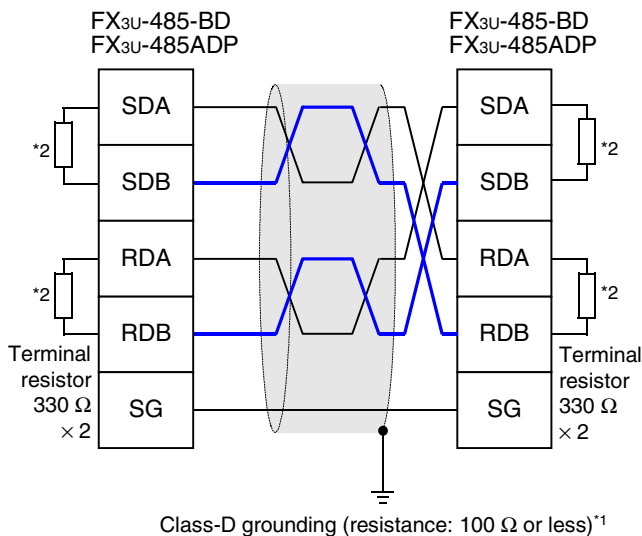

- *1 Make sure to perform Class-D grounding to the shield of a twisted pair cable connected to the FX3U-485-BD or FX3U-485ADP.
- *2 The FX3U-485-BD and FX3U-485ADP have a built-in terminal resistor. Set the terminal resistor selector switch to 330 Ω.

A

Common Items

B

N:N Network

C

Parallel Link

D

Computer Link

E

Inverter Communication

F

Non-Protocol Communication (RS/RSS2 Instruction)

G

Non-Protocol Communication (FX2N-232IF)

H

Programming Communication

I

Remote Maintenance

4.3.2 For FX1S, FX1N, FX1NC, FX2N and FX2NC PLCs

1. In the case of one-pair wiring

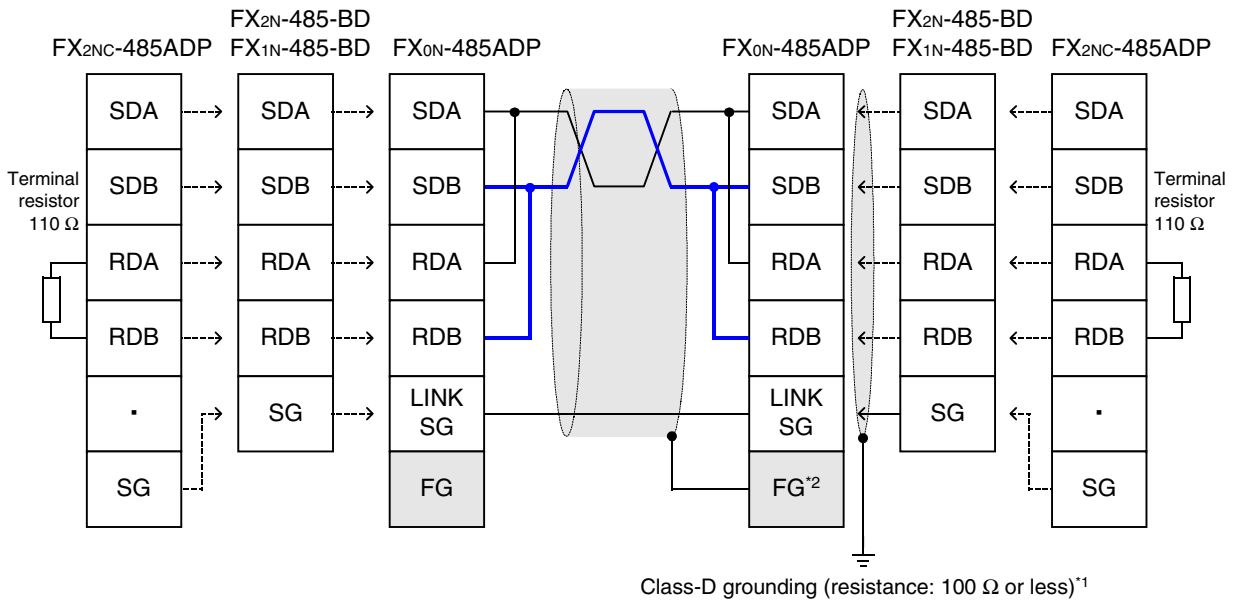

*1 Make sure to perform Class-D grounding to the shield of a twisted pair cable connected to the FX2N-485-BD, FX1N-485-BD or FX2NC-485-ADP.

*2 Make sure to connect the **FG** terminal to the  (grounding) terminal in the PLC requiring Class-D grounding. If the grounding terminal is not provided in the PLC, directly perform Class-D grounding.

2. In the case of two-pair wiring

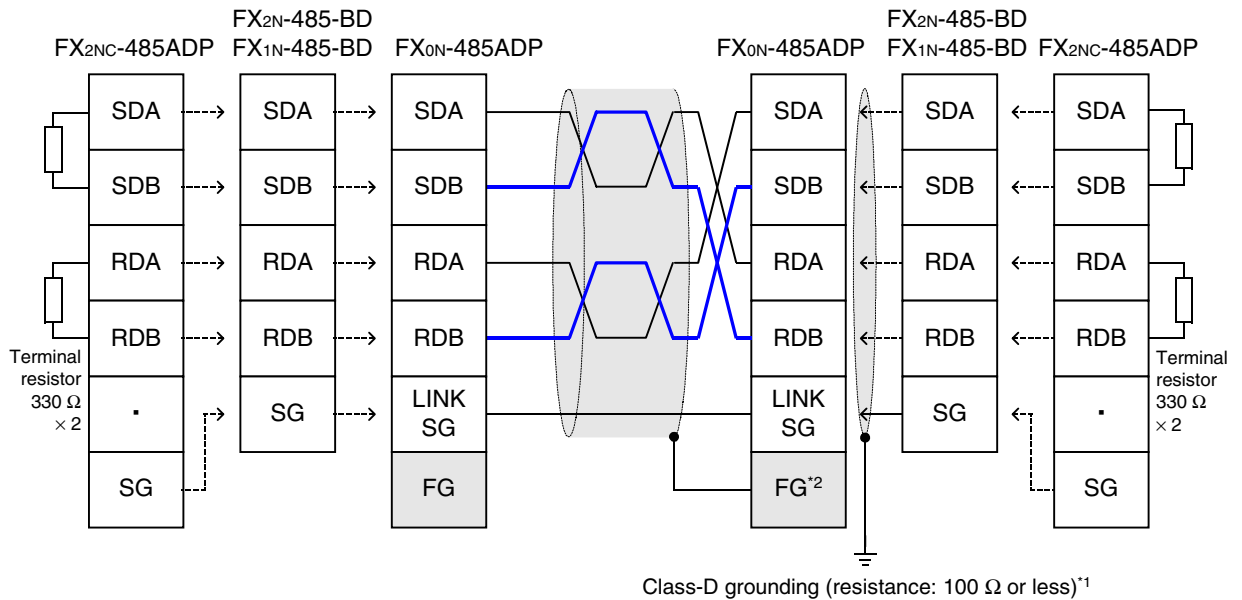

*1 Make sure to perform Class-D grounding to the shield of a twisted pair cable connected to the FX2N-485-BD, FX1N-485-BD or FX2NC-485-ADP.

*2 Make sure to connect the **FG** terminal to the  (grounding) terminal in the PLC requiring Class-D grounding. If the grounding terminal is not provided in the PLC, directly perform Class-D grounding.

4.3.3 For FX2(FX) and FX2c PLCs

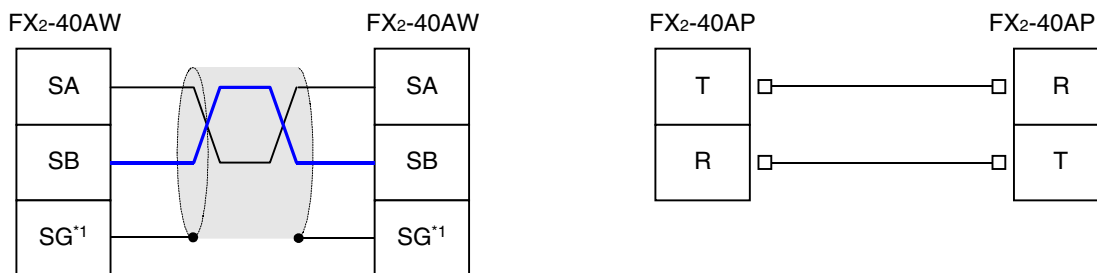

*1 Connect the **SG** terminal to the **SG** terminal in each PLC (main unit).

4.4 Grounding

Grounding should be performed as stated below.

- The grounding resistance should be 100Ω or less.
- Independent grounding should be performed for best results. When independent grounding can not be performed, perform "shared grounding" as shown in the following figure.

→ For details, refer to the Hardware Edition of each series.

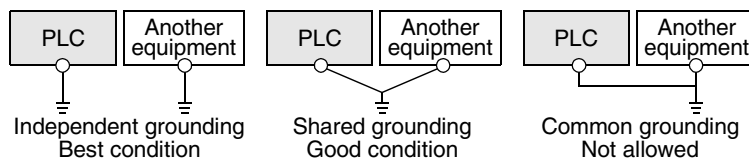

- The grounding wire size should be AWG 14 (2 mm²) or larger.
- The grounding point should be close to the PLC, and all grounding wires should be as short as possible.

A

Common Items

B

N:N Network

C

Parallel Link

D

Computer Link

E

Inverter Communication

F

Non-Protocol Communication (RS/RS2 Instruction)

G

Non-Protocol Communication (FX2N-232IF)

H

Programming Communication

I

Remote Maintenance

5. Communication Setting (Initialization) in FX Programmable Controller

The communication setting is not required in FX PLCs for parallel link.

If the communication setting is already provided for another communication type or for checking the existing communication setting, perform the following procedure.

When executing the parallel link in ch2 in an FX3U or FX3UC PLC, check D8420 using the following procedure.

5.1 Check Procedure

1 Monitoring D8120

Turn ON the power to the PLC while it is in STOP mode, and monitor D8120.

1. When the value of D8120 is "0"

The communication setting is not provided.

2. When the value of D8120 is any value other than "0"

The communication setting is provided.

2 Checking absence/presence of parameter setting

Check absence/presence using the GX Developer or FXGP/WIN.

- 1) GX Developer operating procedure (For details, refer to Section 5.2.)
- 2) FXGP/WIN operating procedure (For details, refer to Section 5.3.)

3 Checking absence/presence of sequence program setting

Verify that an instruction for writing a value to D8120 is programmed or not.

1. When such an instruction is programmed

Program example:

Change the program as shown below, and then change the PLC mode from STOP to RUN.

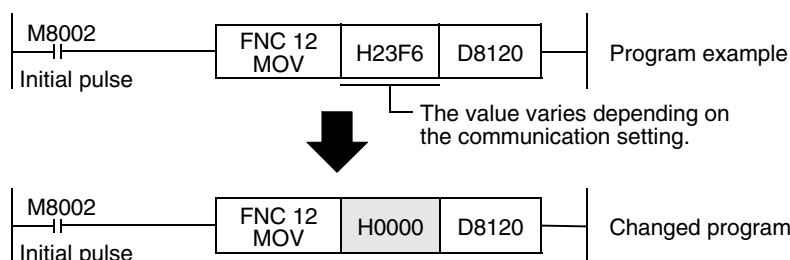

2. When such an instruction is not programmed

Proceed to the next step.

4 Monitoring D8120 again, and confirming that its value is "0"

5.2 Communication Setting in Parameter Method (GX Developer)

Communication settings may be changed by the parameter method with GX Developer and FXGP/WIN for Windows. This section describes how to change parameters with GX Developer.

5.2.1 Operating procedure

With GX Developer open, follow the steps in this section for activating the serial communication setting method.

1 Opening the parameter setting window

Double-click [Parameter]-[PLC parameter] from the project tree.

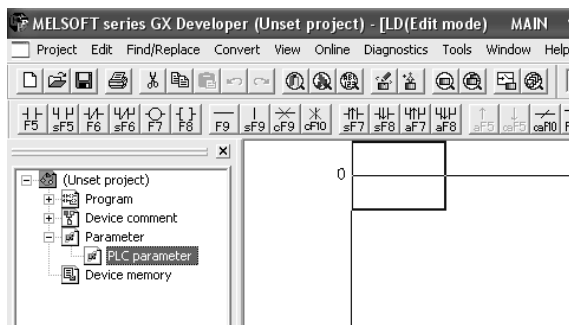

If the project tree is not displayed, select [View] - [Project data list] from the tool menu (to display a check mark on the left side).

2 Setting the serial communication (parameters)

Click the [PLC system(2)] tab on the dialog box.

Select a channel to be used, and confirm that a check mark is not put to the check box "Operate communication setting."

If a check mark is put, delete it.

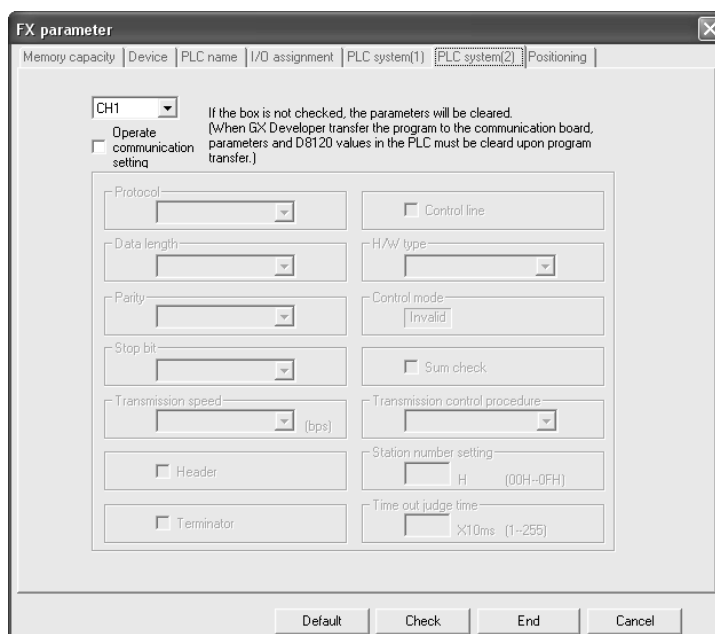

3 Writing parameters and program to the PLC

Select [Online] - [Write to PLC] from the tool menu, put a check mark (✓) in "Parameter" and "Program", and then click [Execute].

5.3 Communication Settings in Parameter Method (FXGP/WIN)

Communication settings may be changed by the parameter method with GX Developer and FXGP/WIN for Windows. This section describes how to change parameters with FXGP/WIN.
Ch2 cannot be set using FXGP/WIN.

5.3.1 Operating procedure

This subsection explains the serial communication setting method. Suppose that FXGP/WIN is already started up.

1 Executing serial communication (parameter) setting

Double-click [Option] - [Serial setting (parameter)] from the tool menu.
The following dialog appears according to absence/presence of parameter setting.

1. When there are no parameter settings

The dialog box shown below appears to indicate that there is not communication setting.
Click the [No] button.
In this case, the next step is not required.

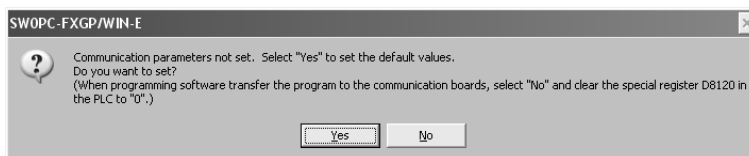

2. When there are already parameter settings

The dialog box shown below appears to indicate that there is communication setting.
Click the [Clear] button to delete the communication setting from parameters.
Transfer parameters to the PLC using the following step.

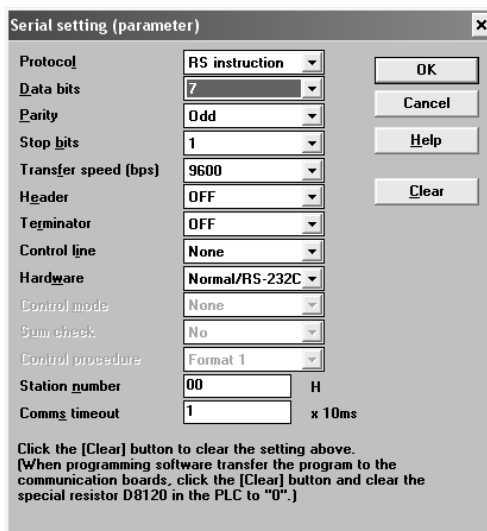

2 Writing a sequence program (parameters) to the PLC

Select [PLC] - [Transfers] - [Write] from the tool menu, and click [OK].

6. Test Run (Communication Test) and Judgement Method

This chapter explains the communication test procedures for the parallel link. It is recommended to wire the master station and slave station, execute communication setting (initialization) in FX PLCs, and then execute the communication test using the following procedure to confirm the operations.

6.1 Test Procedure

1 Creating programs for communication test

Create new programs for communication test for the master station and slave station.
→ For program examples, refer to Section 6.2.

2 Transferring the program to each PLC

Turn ON the power of each PLC, and transfer the program.

3 Validating the communication setting

When the PLC is in RUN mode, set it to STOP mode once, and then set it to RUN mode again. Or turn OFF the power of the master station and slave station, and then turn ON the power of both stations at the same time.

4 Confirming flashing of the communication status indicator lamps (SD and RD)

Confirm that the SD and RD lamps built in the communication equipment are flashing. If they are off, take proper action while referring to the troubleshooting procedures described later.

5 Confirming the link of the master station

Set to ON or OFF the PLC inputs (X000 to X003) in the master station, and confirm that the outputs (Y000 to Y003) turn ON or OFF in the slave station.

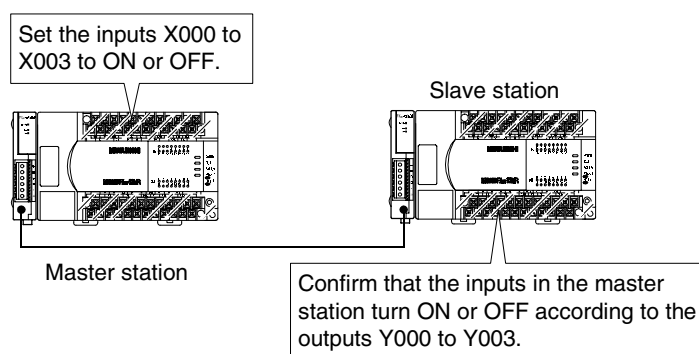

A

Common Items

B

N:N Network

C

Parallel Link

D

Computer Link

E

Inverter Communication

F

Non-Protocol Communication (RS/RS2 Instruction)

G

Non-Protocol Communication (FX2N-2321F)

H

Programming Communication

I

Remote Maintenance

6 Confirming the link of the slave station

Set to ON or OFF the PLC inputs (X000 to X003) in the slave station, and confirm that the outputs (Y000 to Y003) turn ON or OFF in the master station.

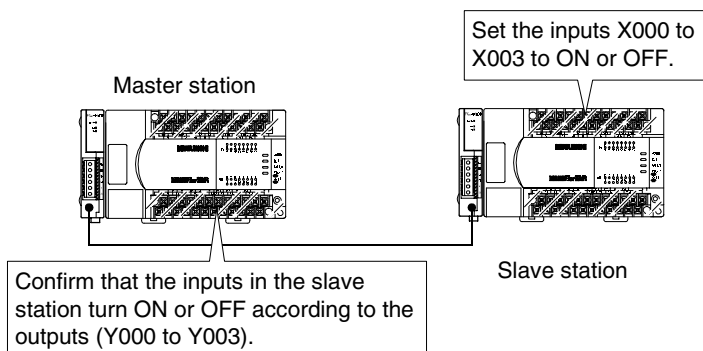

→ When the link is disabled, refer to "9. Troubleshooting."

6.2 Creating Programs for Communication Test

Create the programs shown below for the master station and slave station.

6.2.1 For FX2(FX), FX2C, FX1N, FX2N, FX3U, FX1NC, FX2NC or FX3UC Series

1. Program for communication test (for the master station)

Create the program shown below for the communication test. (This program is not required during actual operation.)

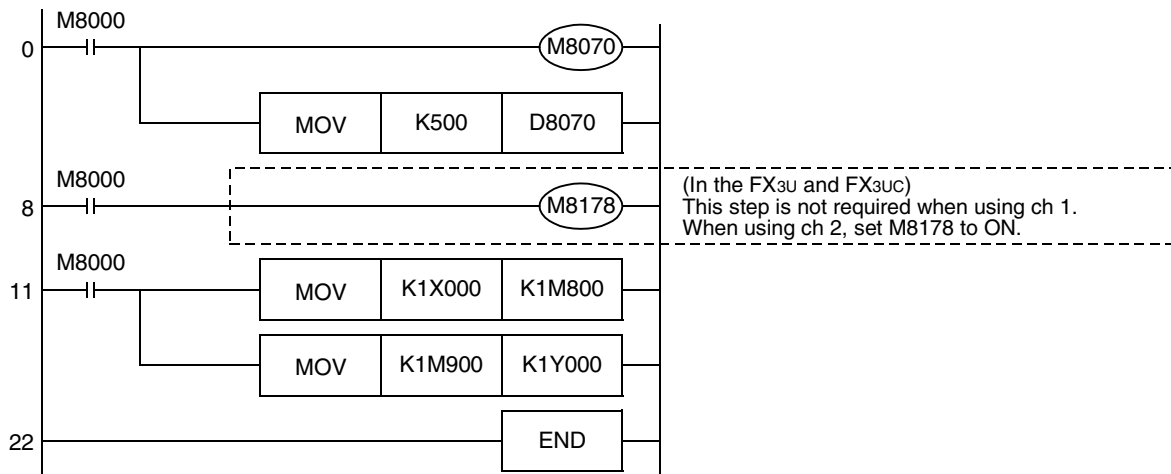

2. Program for communication test (for the slave station)

Create the program shown below for the communication test. (This program is not required during actual operation.)

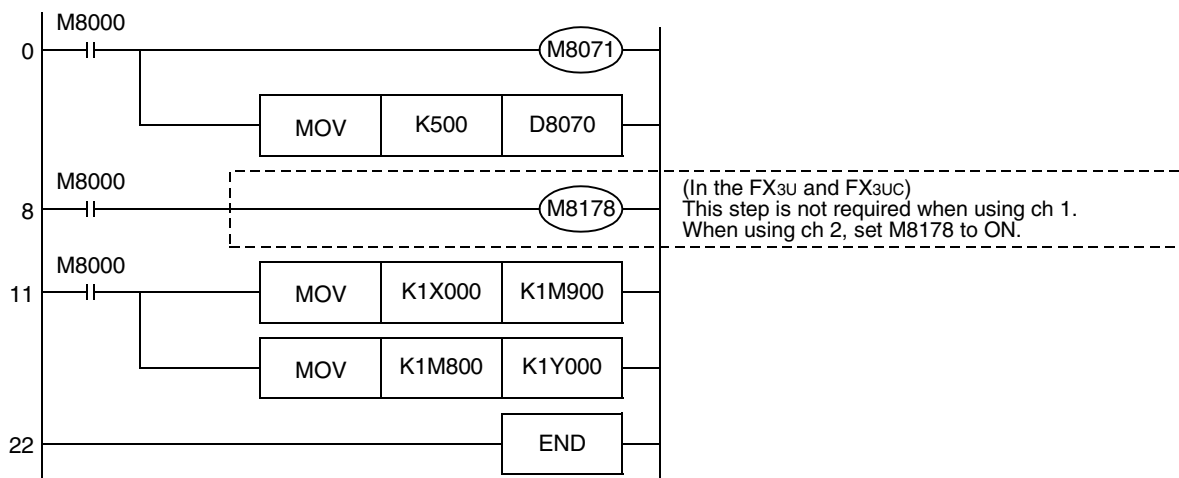

6.2.2 For FX1S or FX0N Series

1. Program for communication test (for the master station)

Create the program shown below for the communication test. (This program is not required during actual operation.)

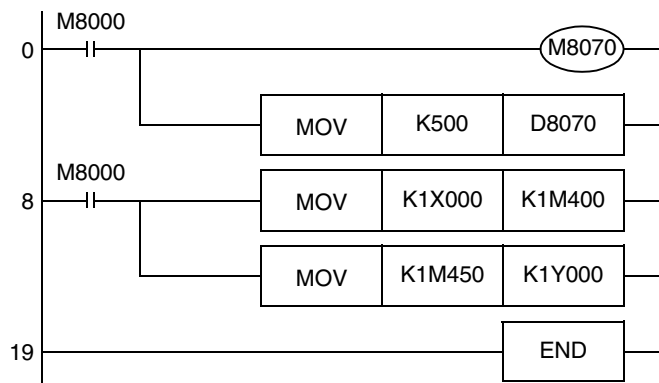

2. Program for communication test (for the slave station)

Create the program shown below for the communication test. (This program is not required during actual operation.)

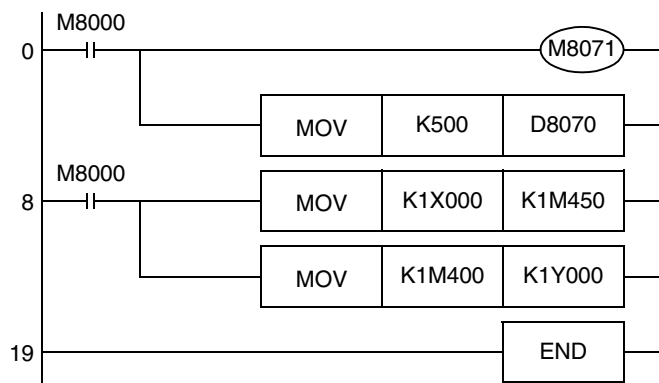

A	Common Items
B	N:N Network
C	Parallel Link
D	Computer Link
E	Inverter Communication
F	Non-Protocol Communication (RS/RS2 Instruction)
G	Non-Protocol Communication (FX2N-232IF)
H	Programming Communication
I	Remote Maintenance

7. Creating Programs

The parallel link has two modes, regular parallel link mode and high speed parallel link mode. Program settings and the number of device to be used are different in each mode. When connecting FX PLCs in the parallel link, set the same mode in both PLCs.

7.1 Regular Parallel Link Mode

This section explains the program setting method in the regular parallel link mode.

7.1.1 Checking contents of related devices

The tables below show devices used in the parallel link.

1. Devices for setting the parallel link

These devices are used for setting the parallel link. Setting of these devices is essential in using the parallel link.

Device	Name	Description
M8070	Parallel link master station declare	Set this device to ON when linking a PLC as the master station.
M8071	Parallel link slave station declare	Set this device to ON when linking a PLC as the slave station.
M8178	Channel setting	Set the channel of communication port to be used (in the FX3U and FX3UC). When this device is OFF: ch1 When this device is ON: ch2
D8070	Error judgement time (ms)	Set the time for judging error in the parallel link data communication. [Initial value: 500]

2. Devices for judging errors in the parallel link

These devices are used for judging errors in the parallel link. Use them to output link errors to the outside and interlock sequence programs.

Device	Name	Description
M8072	Parallel link ON	This device remains ON while the parallel link is executed.
M8073	Master/slave station setting error	This device turns ON when there is an error in the setting of the master station or slave station.
M8063	Link error	This device turns ON when a communication error occurs.

3. Link devices

1) Sending devices for the master station

These devices are used for sending the information from the master station to the slave station. Do not change the setting of these devices in the slave station so that they don't cause malfunction. The used device numbers and number of devices vary depending on the PLC type. For applicable devices, refer to the tables below.

a) For FX2(FX), FX2C, FX1N, FX2N, FX3U, FX1NC, FX2NC or FX3UC Series

Device		Number of devices	Description
Bit device	M800 to M899	100	The devices in the slave station are automatically updated to the status of devices in the master station.
Word device	D490 to D499	10	

b) For FX1S or FX0N Series

Device		Number of devices	Description
Bit device	M400 to M449	50	The devices in the slave station are automatically updated to the status of devices in the master station.
Word device	D230 to D239	10	

2) Sending devices for the slave station

These devices are used for sending the information from the slave station to the master station. Do not change the setting of these devices in the master station so that they don't cause malfunction. The used device numbers and number of devices vary depending on the PLC type. For applicable devices, refer to the tables below.

a) For FX2(FX), FX2C, FX1N, FX2N, FX3U, FX1NC, FX2NC or FX3UC Series

Device		Number of devices	Description
Bit device	M900 to M999	100	The devices in the master station are automatically updated to the status of devices in the slave station.
Word device	D500 to D509	10	

b) For FX1S or FX0N Series

Device		Number of devices	Description
Bit device	M450 to M499	50	The devices in the master station are automatically updated to the status of devices in the slave station.
Word device	D240 to D249	10	

A	Common Items
B	N:N Network
C	Parallel Link
D	Computer Link
E	Inverter Communication
F	Non-Protocol Communication (RS/RS2 Instruction)
G	Non-Protocol Communication (FX2N-232IF)
H	Programming Communication
I	Remote Maintenance

7.1.2 Creating programs for master station

Create programs for the master station.

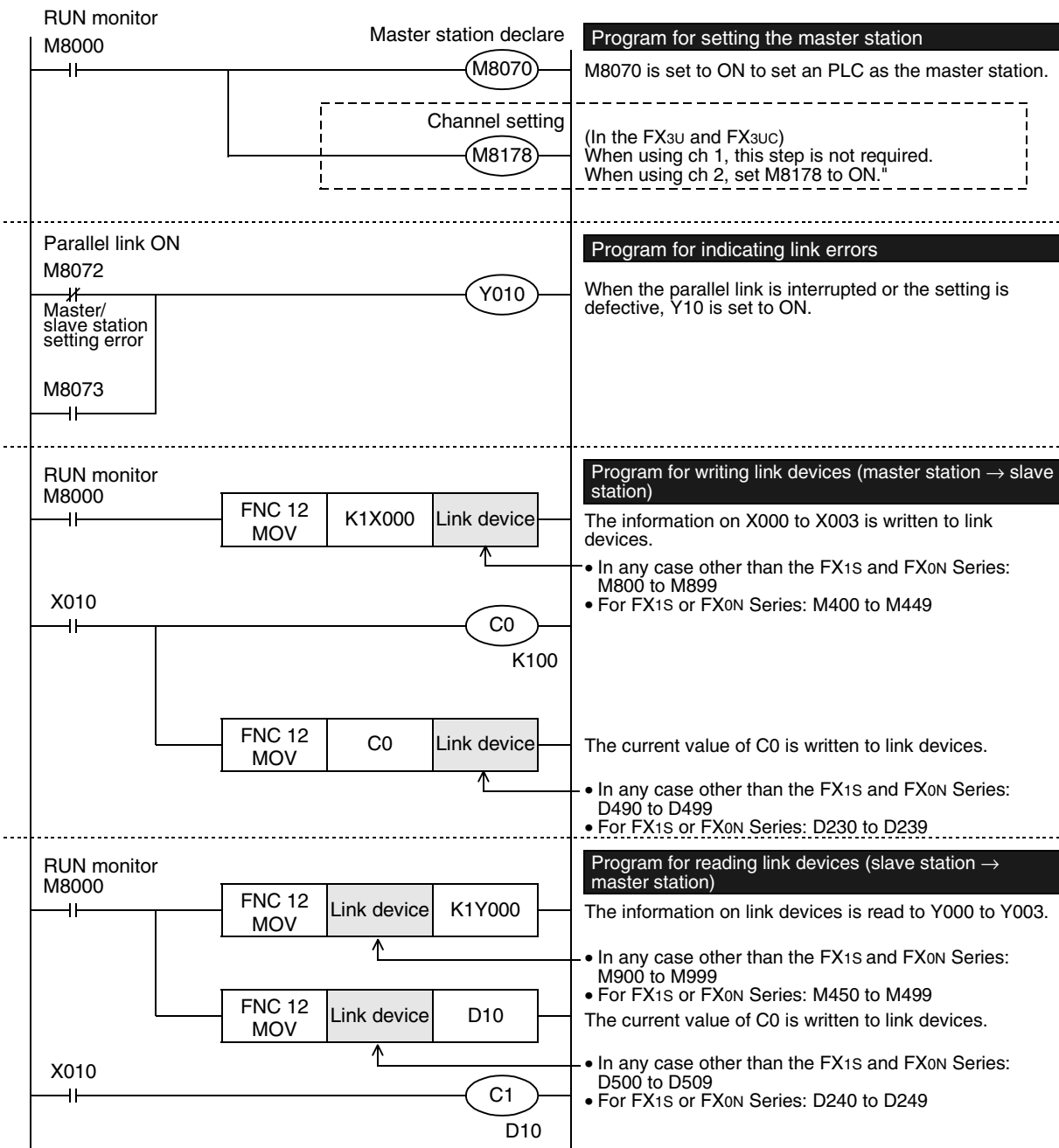

7.1.3 Creating programs for slave station

Create programs for the slave station.

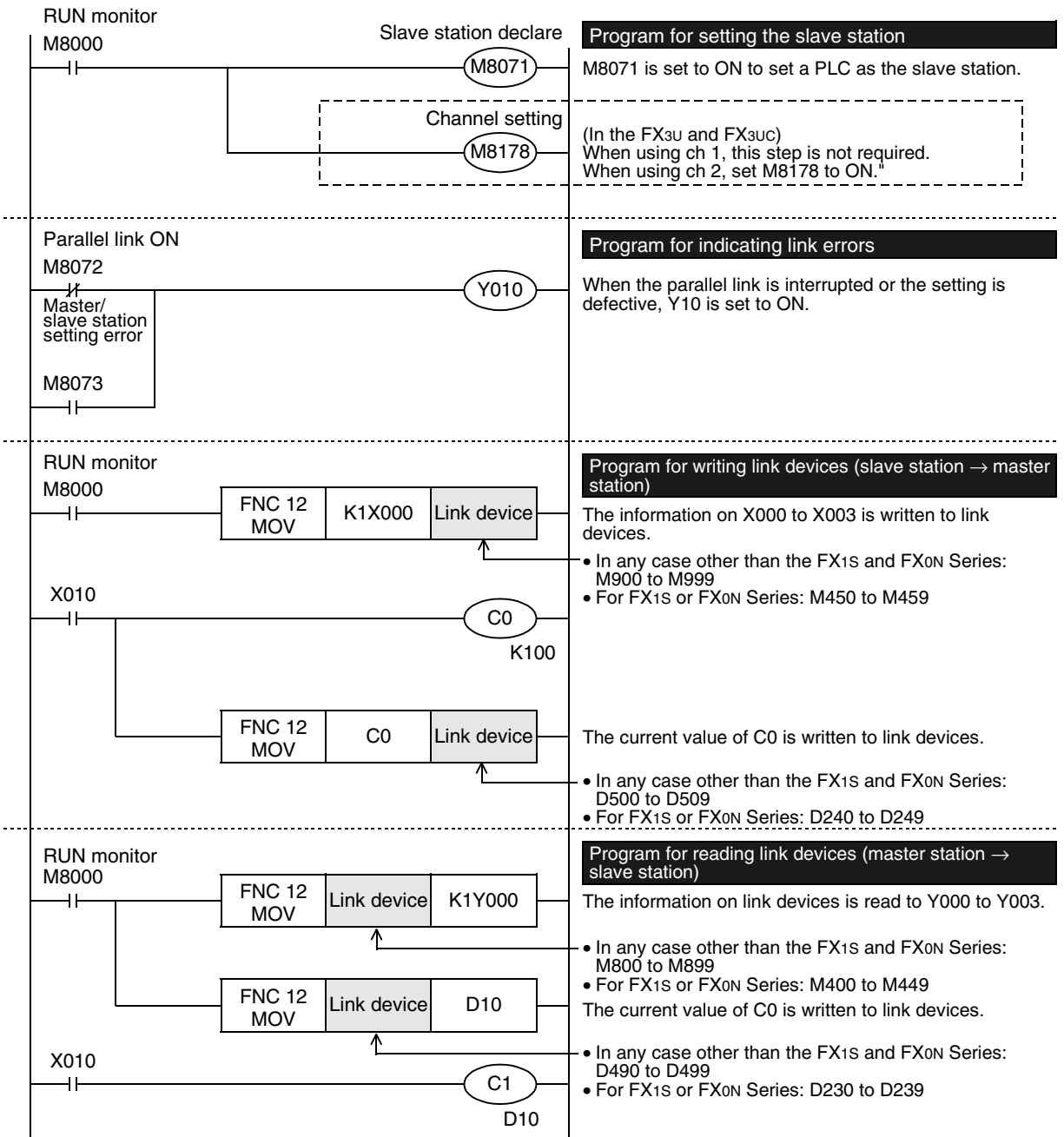

A	Common Items
B	N:N Network
C	Parallel Link
D	Computer Link
E	Inverter Communication
F	Non-Protocol Communication (RS/RS2 Instruction)
G	Non-Protocol Communication (FX2N-232IF)
H	Programming Communication
I	Remote Maintenance

7.2 High Speed Parallel Link Mode

This section explains the program setting method in the high speed parallel link mode.

7.2.1 Checking contents of related devices

The tables below show devices used in the parallel link.

1. Devices for setting the parallel link

These devices are used for setting the parallel link. Setting of these devices is essential in using the parallel link.

Device	Name	Description
M8070	Parallel link master station declare	Set this device to ON when linking a PLC as the master station.
M8071	Parallel link slave station declare	Set this device to ON when linking a PLC as the slave station.
M8162	High speed parallel link mode	Set this device to ON when using the high speed parallel link mode.
M8178	Channel setting	Set the channel of communication port to be used (in the FX3U and FX3UC). When this device is OFF: ch1 When this device is ON: ch2
D8070	Error judgement time (ms)	Set the time for judging error in the parallel link data communication. [Initial value: 500]

2. Devices for judging errors in the parallel link

These devices are used for judging errors in the parallel link. Use them to output link errors to the outside and interlock sequence programs.

Device	Name	Description
M8072	Parallel link ON	This device remains ON while the parallel link is executed.
M8073	Master/slave station setting error	This device turns ON when there is an error in the setting of the master station or slave station.
M8063	Link error	This device turns ON when a communication error occurs.

3. Link devices

1) Sending devices for the master station

These devices are used for sending the information from the master station to the slave station.

Do not change the setting of these devices in the slave station. Such changes cause malfunction.

The used device numbers and number of devices vary depending on the PLC type. For applicable devices, refer to the tables below.

a) For FX2(FX), FX2C, FX1N, FX2N, FX3U, FX1NC, FX2NC or FX3UC Series

Device	Number of devices	Description
Word device D490, D491	2	The devices in the slave station are automatically updated to the status of devices in the master station.

b) For FX1S or FX0N Series

Device	Number of devices	Description
Word device D230, D231	2	The devices in the slave station are automatically updated to the status of devices in the master station.

2) Sending devices for the slave station

These devices are used for sending the information from the slave station to the master station. Do not change the setting of these devices in the master station so that they don't cause malfunction. The used device numbers and number of devices vary depending on the PLC type. For applicable devices, refer to the tables below.

a) For FX2(FX), FX2C, FX1N, FX2N, FX3U, FX1NC, FX2NC or FX3UC Series

Device		Number of devices	Description
Word device	D500, D501	2	The devices in the master station are automatically updated to the status of devices in the slave station.

b) For FX1S or FX0N Series

Device		Number of devices	Description
Word device	D240, D241	2	The devices in the master station are automatically updated to the status of devices in the slave station.

A	Common Items
B	N:N Network
C	Parallel Link
D	Computer Link
E	Inverter Communication
F	Non-Protocol Communication (RS/RS2 Instruction)
G	Non-Protocol Communication (FX2N-232IF)
H	Programming Communication
I	Remote Maintenance

7.2.2 Creating programs for master station

Create programs for the master station.

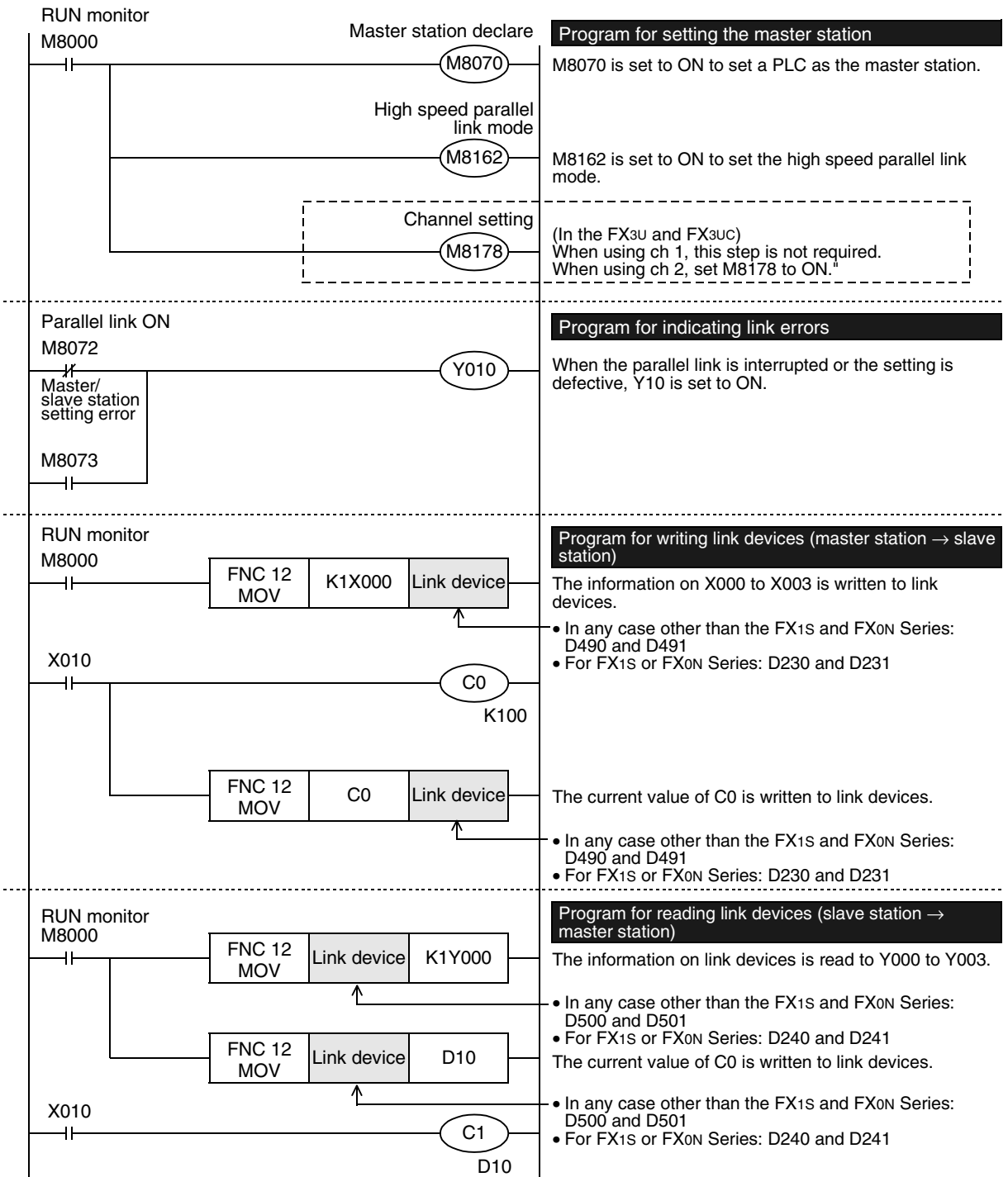

7.2.3 Creating programs for slave station

Create programs for the slave station.

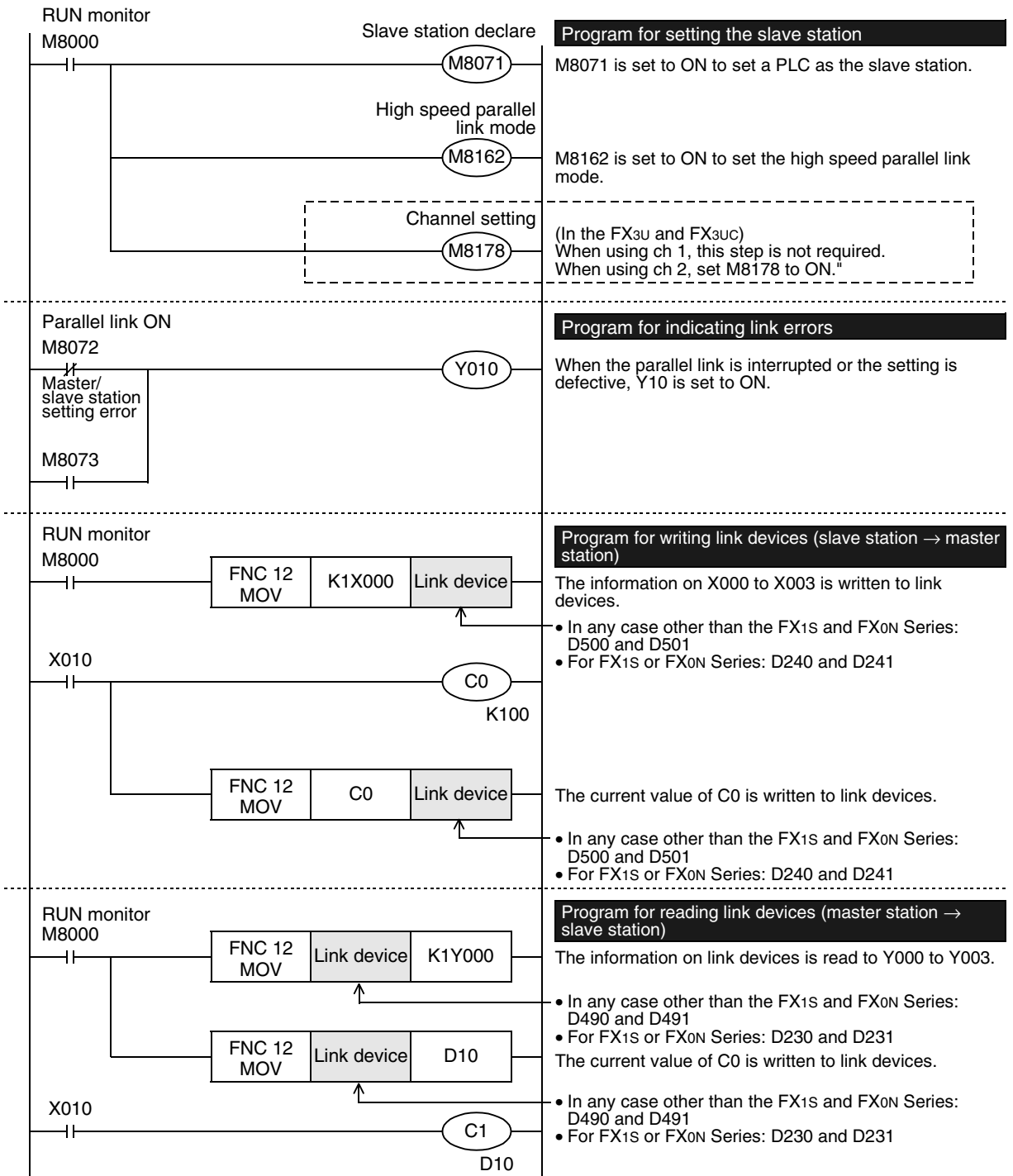

A	Common Items
B	N:N Network
C	Parallel Link
D	Computer Link
E	Inverter Communication
F	Non-Protocol Communication (RS/RS2 Instruction)
G	Non-Protocol Communication (FX2N-232IF)
H	Programming Communication
I	Remote Maintenance

7.3 Cautions on Program Creation

1. Program for reading link devices

- 1) Do not change the contents of link devices for the other station.
- 2) When a link error occurs, the link device information remains the same as the status just before the error.
Create a fail-safe program which does not cause abnormality even if a link error occurs.

2. Cautions on using FX3U/FX3UC PLCs

- 1) Only ch1 or ch2 can be set in the parallel link.
- 2) Do not use the N:N Network and the parallel link at the same time.
(For example, it is not allowed to use ch1 for the N:N Network and simultaneously use ch2 for the parallel link.)

8. Practical Program Examples

This chapter shows practical programs.

8.1 Practical Example 1 (Regular Parallel Link Mode)

When many link devices are required, use the regular parallel link mode.

8.1.1 System configuration example

The example below shows a system configuration in which two FX2N PLCs are linked.



- Link range: 100-bit devices and 10-word devices (regular parallel link mode)
- Error judgement time: 500 ms

8.1.2 Setting contents

The program examples shown later adopt the following communication parameters:

Device	Description
M8070	Parallel link master station declare
M8071	Parallel link slave station declare
D8070	Communication error judgement time

A

Common Items

B

N:N Network

C

Parallel Link

D

Computer Link

E

Inverter Communication

F

Non-Protocol Communication (RS/RS2 Instruction)

G

Non-Protocol Communication (FX2N-232IF)

H

Programming Communication

I

Remote Maintenance

8.1.3 Program for master station

For the master station, refer to the program shown below.

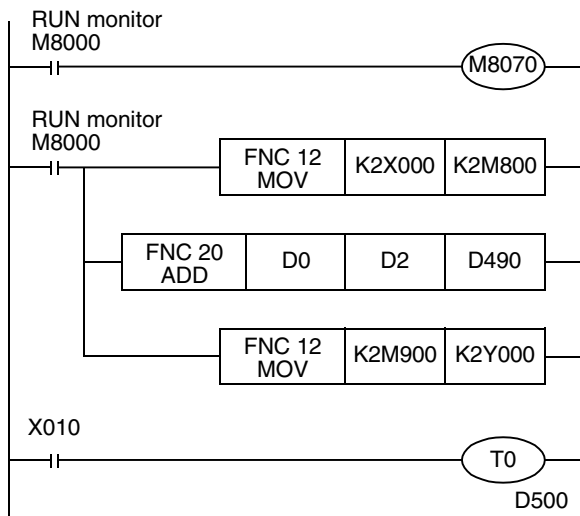

The ON/OFF status of inputs X000 to X007 in the master station is output to Y000 to Y007 in the slave station.

When the calculation result (D0 + D2) in the master station is 100 or less, Y010 is set to ON in the slave station.

The ON/OFF status of M0 to M7 in the slave station is output to Y000 to Y007 in the master station.

The value of D10 in the slave station stored to the timer setting (T0) in the master station.

8.1.4 Program for slave station

For the slave station, refer to the program shown below.

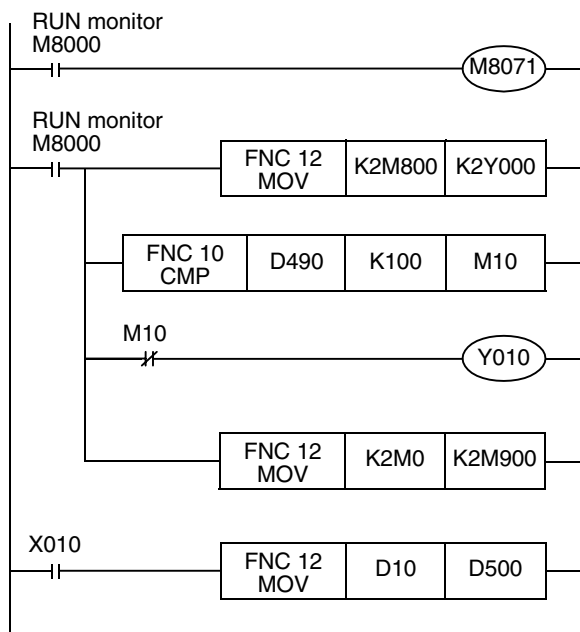

The ON/OFF status of inputs X000 to X007 in the master station is output to Y000 to Y007 in the slave station.

When the calculation result (D0 + D2) in the master station is 100 or less, Y010 is set to ON in the slave station.

The ON/OFF status of M0 to M7 in the slave station is output to Y000 to Y007 in the master station.

The value of D10 in the slave station stored to the timer setting (T0) in the master station.

9. Troubleshooting

This chapter explains troubleshooting.

9.1 Checking FX PLC Version Applicability

Verify that the FX PLC main unit is an applicable version.

→ For the version applicability check, refer to Section 1.3.

9.2 Checking Communication Status Based on LED Indication

Check the status of the "RD" and "SD" indicator LEDs provided in the optional equipment.

LED status		Operation status
RD	SD	
Flashing	Flashing	Data is being sent or received.
Flashing	Off	Data is received, but is not sent.
Off	Flashing	Data is sent, but is not received.
Off	Off	Data is not sent or received.

While the parallel link is executed normally, both LEDs flash brightly.

If they do not flash, check the wiring and the communication setting in the master and slave stations.

9.3 Checking Installation and Wiring

1. Mounting status

If the communication equipment is not securely connected to the PLC, communication is disabled.

→ For the mounting method, refer to the manual of each communication equipment.

2. Power supply (for FX0N-485ADP)

The FX0N-485ADP requires a driving power supply. Verify that the power supply is correctly provided.

3. Wiring

Verify that the wiring to each communication equipment is correct. Incorrect wiring disables communication.

→ For the wiring method check, refer to Chapter 4.

9.4 Checking Sequence Program

1. Communication setting in a sequence program

Verify that N:N Network (D8173 to D8180) is not set. It is not allowed to use both the parallel link and N:N Network at the same time.

Verify that the communication format (D8120 and D8420) is set correctly. Communication is disabled if a communication port is set twice or more.

After changing any setting, make sure to reboot the PLC's power.

→ For the communication setting, refer to Chapter 5.

2. Communication setting using parameters

Verify that the communication setting using parameters are suitable for use. If the communication setting is not suitable for use, communication is not executed correctly.

After changing any setting, make sure to reboot the PLC's power.

→ For the communication setting, refer to Chapter 5.

A	Common Items
B	N:N Network
C	Parallel Link
D	Computer Link
E	Inverter Communication
F	Non-Protocol Communication (RS/RS2 Instruction)
G	Non-Protocol Communication (FX2N-232IF)
H	Programming Communication
I	Remote Maintenance

3. Presence of VRRD and VRSC instructions (except FX3U and FX3UC PLCs)

Verify that VRRD and VRSC instructions are not used in a program.
If these instructions are used, delete them, reboot the PLC's power.

4. Presence of RS instruction (except FX3U and FX3UC PLCs)

Verify that RS instruction is not used in a program.
If this instruction is used, delete it, reboot the PLC's power.

5. Presence of RS/RS2 instruction (in FX3U and FX3UC PLCs)

Verify that RS and RS2 instructions are not used in the same channel.
If these instructions are used in the same channel, delete them, reboot the PLC's power.

6. Presence of EXTR instruction (in FX2N and FX2NC PLCs)

Verify that EXTR instruction is not used in a program.
If this instruction is used, delete it, reboot the PLC's power.

7. Presence of IVCK, IVDR, IVRD, IVWR, and IVBWR instructions (in FX3U and FX3UC PLCs)

Verify that IVCK, IVDR, IVRD, IVWR and IVBWR instructions are not used in the same channel.
If these instructions are used in the same channel, delete them, reboot the PLC's power.

9.5 Checking Absence/Presence of Errors

Verify that errors have not occurred in the master station and slave station. Errors can be checked using the flags shown below.

1. Checking the device M8072

While the parallel link is executed, M8072 remains ON.
If M8072 is OFF, an error has occurred in the parallel link setting or communication.

2. Checking the device M8073

If the parallel link is not set correctly, M8073 turns ON.
If M8073 is ON, verify that the master station and slave station are set correctly in sequence programs.

3. Devices for checking link errors

- 1) Checking the error flags M8063 and M8438 (in the FX3U and FX3UC)

If a communication error occurs in the parallel link, the serial communication error flag turns ON.
When ch1 is used, M8063 turns ON. When ch2 is used in the FX3U and FX3UC, M8438 turns ON.
When the serial communication error flag turns ON, the error code is stored in D8063 or D8438.
- 2) Checking the error code

When a communication error occurs in the parallel link using ch 1, the error code is stored in D8063.
When a communication error occurs in the parallel link using ch 2, the error code is stored in D8438.
The table below shows the details of error codes.

Device	Error code	Description	Action
D8063	0000	No error	Verify that the parallel link setting programs are set correctly. Check the wiring also.
	6312	Character error in parallel link	
	6313	Sum check error in parallel link	
	6314	Format error in parallel link	
D8438 (in FX3U and FX3UC)	0000	No error	
	3812	Character error in parallel link	
	3813	Sum check error in parallel link	
	3814	Format error in parallel link	

Caution

The devices for checking link errors are not cleared even after communication errors are reset.
They are cleared when the PLC mode is changed from STOP to RUN.

10. Related Data

10.1 Related Device List

1. Bit devices

Device number	Name	Description	Initial value	Detection	R/W
Devices for communication setting					
M8070	Parallel link master station declare	Links a PLC as the master station when it turns ON.	–	M	W
M8071	Parallel link slave station declare	Links a PLC as the slave station when it turns ON.	–	L	W
M8162	High speed parallel link mode	Turns ON when two-word device communication mode is selected.	–	M, L	W
M8178	Channel setting	Sets the communication port to be used (in the FX3U and FX3UC). OFF: ch1, ON: ch2	–	M, L	W
Devices for checking communication status					
M8072	Parallel link ON	Remains ON while the parallel link is being executed.	–	M, L	R
M8073	Parallel link setting error	Turns ON when an error is included in the setting contents of the master station or slave station.	–	M, L	R
M8063	Serial communication error 1 (ch 1)	Turns ON when an error occurs in serial communication using ch 1.	–	M, L	R
M8438	Serial communication error 2 (ch 2)	Turns ON when an error occurs in serial communication using ch 2 (in the FX3U and FX3UC).	–	M, L	R

R: For reading only (used as a contact in program)

W: For writing only

M: Master station

L: Slave station

2. Word devices (data registers)

Device number	Name	Description	Initial value	Detection	R/W
Devices for communication setting					
D8070	Error judgement time	Sets the error judgement time for data communication in the parallel link.	500	M, L	W
Devices for checking communication status					
D8063	Serial communication error code (ch 1)	Stores the error code when an error occurs in serial communication using ch 1.	0000	M, L	R
D8438	Serial communication error code (ch 2)	Stores the error code when an error occurs in serial communication using ch 2 (in the FX3U and FX3UC).	0000	M, L	R

R: For reading only (used as a contact in program)

W: For writing only

M: Master station

L: Slave station

A

Common Items

B

N:N Network

C

Parallel Link

D

Computer Link

E

Inverter Communication

F

Non-Protocol Communication (RS/RS2 Instruction)

G

Non-Protocol Communication (FX2N-232IF)

H

Programming Communication

I

Remote Maintenance

10.2 Details of Related Devices

The devices described below are used in parallel link.

10.2.1 Parallel link master station declare [M8070]

When this device is set to ON, the PLC is handled as the master station in the started communication.

1. Stations requiring program setting

The master station requires program setting.

2. Detailed contents

In the FX PLC to be handled as the master station, set M8070 to "normally ON" using M8000.

3. Cautions on use

Set this device to ON in a sequence program.

10.2.2 Channel setting [M8178]

This device works as the channel setting flag (in the FX3U and FX3UC).

1. Stations requiring program setting

The master and slave station require program setting.

2. Detailed contents

When the communication port to be used is ch 2, set this device to ON in a sequence program.
When using ch 1, the sequence program is not required.

10.2.3 Parallel link slave station declare [M8071]

When this device is set to ON, the PLC is handled as the slave station in the started communication.

1. Stations requiring program setting

The slave station requires program setting.

2. Detailed contents

In the FX PLC to be handled as a slave station, set M8071 to "normally ON" using M8000.

3. Cautions on use

Set this device to ON in a sequence program.

10.2.4 High speed parallel link mode [M8162]

When M8162 turns OFF, the regular parallel link mode is selected. When M8162 turns ON, the high speed parallel link mode is selected.

1. Stations requiring program setting

The master and slave station require program setting.

2. Detailed contents

The table below shows the number of link devices.

PLC	Regular parallel link mode		High speed parallel link mode	
	Bit device (M)	Word device (D)	Bit device (M)	Word device (D)
FX2(FX), FX2C, FX1N, FX2N, FX3U, FX1NC, FX2NC, FX3UC	100 in each station	10 in each station	0	2 in each station
FX1S, FX0N	50 in each station	10 in each station	0	2 in each station

3. Cautions on use

Set this device to ON in a sequence program.

10.2.5 Parallel link ON [M8072]

This device is provided to verify that the parallel link is being executed.

1. Stations requiring program setting

To check the parallel link status, the master and slave station require program setting.

2. Detailed contents

M8072 remains ON while the parallel link is being executed normally, and remains OFF while the parallel link is not being executed normally.

10.2.6 Parallel link setting error [M8073]

This device is provided to verify that the setting is correct in the master station and slave station in the parallel link.

1. Stations requiring program setting

To check the parallel link status, the master and slave station require program setting.

2. Detailed contents

M8073 remains OFF when the setting is correct in the master station or slave station, and turns ON when the setting is incorrect.

10.2.7 Serial communication error [M8063 and M8438]

These devices are provided to check communication errors. (M8438 is available only in the FX3U and FX3UC.)

1. Stations requiring program setting

To check communication errors, the master and slave station require program setting.

2. Detailed contents

M8063 turns ON when an error occurs in the parallel link using ch 1. When M8063 turns ON, the error code is stored in D8063.

M8438 turns ON when an error occurs in the parallel link using ch 2. When M8438 turns ON, the error code is stored in D8438.

3. Cautions on use

These devices do not turn OFF even after the communication error is reset. They turn OFF when the PLC mode is changed from STOP to RUN.

10.2.8 Error judgement time setting [D8070]

This device is provided to set the error judgment time (initial value: 500 ms).

1. Stations requiring program setting

To change the set value from the initial value, the master and slave station require program setting.

2. Detailed contents

When data transmission requires time longer than the time set here, it is regarded as error.

A

Common Items

B

N:N Network

C

Parallel Link

D

Computer Link

E

Inverter Communication

F

Non-Protocol Communication (RS/RS2 Instruction)

G

Non-Protocol Communication (FX2N-232IF)

H

Programming Communication

I

Remote Maintenance

10.2.9 Serial communication error code [D8063 and D8438]

These devices store the serial communication error code. (D8438 is available only in the FX3U and FX3UC.)

1. Stations requiring program setting

To check the error code, the master and slave station require program setting.

2. Detailed contents

The table below shows the details of error codes.

Device	Error code	Description	Action
D8063 (ch 1)	0000	No error	Verify that the parallel link setting programs are set correctly. Check the wiring also.
	6312	Character error in parallel link	
	6313	Sum check error in parallel link	
D8438 (ch 2)	6314	Format error in parallel link	
	0000	No error	
	3812	Character error in parallel link	
	3813	Sum check error in parallel link	
	3814	Format error in parallel link	

3. Cautions on use

The error code is not cleared even after the communication error is reset.
 It is cleared when the PLC mode is changed from STOP to RUN.

FX Series Programmable Controllers

User's Manual [Computer Link]

A

Common Items

B

N:N Network

C

Parallel Link

D

Computer Link

E

Inverter
Communication

F

Non-Protocol
Communication
(RS/RS2 Instruction)

G

Non-Protocol
Communication
(FX2N-232IF)

H

Programming
Communication

I

Remote
Maintenance

Foreword

This manual explains "computer link" provided in MELSEC-F FX Series Programmable Controllers and should be read and understood before attempting to install or use the unit. Store this manual in a safe place so that you can take it out and read it whenever necessary. Always forward it to the end user.

This manual confers no industrial property rights or any rights of any other kind, nor does it confer any patent licenses. Mitsubishi Electric Corporation cannot be held responsible for any problems involving industrial property rights which may occur as a result of using the contents noted in this manual.

© 2005 MITSUBISHI ELECTRIC CORPORATION

1. Outline

This chapter explains computer link.

1.1 Outline of System

Computer link allows connection of up to sixteen FX PLCs and A PLCs to a personal computer working as the master station to link data.

- 1) Up to sixteen PLCs can be connected in computer link.
- 2) Protocols applicable in computer link are the same as dedicated protocols supported by computer link units in the A Series PLC. (But the supported formats and commands are limited.)

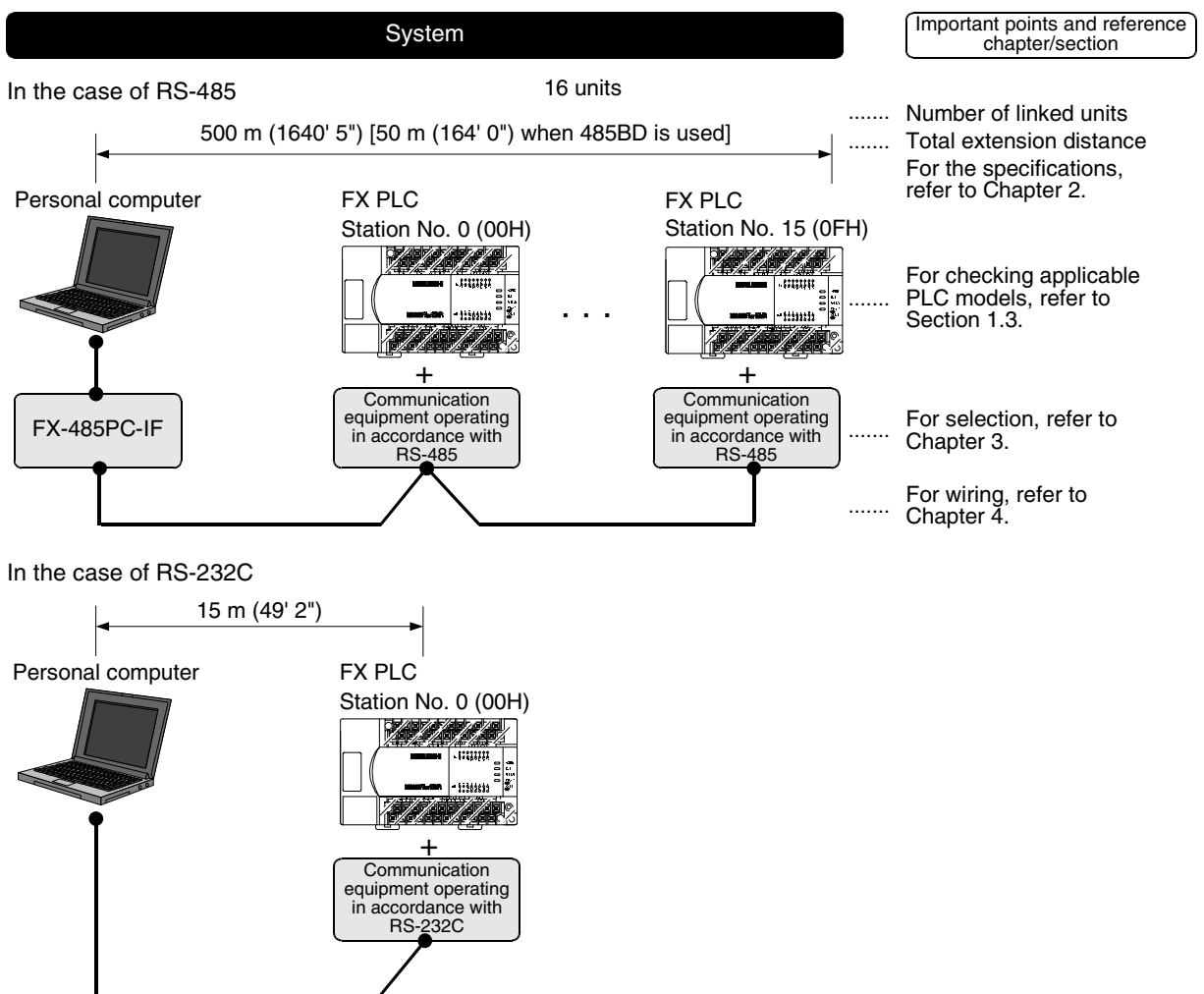

The number of devices handled at one time varies depending on the command and device types.

A	Common Items
B	N:N Network
C	Parallel Link
D	Computer Link
E	Inverter Communication
F	Non-Protocol Communication (RS/RS2 Instruction)
G	Non-Protocol Communication (FX2N-232IF)
H	Programming Communication
I	Remote Maintenance

1.2 Major Procedures until Operation

The flow chart below shows the procedures for setting computer link until data link.

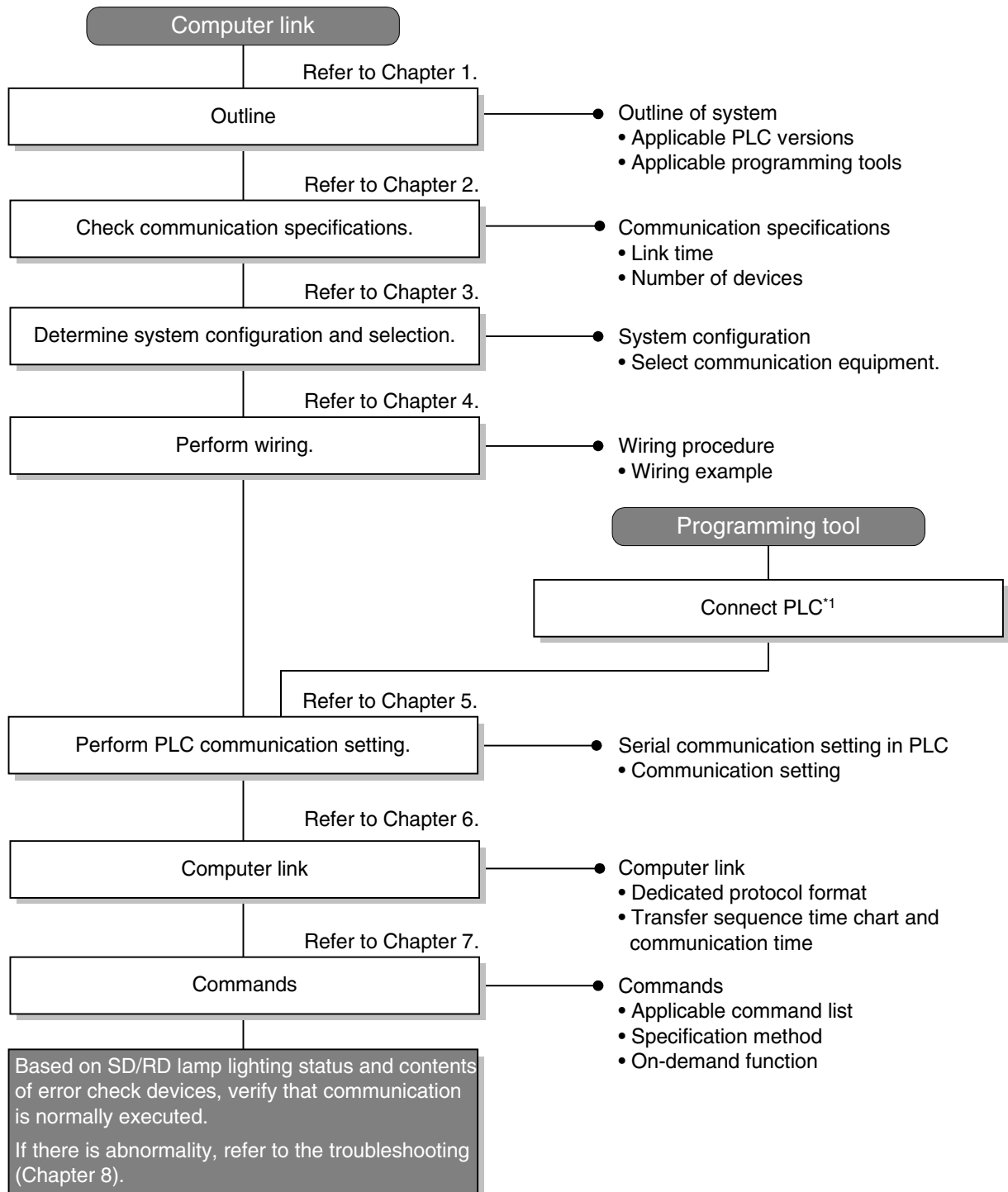

*1 For the method to connect a programming tool to a PLC, refer to the section "Programming Communication" in this manual or the manual of each programming tool.
 For details on operating procedures, refer to the manual of each programming tool.

1.3 Communication Type Applicability in PLC

1.3.1 Applicable versions

The communication type is applicable in the following versions.

✓: Applicable (If applicable versions are limited, they are described inside ().) —: Not applicable

PLC	Applicability (applicable version)	Remarks
FX3UC Series	✓	
FX3U Series	✓	
FX2NC Series	✓	
FX2N Series	✓ (Ver. 1.06 or later)	The version can be checked by monitoring D8001.
FX1NC Series	✓	
FX1N Series	✓	
FX1S Series	✓	
FX0N Series	✓ (Ver. 1.20 or later)	The version can be checked by monitoring D8001.
FX0S Series	—	Computer link is not provided.
FX0 Series	—	Computer link is not provided.
FX2C Series	✓ (Ver. 3.30 or later)*1	
FX2(FX) Series	✓ (Ver. 3.30 or later)*1	
FX1 Series	—	Computer link is not provided.

*1. Applicable in products manufactured in June, 1996 and later (manufacturer's serial No.: 66**** and later).

1. Version check

The D8001(decimal) special data register contains information for determining the PLC version.

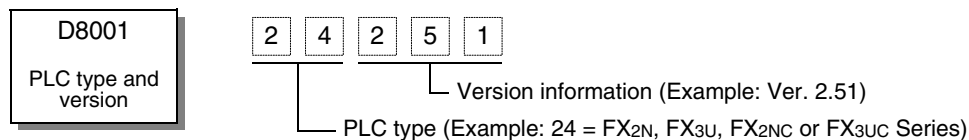

2. How to look at the manufacturer's serial number

The year and month of production of product can be seen from the Manufacturer's serial number "SERIAL" indicated on the label adhered to the right side of the product.

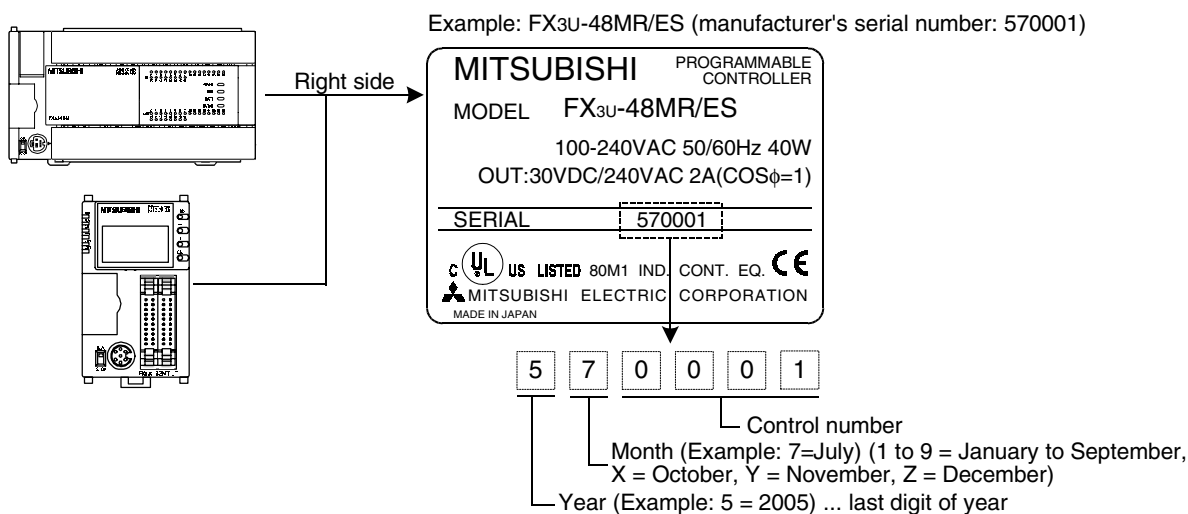

A	Common Items
B	N:N Network
C	Parallel Link
D	Computer Link
E	Inverter Communication
F	Non-Protocol Communication (RS/RS2 Instruction)
G	Non-Protocol Communication (FX2N-232IF)
H	Programming Communication
I	Remote Maintenance

1.3.2 Products whose production was stopped

The table below shows series in which production of the main unit, communication equipment, etc. is stopped.

Use the description on system configuration, etc. in this manual for maintenance.

PLC	Date when production was stopped	Remarks
FX0 Series	June 30, 2002	Maintenance is offered within 7 years from the end of production (until June 30, 2009).
FX2c Series		
FX2(FX) Series		
FX1 Series		

1.4 Programming Tool Applicability

1.4.1 For applicable versions

The programming tool is applicable in each FX Series from the following version:

1. Japanese versions

✓: Applicable (If applicable versions are limited, they are described inside ().) —: Not applicable

Model name (Media model name is shown below.)	Applicability (applicable version)	Remarks
FX3u and FX3uc PLCs		
GX Developer SW□D5C(F)-GPPW-J	✓ (Ver. SW8 P or later) Ver. 8.13P	Select the model "FX3UC".
FX2N and FX2NC PLCs		
GX Developer SW□D5C(F)-GPPW-J	✓ (Ver. SW2 A or later)	Select the model "FX2N/FX2NC".
FX-PCS/WIN SW0PC-FXGP/WIN	✓ (Ver. 2.00 or later)	
FX-PCS-KIT/98 SW1PC-FXGP/98(-3,-5)	✓ (Ver. 4.00 or later)	
FX-PCS/98-3 SW1PC-FXGP/98-3	✓ (Ver. 4.00 or later)	
FX-PCS-KIT/V-3 SW1-PC-FXGP/V3	✓ (Ver. 2.00 or later)	
FX-A7PHP-KIT SW1RX-GPPFX	✓ (Ver. 3.00 or later)	
FX-20P(-SET0) FX-20P-MFXC	✓ (Ver. 4.00 or later)	
FX-10P(-SET0)	✓ (Ver. 3.00 or later)	
GOT-F900 Series display units F940WGOT-TWD F940GOT-*WD F940GOT-*BD-H F940GOT-*BD-RH	✓ (Refer to right column.)	F940WGOT-TWD (Ver. 1.00 or later) F940GOT-LWD, F940GOT-SWD (Ver. 1.00 or later) F940GOT-LBD-H, F940GOT-SBD-H (Ver. 1.00 or later) F940GOT-LBD-RH, F940GOT-SBD-RH (Ver. 1.00 or later)

Model name (Media model name is shown below.)	Applicability (applicable version)	Remarks
FX1S, FX1N and FX1NC PLCs		
GX Developer SW□D5C(F)-GPPW-J	✓ (Ver. SW5 A or later)	Select the model "FX1S/FX1N".
FX-PCS/WIN SW0PC-FXGP/WIN	✓ (Ver. 4.00 or later)	
FX-PCS/98-3 SW1PC-FXGP/98-3	✓ (Ver. 5.00 or later)	
FX-20P(-SET0) FX-20P-MFXD	✓ (Ver. 5.00 or later)	
FX-10P(-SET0)	✓ (Ver. 4.00 or later)	
GOT-F900 Series display units F940WGOT-TWD F940GOT-*WD F940GOT-*BD-H F940GOT-*BD-RH	✓ (Refer to right column.)	F940WGOT-TWD (Ver. 1.00 or later) F940GOT-LWD, F940GOT-SWD (Ver. 1.00 or later) F940GOT-LBD-H, F940GOT-SBD-H (Ver. 1.00 or later) F940GOT-LBD-RH, F940GOT-SBD-RH (Ver. 1.00 or later)

2. English versions

✓: Applicable (If applicable versions are limited, they are described inside ().) —: Not applicable

Model name (Media model name is shown below.)	Applicability (applicable version)	Remarks
FX3u and FX3uc PLCs		
GX Developer SW□D5C(F)-GPPW-E	✓ (Ver. SW8 P or later) Ver. 8.13P	Select the model "FX3UC".
FX2N and FX2NC PLCs		
GX Developer SW□D5C(F)-GPPW-E	✓ (Ver. SW2 A or later)	Select the model "FX2N/FX2NC".
FX-PCS/WIN-E SW0PC-FXGP/WIN-E	✓ (Ver. 1.00 or later)	
FX-20P-E(-SET0) FX-20P-MFXC-E	✓ (Ver. 3.00 or later)	
FX-10P-E	✓ (Ver. 3.00 or later)	
GOT-F900 Series display units F940WGOT-TWD-E F940GOT-*WD-E F940GOT-*BD-H-E F940GOT-*BD-RH-E	✓ (Refer to right column.)	F940WGOT-TWD-E (Ver. 1.00 or later) F940GOT-LWD-E, F940GOT-SWD-E (Ver. 1.00 or later) F940GOT-LBD-H-E, F940GOT-SBD-H-E (Ver. 1.00 or later) F940GOT-LBD-RH-E, F940GOT-SBD-RH-E (Ver. 1.00 or later)
FX1S, FX1N and FX1NC PLCs		
GX Developer SW□D5C(F)-GPPW-E	✓ (Ver. SW5 A or later)	Select the model "FX1S/FX1N".
FX-PCS/WIN-E SW0PC-FXGP/WIN-E	✓ (Ver. 3.00 or later)	
FX-20P-E(-SET0) FX-20P-MFXD-E	✓ (Ver. 4.00 or later)	
FX-10P-E	✓ (Ver. 4.00 or later)	
GOT-F900 Series display units F940WGOT-TWD-E F940GOT-*WD-E F940GOT-*BD-H-E F940GOT-*BD-RH-E	✓ (Refer to right column.)	F940WGOT-TWD-E (Ver. 1.00 or later) F940GOT-LWD-E, F940GOT-SWD-E (Ver. 1.00 or later) F940GOT-LBD-H-E, F940GOT-SBD-H-E (Ver. 1.00 or later) F940GOT-LBD-RH-E, F940GOT-SBD-RH-E (Ver. 1.00 or later)

A Common Items
B N:N Network
C Parallel Link
D Computer Link
E Inverter Communication
F Non-Protocol Communication (RS/RSS2 Instruction)
G Non-Protocol Communication (FX2N-232IF)
H Programming Communication
I Remote Maintenance

1.4.2 For non-applicable versions (setting an alternative model)

Even software not applicable in a PLC can make programs when an alternative model is set. In this case, however, programming is enabled only in the ranges such as instructions and program size provided in the PLC selected as the alternative model.

Model to be programmed	Model to be set	Priority: High → Low			
FX3UC Series	FX3UC	→	FX2N	→	FX2(FX)
FX3U Series	FX3U, FX3UC	→	FX2N	→	FX2(FX)
FX2NC Series	FX2NC, FX2N	→	FX2(FX)		
FX2N Series	FX2N	→	FX2(FX)		
FX1NC Series	FX1NC, FX1N	→	FX2N	→	FX2(FX)
FX1N Series	FX1N	→	FX2N	→	FX2(FX)
FX1S Series	FX1S	→	FX2(FX)		
FX0N Series	FX0N	→	FX2(FX)		
FX0S Series	FX0S	→	FX2(FX)		
FX0 Series	FX0	→	FX2(FX)		
FX2C Series	FX2C, FX2	→	FX2(FX)		
FX2(FX) Series	FX2(FX)	→	FX2(FX)		
FX1 Series	FX1				

2. Specifications

This chapter explains the communication specifications and performance.

2.1 Communication Specifications (Reference)

Communication is executed in the specifications shown in the table below. The baud rate, etc. can be changed in the parameter settings in a programming tool or in a sequence program.

Item	Specifications	Remarks
Number of connectable units	16 maximum	
Transmission standard	RS-485 or RS-232C standard	
Maximum total extension distance	RS-485: 500 m (1640' 5") or less [50 m (164' 0") or less when 485BD is included in system] RS-232C: 15 m (49' 2") or less	Distance varies depending on communication equipment type.
Protocol type	Computer link (dedicated protocol)	Formats 1 and 4 are applicable.
Control procedure	—	
Communication method	Half-duplex, bidirectional communication	
Baud rate	300, 600, 1200, 2400, 4800, 9600 or 19200 bps	
Character format	—	
Start bit	Fixed	
Data bit	7 or 8-bit	
Parity bit	None, odd or even	
Stop bit	1 or 2-bit	
Header	Fixed	
Terminator	Fixed	
Control line	Fixed	
Sum check	Provided or not provided	

A	Common Items
B	N:N Network
C	Parallel Link
D	Computer Link
E	Inverter Communication
F	Non-Protocol Communication (RS/RS2 Instruction)
G	Non-Protocol Communication (FX2N-232IF)
H	Programming Communication
I	Remote Maintenance

2.2 Link Specifications

2.2.1 Applicable commands and number of device points

Name			Command		Contents of processing	Number of points processed in one-time update		
			Sym- bol	ASCII code		FX1s, FX0N	FX2(FX), FX2C, FX2N, FX1N, FX2NC, FX1NC	FX3U, FX3UC
Device memory	Batch reading	Unit: Bit	BR	42H, 52H	Reads bit devices in unit of 1 point.	54	256	256
		Unit: Word	WR	57H, 52H	Reads bit devices in unit of 16 points.	13 words 208 points	32 words 512 points	32 words 512 points
					Read word devices in unit of 1 point.	13 ^{*4}	64 ^{*2}	64 ^{*2}
			QR ^{*1}	51H, 52H	Reads bit devices in unit of 16 points.	—	—	32 words 512 points
	Read word devices in unit of 1 point.	—			—	64 ^{*2}		
	Batch writing	Unit: Bit	BW	42H, 57H	Writes bit devices in unit of 1 point.	46	160	160
		Unit: Word	WW	57H, 57H	Writes bit devices in unit of 16 points.	10 words 160 points	10 words 160 points	10 words 160 points
					Writes word devices in unit of 1 point.	11 ^{*5}	64 ^{*2}	64 ^{*2}
			QW ^{*1}	51H, 57H	Writes bit devices in unit of 16 points.	—	—	10 words 160 points
	Writes word devices in unit of 1 point.	—			—	64 ^{*2}		
	Test (random writing)	Unit: Bit	BT	42H, 54H	Specifies bit devices at random in unit of 1 point, and sets or resets them.	10	20	20
		Unit: Word	WT	57H, 54H	Specifies bit devices at random in unit of 16 points, and sets or resets them.	6 words 96 points	10 words 160 points	10 words 160 points
					Specifies word devices at random in unit of 1 point, and writes them.	6 ^{*3}	10 ^{*3}	10 ^{*3}
			QT ^{*1}	51H, 54H	Specifies bit devices at random in unit of 16 points, and sets or resets them.	—	—	10 words 160 points
Specifies word devices at random in unit of 1 point, and writes them.	—	—			10 ^{*3}			
PLC	Remote RUN	RR	52H, 52H	Requests remote RUN or remote STOP to PLC.	—	—	—	
	Remote STOP	RS	52H, 53H					
	PLC model name reading	PC	50H, 43H	Reads PLC model name.				
Global		GW	47H, 57H	Turns ON or OFF global signal (M8126 in FX Series) in all PLCs connected in computer link.	1	1	1	
On-demand		—	—	Set the sending request flag to ON in PLC (only when 1-to-1 connection is adopted in system configuration).	Maximum quantity specified in sequence program: 13 words	Maximum quantity specified in sequence program: 64 words	Maximum quantity specified in sequence program: 64 words	
Loop-back test		TT	54H, 54H	Returns characters received from computer as they are to computer.	25 characters	254 characters	254 characters	

- *1. Available only in FX3U and FX3UC PLCs.
- *2. 32 points when 32-bit counters (C200 to C255) are specified.
- *3. 32-bit counters (C200 to C255) are not applicable.
- *4. 6 points when 32-bit counters (C200 to C255) are specified.
- *5. 5 points when 32-bit counters (C200 to C255) are specified.

2.2.2 Applicable device ranges

The tables below show devices and device number ranges applicable in access to the device memory.

- Construct each of the BR, BW, BT, WR, WW, and WT commands in five characters.

$$\left(\begin{array}{c} \text{Device} \\ \text{1 character} \\ \text{2 characters for timer or counter} \end{array} \right) + \left(\begin{array}{c} \text{Device number} \\ \text{4 characters} \\ \text{3 characters for timer or counter} \end{array} \right) = 5 \text{ characters}$$

- Construct each of the QR, QW, and QT commands in seven characters.

$$\left(\begin{array}{c} \text{Device} \\ \text{1 character} \\ \text{2 characters for timer or counter} \end{array} \right) + \left(\begin{array}{c} \text{Device number} \\ \text{6 characters} \\ \text{5 characters for timer or counter} \end{array} \right) = 7 \text{ characters}$$

1. Bit devices

FX PLCs do not support timer coils (TC) and counter coils (CC).

Device	Device number range (character)						Device number expression Decimal/ Octagon	Available commands		
	FX1S	FX0N	FX2(FX), FX2C	FX1N, FX1NC	FX2N, FX2NC	FX3U, FX3UC		BR, BW, BT	WR, WW, WT	QR, QW, QT
Input relay (X)	X0000 to X0017	X0000 to X0177	X0000 to X0267	X0000 to X0177	X0000 to X0337	X0000 to X0377	Octagon	✓	✓	—
	—					X000000 to X000377		—	—	✓
Output relay (Y)	Y0000 to Y0015	Y0000 to Y0177	Y0000 to Y0267	Y0000 to Y0177	Y0000 to Y0337	Y0000 to Y0377		✓	✓	—
	—					Y000000 to Y000377		—	—	✓
Auxiliary relay (M)	M0000 to M0511		M0000 to M1535		M0000 to M3071	M0000 to M7679	Decimal	✓	✓	—
	—					M000000 to M007679		—	—	✓
State relay (S)	S0000 to S0127		S0000 to S0999			S0000 to S4095		✓	✓	—
	—					S000000 to S004095		—	—	✓
Special auxiliary relay (M)	M8000 to M8254		M8000 to M8255			M8000 to M8511	Decimal	✓	✓	—
	—					M008000 to M008511		—	—	✓
Timer contact (T)	TS000 to TS063		TS000 to TS255			TS000 to TS511		✓	—	—
	—					TS00000 to TS00511		—	—	—
Counter contact (C)	CS000 to CS031	CS000 to CS031	CS000 to CS255			CS000 to CS255	Decimal	✓	—	—
	CS235 to CS255	CS235 to CS254				CS00000 to CS00255		—	—	
—					CS00000 to CS00255	—		—	—	

2. Word devices

Device	Device number range (character)						Device number expression Decimal/ Octagon	Available commands		
	FX1S	FX0N	FX2(FX), FX2C	FX1N, FX1NC	FX2N, FX2NC	FX3U, FX3UC		BR, BW, BT	WR, WW, WT	QR, QW, QT
Timer current value (T)	TN000 to TN063		TN000 to TN255			TN000 to TN511	Decimal	—	✓	—
	—					TN00000 to TN00511			—	✓
Counter current value (C)	CN000 to CN031 CN235 to CN255	CN000 to CN031 CN235 to CN254	CN000 to CN255			CN000 to CN255			✓*1	—
	—					CN00000 to CN00255			—	✓*1
Data register (D)	D0000 to D0255		D0000 to D0999	D0000 to D7999		D0000 to D7999			✓	—
	—					D000000 to D007999			—	✓
File register (D)	—	D1000 to D2499	D1000 to D2999	—		—			✓	—
	—					—			—	—
RAM file register (D)	—		D6000 to D7999	—		—			✓	—
	—					—			—	—
Extension register (R)	—					R0000 to R9999	✓	—		
	—					R000000 to R032767	—	✓		
Special data register (D)	D8000 to D8255		D8000 to D8255			D8000 to D8511	✓	—		
	—					D008000 to D008511	—	✓		

*1. The WT and QT commands do not support 32-bit counters (C200 to C255).

Cautions

- When using bit devices in a command requiring specification in units of word, make sure that the head device number is a multiple of "8".
- Special auxiliary relays and special data registers are classified into ones only for reading, ones only for writing and ones for system.
If data is written to any range in which writing is not allowed, an error may occur in the PLC.
For details on special auxiliary relays and special data registers, refer to the manual of the PLC.
- In FX1S, FX1N, FX2N, FX3U, FX1NC, FX2NC and FX3UC PLCs, it is disabled to access data in the program area (in the built-in RAM and memory cassette) when file registers (D) are set.
In FX3U and FX3UC PLCs, extension registers (R) cannot access extension file registers (ER) in a mounted memory cassette.

2.2.3 Link time

1. Data transfer

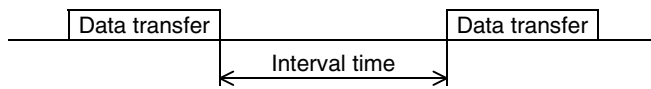

2. Data transfer time

Time to read continuous word devices (timers, counters or data registers) in one station = $(21^{*1} + 4 \times \text{Number of read points}^{*2}) \times \text{Time to send or receive 1 character (ms)} + \text{Interval time} + \text{Maximum scan time (special data register D8012) in PLC} \times 3 + \text{Message waiting time}$

Time to write continuous word devices (timers, counters or data registers) in one station = $(20^{*1} + 4 \times \text{Number of written points}^{*2}) \times \text{Time to send or receive 1 character (ms)} + \text{Interval time} + \text{Maximum scan time (special data register D8012) in PLC} + \text{Message waiting time}$

- *1. This is the number of characters when the protocol format 1 is used and the sum check is not provided.
When the protocol format 4 is used, add "4" to this value.
When the sum check is provided, add "4" to this value also.
- *2. The number of points is counted in units of word.

3. Time to send or receive one character

The table below shows the time required to send or receive one character when the start bit is 1-bit, the data length is 7-bit, the parity is 1-bit, and the stop bit is 1-bit.

Transmission speed (baud rate) (bps)	Time to send or receive 1 character (ms)
300	33.34
600	16.67
1200	8.34
2400	4.17
4800	2.08
9600	1.04
19200	0.52

The tables below show the data transfer times depending on the number of continuous read or written word devices at the transmission speeds of 9600 bps and 19200 bps when the message waiting time is 0 ms^{*1}, the maximum scan time is 20 ms, and the interval time is 100 ms.

<When the transmission speed is 9600 bps> Unit: sec

Amount of data points	Number of stations		
	1	8	16
10	0.3	1.9	3.7
32	0.4	2.6	5.2
64	0.5	3.7	7.3

<When the transmission speed is 19200 bps> Unit: sec

Amount of data points	Number of stations		
	1	8	16
10	0.2	1.6	3.2
32	0.3	2.0	3.9
64	0.4	2.5	5.0

When the types of read or written devices increase, "Data transfer time shown in above table × Number of device types" is required.

When the number of read or written points exceeds "64"^{*2}, the number of transfer times increases. Accordingly, for achieving efficient data transfer, it is recommended to decrease the types of transferred devices and use as many continuous device numbers as possible.

- *1. The message waiting time is "0" when the RS-485 interface and two-pair wiring are used.
The message waiting time is "0" also when the RS-232C interface is used.
When the one-pair wiring is adopted, the message waiting time of 70 to 150 ms is required in each transfer. Add this message waiting time.
- *2. The maximum number of points is 64 in the FX2(FX), FX2C, FX1N, FX2N, FX3U, FX1NC, FX2NC and FX3UC Series. The maximum number of points is as follows in the FX0N and FX1S Series:
Maximum number of read points: 13
Maximum number of written points: 11

A	Common Items
B	N:N Network
C	Parallel Link
D	Computer Link
E	Inverter Communication
F	Non-Protocol Communication (RS/RS2 Instruction)
G	Non-Protocol Communication (FX2N-232IF)
H	Programming Communication
I	Remote Maintenance

3. System Configuration and Equipment Selection

This chapter explains the system configuration and selection of communication equipment operating in accordance with RS-485 or RS-232C required by FX PLCs.

3.1 System Configuration

This section explains the outline of system configuration required to use computer link. Connect (optional) equipment operating in accordance with RS-485 or RS-232C to the FX PLC main unit.

1, **2** and **3** indicate the pattern types of combination of communication equipment.

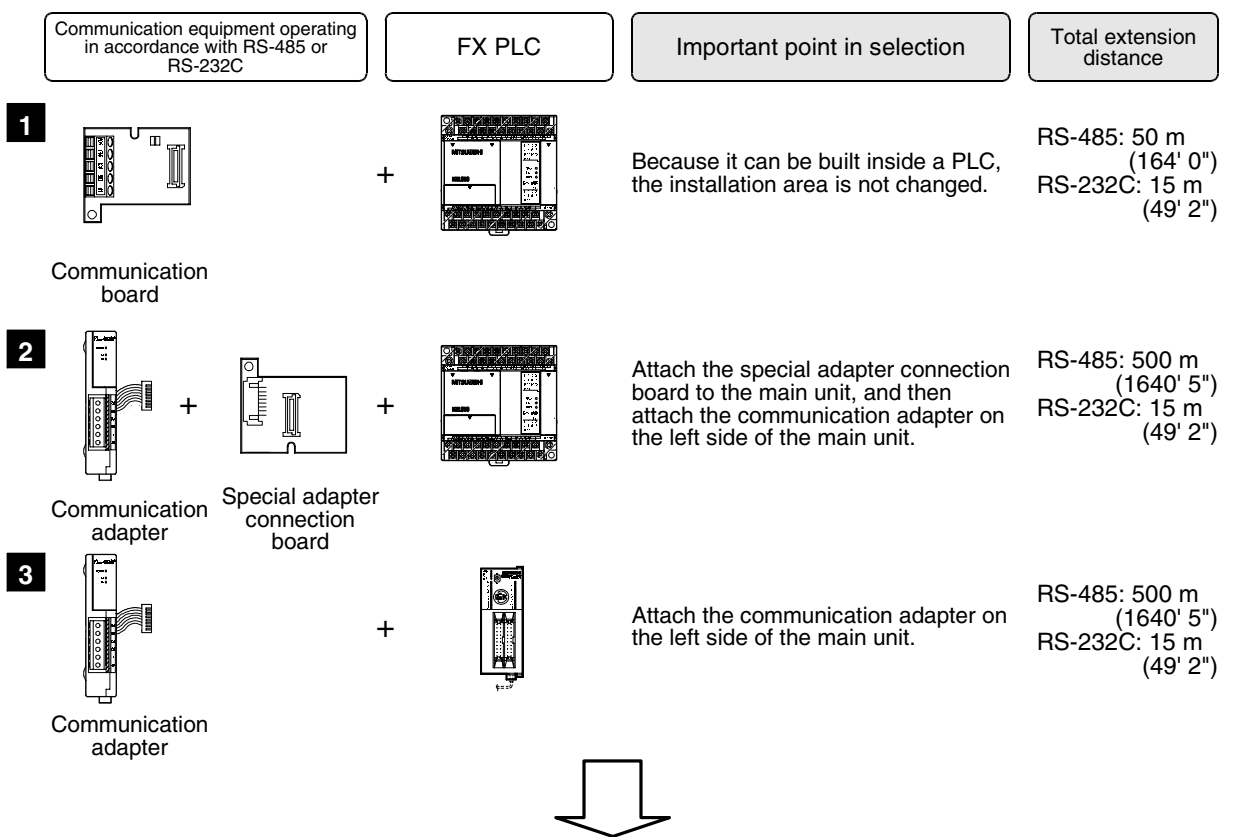





For combinations of communication equipment for each FX Series, refer to the next page.

3.2 Applicable FX PLC and Communication Equipment

Select a combination of (optional) communication equipment, and put a check mark in the "Check" column. In selection, pay attention to the following:

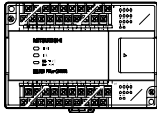
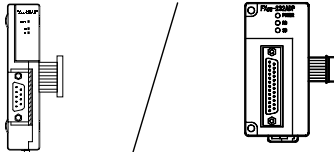

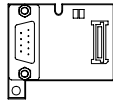

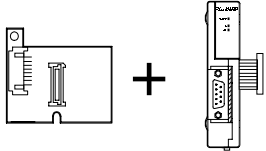
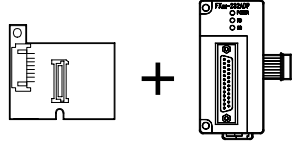
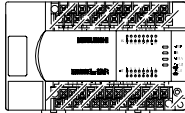
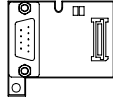
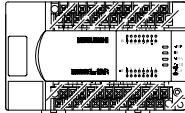
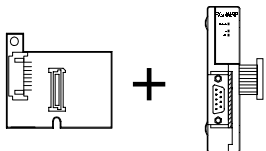
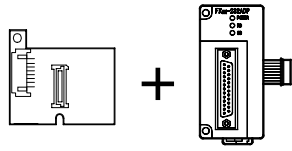
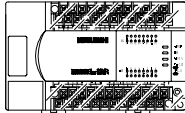
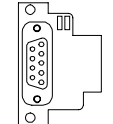
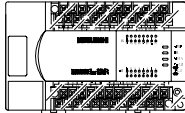
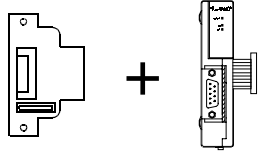
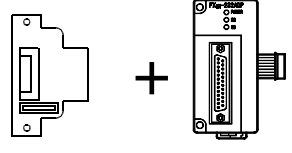
- Computer link is not provided in the FX0, FX0S, FX1 Series.

3.2.1 For communication in accordance with RS-232C

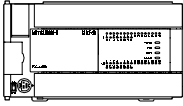
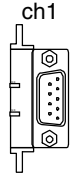
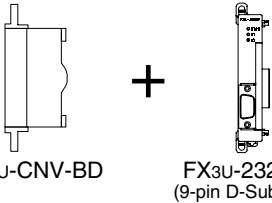
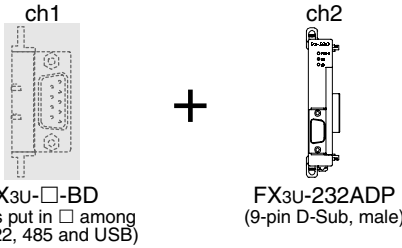
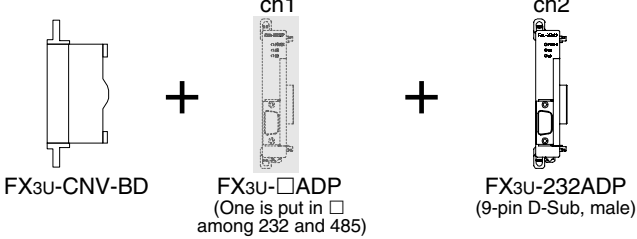
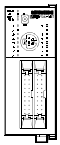
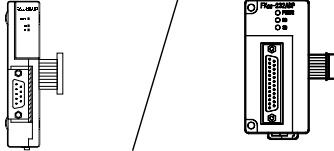
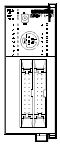
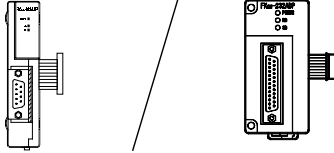
FX Series	Communication equipment (option)	Total extension distance	Check
 FX0N	 FX2NC-232ADP (9-pin D-Sub, male) / FX0N-232ADP (25-pin D-Sub, female)	15 m (49' 2")	
 FX1S	 FX1N-232-BD (9-pin D-Sub, male)	15 m (49' 2")	
 FX1N	 +  FX1N-CNV-BD / FX2NC-232ADP (9-pin D-Sub, male) / FX1N-CNV-BD / FX0N-232ADP (25-pin D-Sub, female)	15 m (49' 2")	
 FX2N	 FX1N-232-BD (9-pin D-Sub, male)	15 m (49' 2")	
 FX2N	 +  FX1N-CNV-BD / FX2NC-232ADP (9-pin D-Sub, male) / FX1N-CNV-BD / FX0N-232ADP (25-pin D-Sub, female)	15 m (49' 2")	
 FX2N	 FX2N-232-BD (9-pin D-Sub, male)	15 m (49' 2")	
 FX2N	 +  FX2N-CNV-BD / FX2NC-232ADP (9-pin D-Sub, male) / FX2N-CNV-BD / FX0N-232ADP (25-pin D-Sub, female)	15 m (49' 2")	

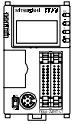
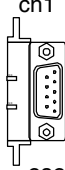
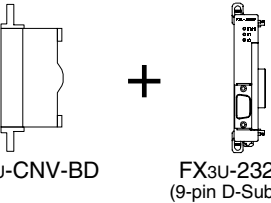
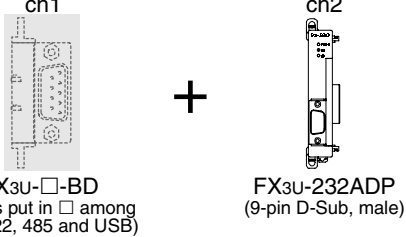
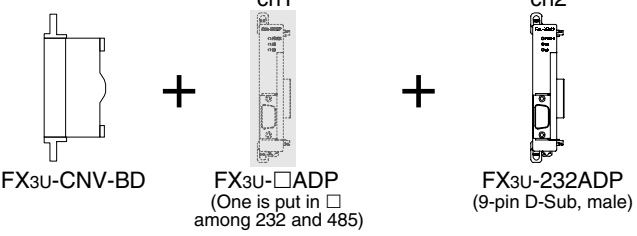
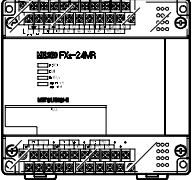

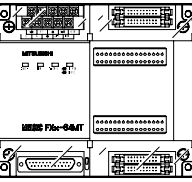



A	Common Items
B	N:N Network
C	Parallel Link
D	Computer Link
E	Inverter Communication
F	Non-Protocol (RS/RSS2 Instruction)
G	Non-Protocol Communication (FX2N-232IF)
H	Programming Communication
I	Remote Maintenance



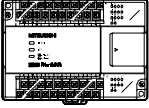
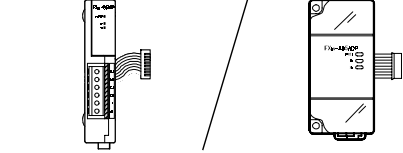

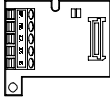

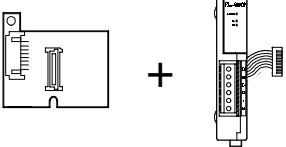
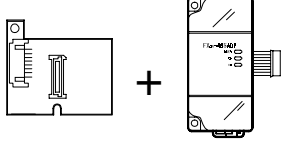
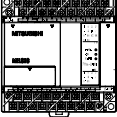
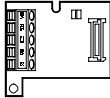
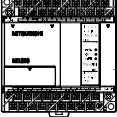
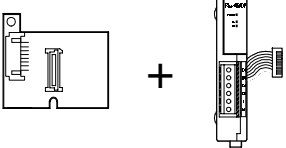
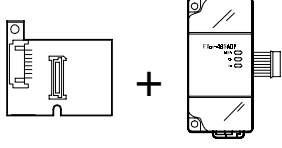
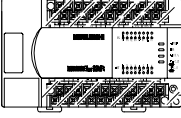
FX Series	Communication equipment (option)	Total extension distance	Check
 <p>FX3U</p>	<p>When using channel 1 (ch 1)</p>		
	 <p>ch1 FX3U-232-BD (9-pin D-Sub, male)</p>	<p>15 m (49' 2")</p>	
	 <p>FX3U-CNV-BD + FX3U-232ADP (9-pin D-Sub, male)</p>	<p>15 m (49' 2")</p>	
	<p>When using channel 2 (ch 2)</p>		
	 <p>ch1 + ch2 FX3U-□-BD (One is put in □ among 232, 422, 485 and USB) + FX3U-232ADP (9-pin D-Sub, male)</p>	<p>15 m (49' 2")</p>	
	 <p>FX3U-CNV-BD + FX3U-□-ADP (One is put in □ among 232 and 485) + FX3U-232ADP (9-pin D-Sub, male)</p>	<p>15 m (49' 2")</p>	
	 <p>FX1NC</p>	 <p>FX2NC-232ADP (9-pin D-Sub, male) / FX0N-232ADP (25-pin D-Sub, female)</p>	<p>15 m (49' 2")</p>
 <p>FX2NC</p>	 <p>FX2NC-232ADP (9-pin D-Sub, male) / FX0N-232ADP (25-pin D-Sub, female)</p>	<p>15 m (49' 2")</p>	

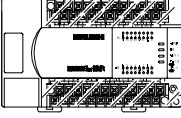
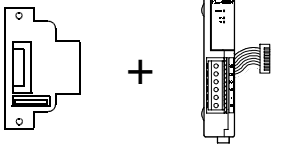
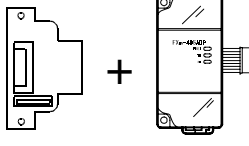
FX Series	Communication equipment (option)	Total extension distance	Check
 <p>FX3UC</p>	When using channel 1 (ch 1)		
	 <p>ch1 FX3U-232-BD (9-pin D-Sub, male)</p>	15 m (49' 2")	
	 <p>FX3U-CNV-BD + FX3U-232ADP (9-pin D-Sub, male)</p>	15 m (49' 2")	
	When using channel 2 (ch 2)		
	 <p>ch1 + ch2 FX3U-□-BD (One is put in □ among 232, 422, 485 and USB) FX3U-232ADP (9-pin D-Sub, male)</p>	15 m (49' 2")	
	 <p>FX3U-CNV-BD + FX3U-□-ADP + FX3U-232ADP (One is put in □ among 232 and 485) (9-pin D-Sub, male)</p>	15 m (49' 2")	
FX Series	Communication equipment (option)	Total extension distance	Check
 <p>FX2(FX)</p>	 <p>FX-232ADP (25-pin D-Sub, female)</p>	15 m (49' 2")	
 <p>FX2C</p>	 <p>FX-232ADP (25-pin D-Sub, female)</p>	15 m (49' 2")	

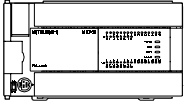
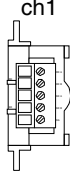
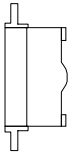



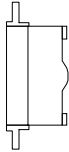

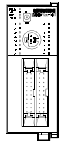
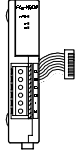
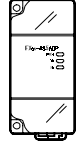
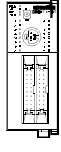
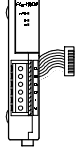
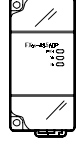

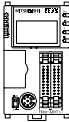
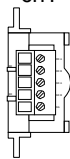

A	Common Items
B	N:N Network
C	Parallel Link
D	Computer Link
E	Inverter Communication
F	Non-Protocol Communication (RS/RSS2 Instruction)
G	Non-Protocol Communication (FX2N-232IF)
H	Programming Communication
I	Remote Maintenance

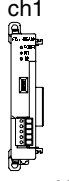
3.2.2 For communication in accordance with RS-485.

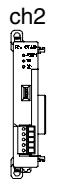
FX Series	Communication equipment (option)	Total extension distance	Check
 FX0N	 FX2NC-485ADP (European terminal block) / FX0N-485ADP (Terminal block)	500 m (1640' 5")	
 FX1S	 FX1N-485-BD (European terminal block)	50 m (164' 0")	
 FX1S	 +  FX1N-CNV-BD (European terminal block) / FX2NC-485ADP (European terminal block) / FX1N-CNV-BD (European terminal block) / FX0N-485ADP (Terminal block)	500 m (1640' 5")	
 FX1N	 FX1N-485-BD (European terminal block)	50 m (164' 0")	
 FX1N	 +  FX1N-CNV-BD (European terminal block) / FX2NC-485ADP (European terminal block) / FX1N-CNV-BD (European terminal block) / FX0N-485ADP (Terminal block)	500 m (1640' 5")	
 FX2N	 FX2N-485-BD	50 m (164' 0")	
 FX2N	 +  FX2N-CNV-BD (European terminal block) / FX2NC-485ADP (European terminal block) / FX2N-CNV-BD (European terminal block) / FX0N-485ADP (Terminal block)	500 m (1640' 5")	

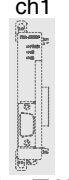
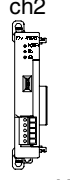
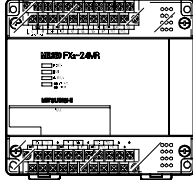
FX Series	Communication equipment (option)	Total extension distance	Check	
When using channel 1 (ch 1)				
 <p>FX3U</p>	 <p>ch1</p> <p>FX3U-485-BD (European terminal block)</p>	50 m (164' 0")		
	 <p>FX3U-CNV-BD</p> <p>+</p>  <p>ch1</p> <p>FX3U-485ADP (European terminal block)</p>	500 m (1640' 5")		
	When using channel 2 (ch 2)			
	 <p>ch1</p> <p>FX3U-□-BD (One is put in □ among 232, 422, 485, and USB).</p> <p>+</p>  <p>ch2</p> <p>FX3U-485ADP (European terminal block)</p>	500 m (1640' 5")		
 <p>FX3U-CNV-BD</p> <p>+</p>  <p>ch1</p> <p>FX3U-□-ADP (One is put in □ among 232 and 485).</p> <p>+</p>  <p>ch2</p> <p>FX3U-485ADP (European terminal block)</p>	500 m (1640' 5")			
 <p>FX1NC</p>	 <p>FX2NC-485ADP (European terminal block)</p> <p>/</p>  <p>FX0N-485ADP (Terminal block)</p>	500 m (1640' 5")		
 <p>FX2NC</p>	 <p>FX2NC-485ADP (European terminal block)</p> <p>/</p>  <p>FX0N-485ADP (Terminal block)</p>	500 m (1640' 5")		

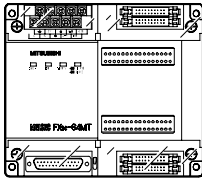
A	Common Items
B	N:N Network
C	Parallel Link
D	Computer Link
E	Inverter Communication
F	Non-Protocol Communication (RS/RS2 Instruction)
G	Non-Protocol Communication (FX2N-232IF)
H	Programming Communication
I	Remote Maintenance

FX Series	Communication equipment (option)	Total extension distance	Check	
 FX3UC	When using channel 1 (ch 1)			
	 ch1 FX3U-485-BD (European terminal block)	50 m (164' 0")		
	  + FX3U-CNV-BD FX3U-485ADP (European terminal block)	500 m (1640' 5")		
	When using channel 2 (ch 2)			
	 ch1 FX3U-□-BD (One is put in □ among 232, 422, 485, and USB).	 ch2 FX3U-485ADP (European terminal block)	500 m (1640' 5")	
	  + FX3U-CNV-BD FX3U-□-ADP (One is put in □ among 232 and 485).	 ch2 FX3U-485ADP (European terminal block)	500 m (1640' 5")	
FX Series	Communication equipment (option)	Total extension distance	Check	
 FX2	 FX-485ADP (Terminal block)	500 m (1640' 5")		
 FX2C	 FX-485ADP (Terminal block)	500 m (1640' 5")		

4. Wiring

This chapter explains the wiring.

WIRING PRECAUTIONS



- Cut off all phases of the power source externally before installation or wiring work in order to avoid electric shock or damage of product.
- Make sure to attach the terminal cover offered as an accessory to the product before turning on the power or starting the operation after installation or wiring work.
 Failure to do so may cause electric shock.

WIRING PRECAUTIONS



- Make sure to observe the precautions below in order to prevent any damage to the machine or any accident which may be caused by abnormal data written to the PLC due to the influence of noise:
 - 1) Do not lay close or bundle with the main circuit line, high-voltage line, or load line.
 Otherwise, effects of noise or surge induction are likely to take place.
 Keep a safe distance of least 100 mm (3.94") from the above lines during wiring.
 - 2) Ground the shield wire or shield of a shielded cable at one point on the PLC. However, do not ground at the same point as high voltage lines.
- Perform wiring properly to the FX0N/FX2N Series extension equipment of the terminal block type in accordance with the precautions below.
 Failure to do so may cause electric shock, short-circuit, wire breakage, or damages to the product.
 - The disposal size of the cable end should follow the dimensions described in this manual.
 - Tightening torque should follow the torque described in this manual.
- Observe the following items to wire the lines to the European terminal board. Ignorance of the following items may cause electric shock, short circuit, disconnection, or damage of the product.
 - The disposal size of the cable end should follow the dimensions described in this manual.
 - Tightening torque should follow the torque described in this manual.
 - Twist the end of strand wire and make sure there is no loose wires.
 - Do not solder-plate the electric wire ends.
 - Do not connect electric wires of unspecified size or beyond the specified number of electric wires.
 - Fix the electric wires so that the terminal block and connected parts of electric wires are not directly stressed.

A

Common Items

B

N:N Network

C

Parallel Link

D

Computer Link

E

Inverter Communication

F

Non-Protocol Communication (RS/RS2 Instruction)

G

Non-Protocol Communication (FX2N-232IF)

H

Programming Communication

I

Remote Maintenance

4.1 Wiring Procedure

1 Selecting the connection method

Select the wiring method suitable to the application.

→ For details, refer to Section 4.2.

2 Preparing for wiring

Prepare cables and terminal resistors required in the wiring.

→ For details, refer to Section 4.3.

3 Turning OFF the PLC power

Before starting the wiring work, make sure that the PLC power is OFF.

4 Connecting the power supply (only the FX0N-485ADP)

Connect the power supply to the 24V DC power terminal.

5 Wiring communication equipment

Connect communication equipment operating in accordance with RS-485 or RS-232C.

→ For the communication in accordance with RS-232C, refer to Section 4.4.

→ For the communication in accordance with RS-485, refer to Section 4.5.

4.2 Selecting Connection Method

When using computer link, communication can be achieved in accordance with RS-232C or RS-485 (422). In FX3U and FX3UC PLCs, computer link is applicable in up to two channels at the same time. In such a case, communication can be achieved in accordance with RS-232C in both channels, in accordance with RS-485 in both channels, or in accordance with RS-232C in one channel and RS-485 in the other channel.

4.2.1 For communication in accordance with RS-232C (1-to-1 connection)

In the communication in accordance with RS-232C, 1-to-1 connection is applicable. Make sure that the total extension distance is 15 m (49' 2") or less.

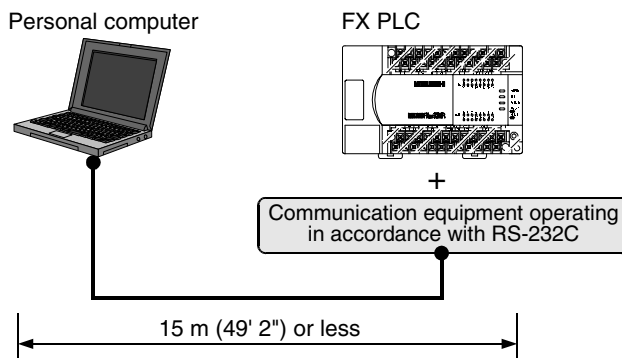

4.2.2 For communication in accordance with RS-485 (RS-422) (1-to-N connection)

In the communication in accordance with RS-485 (RS-422), up to 16 PLCs can be connected. Make sure that the total extension distance is 500 m (1640' 5") or less [50 m (164' 0") or less when 485BD is included].

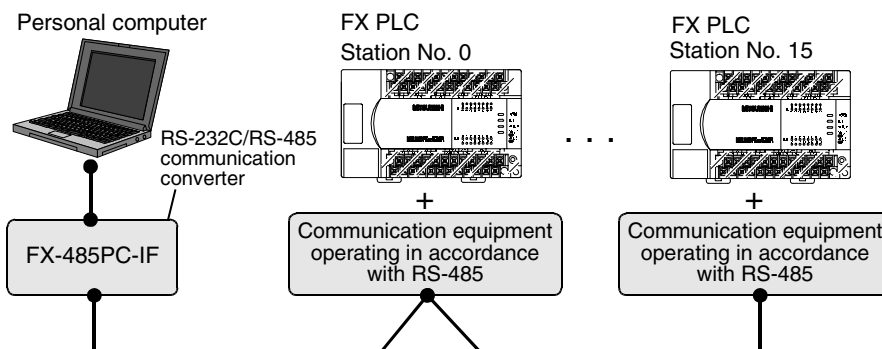

One-pair wiring and two-pair wiring are applicable in the communication in accordance with RS-485 (RS-422). The wiring method is determined for each application. Refer to the table below, and perform suitable wiring.

		One-pair wiring	Two-pair wiring
Computer link ^{*1}	When the message waiting time ^{*2} should be 70 ms or less	—	✓
	When the message waiting time ^{*2} may be more than 70 ms	⊙ ^{*3}	✓
	When the on-demand function is used	—	✓

⊙: Recommended wiring method, ✓: Applicable wiring method, —: Non-applicable wiring method

- *1. When computer link is added to an existing system, adopt the wiring method used in the existing system.
- *2. For the message waiting time, refer to Subsection 6.4.3.
- *3. "Echo transfer" is generated when the FX-485PC-IF is used in the one-pair wiring. Take proper countermeasures in the computer so that the echo transfer can be ignored.

A	Common Items
B	N:N Network
C	Parallel Link
D	Computer Link
E	Inverter Communication
F	Non-Protocol Communication (RS/RS2 Instruction)
G	Non-Protocol Communication (FX2N-232IF)
H	Programming Communication
I	Remote Maintenance

4.3 Selecting Cables and Terminal Resistors (RS-485)

Select cables using the procedure described below.

4.3.1 Twisted pair cable

Use shielded twisted pair cables for connecting communication equipment operating in accordance with RS-485.

The table below shows recommended model names and manufacturers of cables used in wiring.

1. Recommended cables

Manufacturer	Model name	Remarks
Mitsubishi Cable Industries, Ltd.	SPEV(SB)-0.2-2P	Two-pair cable of 0.2 mm ²
	SPEV(SB)-MPC-0.2 × 3P	Three-pair cable of 0.2 mm ²
	SPEV(SB)-0.5-2P	Two-pair cable of 0.5 mm ²
Showa Electric Wire & Cable Co., Ltd.	KMPEV-SB CWS-178 0.2SQ × 2P	Two-pair cable of 0.2 mm ²
	KMPEV-SB CWS-178 0.5SQ × 2P	Two-pair cable of 0.5 mm ²
Sumitomo Electric Industries, Ltd.	DPEV SB 0.3 × 3P	Three-pair cable of 0.3 mm ²
	DPEV SB 0.5 × 3P	Three-pair cable of 0.5 mm ²
The Furukawa Electric Co., Ltd.	D-KPEV-SB 0.2 × 3P	Three-pair cable of 0.2 mm ²
	D-KPEV-SB 0.5 × 3P	Three-pair cable of 0.5 mm ²
Fujikura Ltd.	IPEV-SB 2P × 0.3 mm ²	Two-pair cable of 0.3 mm ²
	IPEV-SB 2P × 0.5 mm ²	Two-pair cable of 0.5 mm ²

2. Cable structural drawing (reference)

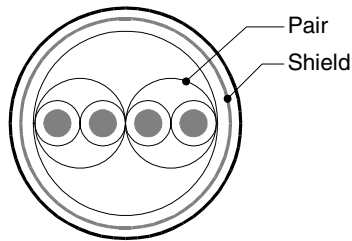

Example of two-pair cable structural drawing

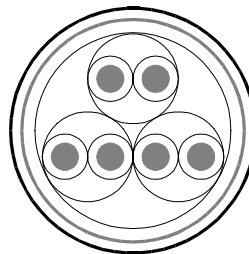

Example of three-pair cable structural drawing

4.3.2 Connecting cables

1. European type terminal block

Use shielded twisted pair cables for connecting communication equipment operating in accordance with RS-485.

The table below shows applicable cables and tightening torque.

	Cable size when one cable is connected	Cable size when two cables are connected	Cable size for bar terminal with insulating sleeve	Tightening torque	Tool size	
					A	B
FX3U-485-BD FX3U-485ADP	AWG22 to AWG20	AWG22	AWG22 to AWG20	0.22 to 0.25 N·m	0.4 (0.01")	2.5 (0.09")
FX2N-485-BD FX1N-485-BD	AWG26 to AWG16		—	0.6 N·m	0.6 (0.03")	3.5 (0.14")
FX2NC-485ADP	AWG26 to AWG16	AWG26 to AWG20	—	0.4 to 0.5 N·m	0.6 (0.03")	3.5 (0.14")

With regard to the cable end treatment, treat a stranded cable or solid cable as it is, or use a bar terminal with insulating sleeve.

- When treating a stranded cable or solid cable as it is
 - Twist the end of a stranded cable so that wires don't get barbed.
 - Do not plate the end of a cable.

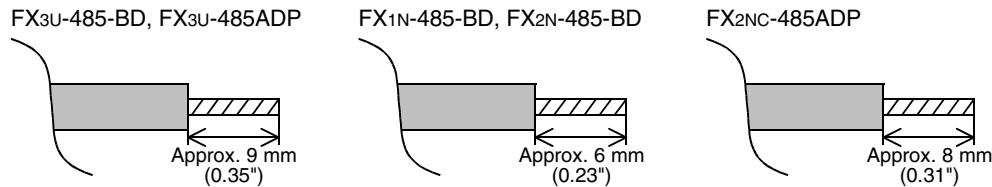

- When using a bar terminal with insulating sleeve
Because it is difficult to insert a cable into an insulating sleeve depending on the cable sheath thickness, select a proper cable according to the outline drawing.

Manufacturer	Model name	Caulking tool
Phoenix Contact	AI 0.5-8WH	CRIMPFOX UD6

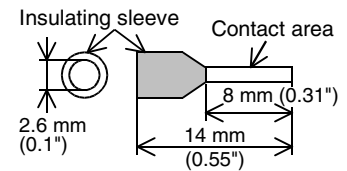

- Tool
 - When tightening a terminal on the European terminal block, use a small commercial screwdriver having straight shape whose tip is not wide as shown in the right figure.

Manufacturer	Model name
Phoenix Contact	SZS 0.4 × 2.5

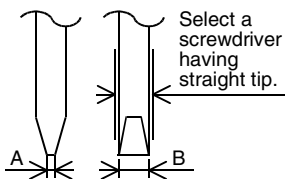

For the size A and size B, refer to the above table.

2. Terminal block

In the FX0N-485ADP and FX-485ADP, the terminal screw size is "M3". Make sure to use a crimp-style terminal having the following sizes. Make sure that the tightening torque is 0.5 to 0.8 N·m.

- When wiring one cable to one terminal

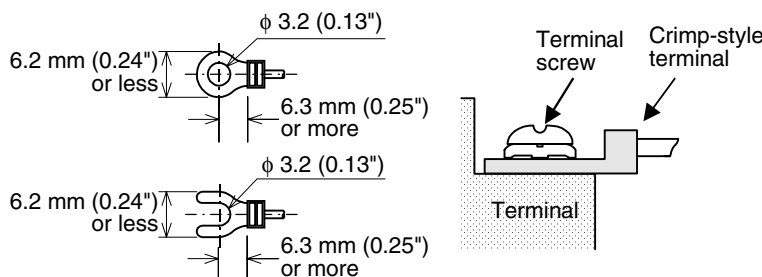

- When wiring two cables to one terminal

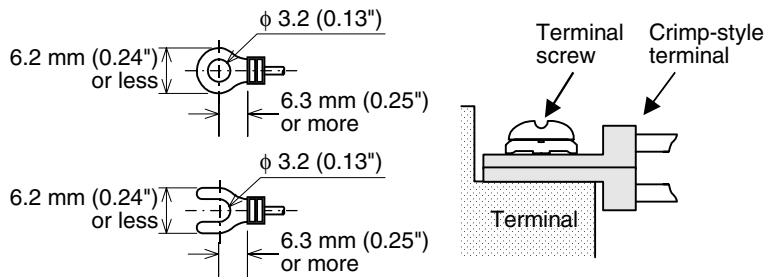

4.3.3 Connecting terminal resistors

Make sure to provide a terminal resistor at each end of a line.

In the case of one-pair wiring, connect a terminal resistor to the RDA-RDB signal terminal in the communication equipment.

In the case of two-pair wiring, connect a terminal resistor to the RDA-RDB signal terminal and SDA-SDB terminal in the communication equipment.

1. Terminal resistor type

In the case of one-pair wiring, use two terminal resistors of 110 Ω, 1/2 W.

In the case of two-pair wiring, use four terminal resistors of 330 Ω, 1/4 W.

Among terminal resistors supplied together with the communication equipment, select ones having the color codes shown on the right.

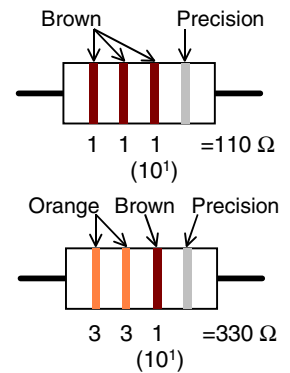

2. When using the FX3U-485-BD or FX3U-485ADP

The FX3U-485-BD and FX3U-485ADP have a built-in terminal resistor.

Set the terminal resistor selector switch accordingly.

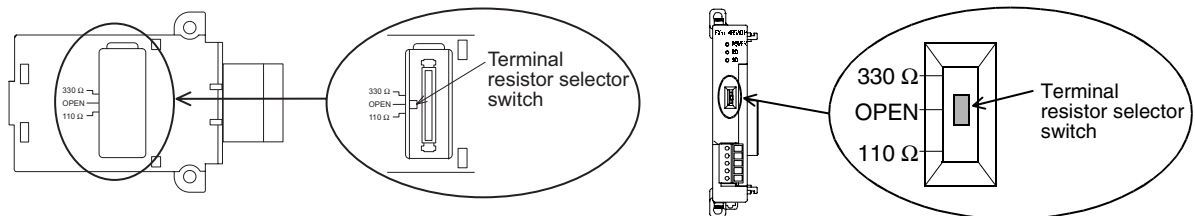

4.4 Connection Diagram for RS-232C

Representative wiring examples are shown in this section. When pin numbers in the counterpart equipment are different, wire the pins as shown below.

4.4.1 Connection diagram between FX PLC and personal computer

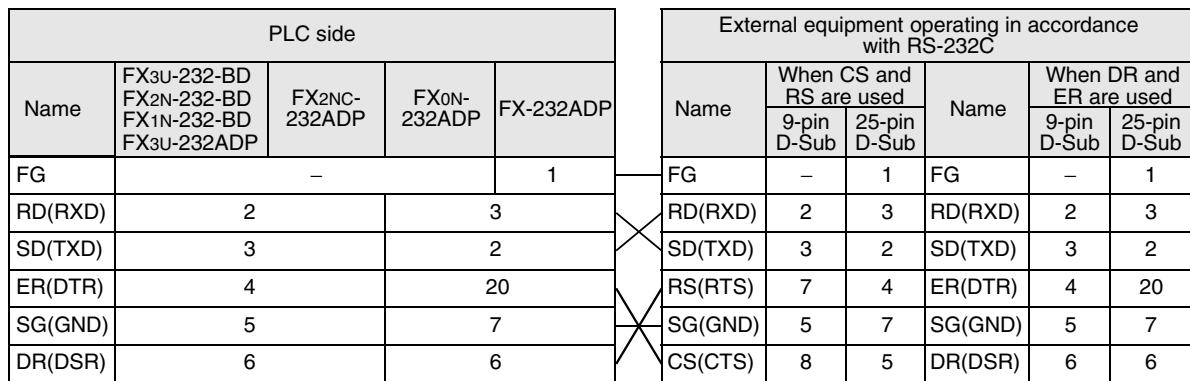

4.4.2 Connection diagram between FX-485PC-IF and personal computer

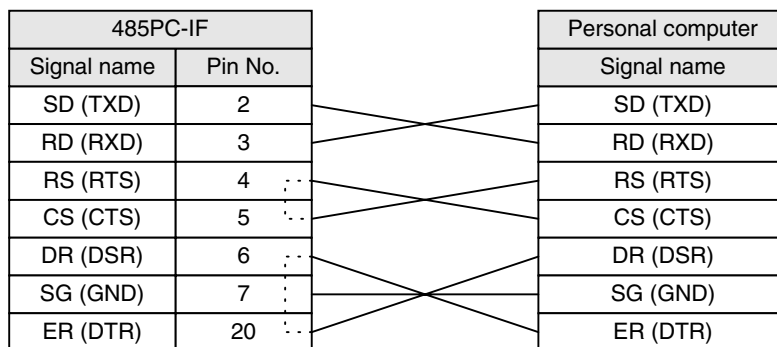

4.5 Connection Diagram for RS-485 and RS-422

4.5.1 One-pair wiring

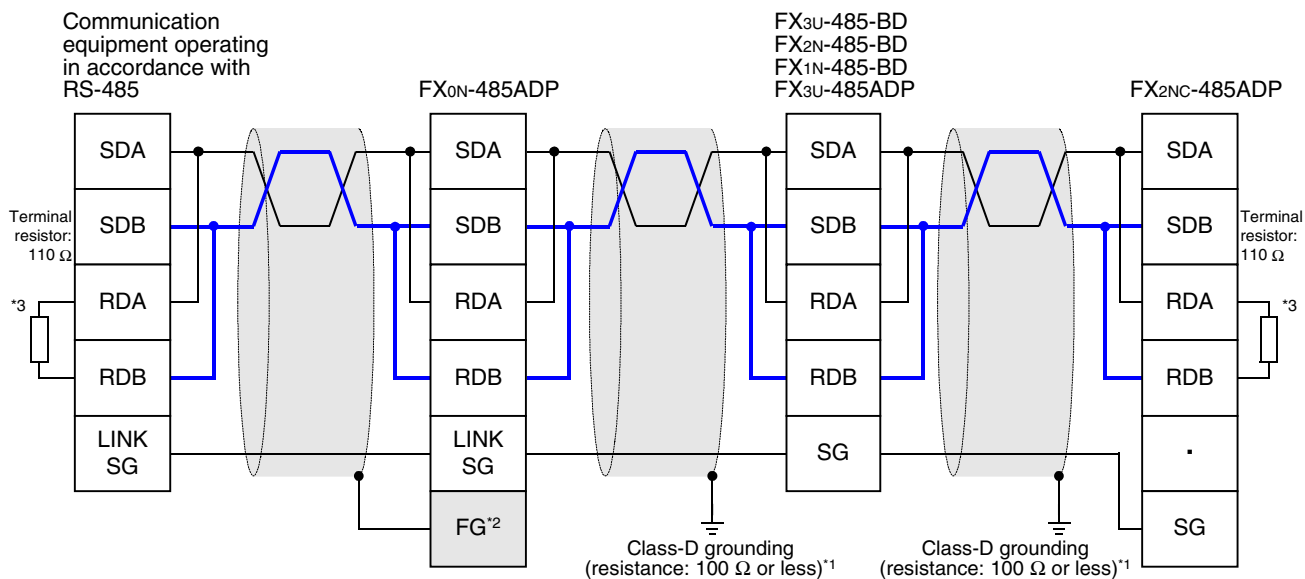

- *1 Make sure to perform Class-D grounding to the shield of a twisted pair cable connected to the FX2N-485-BD, FX1N-485-BD, FX3U-485-BD, FX2NC-485-ADP or FX3U-485ADP.
- *2 Make sure to connect the **FG** terminal to the **⏏** (grounding) terminal in the PLC requiring Class-D grounding. If the grounding terminal is not provided in the PLC, directly perform Class-D grounding.
- *3 Make sure to provide a terminal resistor at each end of a line.
 - The FX3U-485-BD and FX3U-485ADP have a built-in terminal resistor. Set the terminal resistor selector switch accordingly.
 - The FX0N-485ADP, FX2NC-485ADP, FX2N-485-BD and FX1N-485-BD are supplied together with terminal resistors.

4.5.2 Two-pair wiring

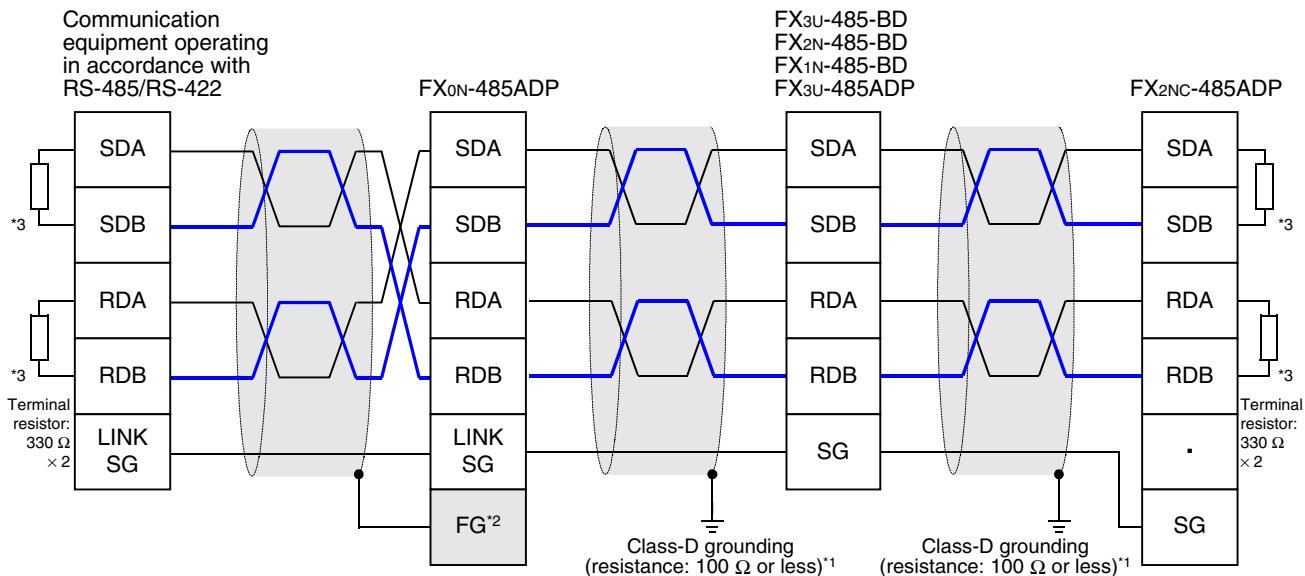

- *1 Make sure to perform Class-D grounding to the shield of a twisted pair cable connected to the FX2N-485-BD, FX1N-485-BD, FX3U-485-BD, FX2NC-485-ADP or FX3U-485ADP.
- *2 Make sure to connect the **FG** terminal to the **⏏** (grounding) terminal in the PLC requiring Class-D grounding. If the grounding terminal is not provided in the PLC, directly perform Class-D grounding.
- *3 Make sure to provide a terminal resistor at each end of a line.
 - The FX3U-485-BD and FX3U-485ADP have a built-in terminal resistor. Set the terminal resistor selector switch accordingly.
 - The FX0N-485ADP, FX2NC-485ADP, FX2N-485-BD and FX1N-485-BD are supplied together with terminal resistors.

4.6 Grounding

Grounding should be performed as stated below.

- The grounding resistance should be 100Ω or less.
- Independent grounding should be performed for best results.
 When independent grounding can not be performed, perform "shared grounding" as shown in the following figure.

→ For details, refer to the Hardware Edition of each series.

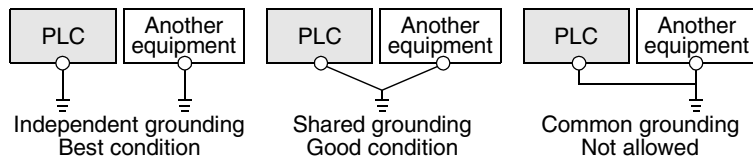

- The grounding wire size should be AWG 14 (2 mm²) or larger.
- The grounding point should be close to the PLC, and all grounding wires should be as short as possible.

A

Common Items

B

N:N Network

C

Parallel Link

D

Computer Link

E

Inverter
 Communication

F

Non-Protocol
 Communication
 (RS/RS2 Instruction)

G

Non-Protocol
 Communication
 (FX2N-232IF)

H

Programming
 Communication

I

Remote
 Maintenance

5. Communication Setting in FX Programmable Controller

This chapter explains the communication setting method types and setting methods in computer link.

5.1 Communication Setting Method Mechanism

This section explains the communication setting method types and setting contents reflection methods in FX PLCs.

1. Setting method types

- 1) Specifying the setting using parameters in the sequence programming software
Register the setting as parameters by executing communication setting on the personal computer screen using sequence programming software, and transfer them to a PLC.
(This method using parameters is not available in FX2(FX), FX2C, and FX0N PLCs.)
- 2) Specifying the setting by writing data to special data registers
Create a sequence program specifying the communication format, station number settings and timeout determination time, and then transfer the sequence program to a PLC.

Caution

A PLC operates in the same way without regard to a selected method shown above. If both methods are selected, priority is given to the method using parameters.

2. Communication setting method applicability in each FX Series

FX Series	Specification using parameters	Specification by writing setting data to special data registers
FX1S, FX1N, FX2N, FX3U, FX1NC, FX2NC, FX3UC	✓ (Recommended)	✓
FX0N, FX2(FX), FX2C	—	✓

→ For the detailed contents of special data registers, refer to Section 9.2.
→ For the method to write the setting data to special data registers, refer to Section 9.3.

3. Setting data flow

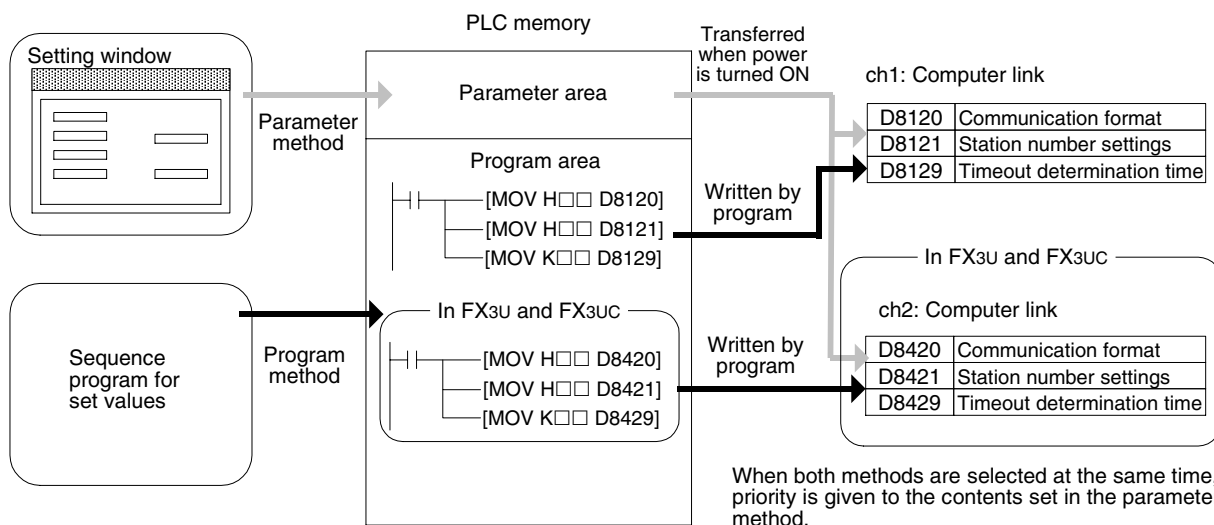

4. Timing at which the setting becomes valid

- 1) When specifying the setting using parameters
When the PLC power is turned ON, the contents of parameters set on the parameter setting window using sequence programming software are automatically transferred to the PLC.
As soon as the parameters are transferred to the PLC, the setting becomes valid.
After the program (parameters) are transferred to the PLC, it is necessary to reboot the PLC's power.
- 2) When specifying the setting by writing data to special data registers
Set the PLC mode from STOP to RUN, write the required data, reboot the PLC's power.
As soon as the PLC power is turned ON, the setting becomes valid.

5.2 Communication Setting in Parameter Method (GX Developer)

Communication settings may be changed by the parameter method with GX Developer and FXGP/WIN for Windows. This section describes how to change parameters with GX Developer.

5.2.1 Operating procedure

With GX Developer open, follow the steps in this section for activating the serial communication setting method.

1 Opening the parameter setting window

Double-click [Parameter]-[PLC parameter] from the project tree.

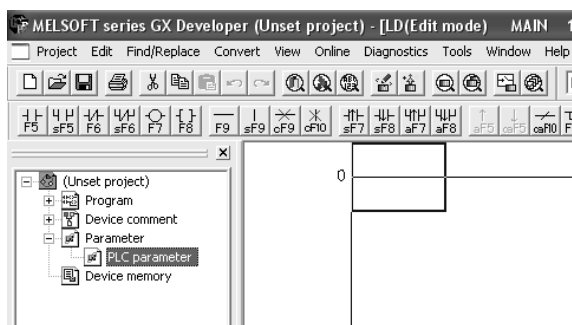

If the project tree is not displayed, select [View] - [Project data list] from the tool menu (to display a check mark on the left side).

2 Setting the serial communication (parameters)

Click the [PLC system(2)] tab on the dialog box.

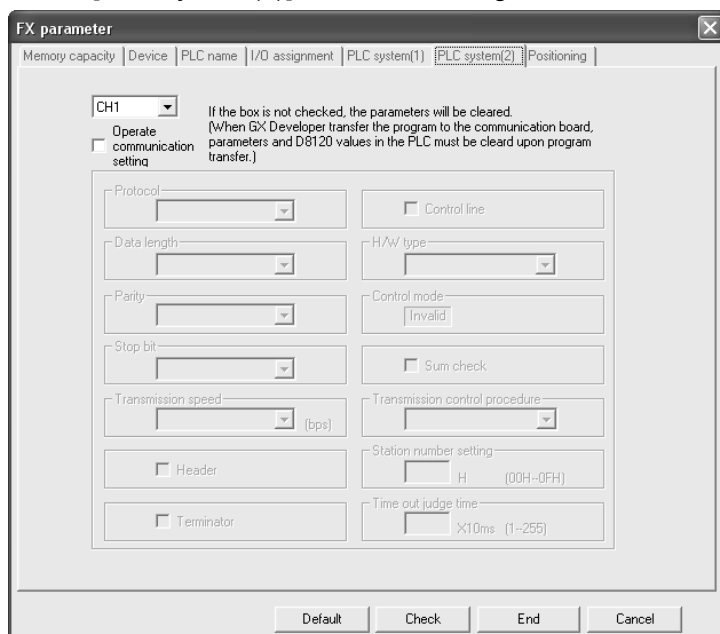

A

Common Items

B

N:N Network

C

Parallel Link

D

Computer Link

E

Inverter Communication

F

Non-Protocol Communication (RS/RS2 Instruction)

G

Non-Protocol Communication (FX2N-232IF)

H

Programming Communication

I

Remote Maintenance

3 Setting the serial communication (parameters)

Select a channel to be used, put a check mark next to the check box "Operate communication setting", and then perform the setting.

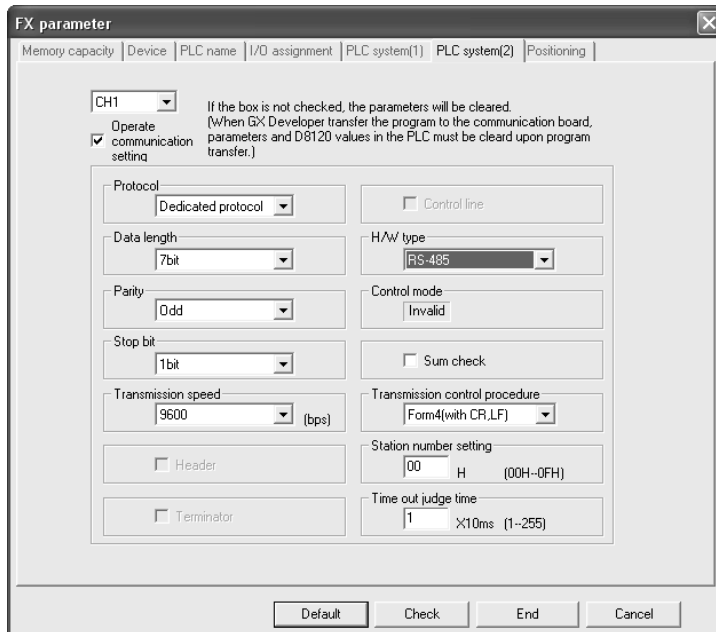

Align the contents set here with the setting in the personal computer.

4 Writing parameters to the PLC

Select [Online] - [Write to PLC] from the tool menu.
Put a check mark (✓) in "Parameter", and click [Execute].

5.3 Communication Settings in Parameter Method (FXGP/WIN)

Communication settings may be changed by the parameter method with GX Developer and FXGP/WIN for Windows. This section describes how to change parameters with FXGP/WIN. Ch2 cannot be set using FXGP/WIN.

5.3.1 Operating procedure

This subsection explains the serial communication setting method. Suppose that FXGP/WIN is already started up.

1 Displaying the serial communication (parameter) setting

Select [Option] - [Serial setting (parameter)] from the tool menu. The following dialog box appears according to absence/presence of parameter setting.

1. When there are no parameter settings

There is not communication setting. Click the [Yes] button.

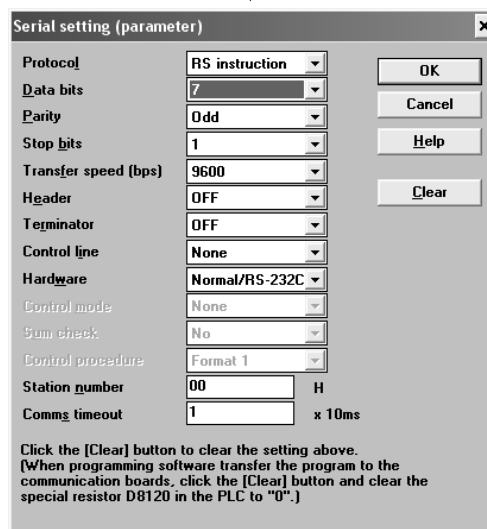
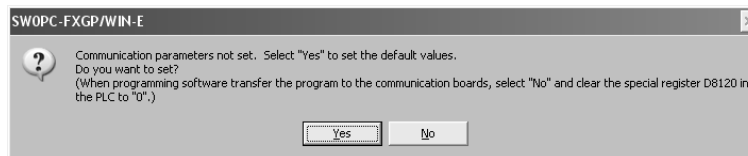

2. When there are already parameter settings

The existing communication setting contents are displayed.

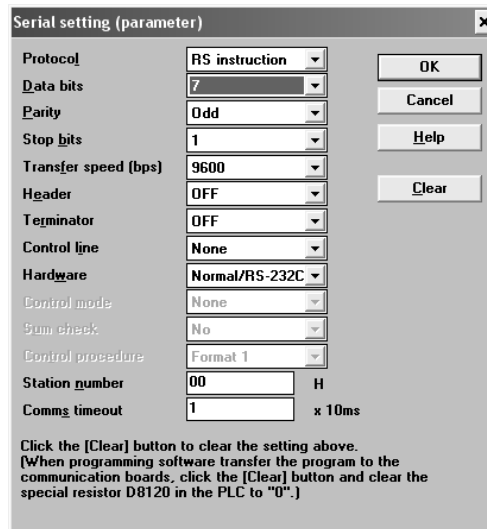

2 Executing serial communication (parameter) setting

Execute the communication setting as shown below.

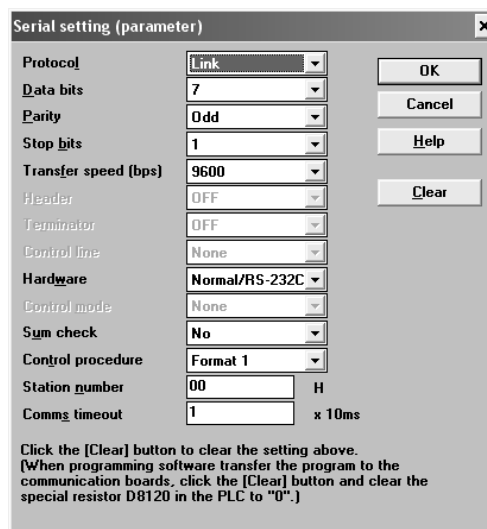

Align the contents set here with the setting in the personal computer.

3 Writing a sequence program (parameters) to the PLC

Select [PLC] - [Transfers] - [Write] from the tool menu, and click [OK].

6. Control Procedures and Setting Methods

6.1 Data Flow by Link

The figures below show images of data flow achieved when data is read from or written to a PLC CPU and the status is controlled.

In the case of communication in accordance with RS-232C, ignore "485PC-IF" and regard "485ADP" as "232ADP".

1. When the computer reads data from the PLC

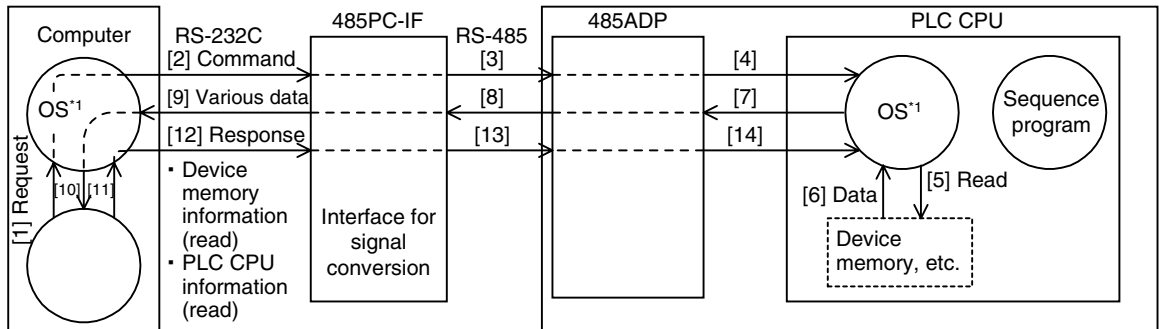

2. When the computer writes data to the PLC

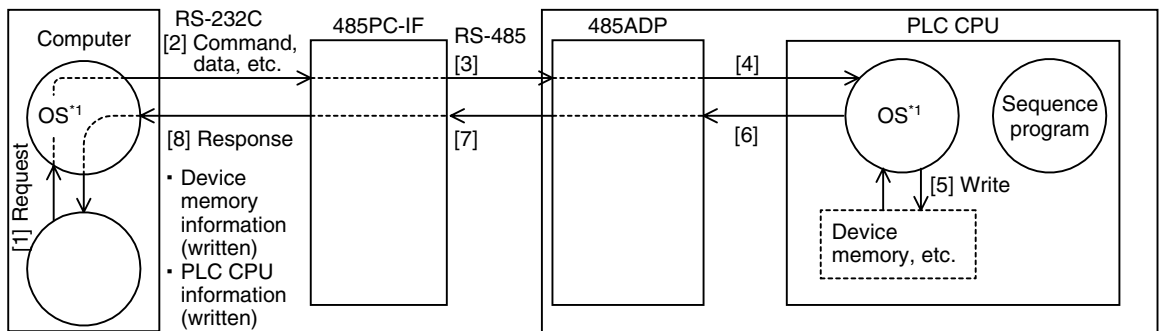

3. When the PLC sends data to the computer (on-demand function)

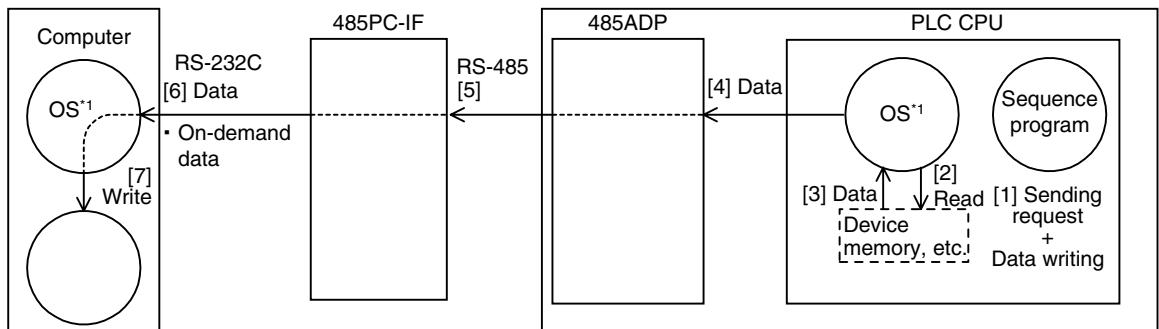

*1. The OS (standing for "Operating System") indicates the software to efficiently operate (or use) the resources including the CPUs, memories, terminals, files, and networks using user programs, etc.

A Common Items
B N:N Network
C Parallel Link
D Computer Link
E Inverter Communication
F Non-Protocol Communication (RS/RS2 Instruction)
G Non-Protocol Communication (FX2N-232IF)
H Programming Communication
I Remote Maintenance

6.2 Important Points in Computer Link

This section explains important points to be understood before creating programs for computer link.

6.2.1 Operations of PLC caused by data transfer

The PLC operations and scan time in computer link are as described below.

1. While the PLC is in RUN mode

For requests from the computer, the PLC executes access for one request in each END processing. Sending and receiving are executed as interrupts.

Accordingly, when sending and receiving are executed, the scan time is longer by about 10%. The scan time can be checked in D8010 to D8012 in the PLC.

2. Condition in which the transfer sequence in the PLC is initialized

The transfer sequence in the PLC is initialized in the following conditions:

- When the power is turned ON
- When regular sending/receiving is completed
- When the control code "EOT" or "CL" is received in each format
- When the control code "NAK" is sent
- When the timeout determination time is detected

→ For details on the timeout determination time, refer to Subsection 6.4.4.

3. Occurrence of framing error in the computer

When a commercial interface in accordance with RS-485 is used in the computer, a framing error may occur depending on the interface in the computer while nothing is sent from the PLC to the computer.

To cope with this nonconformity, let the computer ignore any data until the PLC sends STX, ACK or NAK.

4. Response of "NAK" from the PLC

When an error is detected, the PLC sends NAK to the computer.

5. Command sending from the computer

When sending commands from the computer to the PLC, wait for two scan times^{*1} or more after the PLC finishes receiving data in response to the previous command, and then send the next command.

*1. 100 μs or more in the FX2N, FX3U, FX2NC, and FX3UC Series

6.3 How to Understand Control Procedure

This section explains how to understand the transfer data shown in the later description of each function.

1. When the computer reads data from the PLC (computer ← PLC)

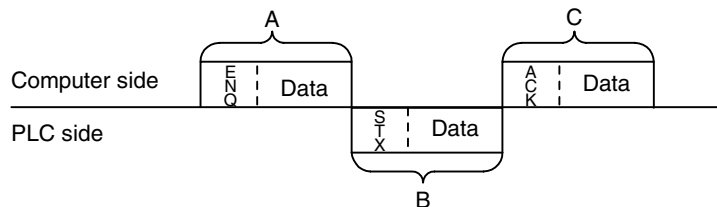

- [1] The parts A and C indicate transfer from the computer to the PLC.
- [2] The part B indicates transfer from the PLC to the computer.
- [3] Create a program in the computer so that each data is transferred in turn from the left to the right, and that the data is transferred in the order "A → B → C" as a whole.
(Example: In the part A, data is transferred in turn from the right starting from "ENQ".)

2. When the computer writes data to the PLC (computer → PLC)

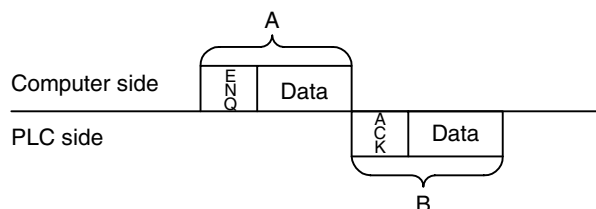

- [1] The part A indicates transfer from the computer to the PLC.
- [2] The part B indicates transfer from the PLC to the computer.
- [3] Create a program in the computer so that each data is transferred in turn from the left to the right, and that the data is transferred in the order "A → B" as a whole.
(Example: In the part A, data is transferred in turn from the right starting from "ENQ".)

6.4 Basic Formats of Dedicated Protocol

There are two types of control procedures in dedicated protocols.

CR and LF are not added to each block in format 1. CR and LF are added to each block in format 4.

(The format names are the same as those used in the computer link units for A Series PLCs.)

This section explains the contents of control procedures and the contents of each item specified in the control procedures in each format.

The basic format of control procedures (protocols) is as shown below:

→ For details, refer to Subsections 6.4.1 and 6.4.2.

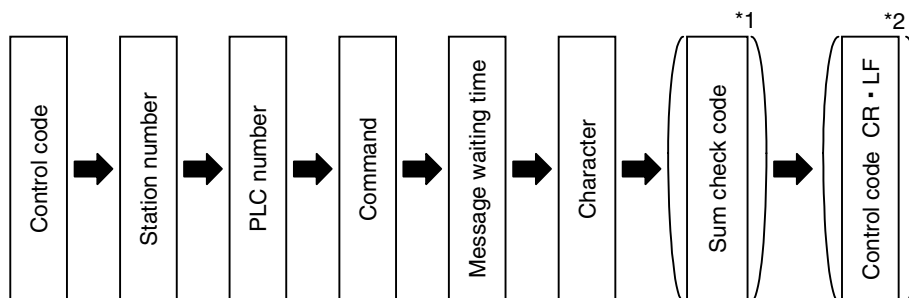

- *1. Whether or not the sum check code is added can be specified using a parameter.
- *2. Whether or not the control code is added can be specified by selecting the protocol type.

6.4.1 Control procedure format 1

The table below shows the control procedure for format 1.

Description	Control procedure (protocol)
When computer reads data from PLC	
When computer writes data to PLC	
Remarks	<ol style="list-style-type: none"> 1) The sum check code is added only when "sum check code provided" is selected. The sum check code is not added when "sum check code not provided" is selected. 2) When "sum check code provided" is selected, the sum check is executed only to the characters in the area marked with "*" in the above figure. 3) The contents of "Character area A", "Character area B" and "Character area C" vary depending on the contents of transfer, but do not vary depending on the control procedure format. → For the details on character contents, refer to "7. Commands."

6.4.2 Control procedure format 4

The table below shows the control procedure for format 4.

Description	Control procedure (protocol)
<p>When computer reads data from PLC</p>	<p>The diagram illustrates the data transfer from the PLC side to the computer side. On the computer side, the data structure is: QZM, Station No., PLC No., Command, Message wait time, Character area A, Sum check code, CL, RF. An asterisk (*) is placed above the Command, Message wait time, and Character area A fields. On the PLC side, the data structure is: STX, Station No., PLC No., Character area B, ETX, Sum check code, CL, RF. An asterisk (*) is placed above the Station No., PLC No., and Character area B fields. Alternative structures are shown: for the computer side, AK, Station No., PLC No., Error code, CL, RF; and for the PLC side, AK, Station No., PLC No., Error code, CL, RF. Arrows indicate the direction of data flow.</p>
<p>When computer writes data to PLC</p>	<p>The diagram illustrates the data transfer from the computer side to the PLC side. On the computer side, the data structure is: QZM, Station No., PLC No., Command, Message wait time, Character area C, Sum check code, CL, RF. An asterisk (*) is placed above the Command, Message wait time, and Character area C fields. On the PLC side, the data structure is: ACK, Station No., PLC No., CL, RF. An asterisk (*) is placed above the Station No., PLC No., and CL fields. Alternative structures are shown: for the computer side, AK, Station No., PLC No., Error code, CL, RF; and for the PLC side, AK, Station No., PLC No., Error code, CL, RF. Arrows indicate the direction of data flow.</p>
<p>Remarks</p>	<ol style="list-style-type: none"> 1) The sum check code is added only when "sum check code provided" is selected. The sum check code is not added when "sum check code not provided" is selected. 2) When "sum check code provided" is selected, the sum check is executed only to the characters in the area marked with "*" in the above figure. 3) The contents of "Character area A", "Character area B" and "Character area C" vary depending on the contents of transfer, but do not vary depending on the control procedure format. → For the details on character contents, refer to "7. Commands."

A	Common Items
B	N:N Network
C	Parallel Link
D	Computer Link
E	Inverter Communication
F	Non-Protocol Communication (RS/RS2 Instruction)
G	Non-Protocol Communication (FX2N-232IF)
H	Programming Communication
I	Remote Maintenance

6.4.3 Contents of set items in each control procedure (protocol)

This subsection explains the contents of each data used in each control procedure.

1. Control codes

The table below shows control codes.

Signal name	Code	Description
STX	02H	Start of Text
ETX	03H	End of Text
EOT	04H	End of Transmission
ENQ	05H	Enquiry
ACK	06H	Acknowledge

Signal name	Code	Description
LF	0AH	Line Feed
CL	0CH	Clear
CR	0DH	Carriage Return
NAK	15H	Negative Acknowledge

- When the PLC receives ENQ or ACK, it initializes the transfer sequence and begins receiving.
- When the PLC receives EOT or CL as shown below, it initializes the transfer sequence. At this time, the PLC gives no response.

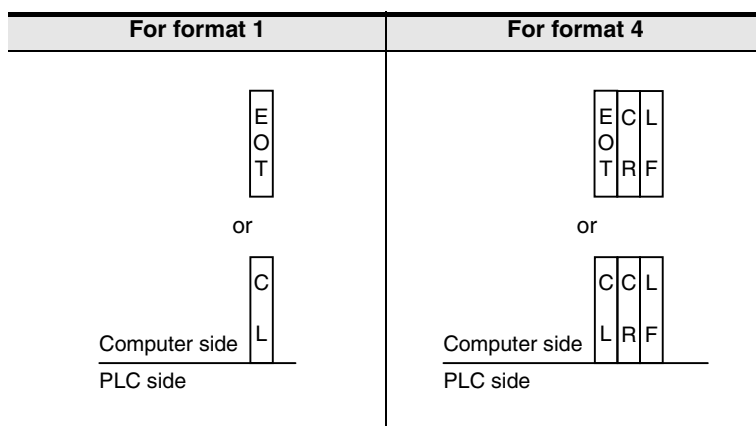

2. Station number

The station number indicates a number provided in each PLC to determine to which PLC the computer accesses.

The station number is specified in hexadecimal.

- In FX Series PLCs, set the station number using a parameter. The setting range is from 00H to 0FH.
- For the station number settings method in A Series PLCs, refer to the manual of each A Series PLC.

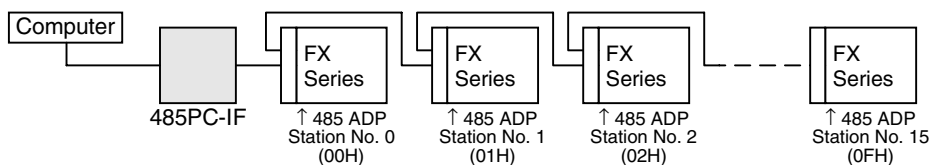

In FX2(FX), FX2C and FX0N PLCs, set a value to D8121.



→ For details on the program, refer to Section 9.3.

Cautions on setting the station number

- Do not overlap the station number. If the same number is set in two or more stations, the transfer data is destroyed and normal communication is disabled.
- It is not necessary to set consecutive station numbers as shown in the setting example above. Any station numbers in the setting range (00H to 0FH) are applicable. (Examples: Station numbers may be set at random. Some station numbers may be skipped.)

3. PLC number

The PLC number is used to identify a PLC to be accessed when computer link is combined with the MELSECNET (II) or MELSECNET/B in A Series PLCs. The PLC number of each FX Series PLC is fixed to "FFH", and converted into two-digit ASCII code.

When the on-demand function is used, however, the PLC number is automatically changed to "FEH" by the PLC.

For the PLC number of an A Series PLC used together with the MELSECNET (II) or MELSECNET/B, refer to the manual of the A Series PLC.

4. Command

A command specifies the contents of access executed by the computer to a PLC.

A command is converted into a two-digit ASCII code.

→ For the explanation of commands, refer to Chapter 7.

5. Message waiting time

The message waiting time should be specified because some computers require more time before receiving additional data. Set the waiting time according to the specifications of each computer.

Set the waiting time within the range from 0 to 150 ms in units of 10 ms. 10 ms is handled as "1H", and a value in the range from "0H (0)" to "FH (15)" is converted into a one-digit ASCII code.

When executing communication using the 485PC-IF in a 1-to-N system adopting the one-pair wiring, make sure to set the message waiting time to 70 ms (7) or more. When the scan time of a PLC in the system exceeds 70 ms, set the message waiting time to the maximum scan time or higher.

Example: When the message waiting time is set to 100 ms

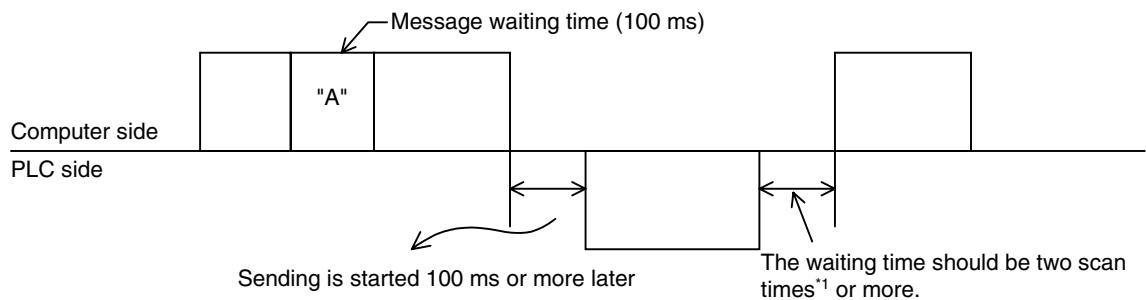

*1. 100 μs in the FX2N, FX3U, FX2NC, and FX3UC Series

6. Sum check code

The sum check code indicates a two-digit ASCII code converted from the least significant byte (8-bit) of the sum check target data added as hexadecimal data.

By setting a parameter of an FX PLC, set whether or not the sum check code is added in the message.

- When "sum check code provided" is selected, the sum check code is added in the message during sending. During receiving, the sum check code is compared with the value calculated from the received data to check the received data.
- When "sum check code not provided" is selected, the sum check code is not added, so the received data is not checked either. A calculation example of the sum check code is shown below.

Example: When the station number "0", PLC number "FF", command "BR (device memory batch read)," message waiting time "30 ms" and data "ABCD" are transferred in format 1, the sum check code value is as shown below:

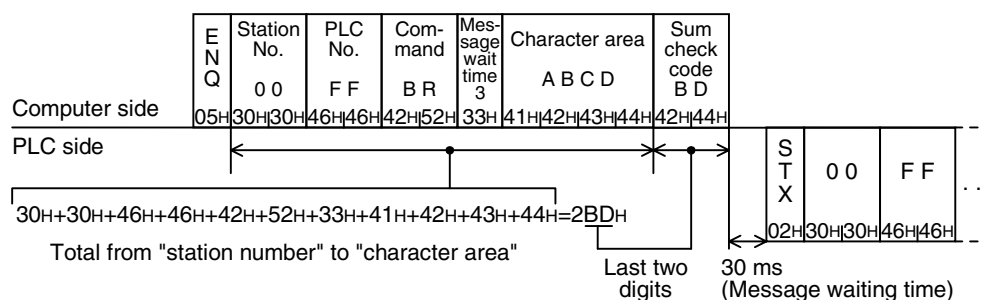

6.4.4 Timeout determination time

When the receiving of data from the computer is interrupted and is not restarted within the preset time (timeout determination time), the PLC regards the situation as a timeout error and initializes the transfer sequence.

1. Timeout determination time setting range

The timeout determination time can be set in a parameter or sequence program.
 In the FX2(FX), FX2C, and FX0N Series, however, the parameter setting method is not applicable.
 When setting the timeout determination time in a sequence program, write a value for ch.1 to D8129, and a value for ch.2 (in the FX3U and FX3UC Series) to D8429 (unit: 10 ms).
 The setting range is different between the parameter method and the sequence program method.

1) Details of setting range

FX Series		Setting range in parameter	Setting range in sequence program (D8129 and D8429)
FX2(FX), FX2C		Not applicable	1 to 3276 (10 to 32760 ms)
FX0N		Not applicable	1 to 255 (10 to 2550 ms)
FX1S, FX1N, FX1NC		1 to 255 (10 to 2550 ms)	1 to 255 (10 to 2550 ms)
FX2N, FX2NC		1 to 255 (10 to 2550 ms)	1 to 3276 (10 to 32760 ms)
FX3U, FX3UC	ch1	1 to 255 (10 to 2550 ms)	1 to 3276 (10 to 32760 ms)
	ch2	1 to 3276 (10 to 32760 ms)	1 to 3276 (10 to 32760 ms)

When the set value is "0", it is handled as "100 ms."

2) Example of setting program

When setting the timeout determination time to 60 ms



→ For details on the program, refer to Section 9.3.

2. Caution on programming

The timeout determination time is not updated until the next character data is received. Set a time to receive a character according to the transmission speed (baud rate).

For one character (12-bit), the minimum set value of the timeout determination time is as shown below:

Baud rate (bps)	Time to receive one character (ms)	Timeout determination time (minimum set value)
300	40	50 ms (5)
600	20	30 ms (3)
1200	10	20 ms (2)
2400	5	10 ms (1)
4800	2.5	10 ms (1)
9600	1.25	10 ms (1)
19200	0.625	10 ms (1)

6.5 Transfer Sequence Time Chart and Communication Time

This section explains the communication time chart between the computer and the PLC.

As shown in the figures below, communication between the computer and the PLC is always executed after "END". The scan time is longer by as much as the communication time.

6.5.1 When computer reads data from PLC

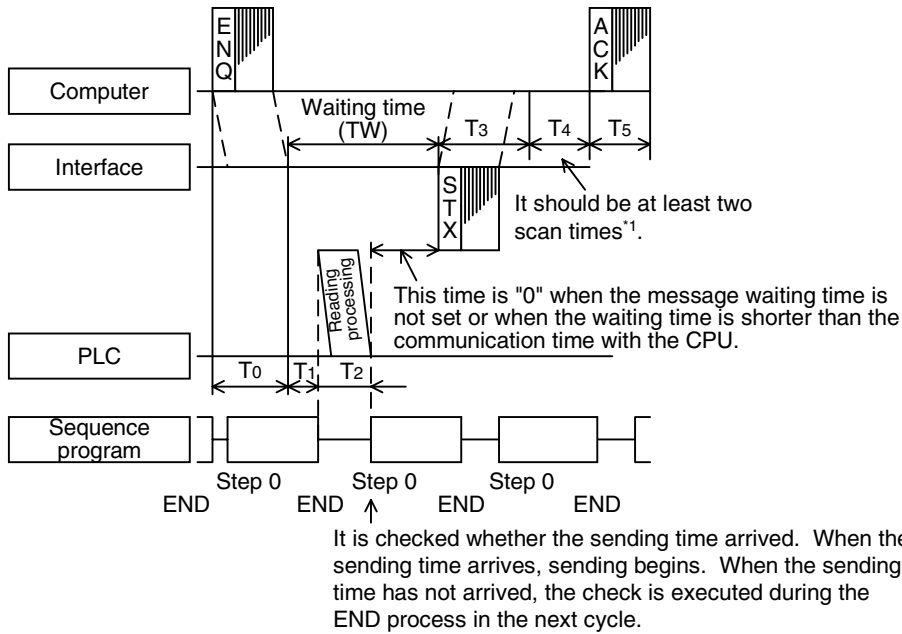

*1. 100 μs in the FX2N, FX3U, FX2NC, and FX3UC Series

6.5.2 When computer writes data to PLC

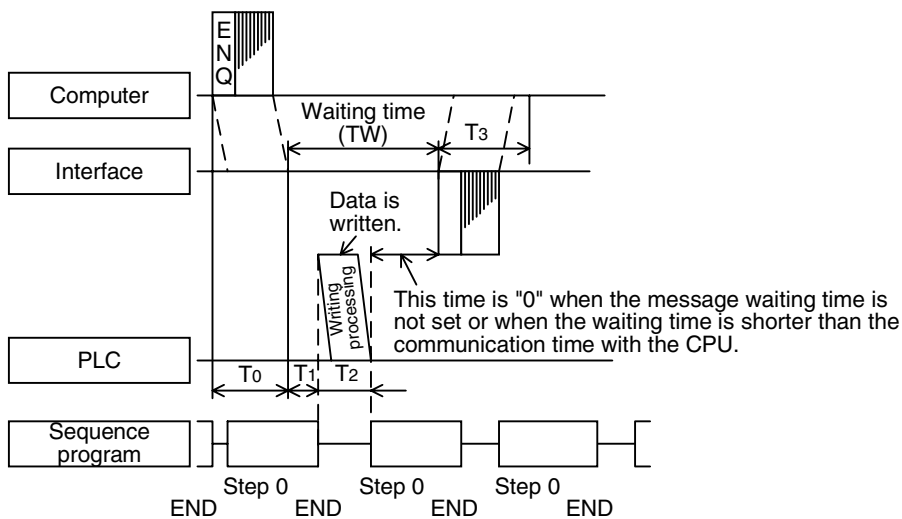

A	Common Items
B	N:N Network
C	Parallel Link
D	Computer Link
E	Inverter Communication
F	Non-Protocol Communication (RS/RS2 Instruction)
G	Non-Protocol Communication (FX2N-232IF)
H	Programming Communication
I	Remote Maintenance

6.5.3 Transfer time in transfer sequence

This subsection explains how to calculate the approximate time after the computer starts data transfer and the PLC gives a response until all communication is completed.
 For the contents of T0 to T5, refer to the previous page.

1. When the computer reads data from the PLC

Communication time = T0 + (T1 + Longer time between T2 and TW) + T3 + T4 + T5

$$T0, T3, T5 = \frac{1}{\text{Baud rate}} \times \text{Number of bits in one character} \times \text{Number of characters}$$

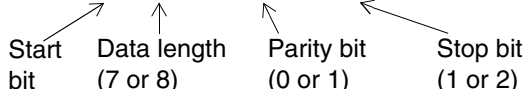
$$(1 + 7(8) + 0(1) + 1(2))$$

- T1: Maximum one scan time (Because data is read from the PLC during the END processing while the PLC is in RUN mode, reading requires up to one scan time depending on the sending timing. Reading requires about 1 ms while the PLC is in STOP mode.)
- T2: END processing time in the PLC executing data transfer
- T4: Scan time or longer (In the case of wiring in the 1-to-N configuration, T4 should be longer than the timeout determination time (D8129) added by one scan time.)
- TW: Message waiting time

2. When the computer writes data to the PLC

Communication time = T0 + (T1 + Longer time between T2 and TW) + T3

$$T0, T3 = \frac{1}{\text{Baud rate}} \times \text{Number of bits in one character} \times \text{Number of characters}$$

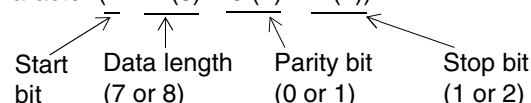
$$(1 + 7(8) + 0(1) + 1(2))$$

- T1: Maximum one scan time (Because data is written to the PLC during the END processing while the PLC is in RUN mode, writing requires up to one scan time depending on the sending timing. Writing requires about 1 ms while the PLC is in STOP mode.)
- T2: END processing time in the PLC executing data transfer
- TW: Message waiting time

6.6 Transfer Data in Character Area

This section explains the transfer data in the character area sent and received between the computer and a PLC using each command.

The transfer data explained below is handled as the character area B in reading and the character area C in writing.

→ For character areas, refer to Subsections 6.4.1 and 6.4.2.

6.6.1 When bit device memory is read or written

The bit device memory is handled in units of bit (1 point) or in units of word (16 points).
The transfer data in each case is explained below.

1) In units of 1 bit (1 point)

When the bit device memory is handled in units of 1 bit (1 point), a specified number of devices starting from the specified head device are expressed in turn from the left end in "1 (31H)" for the ON status or "0 (30H)" for the OFF status.

Example: When indicating the ON/OFF status of five devices starting from M10

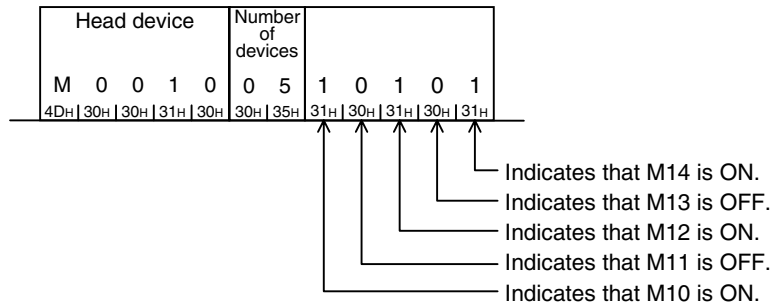

2) In units of words (16 points)

When the bit device memory is handled in units of words (16 points), one word is expressed in units of 4-bits in turn from the most significant bit in hexadecimal.

Example: When indicating the ON/OFF status of 32 devices starting from M16

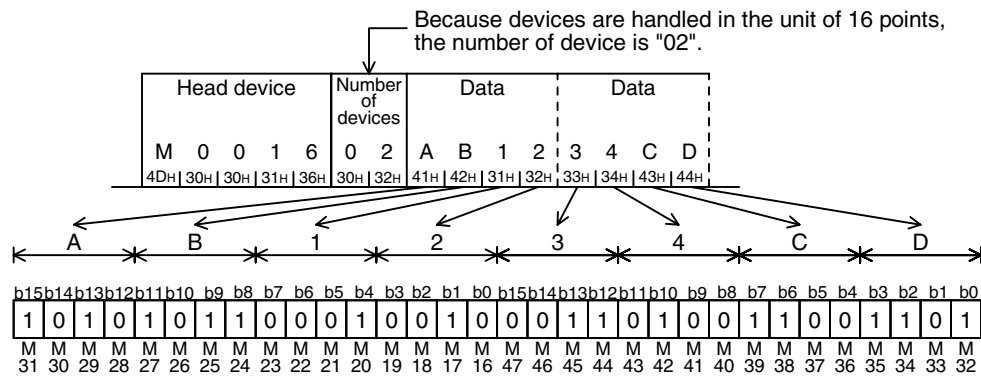

6.6.2 When word device memory is read or written

In the case of word device memory, one word is expressed in units of 4-bits in turn from the most significant bit in hexadecimal.

Example 1: When indicating the contents stored in the data registers D350 and D351

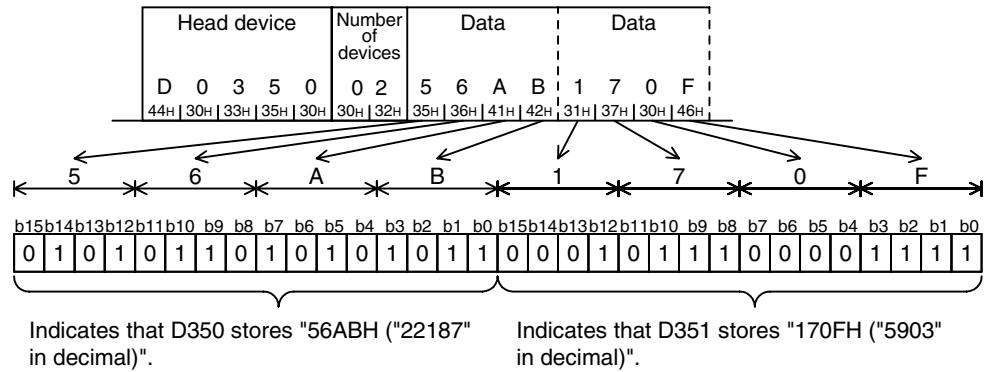

Example 2: When indicating the contents stored in the 32-bit counter C200*1

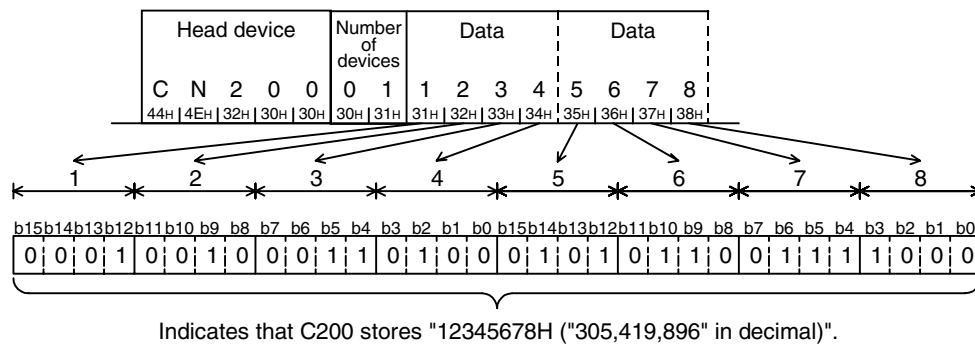

*1. For indicating the current value of C200, use "CN200".

7. Commands

This chapter explains specification methods and specification examples of commands in dedicated protocols used in computer link communication type.

For control procedures in dedicated protocols, refer to "6. Control Procedures and Setting Methods".

The table below shows a reference section for each command.

Command	Contents of processing	Applicable PLC		Reference section
		FX3U, FX3UC	FX2(FX), FX2C, FX1S, FX0N, FX2N, FX1N, FX2NC, FX1NC	
BR	Reads bit devices in units of 1 point.	✓	✓	7.1
WR	Reads bit devices in units of 16 point, or word devices in units of 1 point.	✓	✓	7.2
QR	Reads bit devices in units of 16 point, or word devices in units of 1 point.	✓	—	7.3
BW	Writes bit devices in units of 1 point.	✓	✓	7.4
WW	Writes bit devices in units of 16 point, or word devices in units of 1 point.	✓	✓	7.5
QW	Writes bit devices in units of 16 point, or word devices in units of 1 point.	✓	—	7.6
BT	Specifies bit devices at random in units of 1 point, and sets or resets them (forcibly sets them to ON or OFF).	✓	✓	7.7
WT	Specifies bit devices at random in units of 16 points, and sets or resets them (forcibly sets them to ON or OFF). Or specifies word devices at random in units of 1 point, and writes data to them.	✓	✓	7.8
QT	Specifies bit devices at random in units of 16 points, and sets or resets them (forcibly sets them to ON or OFF). Or specifies word devices at random in units of 1 point, and writes data to them.	✓	—	7.9
RR	Sets a PLC to RUN mode in remote control.	✓	✓	7.10
RS	Sets a PLC to STOP mode in remote control.	✓	✓	
PC	Reads the PLC model name code.	✓	✓	7.11
GW	Turns ON or OFF the global function in all linked PLCs.	✓	✓	7.12
—	Offers the on-demand function (by which a PLC gives a sending request), and does not offer any command.	✓	✓	7.13
TT	Returns characters received from the computer as they are to the computer.	✓	✓	7.14

A

Common Items

B

N:N Network

C

Parallel Link

D

Computer Link

E

Inverter Communication

F

Non-Protocol Communication (RS/RS2 Instruction)

G

Non-Protocol Communication (FX2N-232IF)

H

Programming Communication

I

Remote Maintenance

7.1 BR Command [Which Reads Device Memory in Units of Bits]

This section explains the control procedure specification method and specification example when the bit device memory is read at one time.

1. Specification method

The specification method in the control procedure format 1 is shown below:

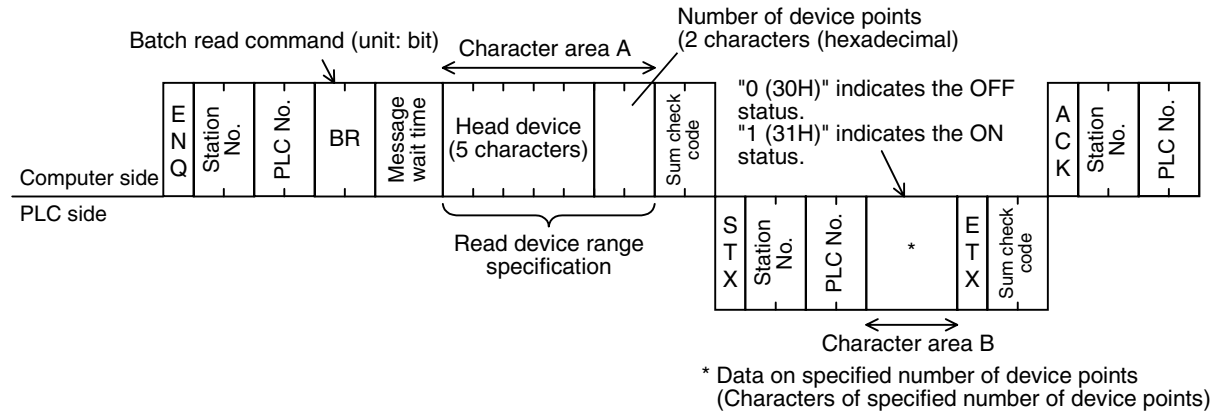

- 1) Specify the device point range while satisfying the following conditions:
 - $1 \leq \text{Number of device points} \leq 256^{*1}$ (Use "00H" to specify 256 points.)
 - $\text{Head device number} + \text{Number of device points} - 1 \leq \text{Maximum device number}$
- 2) Express the station number, PLC number, number of device points and sum check code in hexadecimal respectively.
 - *1. 54 in the FX1S and FX0N Series

2. Specification example

When reading the contents of five devices X040 to X044 in the PLC whose station number is 5 (while the message waiting time is set to 100 ms)
 (When X040 and X043 are OFF and X041, X042 and X044 are ON)

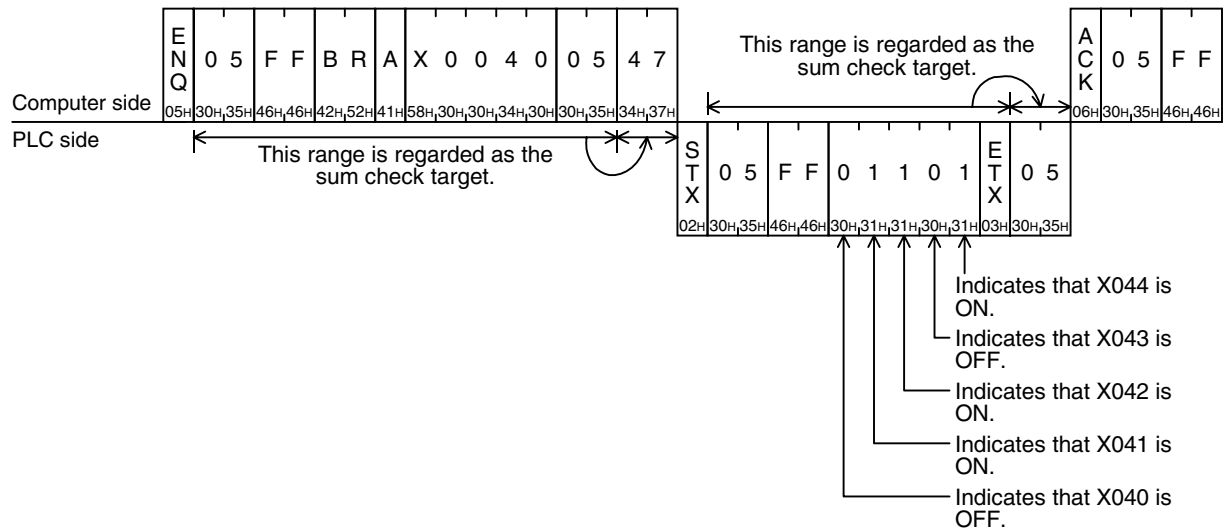

Important point

The message wait time is specified in units of 10 ms within the range from 0 to 150 ms, and expressed in hexadecimal within the range from 0 to FH. For example, "100 ms" is expressed as "A".

7.2 WR Command [Which Reads Device Memory in Units of Words]

This section explains the control procedure specification method and specification examples when the word device memory is read at one time or when the bit device memory is read (in units of 16 points) at one time.

1. Specification method

The specification method in the control procedure format 1 is shown below:

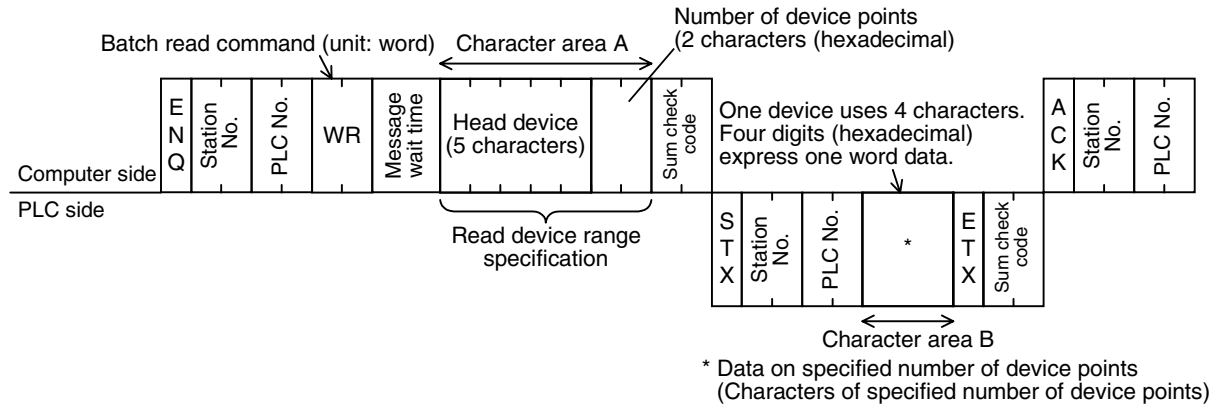

1) Specify the device point range while satisfying the following conditions:

- $1 \leq \text{Number of device points} \leq 64^*1$ (32^*1 in case of bit devices)
- Head device number + Number of device points ("Number of devices \times 16" in case of bit devices) - 1 \leq Maximum device number
- When 32-bit devices (CN200 to CN255) are read, one device point is handled as two word data. Accordingly, up to 32 device points^{*2} can be specified.

2) Express the station number, PLC number, number of device points and sum check code in hexadecimal respectively.

*1. Up to 13 device points in the FX1S and FX0N Series

*2. Up to 6 device points in the FX1S and FX0N Series

2. Specification examples

Example 1: When reading the contents of thirty-two devices from X040 to X077 in the PLC whose station number is 5 (while the message waiting time is set to 0 ms)

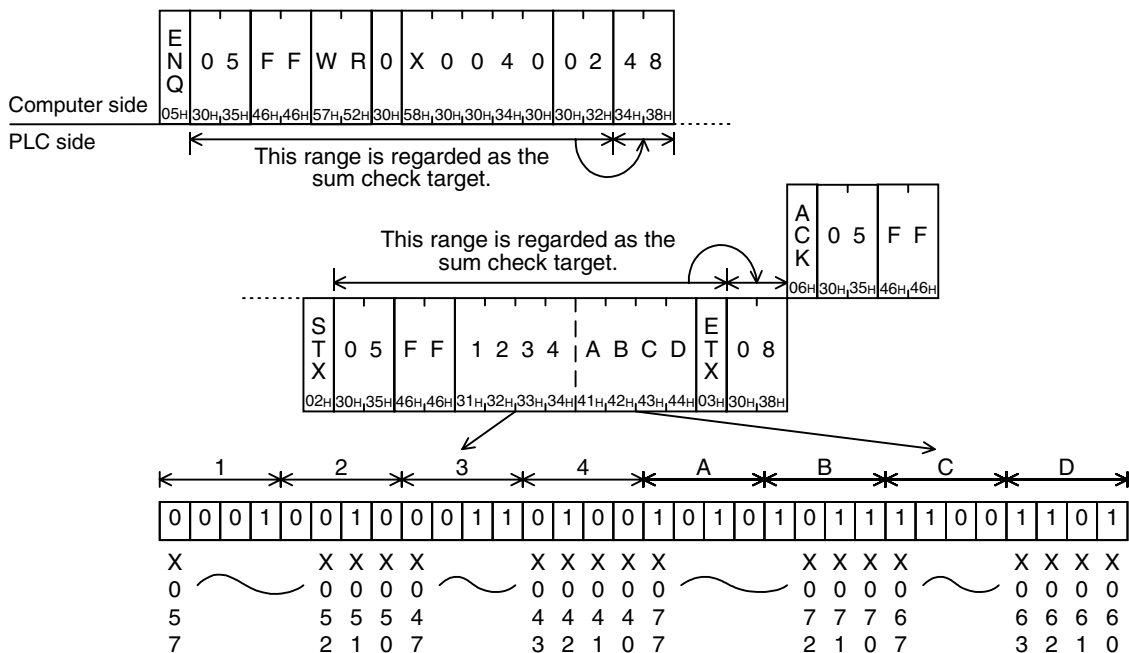

Important point

The WR command handles data in units of word. When reading thirty-two devices from X040 to X077, specify the number of device points as "02" (One point specifies 16 devices.)

Example 2: When reading the present value of two devices from T123 and T124 in the PLC whose station number is 5 (while the message waiting time is set to 0 ms)

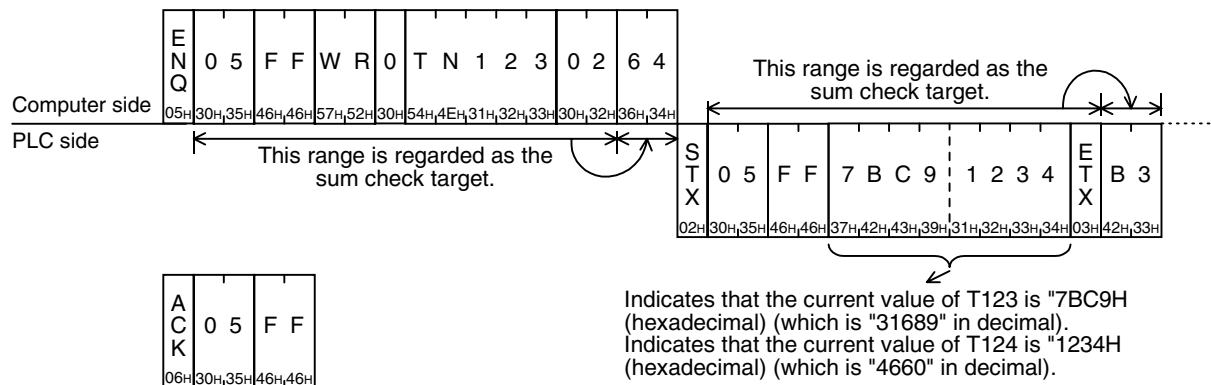

7.3 QR Command [Which Reads Device Memory in Units of Words]

This section explains the control procedure specification method and specification examples when the word device memory is read at one time or when the bit device memory is read (in units of 16 points) at one time.

1. Specification method

The specification method in the control procedure format 1 is shown below:

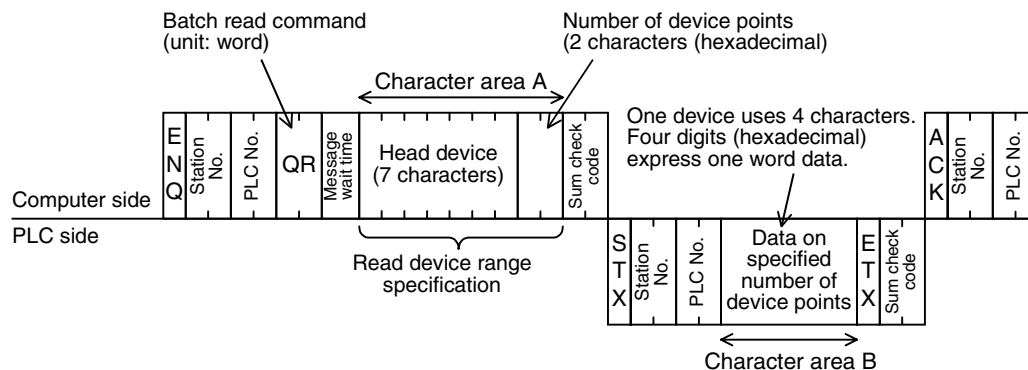

- 1) This command is available only in FX3U and FX3UC PLCs.
- 2) Specify the device point range while satisfying the following conditions:
 - $1 \leq \text{Number of device points} \leq 64$ (32 for bit devices)
 - Head device number + Number of device points ("Number of devices \times 16" for bit devices) - 1 \leq Maximum device number
 - When 32-bit devices (CN00200 to CN00255) are read, one device point is handled as two word data. Accordingly, up to 32 device points can be specified.
- 3) Express the station number, PLC number, number of device points and sum check code in hexadecimal respectively.

2. Specification examples

Example 1: When reading the contents of thirty-two devices from X040 to X077 in the PLC whose station number is 5 (while the message waiting time is set to 0 ms)

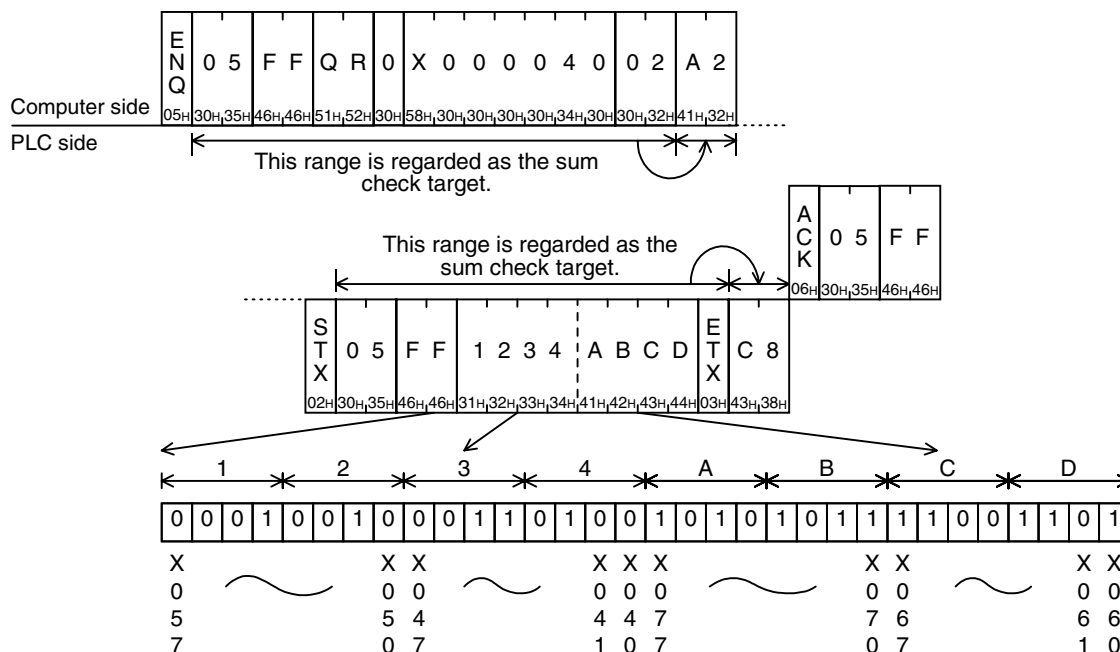

Example 2: When reading the contents of two devices from R30000 to R30001 in the PLC whose station number is 5 (while the message waiting time is set to 0 ms)

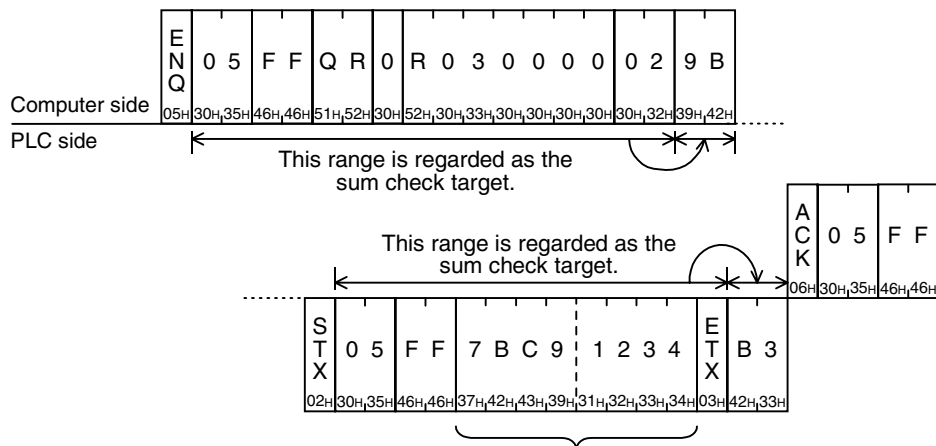

Indicates that the value of R30000 is "7BC9H" (hexadecimal)
 (which is "31689" in decimal).
 Indicates that the value of R30001 is "1234H" (hexadecimal)
 (which is "4660" in decimal).

7.4 BW Command [Which Writes Device Memory in Units of Bits]

This section explains the control procedure specification method and shows a specification example when the bit device memory is written at one time.

1. Specification method

The specification method in the control procedure format 1 is shown below:

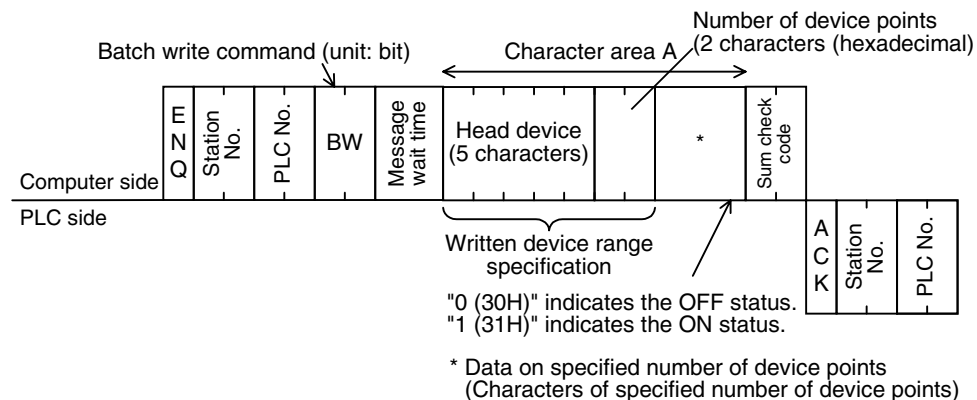

- 1) Specify the device point range while satisfying the following conditions:
 - $1 \leq \text{Number of device points} \leq 160^{*1}$
 - $\text{Head device number} + \text{Number of device points} - 1 \leq \text{Maximum device number}$
- 2) Express the station number, PLC number, number of device points and sum check code in hexadecimal respectively.
 - *1. 46 in the FX1S and FX0N Series

2. Specification example

When writing data to five devices from M903 to M907 in the PLC whose station number is 0 (while the message waiting time is set to 0 ms)

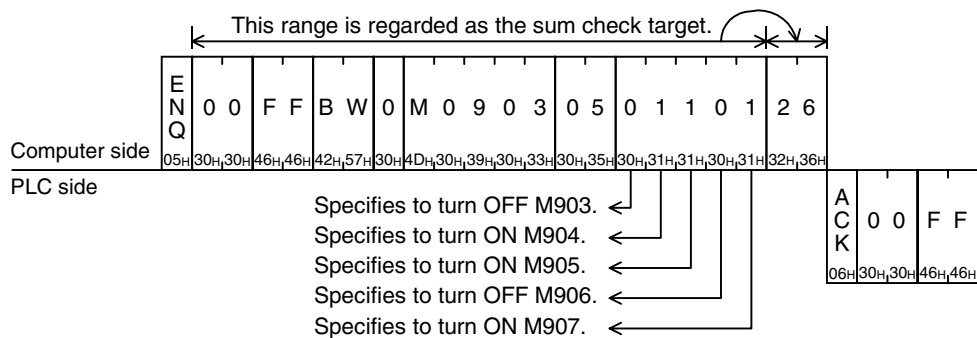

7.5 WW Command [Which Writes Device Memory in Units of Words]

This section explains the control procedure specification method and shows a specification examples when the word device memory is written at one time or when the bit device memory is written (in units of 16 points) at one time.

1. Specification method

The specification method in the control procedure format 1 is shown below:

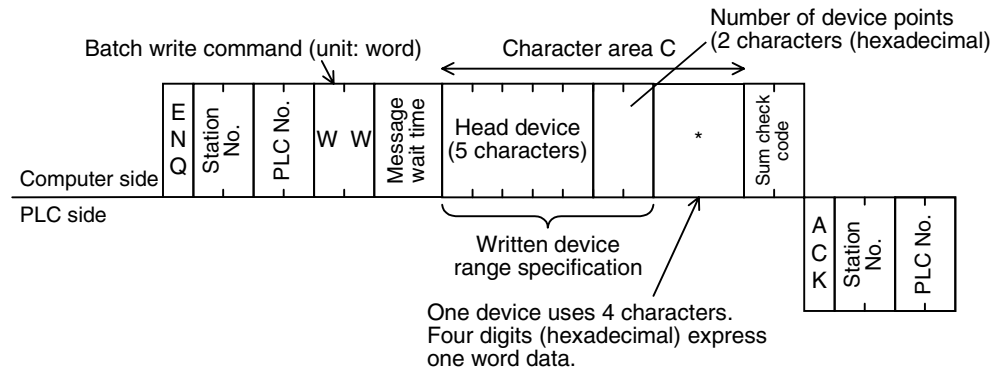

1) Specify the device point range while satisfying the following conditions:

- $1 \leq \text{Number of device points} \leq 64^{*1}$ (10 in case of bit devices)
- Head device number + Number of device points ("Number of devices x 16" in case of bit devices) - 1 ≤ Maximum device number
- When 32-bit devices (CN200 to CN255) are written, one device point is handled as two word data. Accordingly, up to 32 device points^{*2} can be specified.

2) Express the station number, PLC number, number of device points and sum check code in hexadecimal respectively.

*1. Up to 11 device points in the FX1S and FX0N Series

*2. Up to 5 device points in the FX1S and FX0N Series

2. Specification examples

Example 1: When writing data to thirty-two devices from M640 to M671 in the PLC whose station number is 0 (while the message waiting time is set to 0 ms)

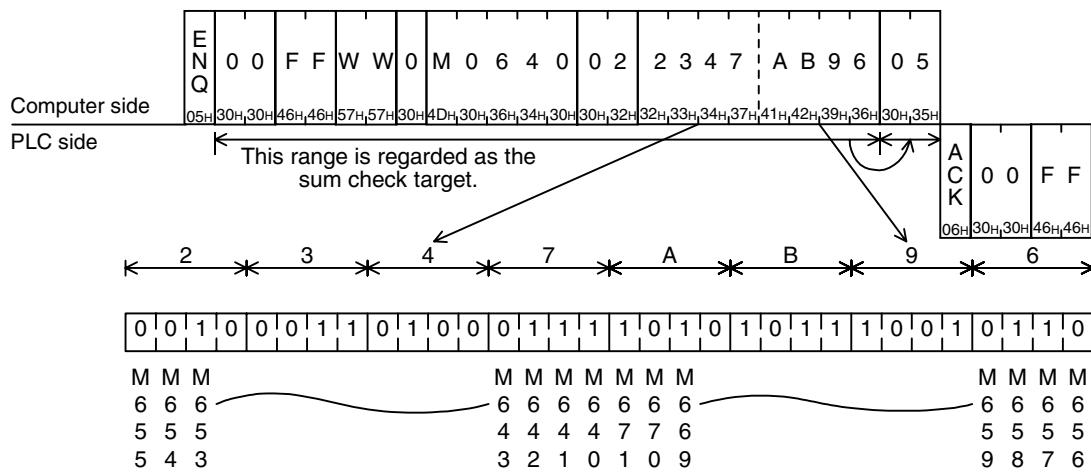

Important point

The WW command handles data in units of word. When writing data to thirty-two devices from M640 to M671, specify the number of device points as "02" (One point specifies 16 devices.)

Example 2: When writing data to two devices D0 and D1 in the PLC whose station number is 0 (while the message waiting time is set to 0 ms)

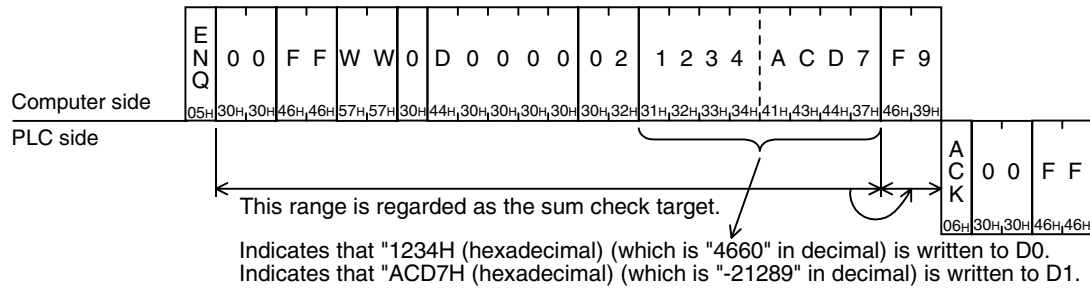

A	Common Items
B	N:N Network
C	Parallel Link
D	Computer Link
E	Inverter Communication
F	Non-Protocol Communication (RS/RS2 Instruction)
G	Non-Protocol Communication (FX2N-232IF)
H	Programming Communication
I	Remote Maintenance

7.6 QW Command [Which Writes Device Memory in Units of Words]

This section explains the control procedure specification method and shows a specification examples when the word device memory is written at one time or when the bit device memory is written (in units of 16 points) at one time.

1. Specification method

The specification method in the control procedure format 1 is shown below:

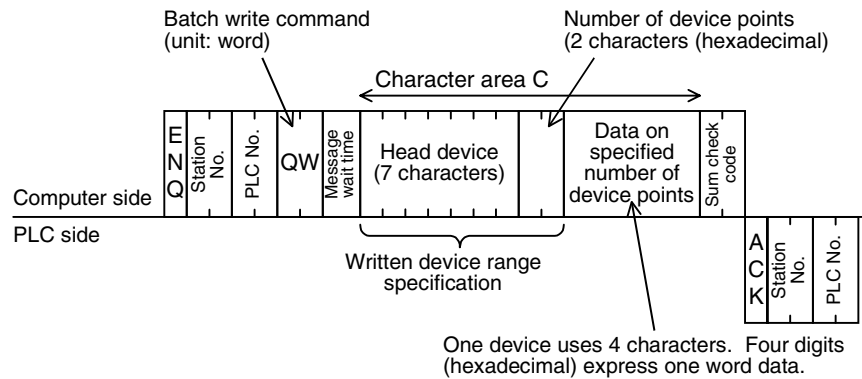

- 1) This command is available only in FX3U and FX3UC PLCs.
- 2) Specify the device point range while satisfying the following conditions:
 - $1 \leq \text{Number of device points} \leq 64$ (10 in case of bit devices)
 - Head device number + Number of device points ("Number of devices \times 16" in case of bit devices) - 1 \leq Maximum device number
 - When 32-bit devices (CN00200 to CN00255) are written, one device point is handled as two word data. Accordingly, up to 32 device points can be specified.
- 3) Express the station number, PLC number, number of device points and sum check code in hexadecimal respectively.

2. Specification examples

Example 1: When writing data to thirty-two devices from M640 to M671 in the PLC whose station number is 5 (while the message waiting time is set to 0 ms)

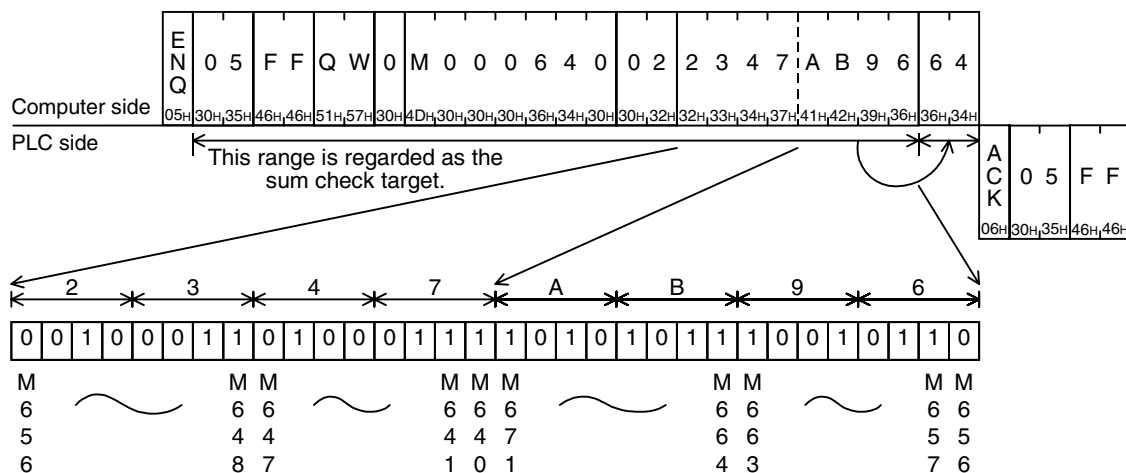

Example 2: When writing data to two devices from R30000 to R30001 in the PLC whose station number is 5 (while the message waiting time is set to 0 ms)

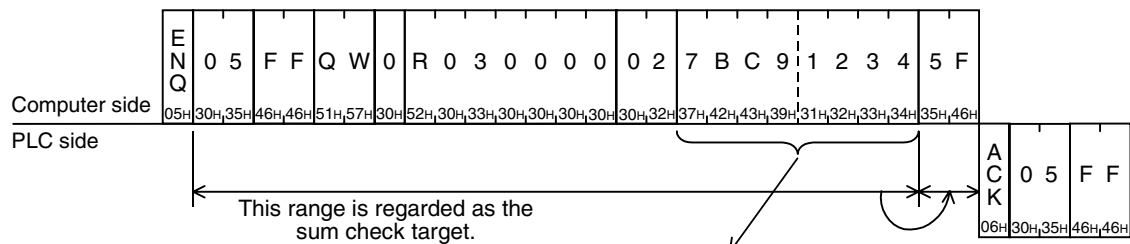

Indicates that "7BC9H (hexadecimal) (which is "31689" in decimal) is written to R30000.
 Indicates that "1234H (hexadecimal) (which is "4660" in decimal) is written to R30001.

A	Common Items
B	N:N Network
C	Parallel Link
D	Computer Link
E	Inverter Communication
F	Non-Protocol Communication (RS/RS2 Instruction)
G	Non-Protocol Communication (FX2N-232IF)
H	Programming Communication
I	Remote Maintenance

7.7 BT Command [Which Tests Device Memory in Units of Bits (by Writing at Random)]

This section explains the control procedure specification method and shows a specification example when the bit device memory is specified at random and written at one time.

1. Specification method

The specification method in the control procedure format 1 is shown below:

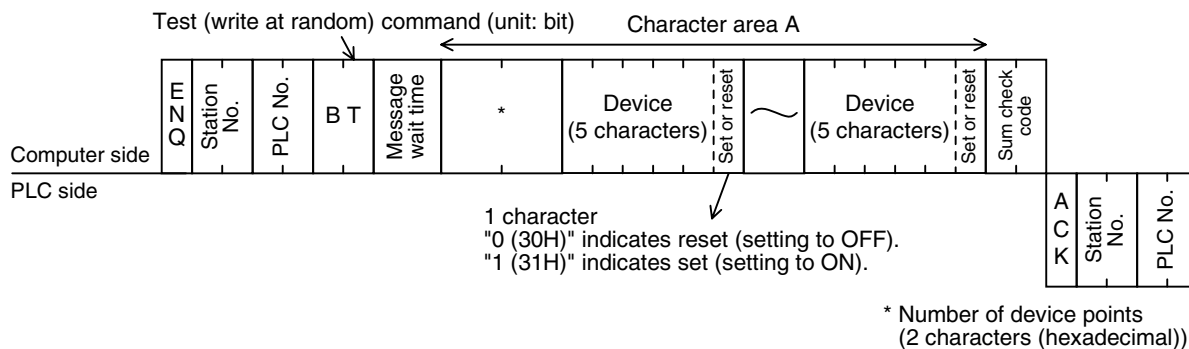

Important points

- 1) Specify the device point range while satisfying the following conditions:
 - $1 \leq \text{Number of device points} \leq 20^{*1}$
- 2) Express the station number, PLC number, number of device points and sum check code in hexadecimal respectively.
 - *1. 10 in the FX1S and FX0N Series

2. Specification example

When writing data for setting M50 to ON, S100 to OFF and Y001 to ON in the PLC whose station number is 5 (while the message waiting time is set to 0 ms)

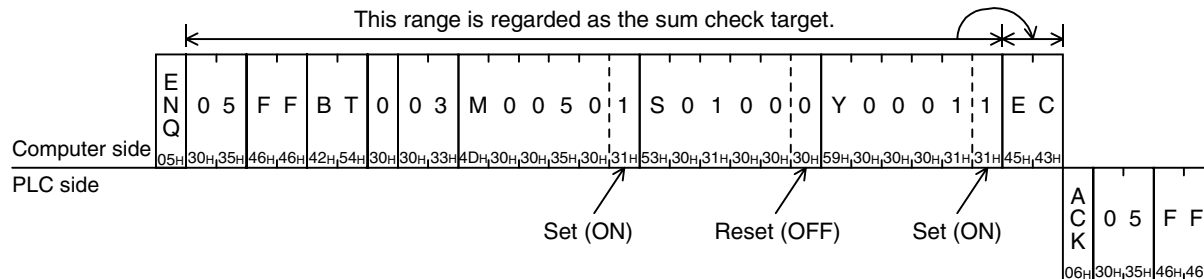

7.8 WT Command [Which Tests Device Memory in Units of Words (by Writing at Random)]

This section explains the control procedure specification method and shows a specification example when the word device memory and bit device memory (in units of 16 points) are specified at random and written at one time.

Word devices and bit devices (in units of 16 points) can be specified together. However, the WT command cannot handle 32-bit word devices C200 to C255 (CN200 to CN255).

1. Specification method

The specification method in the control procedure format 1 is shown below:

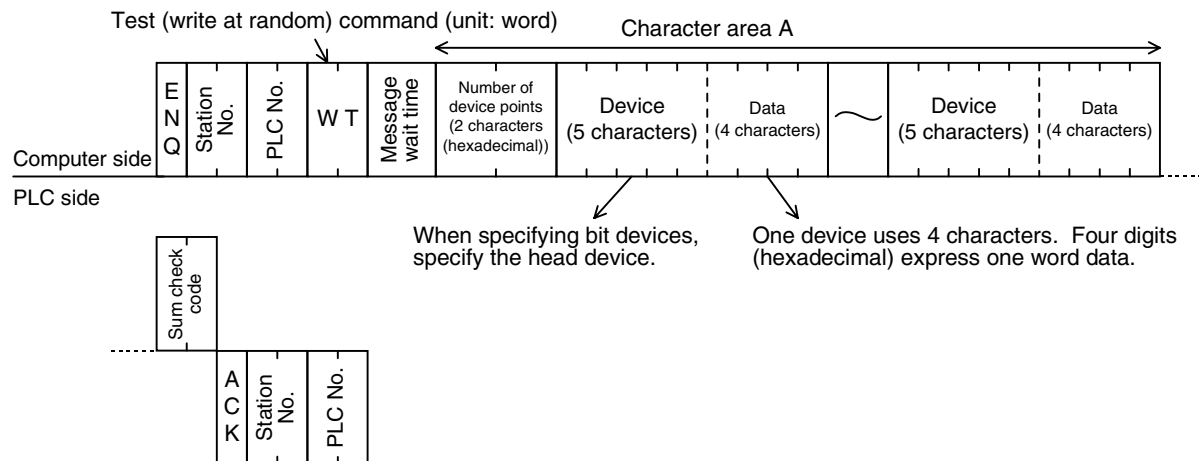

- Specify the device point range while satisfying the following conditions:
 - $1 \leq \text{Number of device points} \leq 10^{*1}$ (in unit of 10^{*1} in case of bit devices (One unit indicates 16 points.))
- Express the station number, PLC number, number of device points and sum check code in hexadecimal respectively.
- The WT command cannot handle 32-bit word devices C200 to C255 (CN200 to CN255).
 - *1. 6 in the FX1S and FX0N Series

2. Specification example

When writing data for setting the current value of D500 to "1234H", Y100 to Y117 to "BCA9H" and the current value of C100 to "64H" in the PLC whose station number is 5 (while the message waiting time is set to 0 ms)

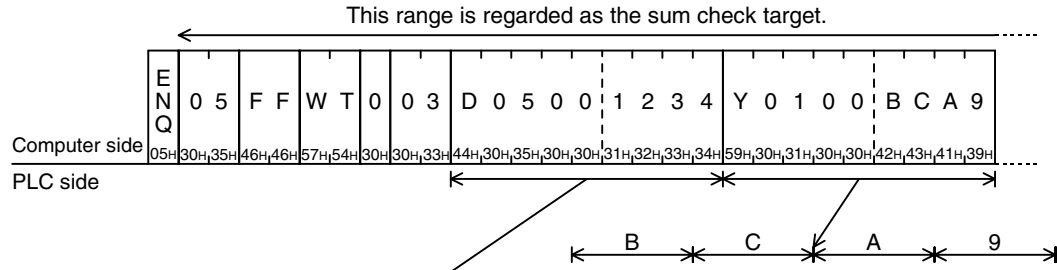

Indicates that "1234H (which is "4660" in decimal)" is written to D500.

1	0	1	1	1	1	0	0	1	0	1	0	1	0	0	1
---	---	---	---	---	---	---	---	---	---	---	---	---	---	---	---

Y	Y	Y	Y	Y	Y	Y	Y	Y	Y	Y	Y	Y	Y	Y	Y
1	1	1	1	1	1	1	1	1	1	1	1	1	1	1	1
1	1	1	1	1	1	1	0	0	0	0	0	0	0	0	0
7	6	5	4	3	2	1	0	7	6	5	4	3	2	1	0

Each bit is reset (OFF) in the case of "0", and set (ON) in the case of "1".

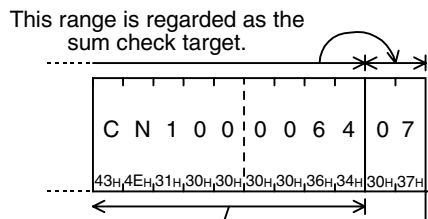

Indicates that "64H (which is "100" in decimal)" is written to the current value of C100.

A	C	0	5	F	F
K	06H	30H	30H	46H	46H

7.9 QT Command [Which Tests Device Memory in Units of Words (by Writing at Random)]

This section explains the control procedure specification method and shows a specification example when the word device memory and bit device memory (in units of 16 points) are specified at random and written at one time.

Word devices and bit devices (in units of 16 points) can be specified together. However, the QT command cannot handle 32-bit word devices C200 to C255 (CN00200 to CN00255).

1. Specification method

The specification method in the control procedure format 1 is shown below:

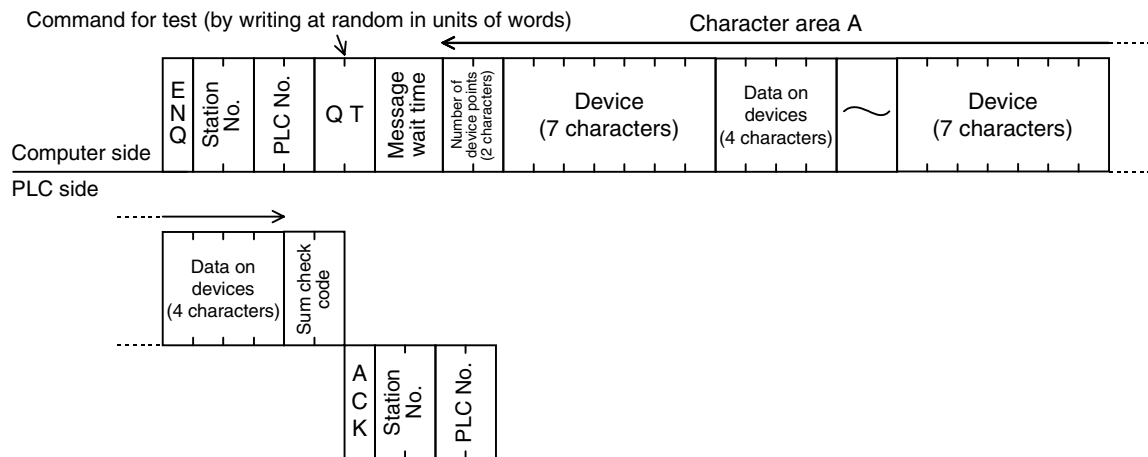

- 1) This command is available only in FX3U and FX3UC PLCs.
- 2) Specify the device point range while satisfying the following conditions:
 - $1 \leq \text{Number of device points} \leq 10$ (in unit of 10 in case of bit devices (One unit indicates 16 points.))
- 3) Express the station number, PLC number, number of device points and sum check code in hexadecimal respectively.
- 4) Word devices and bit devices (in units of 16 points) can be specified together.
- 5) The QT command cannot handle 32-bit word devices C200 to C255 (CN00200 to CN00255).

2. Specification example

When writing data for setting the current value of R12000 to "1234H" and Y100 to Y117 to "BCA9H" in the PLC whose station number is 5 (while the message waiting time is set to 0 ms)

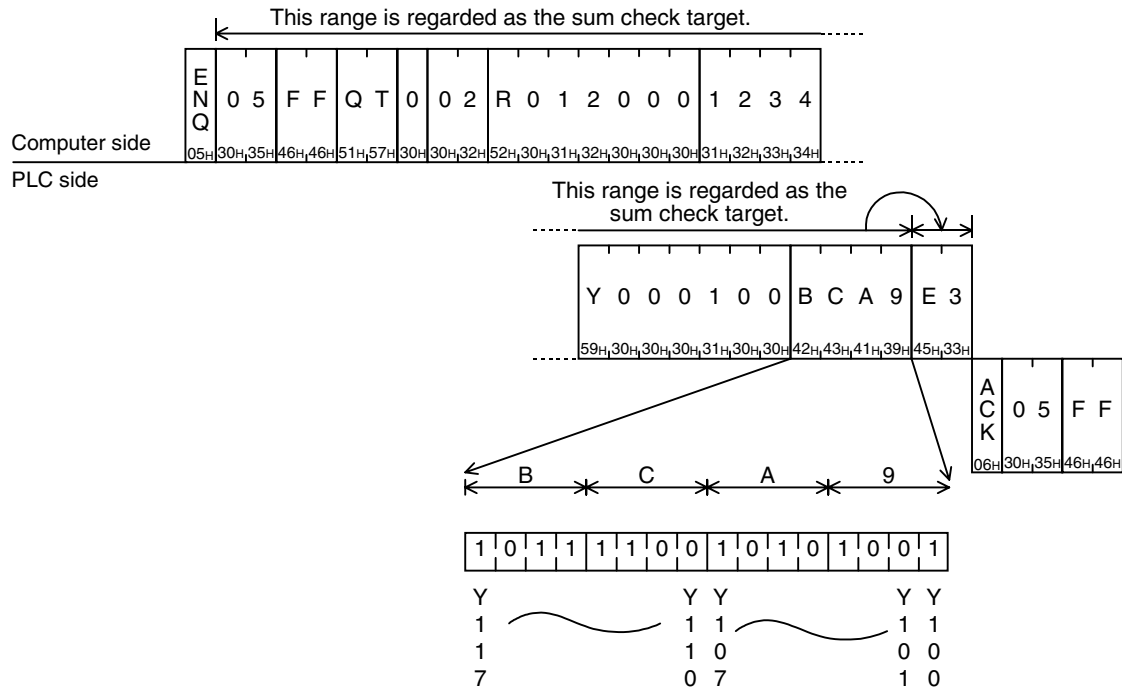

7.10 RR/RS Command [Which Sets PLC to RUN/STOP Mode in Remote Control]

This section explains the control procedure specification method and shows a specification example when the computer sets the PLC mode to RUN or STOP in remote control.

7.10.1 Contents of remote control to set RUN or STOP mode

When the computer executes remote control of the PLC mode to RUN or STOP, the forced RUN mode is activated in the PLC, and the special auxiliary relays M8035, M8036 and M8037 are controlled as follows:

- Remote control to set RUN mode
When the RR command (which sets RUN mode in remote control) is executed in the computer, the PLC sets M8035 and M8036 to activate the forced RUN mode, and becomes RUN mode.
If the RR command is executed while the PLC is in RUN mode, however, the PLC status does not change. And the PLC returns the remote error code (18H) to the computer.
- Remote control to set STOP mode
When the RS command (which sets STOP mode in remote control) is executed in the computer, the PLC executes the following processing.
If the RS command is executed while the PLC is in STOP mode, however, the PLC status does not change. And the PLC returns the remote error code (18H) to the computer.

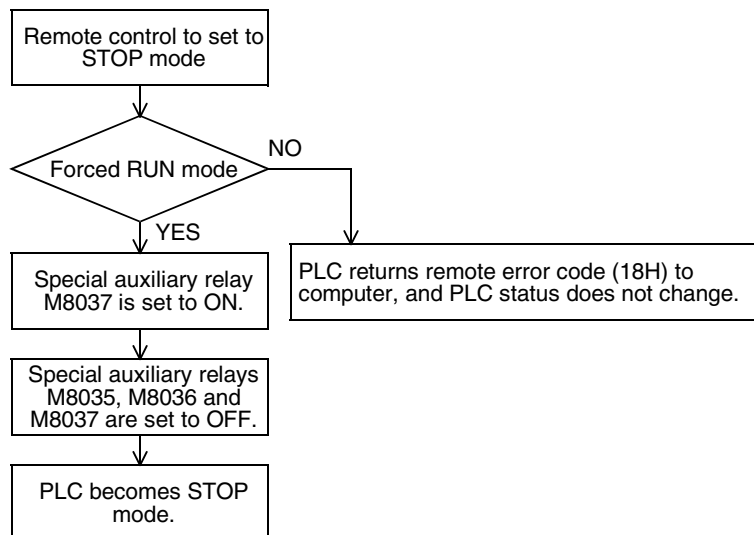

7.10.2 Condition validating remote control to set RUN or STOP mode

- Remote control to set RUN mode
The PLC is in STOP mode.
(The built-in RUN/STOP selector switch is set to STOP.)
(In an FX2(FX) or FX2C PLC, the RUN terminal in the PLC is OFF, and the built-in RUN/STOP selector switch is set to STOP.)
- Remote control to set STOP mode
The PLC is in RUN mode (forced RUN mode) without using the RUN terminal or built-in RUN/STOP selector switch.

Important point

When the PLC power is turned OFF and then ON after the RR command is executed in the computer, all of the special auxiliary relays M8035, M8036 and M8037 are set to OFF. As a result, the PLC turns into STOP mode.

7.10.3 Remote control specification method and specification examples

This subsection explains the control procedure specification method and specification examples when remote control to the RUN or STOP mode is executed.

1. Specification method

The specification method in the control procedure format 1 is shown below:

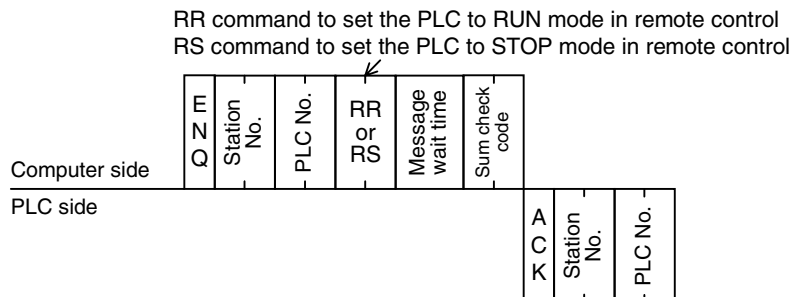

Express the station number, PLC number, number of device points and sum check code in hexadecimal respectively.

2. Specification examples

Example 1: When setting the PLC whose station number is 5 to RUN mode in remote control (while the message waiting time is set to 0 ms)

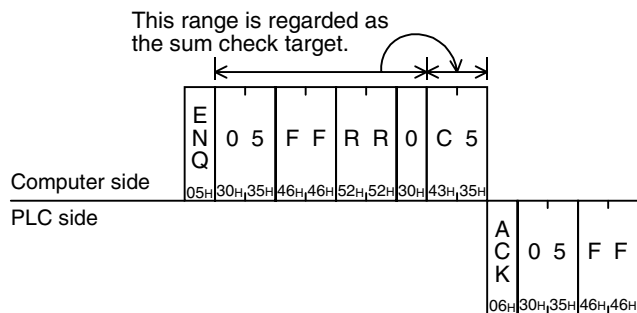

Example 2: When setting the PLC whose station number is 0 to STOP mode in remote control (while the message waiting time is set to 0 ms)

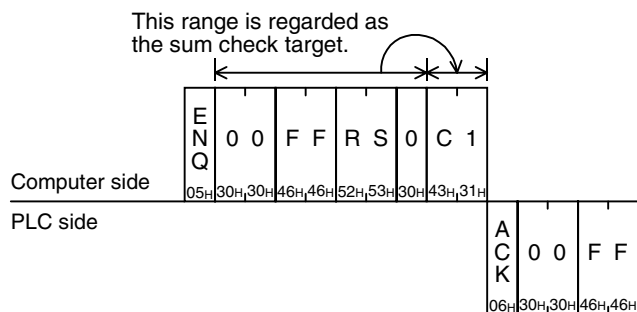

7.11 PC Command [Which Reads PLC Model Name]

This section explains the control procedure specification method and specification example when the model name of a PLC linked to the computer is read.

7.11.1 PLC model name (CPU) and read contents

PLC model name (CPU)	Model name code (hexadecimal)	PLC model name (CPU)	Model name code (hexadecimal)
FX1S	F2H	A2USCPU	82H
FX0N	8EH	A2CPU-S1, A2USCPU-S1	83H
FX2(FX), FX2C	8DH	A3CPU, A3NCPUCPU	A3H
FX1N, FX1NC	9EH	A3ACPU	94H
FX2N, FX2NC	9DH	A3HCPUCPU, A3MCPUCPU	A4H
FX3U, FX3UC	F3H	A3UCPU	84H
A0J2HCPUCPU	98H	A4UCPU	85H
A1CPU, A1NCPUCPU	A1H	A52GCPUCPU	9AH
A1SCPU, A1SJCPUCPU	98H	A73CPUCPU	A3H
A2CPU(-S1), A2NCPUCPU(-S1), A2SCPU	A2H	A7LMS-F	A3H
A2ACPU	92H	AJ72P25/R25	ABH
A2ACPU-S1	93H	AJ72LP25/BR15	8BH
A2CCPU	9AH		

7.11.2 Control procedure specification method and specification example

1. Specification method

The specification method in the control procedure format 1 is shown below:

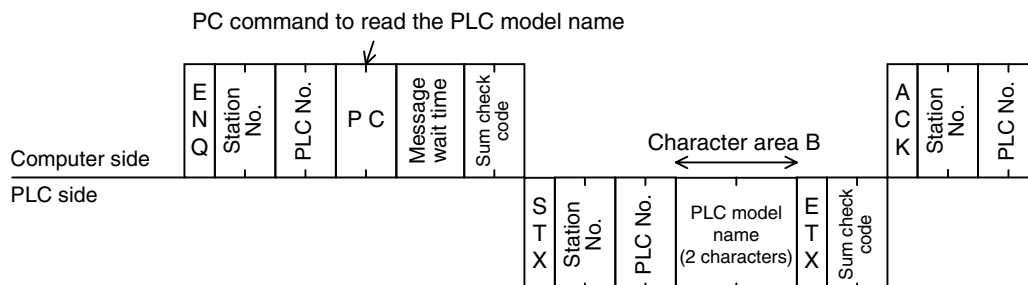

Express the station number, PLC number, number of device points and sum check code in hexadecimal respectively.

2. Specification example

When reading the model name of the PLC whose station number is 15 (while the message waiting time is set to 0 ms)

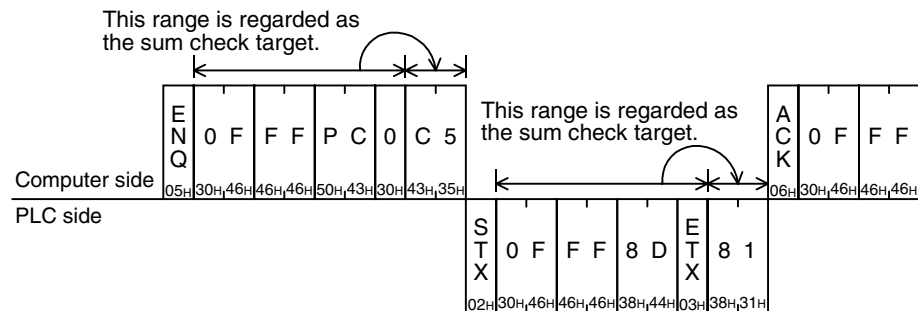

The above example indicates that the model name of the target PLC is the FX2(FX) or FX2C Series.

7.12 GW Command [Which Offers Global Function]

The global function executed in the computer sets to ON or OFF a special auxiliary relay in all PLCs linked to the computer in the multi-drop link method. For A Series PLCs, however, refer to the manual of each A Series PLC.

This section explains the control procedure specification method and specification example when the global function is used.

7.12.1 Contents of control

The global function sets to ON or OFF a special auxiliary relay in all FX Series PLCs linked to the computer. M8126 is set to ON or OFF in PLCs except the FX3U and FX3UC Series.

In FX3U and FX3UC PLCs, M8126 is set to ON or OFF in computer link using ch1, and M8426 is set to ON or OFF in computer link using ch2.

In A Series PLCs, Xn2 is set to ON or OFF in all PLCs linked to the computer.

- In the control procedure, specify the station number "FFH" so that all stations are handled as targets. If any value other than "FFH" is specified, a special auxiliary relay is set to ON or OFF only in a station having the specified station number.
- In this function, PLCs do not give any response to the GW command from the computer.
- When the PLC power is turned OFF or when the PLC is set to STOP mode, the special auxiliary relay M8126 or M8426 is set to OFF and the processing request in the global function is cleared.

7.12.2 Global function control procedure specification method and specification example

This subsection explains the control procedure specification method and specification example when the global function is executed from the computer.

1. Specification method

The specification method in the control procedure format 1 is shown below:

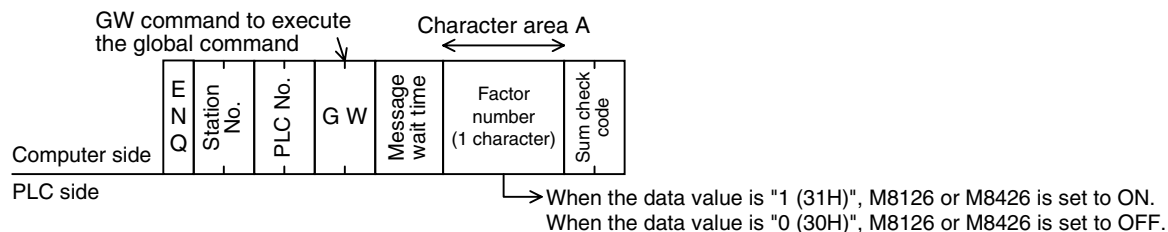

Express the station number, PLC number, number of device points and sum check code in hexadecimal respectively.

2. Specification example

When setting to ON the special auxiliary relay M8126 of M8426 in all FX PLCs (In all of A Series PLCs in computer link, however, Xn2 is set to ON.)

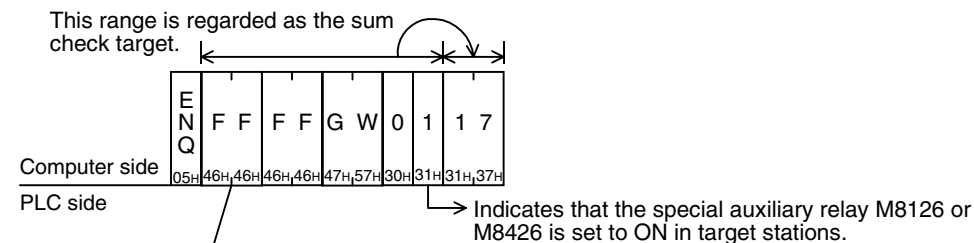

Specify "FFH" for handling all stations as targets.
When handling only one station as a target, specify the station number (in the range from 00 to 0F) of the target station.

7.13 On-demand Function

When there is data to be sent from a PLC to the computer, the on-demand function can specify the data register area storing the data to be sent, and let the PLC start sending.

When data is sent between the computer and a PLC, only the computer can start data transmission.

When there is emergency data to be sent from a PLC to the computer, the on-demand function is applicable to let the PLC begin sending data to the computer.

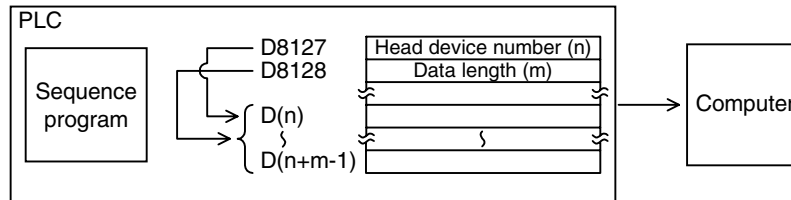

Important point

This function is applicable when the computer and the PLC CPU have the 1-to-1 configuration.

7.13.1 Special data registers and special auxiliary relays used in on-demand function

The tables below show the special data registers and special auxiliary relays used in the on-demand function.

1. In all PLCs except FX3U and FX3UC PLCs and when ch1 is used in FX3U and FX3UC PLCs

Device	Name	Description
M8127	On-demand send processing	Remains ON while the on-demand function is being executed. ON: On-demand data is being sent. OFF: Sending of on-demand data is completed.
M8128	On-demand error flag	Turns ON when an error is included in a specified value to be sent in the on-demand function. ON: Error is included. OFF: Error is not included.
M8129	On-demand byte/word changeover	Specifies the unit (byte or word) of data handled in the on-demand function. ON: Unit = Byte (8-bit) OFF: Unit = Word (16-bit)
D8127	On-demand head device number specification	Sets the head device amount of data registers storing data to be sent in the on-demand function using a sequence program.
D8128	On-demand data quantity specification	Sets the amount of data to be sent in the on-demand function using a sequence program.

2. When ch2 is used in FX3U and FX3UC PLCs

Device	Name	Description
M8427	On-demand send processing	Remains ON while the on-demand function is being executed. ON: On-demand data is being sent. OFF: Sending of on-demand data is completed.
M8428	On-demand error flag	Turns ON when an error is included in a specified value to be sent in the on-demand function. ON: Error is included. OFF: Error is not included.
M8429	On-demand byte/word changeover	Specifies the unit (byte or word) of data handled in the on-demand function. ON: Unit = Byte (8-bit) OFF: Unit = Word (16-bit)
D8427	On-demand head device number specification	Sets the head device amount of data registers storing data to be sent in the on-demand function using a sequence program.
D8428	On-demand data quantity specification	Sets the amount of data to be sent in the on-demand function using a sequence program.

Important points

- The on-demand send processing signal (M8127 or M8427) turns ON when the PLC gives a request to send data to the computer, and turns OFF when sending of the specified data is completed. Use this signal for interlock to prevent giving two or more on-demand requests at the same time.
- While the on-demand send processing signal is ON, the PLC cannot receive commands sent from the computer.
- Number of on-demand data and amount of data registers used for sending according to the unit specification (word or byte)
When the specified unit is a word: The number of on-demand data is equivalent to the amount of data registers for sending.
When the specified unit is a byte: Two on-demand data use one data register for sending.
Example: When the number of on-demand data is "5", the amount of data registers for sending is "3".

7.13.2 Control procedures in on-demand function

This subsection explains the control procedures in the on-demand function. When using ch2 in an FX3U or FX3UC Series PLC, exchange special auxiliary relays (M) and special data registers (D) according to the table below.

All PLCs except FX3U and FX3UC PLCs FX3U and FX3UC PLCs (ch1)		FX3U and FX3UC PLCs (ch2)
M8127	↔	M8427
M8128		M8428
M8129		M8429
D8127		D8427
D8128		D8428

1) Control procedure in the PLC

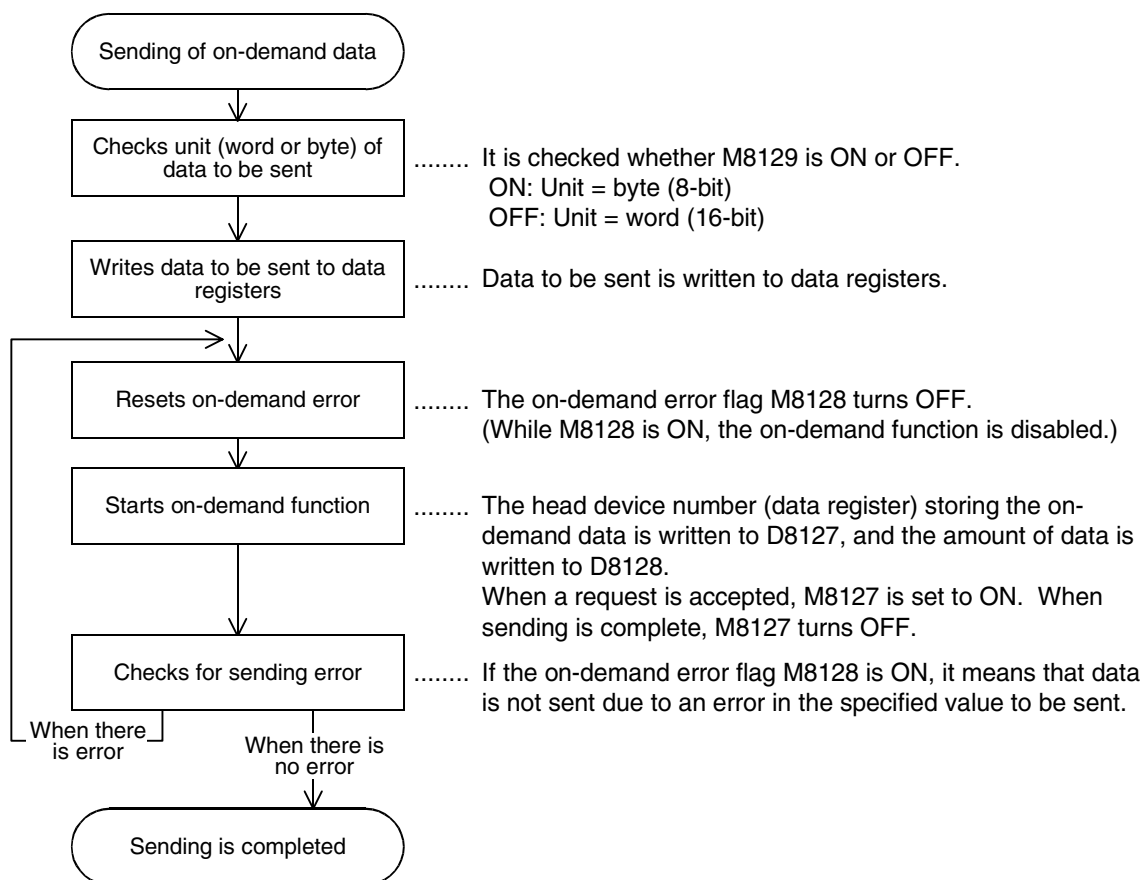

A	Common Items
B	N:N Network
C	Parallel Link
D	Computer Link
E	Inverter Communication
F	Non-Protocol Communication (RS/RS2 Instruction)
G	Non-Protocol Communication (FX2N-232IF)
H	Programming Communication
I	Remote Maintenance

2) Control procedure in the computer

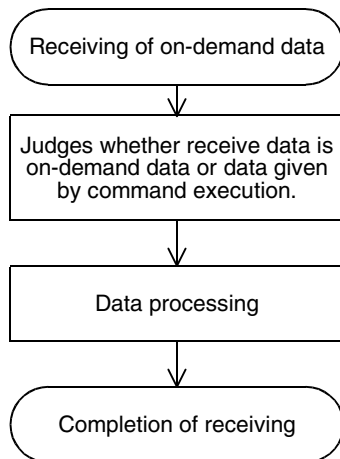

..... To the on-demand data, the PLC adds "FE" as the PLC number. Only when the PLC number of the received data is "FE", the received data should be processed as on-demand data.

3) Time chart when the on-demand function is requested
 While the computer is sending data

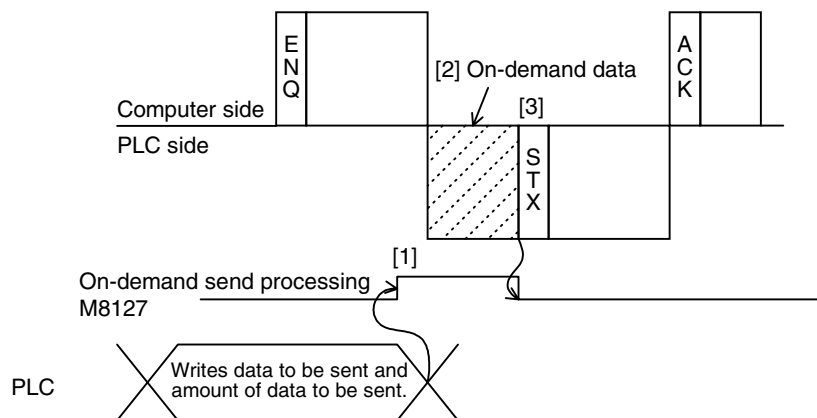

- [1] As soon as an on-demand request is given, the on-demand send processing signal M8127 turns ON.
- [2] After receiving of command data (ENQ ~) from the computer is completed, the PLC sends on-demand data.
- [3] After sending of on-demand data is complete, the PLC sends response data (STX ~) to the command data (ENQ ~).

While the computer is receiving data

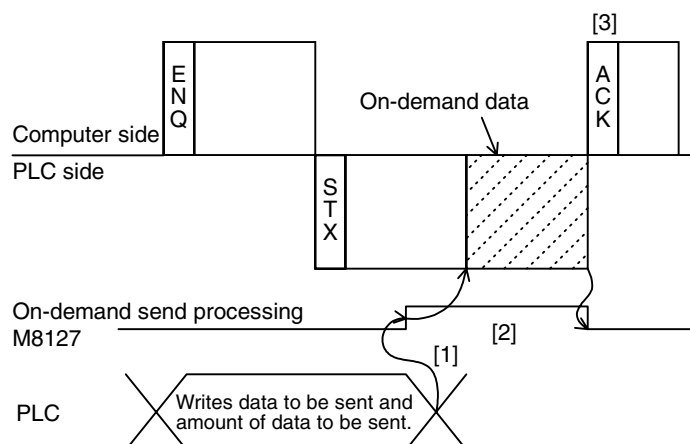

- [1] As soon as an on-demand request is given, the on-demand send processing signal M8127 turns ON.
- [2] After sending of response data (STX ~) to the command data (ENQ ~) from the computer is completed, the PLC sends on-demand data.
- [3] After receiving of on-demand data is complete, the computer sends response data (ACK ~) to the sending of the response data (STX ~) from the PLC.

7.13.3 On-demand function specification method and specification examples

This subsection explains the on-demand function specification method and specification examples. When using ch2 in an FX3U or FX3UC Series PLC, exchange special auxiliary relays (M) and special data registers (D) according to the table below.

All PLCs except FX3U and FX3UC PLCs FX3U and FX3UC PLCs (ch1)		FX3U and FX3UC PLCs (ch2)
M8127	↔	M8427
M8128		M8428
M8129		M8429
D8127		D8427
D8128		D8428

1. Specification method

The specification method in the control procedure format 1 is shown below:

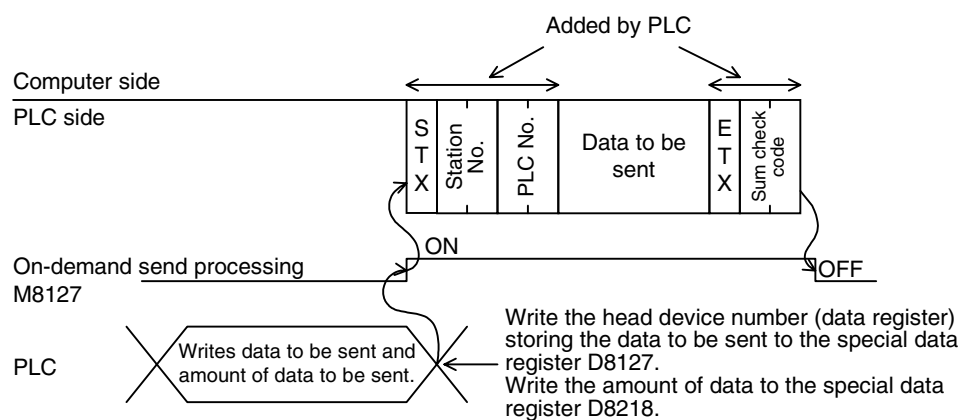

- Specify the data quantity specification range while satisfying the following condition:
 - Amount of data $\leq 40H$ (= 64 in decimal)
- The PLC adds "FE" as the PLC number.
- Express the station number, PLC number, number of device points and sum check code in hexadecimal respectively.

IMPORTANT

Do not use the on-demand function when the system configuration is not 1-to-1 type.
If the on-demand function is used in the multi-drop link system in which the computer and PLC CPUs have the 1-to-N configuration, the transfer data and on-demand send data in the control procedure format 1 or 4 are destroyed, and normal data sending is disabled.

2. Specification example 1

When sending the data stored in the data registers D100 and D101 by a trigger from a sequence program (when the station number is 0 and the data unit to be sent is set to "word")

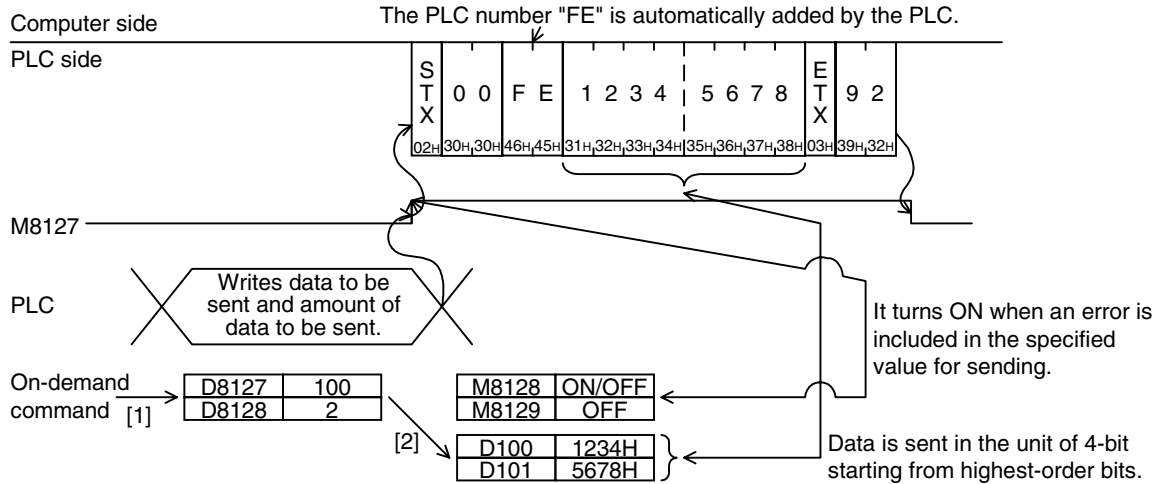

Sequence program example

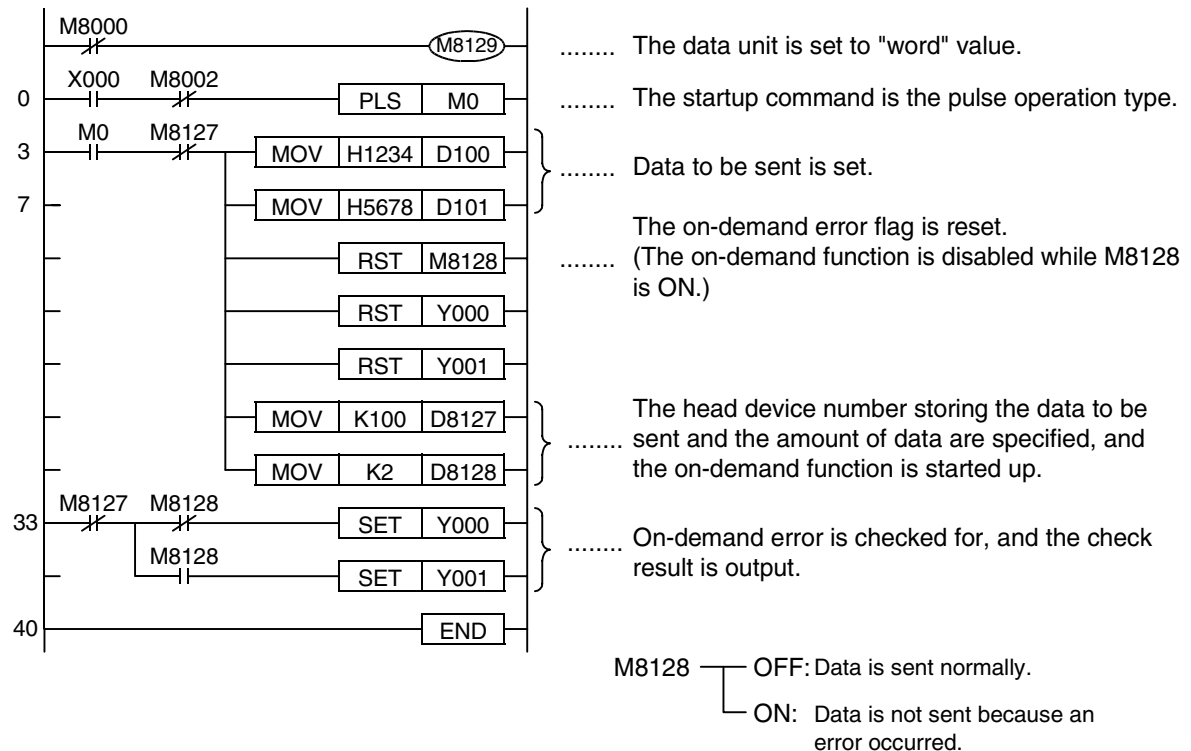

3. Specification example 2

When sending the data stored in the data registers D100 and D101 by a trigger from a sequence program (when the station number is 0 and the data unit to be sent is set to "byte")

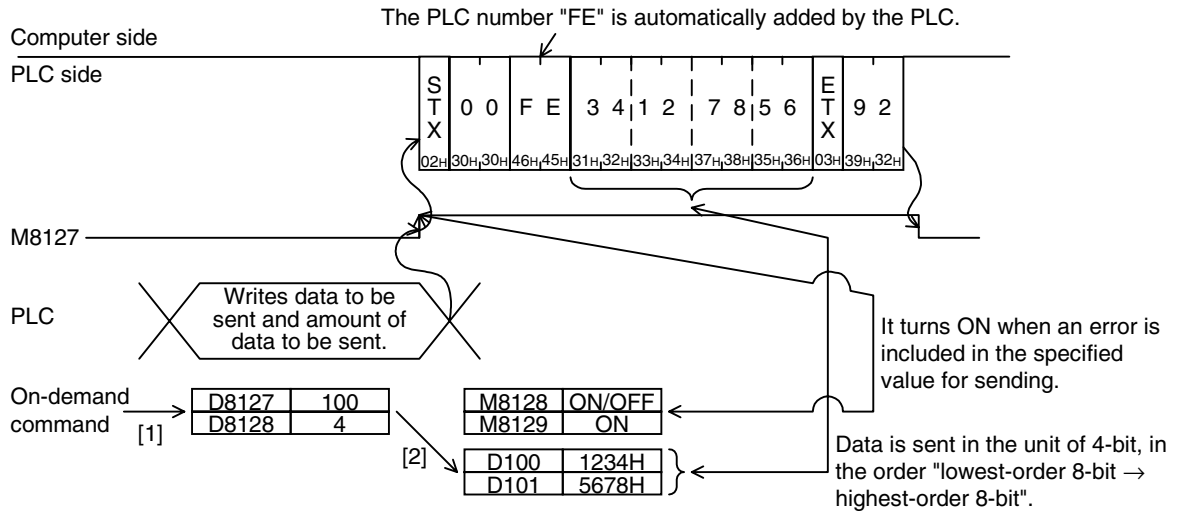

Sequence program example

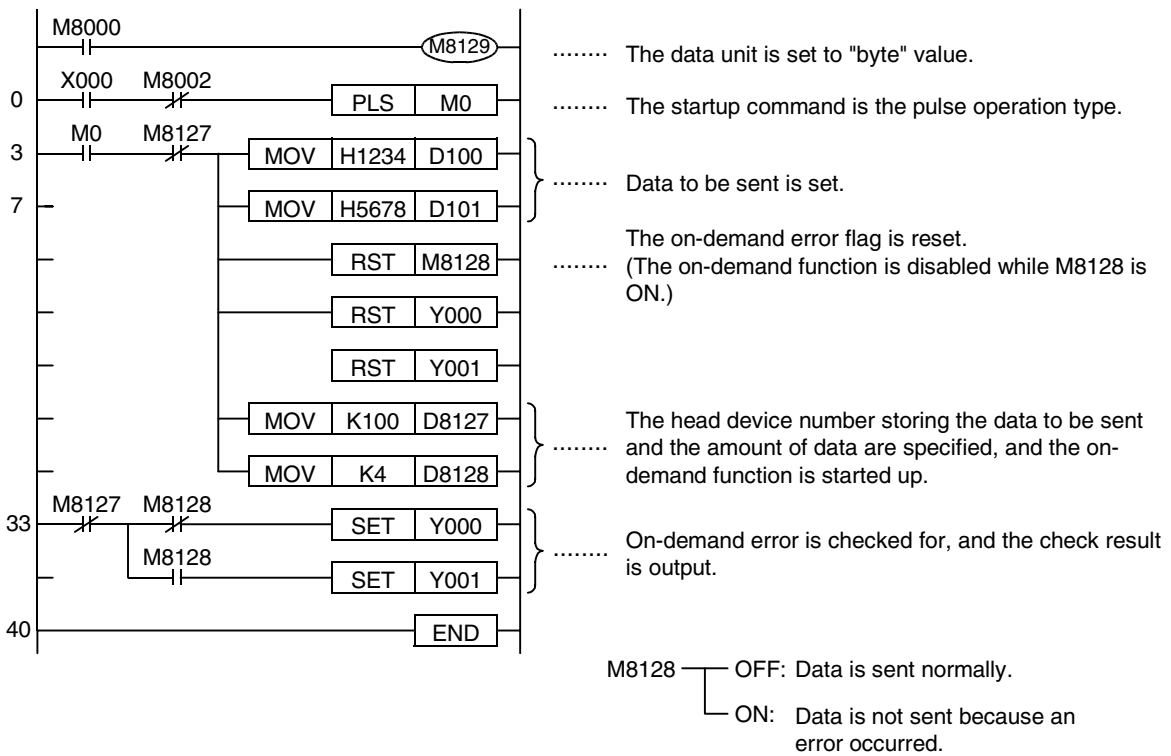

A Common Items
B N:N Network
C Parallel Link
D Computer Link
E Inverter Communication
F Non-Protocol Communication (RS/RS2 Instruction)
G Non-Protocol Communication (FX2N-232IF)
H Programming Communication
I Remote Maintenance

7.14 TT Command [Loop-back Test]

The loop-back test function tests whether communication between the computer and a PLC is normal. This section explains the control procedure specification method and specification example when the loop-back test function is used.

1. Specification method

The specification method in the control procedure format 1 is shown below:

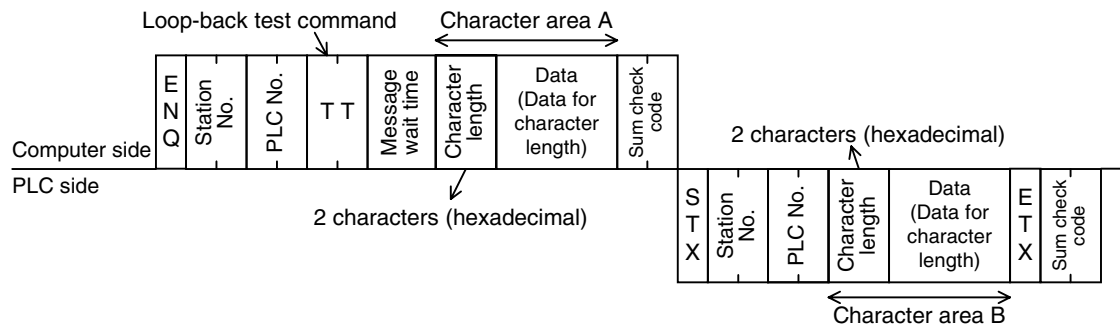

- 1) Specify the character length specification range while satisfying the following condition:
 - $1 \leq \text{Character length} \leq 254$
- 2) Express the station number, PLC number, number of device points and sum check code in hexadecimal respectively.

2. Specification example

When executing the loop-back test to the PLC whose station number is 0 using the data "ABCDE" (while the message waiting time is set to 0 ms)

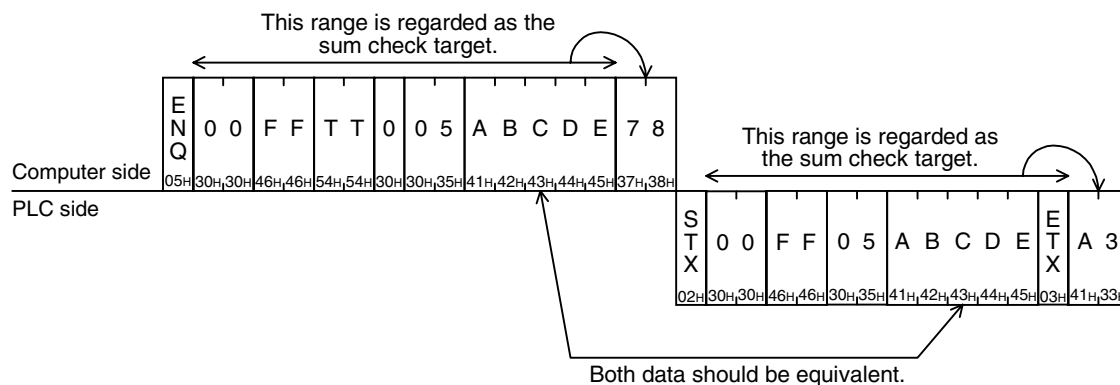

8. Troubleshooting

This chapter explains troubleshooting.

8.1 Checking FX PLC Version Applicability

Verify that the FX PLC main unit is an applicable version.

→ For the version applicability check, refer to Section 1.3.

8.2 Checking Communication Status Based on LED Indication

Check the status of the "RD(RXD)" and "SD(TXD)" indicator LEDs provided in the optional equipment.

LED status		Operation status
RD(RXD)	SD(TXD)	
Flashing	Flashing	Data is being sent or received.
Flashing	Off	Data is received, but is not sent.
Off	Flashing	Data is sent, but is not received.
Off	Off	Data is not sent or received.

While computer link is executed normally, both LEDs flash brightly.

If they do not flash, check the wiring, station number settings and communication setting.

8.3 Checking Installation and Wiring

1. Mounting status

If the communication equipment is not securely connected to the PLC, communication is disabled.

→ For the mounting method, refer to the manual of each communication equipment.

2. Power supply (for FX0N-485ADP)

The FX0N-485ADP requires a driving power supply. Verify that the power supply is provided correctly.

3. Wiring

Verify that the wiring to each communication equipment is correct. Incorrect wiring disables communication.

→ For the wiring method check, refer to Chapter 4.

A

Common Items

B

N:N Network

C

Parallel Link

D

Computer Link

E

Inverter Communication

F

Non-Protocol Communication (RS/RS2 Instruction)

G

Non-Protocol Communication (FX2N-232IF)

H

Programming Communication

I

Remote Maintenance

8.4 Checking Sequence Program

1. Communication setting in a sequence program

Verify that the parallel link and N:N Network are not set. Verify that the communication format (D8120 and D8420) is set correctly. Communication is disabled if a communication port is set to twice or more. After changing any setting, make sure to reboot the PLC's power.

2. Communication setting using parameters

Verify that the communication setting using parameters is suitable to the purpose of use. If the communication setting is not suitable to the purpose of use, communication is not executed correctly. After changing any setting, make sure to reboot the PLC's power.

3. Presence of VRRD and VRSC instructions (in FX3U and FX3UC PLCs)

Verify that VRRD and VRSC instructions are not used in a program. If these instructions are used, delete them, reboot the PLC's power.

4. Presence of RS instruction (except FX3U and FX3UC PLCs)

Verify that RS instruction is not used in a program. If this instruction is used, delete it, reboot the PLC's power.

5. Presence of RS and RS2 instructions (in FX3U and FX3UC PLCs)

Verify that RS and RS2 instructions are not used in the same channel. If these instructions are used in the same channel, delete them, reboot the PLC's power.

6. Presence of EXTR instruction (in FX2N and FX2NC PLCs)

Verify that EXTR instruction is not used in a program. If this instruction is used, delete it, reboot the PLC's power.

7. Presence of IVCK, IVDR, IVRD, IVWR, and IVBWR instructions (in FX3U and FX3UC PLCs)

Verify that IVCK, IVDR, IVRD, IVWR and IVBWR instructions are not used in the same channel. If these instructions are used in the same channel, delete them, reboot the PLC's power.

8.5 Checking Error Codes

8.5.1 Error codes when NAK is sent

The table below shows error codes and contents of errors when NAK is sent in communication between the computer and a PLC.

As an error code, a two-digit ASCII code (hexadecimal) within the range from 00H to FFH is sent.

When two or more errors occur at the same time, priority is given to an error code having the smallest number, and the error code having the smallest number is sent.

When either error shown below occurs, the entire transfer sequence is initialized.

Error code list

Error code (hexadecimal)	Error item	Contents of error	Action
02H	Sum check error	Sum check error has occurred. The sum check code included in the received data is different from the sum value calculated from the received data.	Check the data sent from the computer and the contents of sum check. Modify either one, and then execute communication again.
03H	Protocol error	The communication protocol is abnormal. A control procedure set using parameters was ignored, and a different control procedure was adopted in communication. Or the adopted control procedure was partially different from the preset control procedure. Or a command specified in the preset control procedure does not exist.	<ol style="list-style-type: none"> 1) Check the contents of parameters and the contents of control procedure. Modify either contents, and then execute communication again. 2) Refer to the command list shown in Chapter 7, modify the specified command etc., and then execute communication again.
06H	Character area error	An error occurred in the character area A, B or C. Or a specified command does not exist. <ol style="list-style-type: none"> 1) The control procedure set using parameters is different. 2) A specified device number does not exist in the target PLC. 3) A device number is not set with the specified number of characters (5 or 7 characters). 	<ol style="list-style-type: none"> 1) Check the contents of the character areas A, B and C, modify the contents if necessary, and then execute communication again. 2) Refer to "2.2.2 Applicable device ranges", modify the number of characters used to specify the device number, and then execute communication again.
07H	Character error	ASCII code data to be written to a device is not hexadecimal.	Check the data to be written to the device, modify it if necessary, and then execute communication again.
0AH	PLC number error	A station with the corresponding PLC number does not exist.	Check the PLC number included in the message, modify it if necessary, and then execute communication again. The PLC number should be "FFH" in all FX Series PLCs.
10H	PLC number error	A station with the corresponding PLC number does not exist.	Check the PLC number included in the message, modify it if necessary, and then execute communication again. The PLC number should be "FFH" in all FX Series PLCs.
18H	Remote control error	Remote control to set the RUN or STOP mode is disabled. The RUN or STOP mode is determined in the PLC hardware (by using the RUN/STOP selector switch, etc.).	Set the PLC mode to RUN or STOP using the forced RUN mode.

8.5.2 Error codes in PLC

When an error is included in a message sent from the computer to a PLC, an error occurs in the PLC.

When such an error occurs, the serial communication error flag turns ON.

When PLCs other than FX3U and FX3UC PLCs are used or when ch1 is used in an FX3U or FX3UC PLC, the special auxiliary relay M8063 turns ON as an error flag. When ch2 is used in an FX3U or FX3UC PLC, the special auxiliary relay M8438 turns ON as an error flag.

When a serial communication error occurs, the error code is stored in D8063 if M8063 turns ON, or stored in D8438 if M8438 turns ON.

The error code list is shown below:

Device	Error code	Error item	Contents of error	Action
D8063 (ch1)	6301	Parity, overrun or framing error	The transfer data is abnormal.	Check the transfer specifications set using parameters, and execute communication again.
	6305	Command error	When the station number was FF, any command other than "GW" was received.	Check the specified command, modify it if necessary, and then execute communication again.
	6306	Monitoring timeout	The received message was insufficient. Because normal message was not received within the timeout determination time, the transfer sequence was initialized.	The message is insufficient. Check the transfer program in the computer, modify it if necessary, and then execute communication again.
D8438 (ch2)	3801	Parity, overrun or framing error	The transfer data is abnormal.	Check the transfer specifications set using parameters, and execute communication again.
	3805	Command error	When the station number was FF, any command other than "GW" was received.	Check the specified command, modify it if necessary, and then execute communication again.
	3806	Monitoring timeout	The received message was insufficient. Because normal message was not received within the timeout determination time, the transfer sequence was initialized.	The message is insufficient. Check the transfer program in the computer, modify it if necessary, and then execute communication again.

Error codes are not cleared even if communication errors are reset. They are cleared when the PLC mode is changed from STOP to RUN.

9. Related Data

9.1 Related Device List

1. Bit devices

Device	Name	Description	Attribute
M8063	Serial communication error 1	Turns ON when an error occurs in serial communication using ch 1.	R
M8120	Communication setting keep	Keeps the communication setting status (for FX0N PLCs).	W/R
M8126	Global function ON	Turns ON or OFF when the global command (GW) is received from the computer (for ch. 1).	R
M8127	On-demand send processing	Remains ON while the on-demand function is being executed (for ch.1). ON: On-demand data is being sent. OFF: Sending of on-demand data is completed.	R
M8128	On-demand error flag	Turns ON when an error is included in a specified value for data sending used in the on-demand function (for ch.1).	R
M8129	On-demand data byte/word switch	Specifies the unit (byte or word) of data handled in the on-demand function (for ch.1). ON: Unit = Byte (8-bit) OFF: Unit = Word (16-bit)	W/R
M8426	Global function ON	Turns ON or OFF when the global command (GW) is received from the computer (for ch.2).	R
M8427	On-demand send processing	Remains ON while the on-demand function is being executed (for ch.2). ON: On-demand data is being sent. OFF: Sending of on-demand data is completed.	R
M8428	On-demand error flag	Turns ON when an error is included in a specified value for data sending used in the on-demand function (for ch.2).	R
M8429	On-demand data byte/word switch	Specifies the data unit (byte or word) handled in the on-demand function (for ch.2). ON: Unit = Byte (8-bit) OFF: Unit = Word (16-bit)	W/R
M8438	Serial communication error 2	Turns ON when an error occurs in serial communication using ch 2.	R

R: For reading only W: For writing only

2. Word devices

Device	Name	Description	Attribute
D8063	Serial communication error code 1	Stores an error code when an error occurs in serial communication using ch 1.	R
D8120	Communication format setting	Sets the communication format (for ch.1).	W/R
D8121	Station number settings	Sets the station number in computer link (for ch.1).	W/R
D8127	On-demand data head device number specification	Sets the head device amount of data registers storing data to be sent in the on-demand function (for ch.1).	W/R
D8128	On-demand data quantity specification	Sets the amount of data to be sent in the on-demand function (for ch.1).	W/R
D8129	Timeout determination time setting	Sets the evaluation time for error when receiving of data from the computer is interrupted (for ch.1).	W/R
D8420	Communication format setting	Sets the communication format (for ch.2).	W/R
D8421	Station number settings	Sets the station number in computer link (for ch.2).	W/R
D8427	On-demand data head device number specification	Sets the head device amount of data registers storing data to be sent in the on-demand function (for ch.2).	W/R
D8428	On-demand data quantity specification	Sets the amount of data to be sent in the on-demand function (for ch.2).	W/R
D8429	Timeout determination time setting	Sets the evaluation time for error when receiving of data from the computer is interrupted (for ch.2).	W/R
D8438	Serial communication error code 2	Stores an error code when an error occurs in serial communication using ch 2.	R

R: For reading only W: For writing only

9.2 Details of Related Devices

The devices described below are used in computer link.

9.2.1 Serial communication error [M8063 and M8438]

These devices turn ON when an error occurs in serial communication.

1. Detailed contents

These devices work as the serial communication error flag.

M8063 turns ON when an error occurs in serial communication in any PLC other than FX3U and FX3UC PLCs or in an FX3U or FX3UC PLC using the communication port (ch1).

M8438 turns ON when an error occurs in serial communication in an FX3U or FX3UC PLC using the communication port (ch2).

When serial communication error turns ON, a corresponding error code is stored in D8063 and D8438.

9.2.2 Cautions on use

The serial communication error flag does not turn OFF even after communication recovers its normal status. Clear it by changing the PLC mode from STOP to RUN.

9.2.3 Communication setting keep [M8120]

Set this device to ON in a sequence program so that the communication setting is kept (for FX0N PLCs).

1. Detailed contents

In an FX0N PLC, set M8120 to ON in a sequence program so that the communication format setting and station number settings are kept.

2. Cautions on use

In an FX0N PLC, the communication setting status is kept only when M8120 is set to ON.

In any PLC other than FX0N PLCs, setting of M8120 is not required.

9.2.4 Global function ON [M8126 and M8426]

These devices turn ON/OFF when the PLC receives the global command (GW) from personal computers.

1. Detailed contents

When the computer sends the global command, the global ON flag turns ON or OFF in all connected stations. In all PLCs except FX3U and FX3UC PLCs using the communication port (ch1), M8126 turns ON or OFF.

In FX3U and FX3UC PLCs using the communication port (ch2), M8426 turns ON or OFF.

2. Cautions on use

The global ON flag turns OFF from ON when the PLC power is turned OFF or when the PLC mode is changed to STOP.

9.2.5 On-demand send processing [M8127 and M8427]

These devices remain ON while the on-demand function is being executed.

1. Detailed contents

When a PLC gives data sending request using the on-demand function, the on-demand send processing flag turns ON.

When data sending is complete, the on-demand send processing flag turns OFF.

In all PLCs except FX3U and FX3UC PLCs using the communication port ch.1, M8127 turns ON/OFF.

In FX3U and FX3UC PLCs using the communication port ch.2, M8427 turns ON/OFF.

2. Cautions on use

Use these devices for interlock to prevent generation of two or more on-demand requests at the same time.

A

Common Items

B

N:N Network

C

Parallel Link

D

Computer Link

E

Inverter Communication

F

Non-Protocol Communication (RS/RS2 Instruction)

G

Non-Protocol Communication (FX2N-232IF)

H

Programming Communication

I

Remote Maintenance

9.2.6 On-demand error flag [M8128 and M8428]

These devices turn ON when an error is included in a specified value for data sending used in the on-demand function.

1. Detailed contents

When the number of on-demand data is incorrect, the on-demand error flag turns ON.
In all PLCs except FX3U and FX3UC PLCs using the communication port (ch1), M8128 turns ON.
In FX3U and FX3UC PLCs using the communication port (ch2), M8428 turns ON.

2. Cautions on use

While the on-demand error flag is ON, data sending is disabled in the on-demand function.
When sending data from a PLC using the on-demand function, set to OFF the on-demand error flag.

9.2.7 On-demand data word/byte changeover [M8129 and M8429]

These devices specify the unit (word or byte) of on-demand data.

1. Detailed contents

Use this device to specify the data unit sent in the on-demand function.
Set these devices to ON to specify "byte" (8-bit). Set these devices to OFF to specify "word" (16-bit).
In all PLCs except FX3U and FX3UC PLCs using the communication port (ch1), use M8129.
In FX3U and FX3UC PLCs using the communication port (ch2), use M8429.

2. Cautions on use

When the unit is set to "word", the number of on-demand data is equivalent to the amount of data registers for sending.
When the unit is set to "byte", two on-demand data use one data register for sending.
Example: When the number of on-demand data is "5", the amount of data registers for sending is "3".

9.2.8 Serial communication error code [D8063 and D8438]

These devices store an error code in serial communication.

1. Detailed contents

When the serial communication error flag (M8063 or M8438) turns ON, a corresponding error code is stored in these devices.
In all PLCs except FX3U and FX3UC PLCs using the communication port (ch1), an error code is stored in D8063.
In FX3U and FX3UC PLCs using the communication port (ch2), an error code is stored in D8438.
The error code list is shown below:

Device	Error code	Error item	Contents of error
D8063 (ch1)	6301	Parity, overrun or framing error	The transfer data is abnormal.
	6305	Command error	When the station number was FF, any command other than "GW" was received.
	6306	Monitoring timeout	The received message was insufficient. Because normal message was not received within the timeout determination time, the transfer sequence was initialized.
D8438 (ch2)	3801	Parity, overrun or framing error	The transfer data is abnormal.
	3805	Command error	When the station number was FF, any command other than "GW" was received.
	3806	Monitoring timeout	The received message was insufficient. Because normal message was not received within the timeout determination time, the transfer sequence was initialized.

2. Cautions on use

Error codes are not cleared even after communication recovers its normal status. Clear them by changing the PLC mode from STOP to RUN.

9.2.9 Communication format setting [D8120 and D8420]

These devices set the serial communication format.

1. Detailed contents

These devices set the serial communication format. In FX1S, FX1N, FX2N, FX3U, FX1NC, FX2NC and FX3UC PLCs, the contents set in parameters are transferred to these devices when the power is turned ON.

In FX0N, FX2(FX) and FX2C PLCs, set the communication format using a sequence program, and then turn ON the power.

In all PLCs except FX3U and FX3UC PLCs using the communication port (ch1), use D8120.

In FX3U and FX3UC PLCs using the communication port (ch2), use D8420.

The tables below show the details of setting.

- Contents of D8120

Bit No.	Name	Contents	
		0 (bit = OFF)	1 (bit = ON)
b0	Data length	7-bit	8-bit
b1 b2	Parity	b2, b1 (0, 0): Not provided (0, 1): Odd (1, 1): Even	
b3	Stop bit	1-bit	2-bit
b4 b5 b6 b7	Baud rate (bps)	b7, b6, b5, b4 (0, 0, 1, 1): 300 (0, 1, 0, 0): 600 (0, 1, 0, 1): 1200 (0, 1, 1, 0): 2400	b7, b6, b5, b4 (0, 1, 1, 1): 4800 (1, 0, 0, 0): 9600 (1, 0, 0, 1): 19200
b8	Header	Not provided	Provided (D8124) Initial value: STX (02H)
b9	Terminator	Not provided	Provided (D8125) Initial value: ETX (03H)
b10 b11	Control line	Com-puter link	b11, b10 (0, 0): RS-485/RS-422 interface (1, 0): RS-232C interface
b12		Not applicable	
b13	Sum check	Not added	Added
b14	Protocol	Not used	Used
b15	Control procedure	Format 1	Format 4

• Contents of D8420

Bit No.	Name	Contents	
		0 (bit = OFF)	1 (bit = ON)
b0	Data length	7-bit	8-bit
b1 b2	Parity	b2, b1 (0, 0): Not provided (0, 1): Odd (1, 1): Even	
b3	Stop bit	1-bit	2-bit
b4 b5 b6 b7	Baud rate (bps)	b7, b6, b5, b4 (0, 0, 1, 1): 300 (0, 1, 0, 0): 600 (0, 1, 0, 1): 1200 (0, 1, 1, 0): 2400	b7, b6, b5, b4 (0, 1, 1, 1): 4800 (1, 0, 0, 0): 9600 (1, 0, 0, 1): 19200
b8	Header	Not provided	Provided
b9	Terminator	Not provided	Provided
b10 b11 b12	Control line	Com-puter link	b12, b11, b10 (0, 0, 0): RS-485/RS-422 interface (0, 1, 0): RS-232C interface
b13	Sum check	Not added	Added
b14	Protocol	Not used	Used
b15	Control procedure	Format 1	Format 4

2. Cautions on use

Do not set parameters and communication format setting devices (D8120 or D8420) at the same time. If the communication format is set using both methods at the same time, priority is given to the setting using parameters.

When setting the communication format device (D8120) in an FX0N PLC, set to ON the communication setting latched (battery backed) device (M8120).

When using computer link, make sure to set the header (b8) and terminator (b9) to "not provided." And set the protocol (b14) to "used."

If the communication format is set using a special data register, the setting becomes valid when the power is turned ON after the setting is written to the special data register.

9.2.10 Station number settings [D8121 and D8421]

These devices set the station number in computer link.

1. Detailed contents

Set the station number of each PLC used in computer link. The applicable setting range is from 0 to 15 (from H00 to H0F).

In FX1S, FX1N, FX2N, FX3U, FX1NC, FX2NC and FX3UC PLCs, the contents set using parameters are stored when the power is turned ON.

In FX0N, FX2(FX), and FX2C PLCs, set the station number using a sequence program, and then turn ON the power.

In all PLCs except FX3U and FX3UC PLCs and in FX3U and FX3UC PLCs using the communication port (ch1), use D8121.

In FX3U and FX3UC PLCs using the communication port (ch2), use D8421.

2. Cautions on use

Do not set a parameter and station number settings device (D8121 or D8421) at the same time. If the station number is set using both methods at the same time, priority is given to the setting using a parameter.

When setting the station number settings device (D8121) in an FX0N PLC, set to ON the communication setting latched (battery backed) device (M8120).

9.2.11 On-demand data head device number specification [D8127 and D8427]

These devices set the head device amount of data registers storing data to be sent from a PLC using the on-demand function in a sequence program.

1. Detailed contents

These devices set the head device amount of data registers storing data to be sent using the on-demand function.

In all PLCs except FX3U and FX3UC PLCs and in FX3U and FX3UC PLCs using the communication port (ch1), use D8127.

In FX3U and FX3UC PLCs using the communication port (ch2), use D8427.

If an error is included in the set data, the on-demand error flag (M8128 or M8428) turns ON.

2. Cautions on use

When setting the on-demand data head device number specification device (D8127 or D8427), make the data setting flag into the pulse operation type.

While the on-demand send processing flag (M8127 or M8427) is ON, do not write data.

9.2.12 On-demand data quantity specification [D8128 and D8428]

These devices set, in a sequence program, the amount of data to be sent from a PLC using the on-demand function.

1. Detailed contents

These devices set the amount of data to be sent using the on-demand function. Set the amount of data 64 or less.

In all PLCs except FX3U and FX3UC PLCs using the communication port (ch1), use D8128.

In FX3U and FX3UC PLCs using the communication port (ch2), use D8428.

If an error is included in the set data, the on-demand error flag (M8128 or M8428) turns ON.

2. Cautions on use

When setting the on-demand data quantity specification device (D8128 or D8428), make the data setting flag into the pulse operation type.

While the on-demand send processing flag (M8127 or M8427) is ON, do not write data.

9.2.13 Timeout determination time setting [D8129 and D8429]

These devices set the evaluation time for error when receiving of data from the computer is interrupted.

1. Detailed contents

These devices set the error evaluation time in units of 10 ms used when receiving of data from the computer is interrupted.

In all PLCs except FX3U and FX3UC PLCs using the communication port (ch1), use D8129.

In FX3U and FX3UC PLCs using the communication port (ch2), use D8429.

The table below shows the setting range.

FX Series	Setting range
FX0N, FX1S, FX1N, FX1NC	1 to 255 (10 to 2550 ms) (When "0" is set, it is handled as "100 ms.")
FX2(FX), FX2C, FX2N, FX3U, FX2NC, FX3UC	1 to 3276 (10 to 32760 ms) (When "0" is set, it is handled as "100 ms.")

2. Cautions on use

When setting the timeout determination time setting device (D8129) in an FX0N PLC, set to ON the communication setting latched (battery backed) device (M8120).

Make sure that the timeout determination time is not shorter than the time required to receive one character at the set baud rate.

A	Common Items
B	N:N Network
C	Parallel Link
D	Computer Link
E	Inverter Communication
F	Non-Protocol (RS/R2S Instruction)
G	Non-Protocol (FX2N-232IF)
H	Programming Communication
I	Remote Maintenance

9.3 Communication Setting Method Using Sequence Program

When setting the communication using a sequence program, transfer values to D8120 (communication format), D8121 (station number settings) and D8129 (timeout determination time), and then turn the power ON.

This section explains the communication setting method using a sequence program.

9.3.1 Setting procedure

Perform the following procedure to set the communication using a sequence program.

1 Creating a program using a programming tool

Create the program shown below using a programming tool.

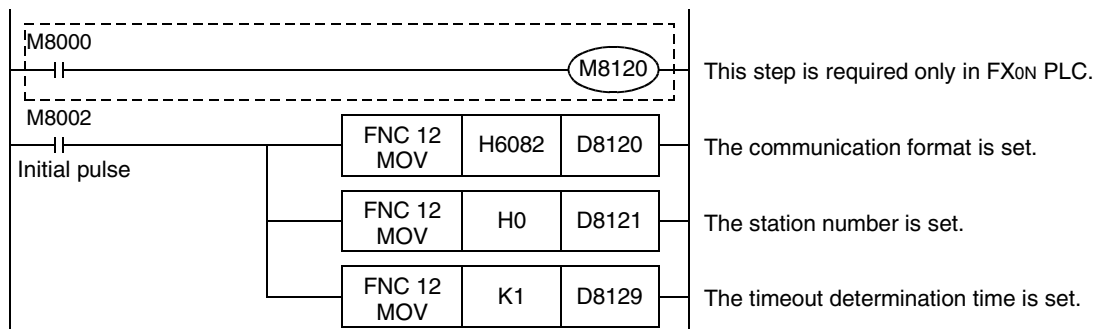

→ For details on these devices, refer to Section 9.2.

2 Writing the sequence program to the PLC

Transfer the created program to the PLC.

3 Setting the PLC mode to RUN

Set the PLC to RUN mode, and execute the program.

4 Turning the PLC power OFF and then ON

Turn OFF the PLC power, and then turn it to ON so that the communication setting becomes valid.

9.3.2 Caution on communication setting using sequence program

Do not set the communication using a sequence program and parameters at the same time. If the communication is set using both methods at the same time, priority is given to the setting using parameters.

9.4 ASCII Code Table

<ASCII code table (8-bit code expressed in hexadecimal)>
The ASCII codes A1H to DFH indicate Japanese characters.

Hexa decimal	0	1	2	3	4	5	6	7	8	9	A	B	C	D	E	F
0		DLE	SP	0	@	P	`	p				-	夕	ミ		
1	SOH	DC1	!	1	A	Q	a	q			。	ア	チ	ム		
2	STX	DC2	"	2	B	R	b	r			「	イ	ツ	メ		
3	ETX	DC3	#	3	C	S	c	s			」	ウ	テ	モ		
4	EOT	DC4	\$	4	D	T	d	t			,	エ	ト	ヤ		
5	ENQ	NAK	%	5	E	U	e	u			.	オ	ナ	ユ		
6	ACK	SYN	&	6	F	V	f	v			ヲ	カ	ニ	ヨ		
7	BEL	ETB	'	7	G	W	g	w			ア	キ	ヌ	ラ		
8	BS	CAN	(8	H	X	h	x			イ	ク	ネ	リ		
9	HT	EM)	9	I	Y	i	y			ウ	ケ	/	ル		
A	LF	SUB	*	:	J	Z	j	z			エ	コ	ハ	レ		
B	VT	ESC	+	;	K	[k	{			オ	サ	ヒ	ロ		
C	FF	FS	,	<	L	\ ^{*1}	l				ヤ	シ	フ	ワ		
D	CR	GS	-	=	M]	m	}			ユ	ス	ハ	ン		
E	SO	RS	.	>	N	^	n	~			ヨ	セ	ホ	。		
F	SI	US	/	?	O	_	o	DEL			ツ	ソ	マ	。		

*1. \ (ASCII CODE:5C) symbol is displayed as "¥" in Japanese.

MEMO

FX Series Programmable Controllers

User's Manual [Inverter Communication]

Foreword

This manual explains "inverter communication" provided in MELSEC-F FX Series Programmable Controllers and should be read and understood before attempting to install or use the unit. Store this manual in a safe place so that you can take it out and read it whenever necessary. Always forward it to the end user.

This manual confers no industrial property rights or any rights of any other kind, nor does it confer any patent licenses. Mitsubishi Electric Corporation cannot be held responsible for any problems involving industrial property rights which may occur as a result of using the contents noted in this manual.

© 2005 MITSUBISHI ELECTRIC CORPORATION

A

Common Items

B

N:N Network

C

Parallel Link

D

Computer Link

E

Inverter Communication

F

Non-Protocol Communication (RS/RS2 Instruction)

G

Non-Protocol Communication (FX2N-232IF)

H

Programming Communication

I

Remote Maintenance

1. Outline

This chapter explains the outline of inverter communication.

1.1 Outline of System

Inverter communication allows connection of an FX PLC and up to eight inverters through communication operating in accordance with RS-485 to monitor operations of inverters, give various commands to inverters and read and write parameters in inverters.

- 1) Mitsubishi general-purpose inverters FREQROL F700, A700, V500, F500, A500, E500 and S500 (containing the communication type) Series can be linked.
 (F700, A700, V500 and F500 Series inverters can be connected only to FX3U and FX3UC PLCs.)
- 2) Operations of inverters can be monitored, various command can be given to inverters, and parameters can be read or written in inverters.
- 3) The total extension distance is 500m (1640' 5") maximum (when only 485ADP is adopted in the configuration).

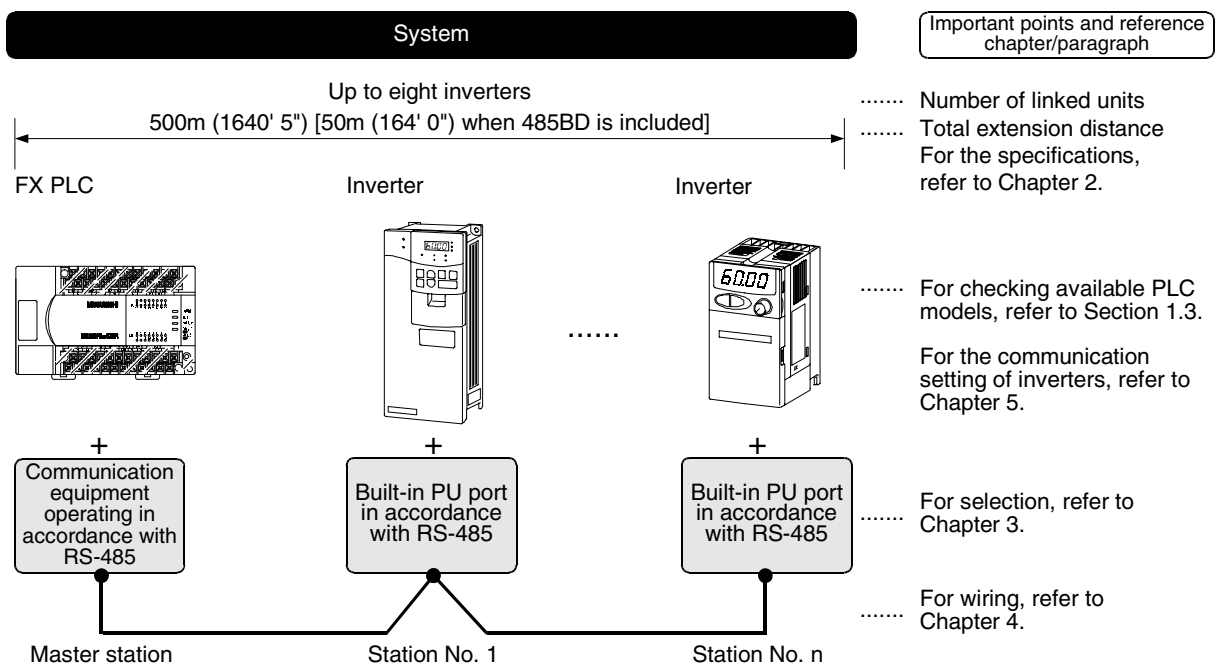

A	Common Items
B	N:N Network
C	Parallel Link
D	Computer Link
E	Inverter Communication
F	Non-Protocol Communication (RS/RS2 Instruction)
G	Non-Protocol Communication (FX2N-232IF)
H	Programming Communication
I	Remote Maintenance

1.2 Major Procedures until Operation

The flow chart below shows the procedures for setting inverter communication and creating sequence programs until data link:

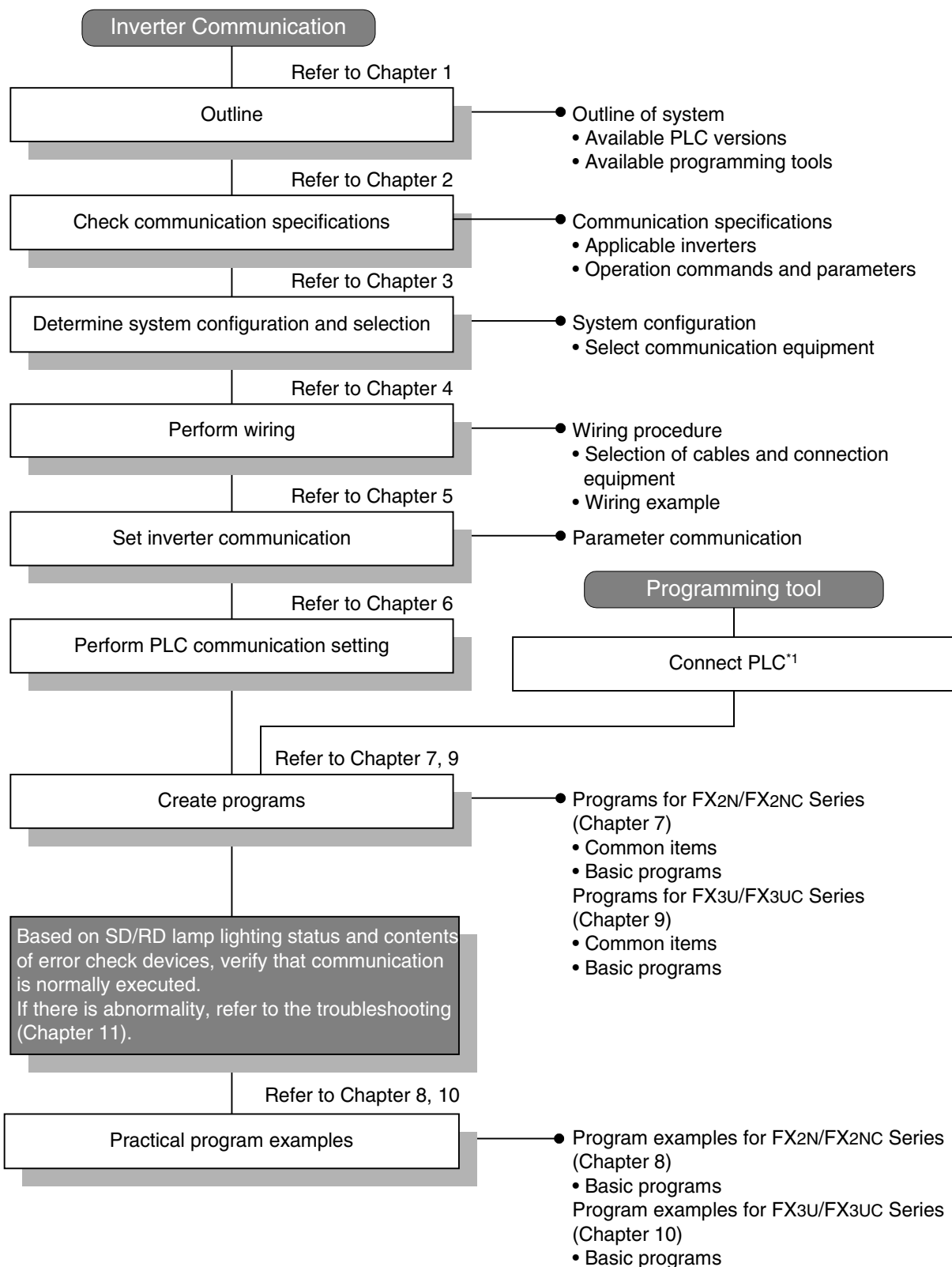

*1 For the method to connect a programming tool to the PLC, refer to the "Programming Communication" in this manual or the manual of each programming tool.
 For details on operation method, refer to the manual of each programming tool.

1.3 Communication Type Applicability in PLC

1.3.1 For applicable versions

The communication types are applicable in the following versions.

- ✓: Applicable (If applicable versions are limited, they are described inside ().)
- : Not applicable

PLC	Applicability (applicable version)	Remarks
FX3UC Series	✓*1	F700, A700, V500, F500, A500, E500 and S500 (having the communication type) Series inverters can be connected.
FX3U Series	✓	
FX2NC Series	✓ (Ver. 3.00 or later)*2	A500, E500 and S500 (having the communication function) Series inverters can be connected.
FX2N Series	✓ (Ver. 3.00 or later)*2	
FX1NC Series	—	Inverter communication is not provided.
FX1N Series	—	Inverter communication is not provided.
FX1S Series	—	Inverter communication is not provided.
FX0N Series	—	Inverter communication is not provided.
FX0s Series	—	Inverter communication is not provided.
FX0 Series	—	Inverter communication is not provided.
FX2c Series	—	Inverter communication is not provided.
FX2(FX) Series	—	Inverter communication is not provided.
FX1 Series	—	Inverter communication is not provided.

- *1. F700 and A700 Series inverters are supported in Ver. 2.20 and later.
 Product manufactured in May, 2005 (manufacturer's serial number: 55****)
- *2. Applicable in products manufactured in May, 2001 (manufacturer's serial No.: 15****) and later.

1. Version check

The D8001(decimal) special data register contains information for determining the PLC version.

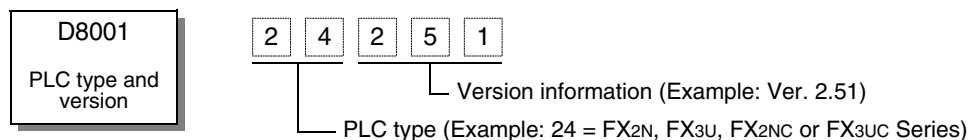

2. How to look at the manufacturer's serial number

The year and month of production of product can be seen from the Manufacturer's serial number "SERIAL" indicated on the label adhered to the right side of the product.

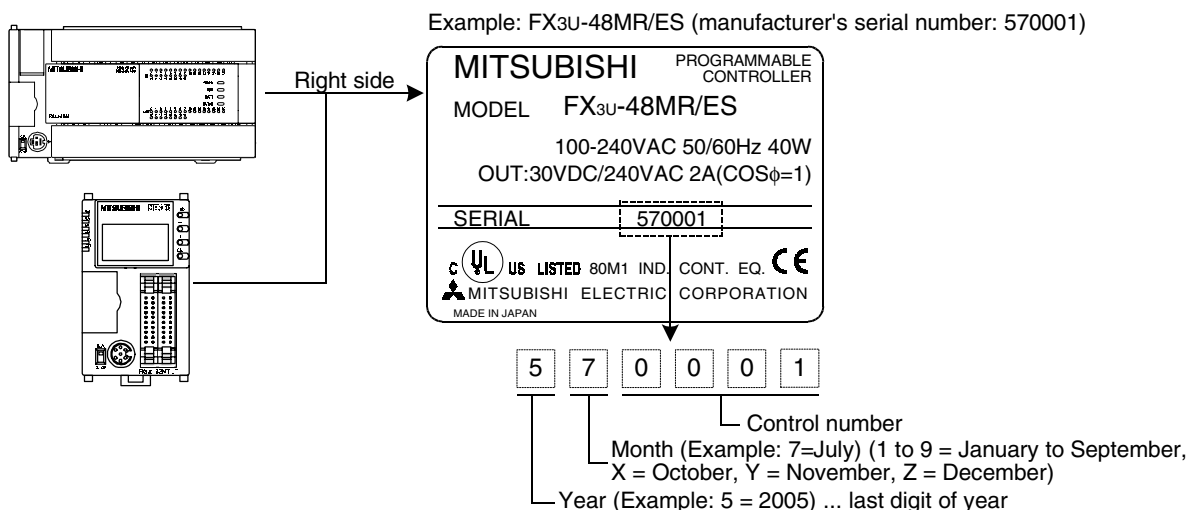

A	Common Items
B	N:N Network
C	Parallel Link
D	Computer Link
E	Inverter Communication
F	Non-Protocol Communication (RS/RS2 Instruction)
G	Non-Protocol Communication (FX2N-232IF)
H	Programming Communication
I	Remote Maintenance

1.4 Programming Tool Applicability

1.4.1 For applicable versions

The programming tool is applicable in each FX Series from the following version:

1. Japanese versions

✓: Applicable (If applicable versions are limited, they are described inside ().)
 —: Not applicable

Model name (Media model name is shown below)	Applicability (applicable version)	Remarks
FX3u and FX3uc PLCs		
GX Developer SW□D5C(F)-GPPW-J	✓ (Ver. SW8 P or later) Ver.8.13P	Select the model "FX3UC"
FX2N and FX2Nc PLCs		
GX Developer SW□D5C(F)-GPPW-J	✓ (Ver. SW7 A or later)	Select the model "FX2N/FX2Nc" The versions shown on the left supporting EXTR instruction are applicable
FX-PCS/WIN SW0PC-FXGP/WIN	✓ (Ver. 4.20 or later)	
FX-20P(-SET0) FX-20P-MFXD	✓ (Ver. 5.10 or later)	
FX-10P(-SET0)	✓ (Ver. 4.10 or later)	
GOT-F900 Series display units F940WGOT-TWD F940GOT-*WD F940GOT-*BD-H F940GOT-*BD-RH	✓ (Refer to right column.)	F940WGOT-TWD (Ver. 1.30 or later) F940GOT-LWD, F940GOT-SWD (Ver. 6.30 or later) F940GOT-LBD-H, F940GOT-SBD-H (Ver. 6.30 or later) F940GOT-LBD-RH, F940GOT-SBD-RH (Ver. 6.30 or later)

2. English versions

✓: Applicable (If applicable versions are limited, they are described inside ().)
 —: Not applicable

Model name (Media model name is shown below)	Applicability (applicable version)	Remarks
FX3u and FX3uc PLCs		
GX Developer SW□D5C(F)-GPPW-E	✓ (Ver. SW8 P or later) Ver.8.13P	Select the model "FX3UC"
FX2N and FX2Nc PLCs		
GX Developer SW□D5C(F)-GPPW-E	✓ (Ver. SW7 A or later)	Select the model "FX2N/FX2Nc" The versions shown on the left supporting EXTR instruction are applicable
FX-PCS/WIN-E SW0PC-FXGP/WIN-E	✓ (Ver. 3.10 or later)	
FX-20P-E(-SET0) FX-20P-MFXD-E	✓ (Ver. 4.10 or later)	
FX-10P-E	✓ (Ver. 4.10 or later)	
GOT-F900 Series display units F940WGOT-TWD-E F940GOT-*WD-E F940GOT-*BD-H-E F940GOT-*BD-RH-E	✓ (Refer to right column)	F940WGOT-TWD-E (Ver. 1.30 or later) F940GOT-LWD-E, F940GOT-SWD-E (Ver. 6.30 or later) F940GOT-LBD-H-E, F940GOT-SBD-H-E (Ver. 6.30 or later) F940GOT-LBD-RH-E, F940GOT-SBD-RH-E (Ver. 6.30 or later)

1.4.2 For non-applicable versions (setting an alternative model)

Programming is disabled using software of non-applicable version.

2. Specifications

This chapter explains the communication specifications and performance.

2.1 Communication Specifications (Reference)

Item	Specifications	Remarks
Number of connectable units	8 maximum	
Transmission standard	RS-485 standard	
Maximum total extension distance	500 m (1640' 5") or less when 485ADP is used 50 m (164' 0") or less when 485BD is used	Distance varies depending on communication equipment type.
Protocol type	Inverter computer link	Link startup mode
Control procedure	Asynchronous system	
Communication method	Half-duplex, bidirectional communication	
Baud rate	4800, 9600 or 19200 bps	Either one can be selected.
Character format	ASCII	
Start bit	—	
Data bit	7-bit	
Parity bit	Even	
Stop bit	1-bit	

2.2 Connectable Mitsubishi General-purpose Inverters

Series	Built-in PU connector	FR-A5NR (option)	Remarks
FREQROL S500	✓	—	Only models having the RS-485 communication type can be connected.
FREQROL E500	✓	—	
FREQROL A500	✓	✓	
FREQROL F500	✓	✓	
FREQROL V500	✓	✓	
Series	Built-in PU connector	Built-in RS-485 terminal	Remarks
FREQROL A700	—	✓	They can be connected only to FX3U and FX3UC*1 PLCs.
FREQROL F700	—	✓	

*1. F700 and A700 Series inverters are supported in Ver. 2.20 and later.

2.3 Link Specifications

The tables below show applicable parameters and operation commands.

2.3.1 When monitoring inverter operations (PLC ← inverter)

Instruction code (hexadecimal)	Read contents	Applicable inverter						
		F700	A700	V500	F500	A500	E500	S500
H7B	Operation mode	✓	✓	✓	✓	✓	✓	✓
H6F	Output frequency [number of rotations]	✓	✓	✓	✓	✓	✓	✓
H70	Output current	✓	✓	✓	✓	✓	✓	✓
H71	Output voltage	✓	✓	✓	✓	✓	✓	—
H72	Special monitor	✓	✓	✓	✓	✓	—	—
H73	Special monitor selection number	✓	✓	✓	✓	✓	—	—
H74	Alarm definition	✓	✓	✓	✓	✓	✓	✓
H75	Alarm definition	✓	✓	✓	✓	✓	✓	✓
H76	Alarm definition	✓	✓	✓	✓	✓	✓	—
H77	Alarm definition	✓	✓	✓	✓	✓	✓	—
H79	Inverter status monitor (extended)	✓	✓	—	—	—	—	—
H7A	Inverter status monitor	✓	✓	✓	✓	✓	✓	✓
H6E	Set frequency (EEPROM)	✓	✓	✓	✓	✓	✓	✓
H6D	Set frequency (RAM)	✓	✓	✓	✓	✓	✓	✓

2.3.2 When controlling inverter operations (PLC → inverter)

Instruction code (hexadecimal)	Written contents	Applicable inverter						
		F700	A700	V500	F500	A500	E500	S500
HFB	Operation mode	✓	✓	✓	✓	✓	✓	✓
HF3	Special monitor selection number	✓	✓	✓	✓	✓	—	—
HF9	Run command (extended)	✓	✓	—	—	—	—	—
HFA	Run command	✓	✓	✓	✓	✓	✓	✓
HEE	Set frequency (EEPROM)	✓	✓	✓	✓	✓	✓	✓
HED	Set frequency (RAM)	✓	✓	✓	✓	✓	✓	✓
HFD	Inverter reset	✓	✓	✓	✓	✓	✓	✓
HF4	Alarm definition all clear	✓	✓	—	✓	✓	✓	✓
HFC	All parameter all clear	✓	✓	✓	✓	✓	✓	✓
HFC	User clear	✓	✓	—	✓	✓	—	—

2.3.3 Parameters (PLC ↔ inverter)

For parameters in inverters which can be changed (read and written), refer to "12. Related Detailed Data" later.

3. System Configuration and Selection

This chapter explains the configuration of communication equipment operating in accordance with RS-485 and selection of the system required by FX PLCs.

3.1 System Configuration

This section explains the outline of the system configuration required to use inverter communication. Connect (optional) equipment operating in accordance with RS-485 to the FX PLC main unit.

1 **2** **3** **4** and **5** indicate the pattern types of combination of communication equipment.

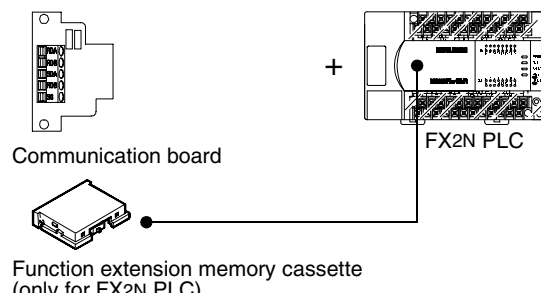
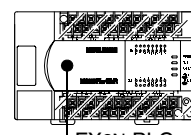
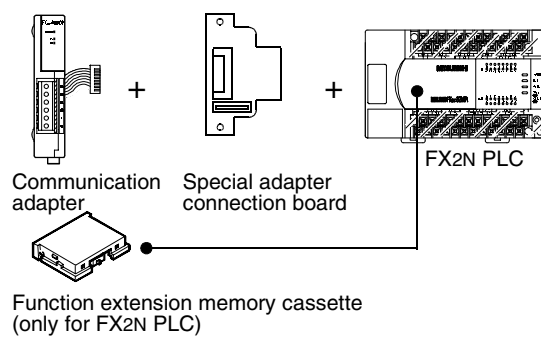
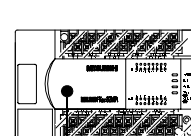
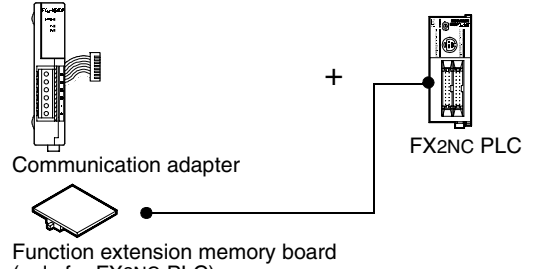
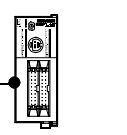
	Communication equipment operating in accordance with RS-485	FX PLC	Important point in selection	Total extension distance
1	 <p>Communication board</p> <p>Function extension memory cassette (only for FX2N PLC)</p>	 <p>FX2N PLC</p>	<p>Because it can be built inside a PLC, the installation area is not changed.</p>	<p>50 m (164' 0")</p>
2	 <p>Communication adapter</p> <p>Special adapter connection board</p> <p>Function extension memory cassette (only for FX2N PLC)</p>	 <p>FX2N PLC</p>	<p>Attach the special adapter connection board to the main unit, and then attach the communication adapter to the left side of the main unit.</p>	<p>500 m (1640' 5")</p>
3	 <p>Communication adapter</p> <p>Function extension memory board (only for FX2NC PLC)</p>	 <p>FX2NC PLC</p>	<p>Attach the communication adapter to the left side of the main unit.</p>	<p>500 m (1640' 5")</p>

A	Common Items
B	N:N Network
C	Parallel Link
D	Computer Link
E	Inverter Communication
F	Non-Protocol Communication (RS/RS2 Instruction)
G	Non-Protocol Communication (FX2N-232IF)
H	Programming Communication
I	Remote Maintenance

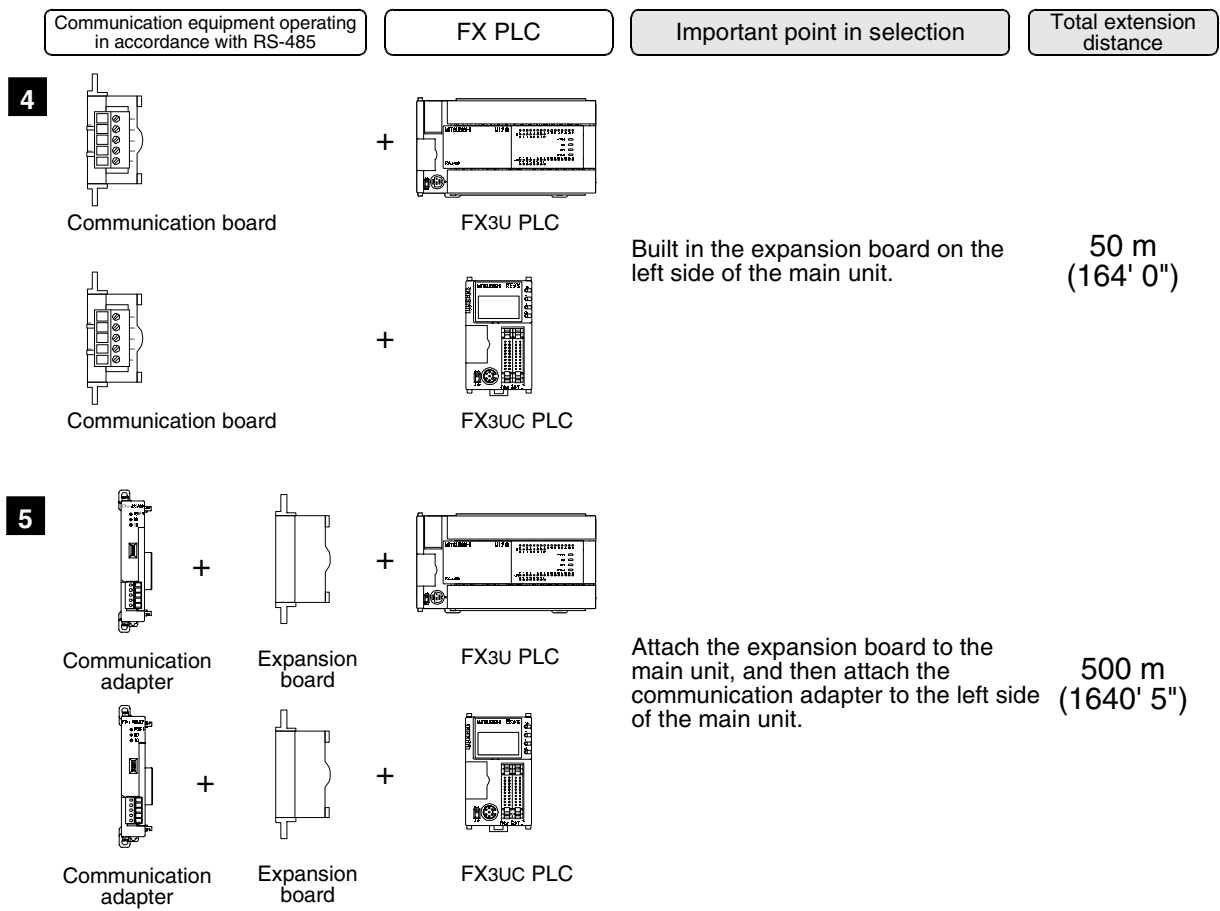





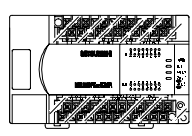
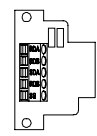
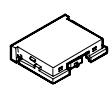
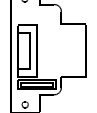
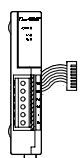
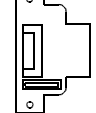
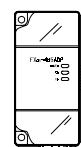

For combination of communication equipment for each FX Series, refer to the next section.

3.2 Applicable FX PLC and Communication Equipment

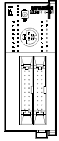

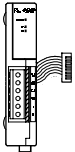
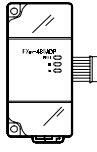
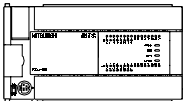
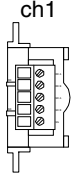
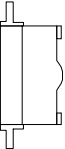
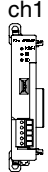

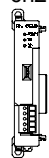
Select a combination of (optional) communication equipment, and put a check mark in the "Check" column. During selection, pay attention to the following:

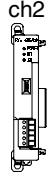
- In the table below, only the external dimensions are different between units of shown in "485ADP/485ADP". Select either one.
- Inverter communication is not provided in the FX0, FX0S, FX0N, FX1, FX2(FX), FX2C, FX1S, FX1N, and FX1NC Series.

FX Series	Communication equipment (option)	Total extension distance	Check
 FX2N	 FX2N-485-BD	50 m (164' 0")	
+  FX2N-ROM-E1 (Function extension memory cassette)	 +  /  +  FX2N-CNV-BD FX2NC-485ADP (European terminal block) FX2N-CNV-BD FX0N-485ADP (Terminal block)	500 m (1640' 5")	

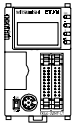
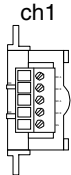
FX Series	Communication equipment (option)	Total extension distance	Check
 FX2NC +  FX2NC-ROM-CE1 (Function extension memory board)	 FX2NC-485ADP (European terminal block)  FX0N-485ADP (Terminal block)	500 m (1640' 5")	
 FX3U	When using channel 1 (ch 1)		
	 ch1 FX3U-485-BD (European terminal block)	50 m (164' 0")	
	 FX3U-CNV-BD +  ch1 FX3U-485ADP (European terminal block)	500 m (1640' 5")	
	When using channel 2 (ch 2)		
	 ch1 FX3U-□-BD (One is put in □ among 232, 422, 485, and USB). +  ch2 FX3U-485ADP (European terminal block)	500 m (1640' 5")	
 FX3U-CNV-BD +  ch1 FX3U-□ADP (One is put in □ among 232 and 485). +  ch2 FX3U-485ADP (European terminal block)	500 m (1640' 5")		

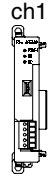
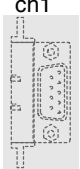
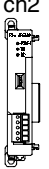
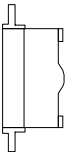
A	Common Items
B	N:N Network
C	Parallel Link
D	Computer Link
E	Inverter Communication
F	Non-Protocol Communication (RS/RS2 Instruction)
G	Non-Protocol Communication (FX2N-232IF)
H	Programming Communication
I	Remote Maintenance

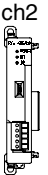
FX Series	Communication equipment (option)	Total extension distance	Check
 <p>FX3UC</p>	When using channel 1 (ch 1)		
	 <p>ch1</p> <p>FX3U-485-BD (European terminal block)</p>	50 m (164' 0")	
	 <p>FX3U-CNV-BD</p> <p>+</p>  <p>ch1</p> <p>FX3U-485ADP (European terminal block)</p>	500 m (1640' 5")	
	When using channel 2 (ch 2)		
	 <p>ch1</p> <p>FX3U-□-BD (One is put in □ among 232, 422, 485, and USB).</p> <p>+</p>  <p>ch2</p> <p>FX3U-485ADP (European terminal block)</p>	500 m (1640' 5")	
	 <p>FX3U-CNV-BD</p> <p>+</p>  <p>ch1</p> <p>FX3U-□-ADP (One is put in □ among 232 and 485).</p> <p>+</p>  <p>ch2</p> <p>FX3U-485ADP (European terminal block)</p>	500 m (1640' 5")	

4. Wiring

This chapter explains the wiring.

WIRING PRECAUTIONS	 DANGER
<ul style="list-style-type: none"> • Cut off all phases of the power source externally before installation or wiring work in order to avoid electric shock or damage of product. • Make sure to attach the terminal cover offered as an accessory to the product before turning on the power or starting the operation after installation or wiring work. Failure to do so may cause electric shock. 	

WIRING PRECAUTIONS	 CAUTION
<ul style="list-style-type: none"> • Make sure to observe the precautions below in order to prevent any damage to the machine or any accident which may be caused by abnormal data written to the PLC due to the influence of noise: <ol style="list-style-type: none"> 1) Do not lay close or bundle with the main circuit line, high-voltage line, or load line. Otherwise, effects of noise or surge induction are likely to take place. Keep a safe distance of least 100 mm (3.94") from the above lines during wiring. 2) Ground the shield wire or shield of a shielded cable at one point on the PLC. However, do not ground at the same point as high voltage lines. • Perform wiring properly to the FX0N/FX2N Series extension equipment of the terminal block type in accordance with the precautions below. Failure to do so may cause electric shock, short-circuit, wire breakage, or damages to the product. <ul style="list-style-type: none"> - The disposal size of the cable end should follow the dimensions described in this manual. - Tightening torque should follow the torque described in this manual. • Observe the following items to wire the lines to the European terminal board. Ignorance of the following items may cause electric shock, short circuit, disconnection, or damage of the product. <ul style="list-style-type: none"> - The disposal size of the cable end should follow the dimensions described in this manual. - Tightening torque should follow the torque described in this manual. - Twist the end of strand wire and make sure there is no loose wires. - Do not solder-plate the electric wire ends. - Do not connect electric wires of unspecified size or beyond the specified number of electric wires. - Fix the electric wires so that the terminal block and connected parts of electric wires are not directly stressed. 	

A	Common Items
B	N:N Network
C	Parallel Link
D	Computer Link
E	Inverter Communication
F	Non-Protocol Communication (RS/RS2 Instruction)
G	Non-Protocol Communication (FX2N-232IF)
H	Programming Communication
I	Remote Maintenance

4.1 Wiring Procedure

1 Confirming the connection method

Confirm the inverter connection method.

→ For details, refer to Section 4.2.

2 Preparing for wiring

Prepare cables, distributors and terminal resistors required in the wiring.

→ For connection cables, refer to Section 4.3.

→ For distributors, refer to Section 4.4.

→ For terminal resistors, refer to Section 4.5.

3 Turning OFF the PLC power

Before starting the wiring work, make sure that the PLC power is OFF.

4 Connecting the power supply (only the FX0N-485ADP)

Connect the power supply to the 24V DC power terminal.

5 Wiring communication equipment

Connect communication equipment with communication port in inverters (PU port, built-in terminal for RS-485, FR-A5NR).

→ For details, refer to Section 4.8.

6 Connecting terminal resistors

Connect terminal resistors to the communication equipment of the PLC and the RDA-RDB signal terminal in the most distant inverter.

→ For details, refer to Section 4.5.

7 Wiring a shielding wire (Class-D grounding)

When using a twisted pair cable, wire a shielding wire.

→ For details, refer to Section 4.6.

4.2 Selecting Cables and Connection Devices

When connecting equipment operating in accordance with RS-485, adopt the following connection method and use 10BASE-T or shielded twisted pair cables.

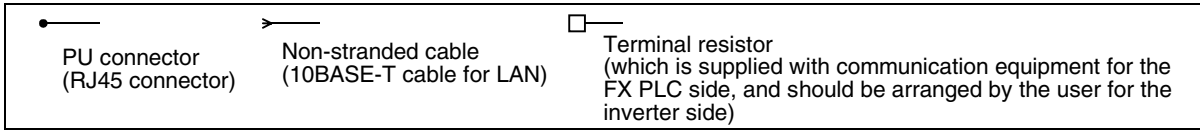

4.2.1 S500, E500, A500, F500 and V500 Series (PU connector)

1. In the case of 1-to-1 connection

When a distributor is not used

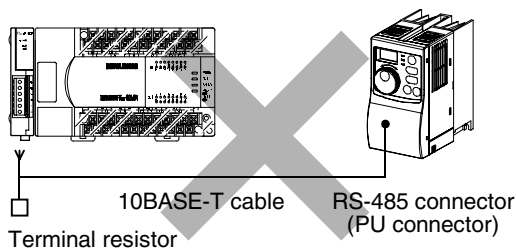

Use a distributor because a terminal resistor cannot be connected to the inverter.

When a distributor is used

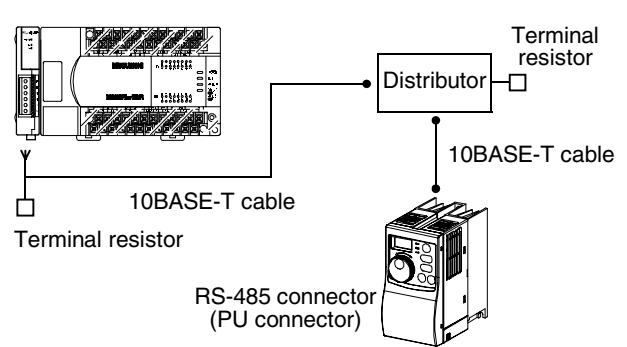

2. In the case of 1-to-N connection

When a distributor is used

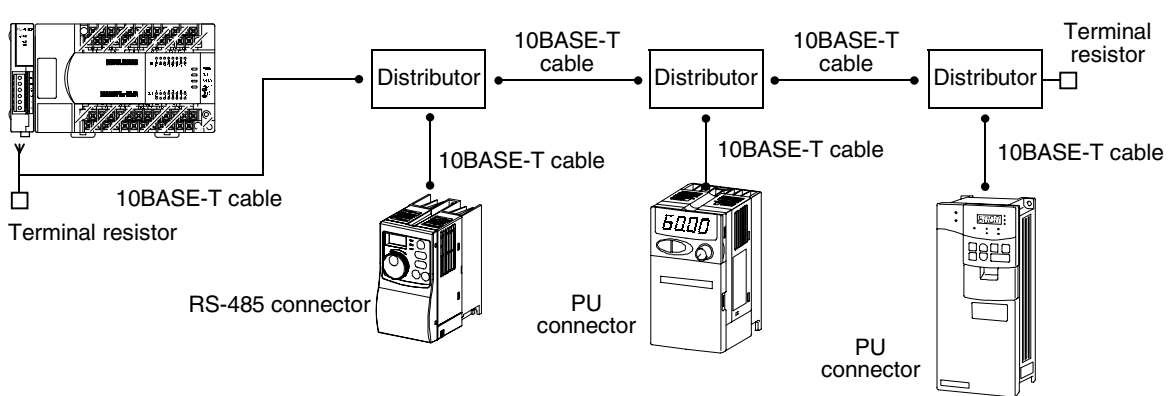

A	Common Items
B	N:N Network
C	Parallel Link
D	Computer Link
E	Inverter Communication
F	Non-Protocol Communication (RS/RS2 Instruction)
G	Non-Protocol Communication (FX2N-232IF)
H	Programming Communication
I	Remote Maintenance

4.2.2 A500, F500 and V500 Series (FR-A5NR)

1. In the case of 1-to-1 connection

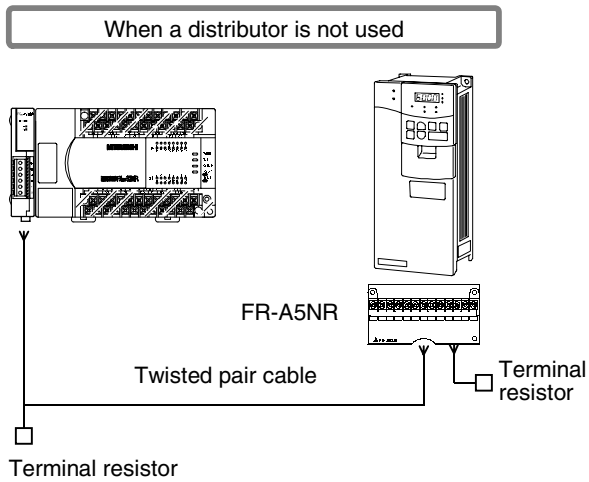

2. In the case of 1-to-N connection

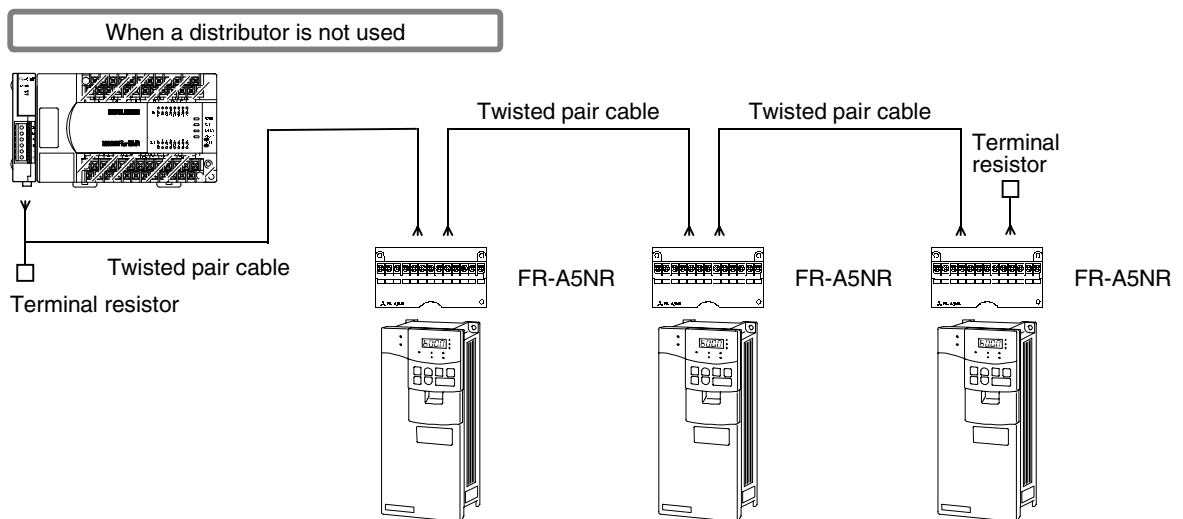

4.2.3 F700 and A700 Series (built-in RS-485 terminal)

1. In the case of 1-to-1 connection

Set the terminal resistor switch in the F700/A700 Series inverter to "100 Ω".

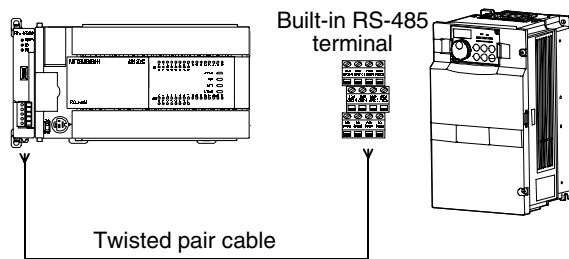

2. In the case of 1-to-N connection

Set the terminal resistor switch in the F700/A700 Series inverter located at the end to "100 Ω".

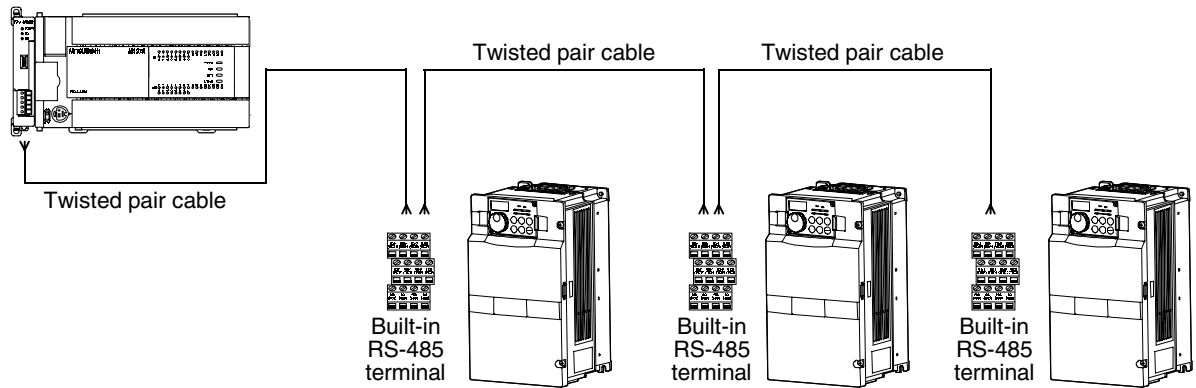

A

Common Items

B

N:N Network

C

Parallel Link

D

Computer Link

E

Inverter Communication

F

Non-Protocol Communication (RS/RS2 Instruction)

G

Non-Protocol Communication (FX2N-232IF)

H

Programming Communication

I

Remote Maintenance

4.3 Connection Cables

4.3.1 Ethernet (10BASE-T) cable

Ethernet cables used in the LAN wiring for a personal computer can be connected.

1. Selection procedure at purchasing

- 1) Cable type : Ethernet cable in accordance with 10BASE-T (Category 3 or 5)
- 2) Connection specifications : Straight type
- 3) Connector : RJ45 connector

2. Cautions on using commercial cables

Pay attention to the following point when purchasing commercial finished cables

- 5V DC is output to the PU connector in the inverters for supplying power to the PU.
 It is necessary to cut the pins Nos. 2 and 8 of commercial cables for omitting wiring to the pins Nos. 2 and 8.

4.3.2 Twisted pair cable (recommended)

The table below shows recommended model names and manufacturers of cables used in wiring.
 Use commercial three-pair type twisted pair cables of 0.3 mm² or more.

1. Recommended cable list

Manufacturer	Model name	Remarks
Sumitomo Electric Industries, Ltd.	DPEV SB 0.3 × 3P	Three-pair cable of 0.3 mm ²
	DPEV SB 0.5 × 3P	Three-pair cable of 0.5 mm ²
The Furukawa Electric Co., Ltd.	D-KPEV-SB 0.5 × 3P	Three-pair cable of 0.5 mm ²

2. Cable structural drawing (reference)

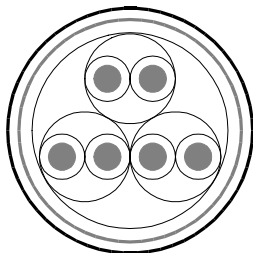

Example of three-pair cable structural drawing

3. Point of contact

For details on cables such as specifications and price, contact each cable manufacturer.

4.3.3 Connecting cables

1. European type terminal block

Use shielded twisted pair cables for connecting communication equipment operating in accordance with RS-485.

The table below shows applicable cables and tightening torque.

	Cable size when one cable is connected	Cable size when two cables are connected	Cable size for bar terminal with insulating sleeve	Tightening torque	Tool size	
					A	B
FX3U-485-BD FX3U-485ADP	AWG22 to AWG20	AWG22	AWG22 to AWG20	0.22 to 0.25 N·m	0.4 (0.01")	2.5 (0.09")
FX2N-485-BD	AWG26 to AWG16		—	0.6 N·m	0.6 (0.03")	3.5 (0.14")
FX2NC-485ADP	AWG26 to AWG16	AWG26 to AWG20	—	0.4 to 0.5 N·m	0.6 (0.03")	3.5 (0.14")

With regard to the cable end treatment, treat a stranded cable or solid cable as it is, or use a bar terminal with insulating sleeve.

- When treating a stranded cable or solid cable as it is
 - Twist the end of a stranded cable so that wires don't get barbed.
 - Do not plate the end of a cable.

FX3U-485-BD, FX3U-485ADP

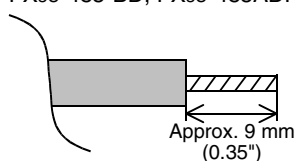

FX1N-485-BD, FX2N-485-BD

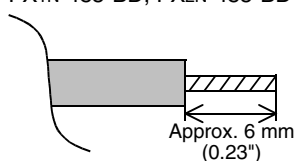

FX2NC-485ADP

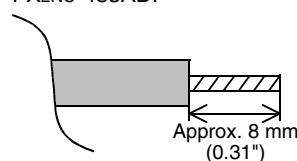

- When using a bar terminal with insulating sleeve

Because it is difficult to insert a cable into an insulating sleeve depending on the cable sheath thickness, select a proper cable according to the outline drawing.

Manufacturer	Model name	Caulking tool
Phoenix Contact	AI 0.5-8WH	CRIMPFOX UD6

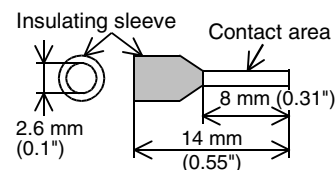

- Tool
 - When tightening a terminal on the European terminal block, use a small commercial screwdriver having straight shape whose tip is not wide as shown in the right figure.

Manufacturer	Model name
Phoenix Contact	SZS 0.4 × 2.5

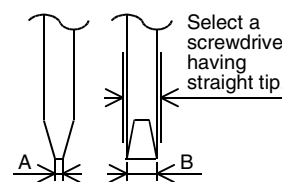

For the size A and size B, refer to the above table.

2. Terminal block

In the FX0N-485ADP, the terminal screw size is "M3".
 Make sure to use a crimp-style terminal having the following sizes.
 Make sure that the tightening torque is 0.5 to 0.8 N·m.

- When wiring one cable to one terminal

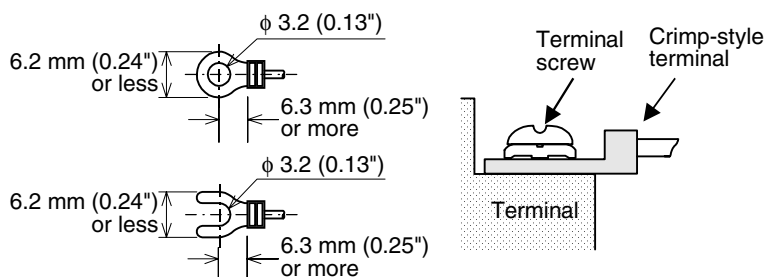

- When wiring two cables to one terminal

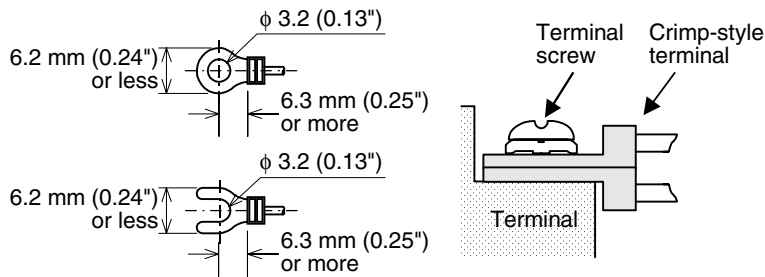

4.4 Connection Devices (RJ45 Connector and Distributor)

Prepare the following devices if necessary.

Product name	Model name	Manufacturer	Check
RJ45 connector	5-554720-3	Tyco Electronics AMP K.K.	
Distributor	BMJ-8 Modular rosette Do not use a plug with terminal resistor supplied together with the above modular rosette.	HACHIKO ELECTRIC CO., LTD	

4.5 Connecting Terminal Resistors

Connect a terminal resistor to the communication equipment of FX PLC and the RDA-RDB signal terminal in the most distant inverter respectively.

→ For details on connection, refer to each wiring diagram.

1. Terminal resistor types

Prepare the following two types of terminal resistors.

Among terminal resistors supplied together with the communication equipment, select one having the color codes shown on the right.

- On the FX PLC side, use a terminal resistor of 110 Ω, 1/2 W supplied together with the communication equipment operating in accordance with RS-485.
- On the inverter side (PU connector except FR-A5NR), prepare a terminal resistor of 100 Ω, 1/2 W by yourself.
- On the inverter side (FR-A5NR), use a terminal resistor chip (supplied together with the FR-A5NR).

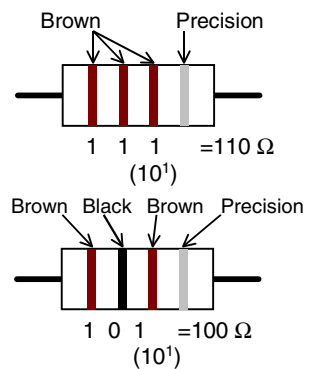

2. Connecting a terminal resistor to the FX PLC

Connect a terminal resistor between the RDA and RDB terminals in the communication equipment.

3. When using the FX3U-485-BD or FX3U-485ADP

The FX3U-485-BD and FX3U-485ADP have a built-in terminal resistor.

Set the terminal resistor selector switch accordingly.

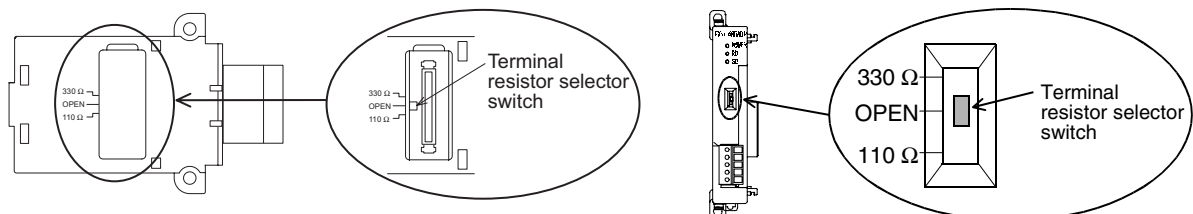

4. Connecting a terminal resistor to the inverter

Communication may be affected by reflection depending on the transmission speed and transmission distance. When communication is hindered by reflection, connect a terminal resistor to the inverter.

- 1) When the PU connector or RS-485 connector (S500 Series) is used in connection
 - Connect a terminal resistor between the pin No. 3 (RDA) and the pin No. 6 (RDB).
 - Connect a distributor to the PU terminal because any terminal resistor cannot be connected.
 - Connect a terminal resistor only to the inverter located in the most distant position from the FX PLC.
- 2) When the FR-A5NR is used in connection
 - Connect a terminal resistor chip (which is supplied together with the FR-A5NR) between the RDB and RDR terminals in the most distant inverter.
- 3) When the built-in RS-485 terminal in the F700 or A700 Series inverter is used in connection
 A terminal resistor is built into the RS-485 terminal. Set the terminal resistor switch in the F700/A700 Series inverter located at the end to "100Ω".

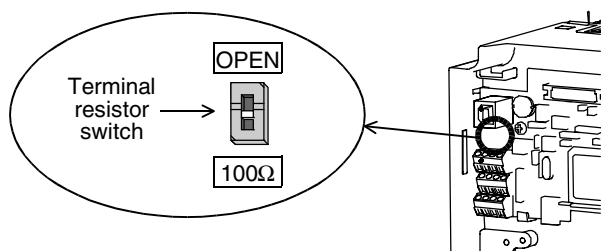

4.6 Wiring a Shielding Wire (Class-D grounding)

Perform Class-D grounding only to one side of a cable according to absence/presence of the grounding terminal.

→ For details on connection, refer to each wiring diagram.

1. When the **FG** terminal is provided in the communication equipment
 Connect the **FG** terminal to the (grounding) terminal in the PLC requiring Class-D grounding.
2. When the **FG** terminal is not provided in the communication equipment
 Perform Class-D grounding directly to the shielding wire of the cable.

4.7 Connector in Inverter

1. In the case of PU port connector

Pin No.	Signal name	Remarks
8	P5S	Not used
7	SG	
6	RDB	
5	SDA	
4	SDB	
3	RDA	
2	P5S	Not used
1	SG	

When seen from inverter front (receptacle side)

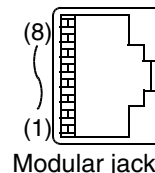

The pins Nos. 2 and 8 (P5S) are provided for the power supply of the operation panel or parameter unit. Do not wire them into inverter communication.

A	Common Items
B	N:N Network
C	Parallel Link
D	Computer Link
E	Inverter Communication
F	Non-Protocol Communication (RS/RS2 Instruction)
G	Non-Protocol Communication (FX2N-232IF)
H	Programming Communication
I	Remote Maintenance

2. In the case of computer link using the FR-A5NR

Attach the FR-5NR to an A500, F500 or V500 Series inverter.

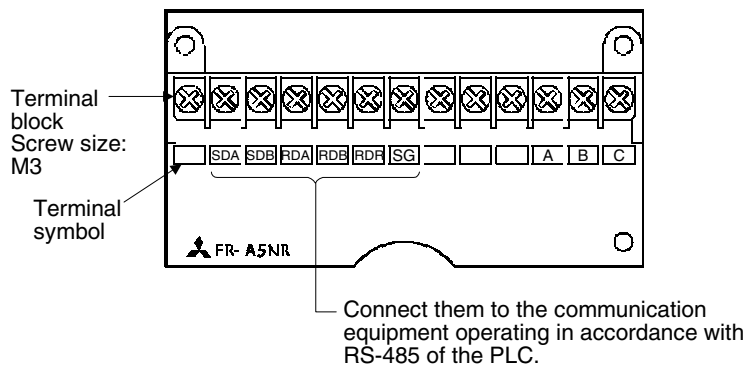

→ For details, refer to the instruction manual of the FR-A5NR.

3. In the case of built-in RS-485 terminal

F700 and A700 Series inverters are equipped with a built-in RS-485 terminal.

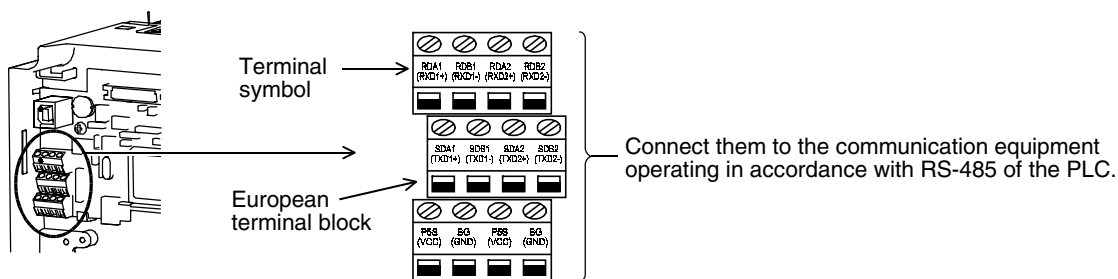

→ For details, refer to the instruction manual of each inverter.

4.8 Connection Diagram

4.8.1 For S500, E500 and A500 Series (PU connector)

1. When one inverter is connected

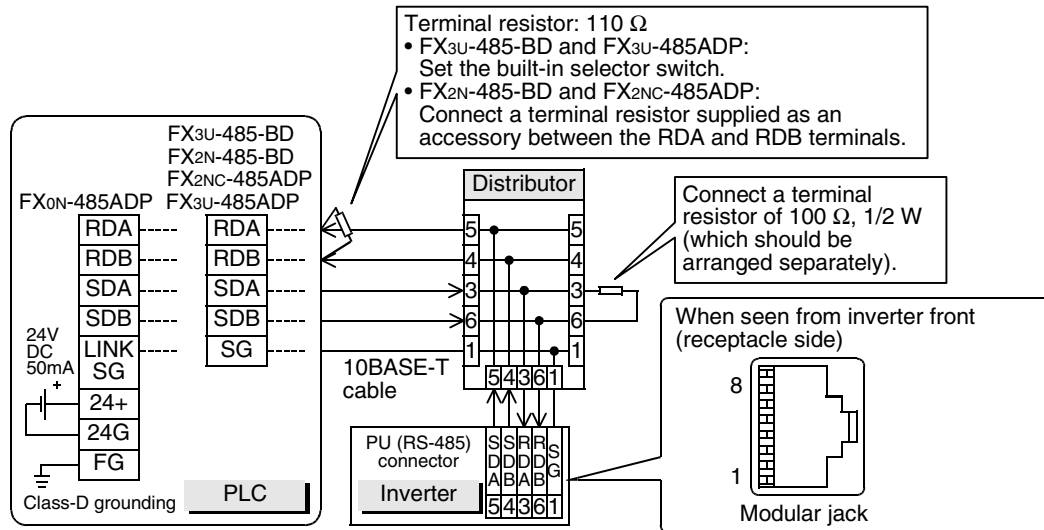

2. When two or more (up to eight) inverters are connected

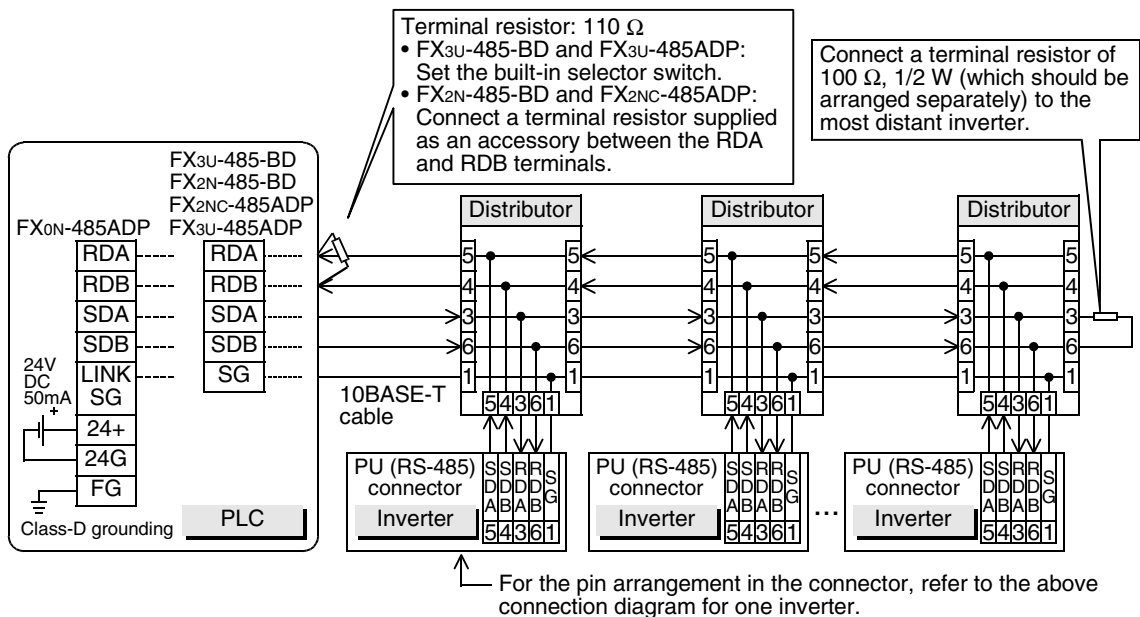

A Common Items
B N:N Network
C Parallel Link
D Computer Link
E Inverter Communication
F Non-Protocol Communication (RS/RS2 Instruction)
G Non-Protocol Communication (FX2N-232IF)
H Programming Communication
I Remote Maintenance

4.8.2 For A500 Series (FR-A5NR)

1. When one inverter is connected

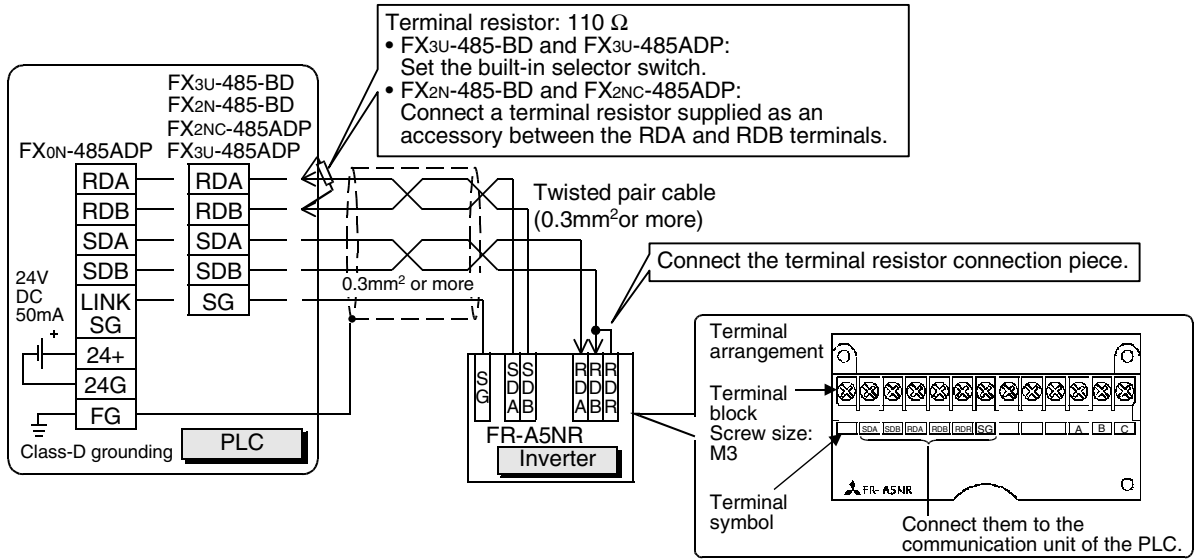

2. When two or more (up to eight) inverters are connected

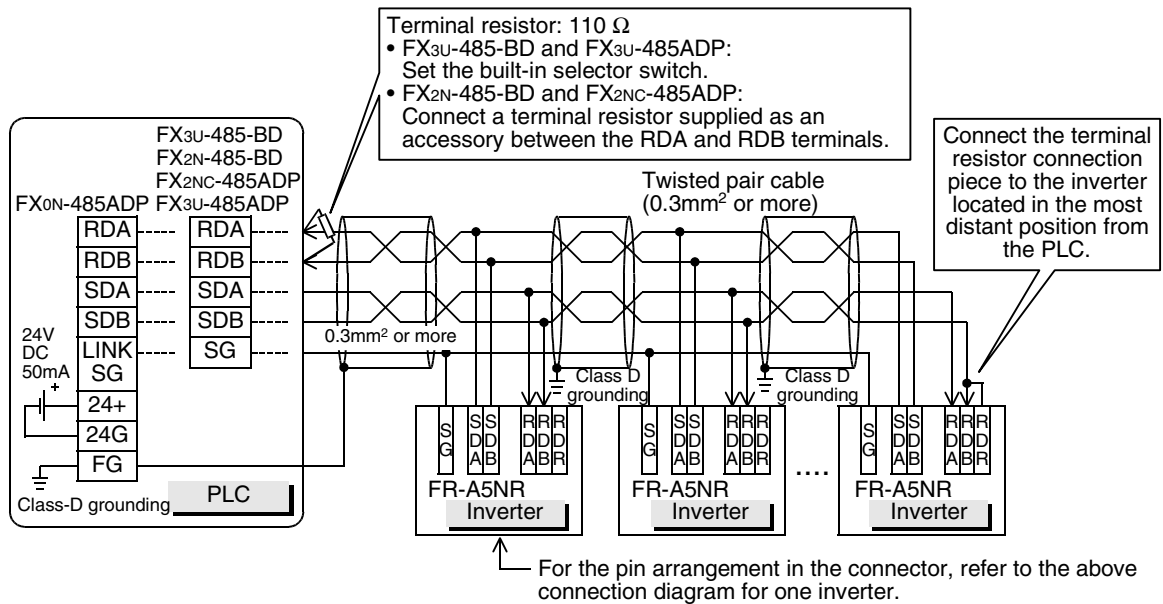

4.8.3 For F700 and A700 Series (built-in RS-485 terminal)

1. When one inverter is connected

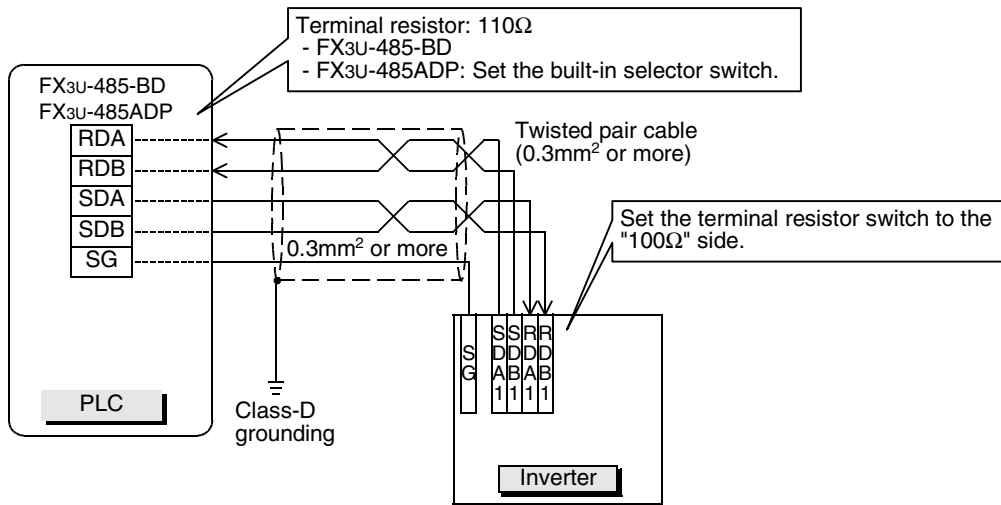

2. When two or more (up to eight) inverters are connected

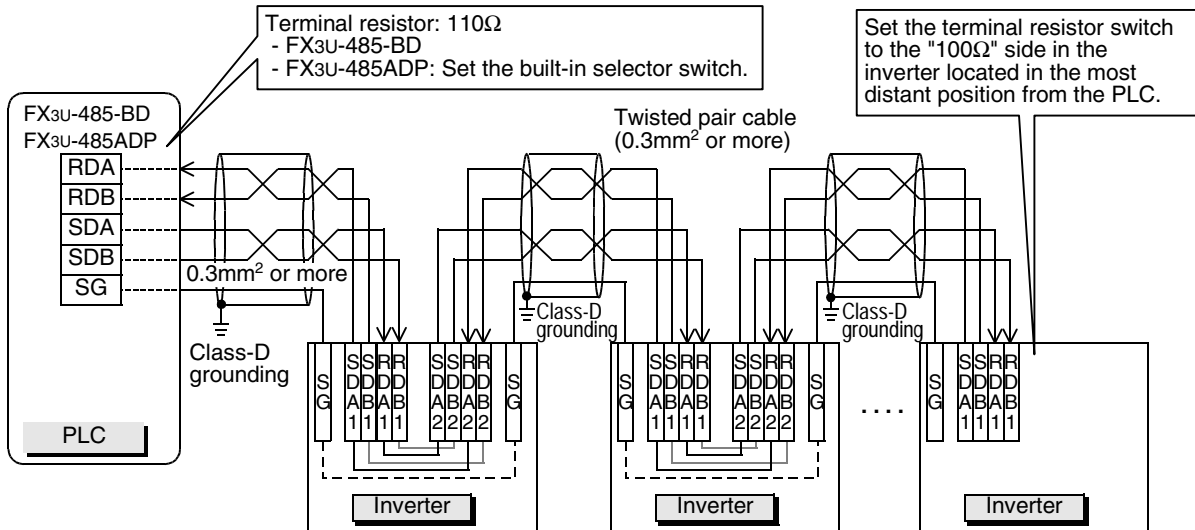

When adopting branches, perform the wiring as shown below:

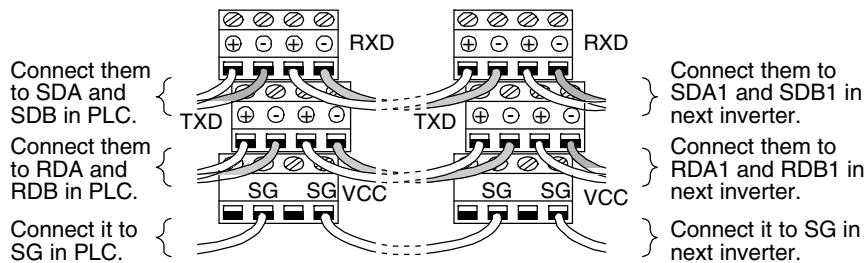

A	Common Items
B	N:N Network
C	Parallel Link
D	Computer Link
E	Inverter Communication
F	Non-Protocol Communication (RS/RS2 Instruction)
G	Non-Protocol Communication (FX2N-232IF)
H	Programming Communication
I	Remote Maintenance

4.9 Grounding

Grounding should be performed as stated below.

- The grounding resistance should be 100Ω or less.
- Independent grounding should be performed for best results.
When independent grounding can not be performed, perform "shared grounding" as shown in the following figure.

→ For details, refer to the Hardware Edition of each series.

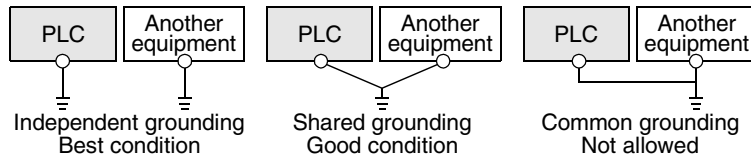

- The grounding wire size should be AWG 14 (2 mm²) or larger.
- The grounding point should be close to the PLC, and all grounding wires should be as short as possible.

5. Communication Setting in Inverter

Before connecting an inverter to a PLC, set parameters related to communication in the parameter unit (PU) of the inverter in advance using the procedure described in this chapter.

If these parameters are overwritten from the PLC after the inverter is connected, communication will be disabled.

If these parameters are changed by mistake, they should be set again.

5.1 Communication Port and Applicable Parameters

When connecting an inverter to a PLC, it is necessary to set parameters corresponding to the communication port in advance.

S500 Series

Remove the surface cover.

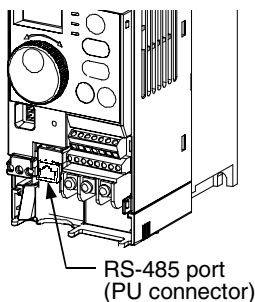

E500 Series

Remove the operation panel.

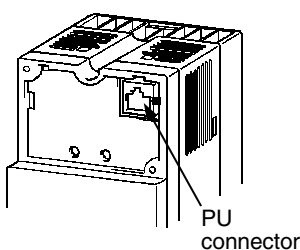

A500, F500 and V500 Series

Remove the operation panel.

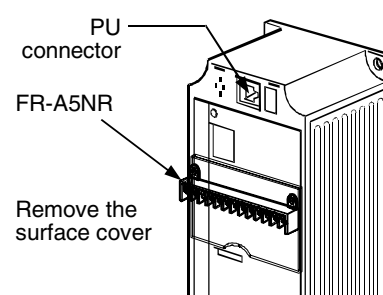

F700 and A700 Series

Remove the surface cover.

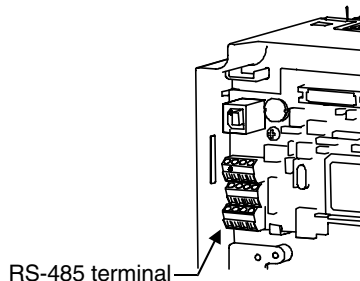

Model	Model classification	Inverter connection destination	Parameters applicable in inverter	Reference section
S500 Series	Only models having built-in RS-485 port	RS-485 port	Pr79,n1 to n12	5.2
E500 Series	Models having built-in PU port	PU port	Pr79,Pr117 to Pr124	5.3
A500 Series	Models having built-in PU port	PU port	Pr79,Pr117 to Pr124	5.4
	Option	FR-A5NR computer link	Pr79,Pr331 to Pr342	5.5
F500 Series	Models having built-in PU port	PU port	Pr79,Pr117 to Pr124	5.4
	Option	FR-A5NR computer link	Pr79,Pr331 to Pr342	5.5
V500 Series	Models having built-in PU port	PU port	Pr79,Pr117 to Pr124	5.4
	Option	FR-A5NR computer link	Pr79,Pr331 to Pr342	5.5
A700 Series	Models having built-in RS-485 terminal	RS-485 terminal	Pr79,Pr331 to Pr342, Pr549	5.6
F700 Series	Models having built-in RS-485 terminal	RS-485 terminal	Pr79,Pr331 to Pr342, Pr549	5.6

5.2 S500 Series (When Connected to RS-485 Port)

5.2.1 Contents of parameter setting

1. Contents of communication setting (essential items)

The table below shows parameters which should be set in any case.

Parameter No.	Parameter item	Set value	Setting contents
n1	Communication station number	00 to 31	Up to eight inverters can be connected.
n2	Communication speed	48	4800 bps
		96	9600 bps (standard)
		192	19200 bps
n3	Stop bit length	10	Data length: 7-bit/Stop bit: 1-bit
n4	Parity check presence/absence	2	Even parity present
n7	Wait time setting	---	Set with communication data
n11	CR/LF selection	1	With CR, without LF
Pr79	Operation mode selection	0	External operation mode is selected when power is turned ON.
n10	Link start mode selection	1	Computer link operation
n6	Communication check time interval	---	Communication check suspension

2. Parameters which should be adjusted between test operation and actual operation

Parameter No.	Parameter item	Set value	Setting contents
n5	Number of communication retries	---	Set the value shown on the left during adjustment, and set a value from 1 to 10 during operation.

3. Others (which should be set if necessary)

The table below shows parameters to be considered when using various system configuration and inverters. For the method of use, refer to the manual of each inverter.

Parameter No.	Parameter item	Set value	Setting contents
n12	EEPROM write selection	0 or 1	0: Written to RAM and EEPROM 1: Written to RAM only. Not written to EEPROM
n8	Operation command write	0 or 1	0: PLC 1: External
n9	Speed command write	0 or 1	0: PLC 1: External

5.2.2 Parameter setting method (reference)

This subsection explains the parameter setting method using the operation panel. For details on the operation panel, refer to the manual of each inverter.

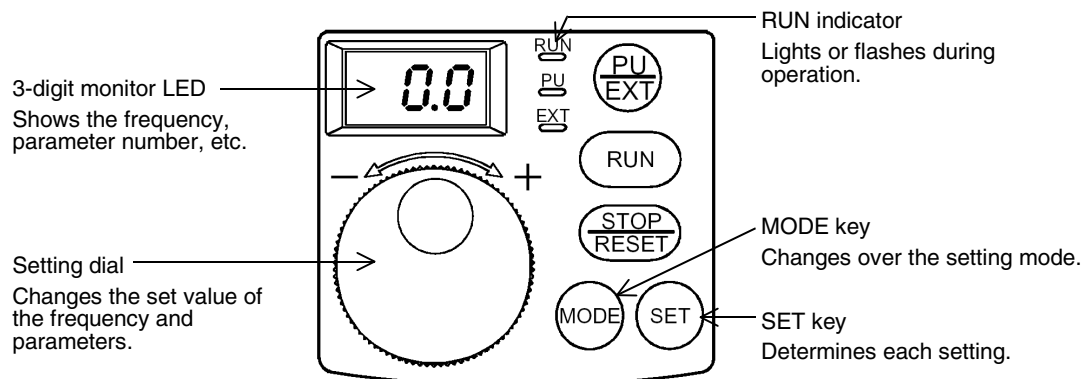

The operating procedure example below shows a case in which the baud rate is set to 19,200 bps.

1 Confirming the RUN indicator and the operation mode

Confirm that the operation is stopped (that the RUN indicator is OFF).

2 Selecting the parameter setting mode

Press the MODE key, and select the parameter setting mode.

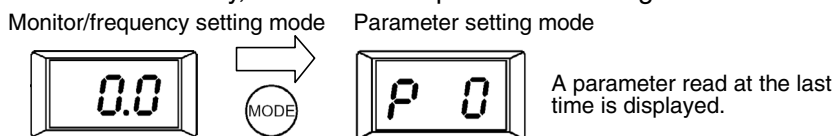

3 Setting the set value of Pr. 30 to "1" (This step is not necessary if Pr. 30 is already set to "1".)

1. Turn the setting dial to display "P30".

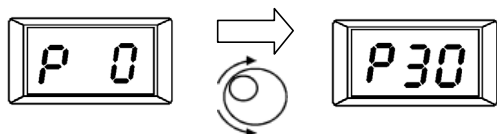

2. Press the SET key to read the currently set value.

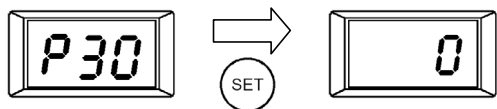

3. Turn the setting dial to change the set value to "1".

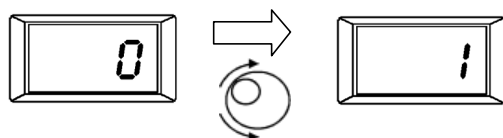

Press the SET key to determine "1".

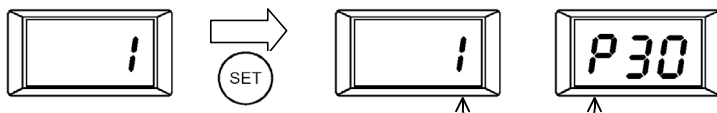

The set value and parameter number are displayed alternately.

When the set value and parameter number are displayed alternately, the setting is completed.

A	Common Items
B	N:N Network
C	Parallel Link
D	Computer Link
E	Inverter Communication
F	Non-Protocol Communication (RS/RS2 Instruction)
G	Non-Protocol Communication (FX2N-232IF)
H	Programming Communication
I	Remote Maintenance

4 Setting the set value of "n2" to "192" ("192" indicates the baud rate of 19200 bps.)

Turn the setting dial to display "n2".

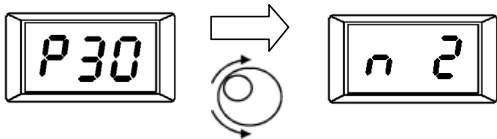

Press the SET key to read the currently set value.

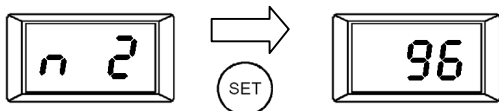

Turn the setting dial to change the set value to "192".

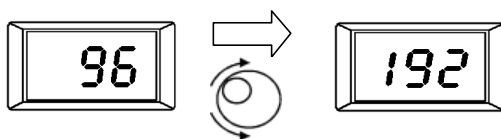

Press the SET key to determine "192".



The set value and parameter number are displayed alternately.

When the set value and parameter number are displayed alternately, the setting is completed.

5 Changing other parameters in the same way as the step 4

→ For details on the parameters to be set, refer to Subsection 5.2.1.

5.3 E500 Series (When Connected to PU Port)

5.3.1 Contents of parameter setting

1. Contents of communication setting (essential items)

The table below shows parameters which should be set in any case.

Parameter No.	Parameter item	Set value	Setting contents
Pr117	Communication station number	00 to 31	Up to eight inverters can be connected.
Pr118	Communication speed	48	4800 bps
		96	9600 bps (standard)
		192	19200 bps
Pr119	Stop bit / Data length	10	Data length: 7-bit/Stop bit: 1-bit
Pr120	Parity check presence/absence	2	Even parity present
Pr123	Waiting time setting	9999	Set with communication data
Pr124	CR·LF presence/absence selection	1	With CR, without LF
Pr79	Operation mode selection	0	External operation mode is selected when power is turned ON.
Pr122	Communication check time interval	9999	Communication check suspension

2. Parameters which should be adjusted between test operation and actual operation

Parameter No.	Parameter item	Set value	Setting contents
Pr121	Number of communication retries	9999	Set the value shown on the left during adjustment, and set a value from 1 to 10 during operation.

3. Others (which should be set if necessary)

The table below shows parameters to be considered when using various system configuration and inverters. For the method of use, refer to the manual of each inverter.

Parameter No.	Parameter item	Set value	Setting contents
Pr146	Frequency setting command selection *1	0, 1, 9999	0 : The built-in frequency setting knob is valid. 1 : The built-in frequency setting knob is invalid. 9999 : The built-in frequency setting knob is valid when the frequency is set to "0 Hz" by the keys.
Pr342	EEPROM write selection (only in 400 V class)	0 or 1	0: EEPROM is written. 1: RAM is written.

*1. When changing the frequency from the PLC, set "1" or "9999".

A	Common Items
B	N:N Network
C	Parallel Link
D	Computer Link
E	Inverter Communication
F	Non-Protocol Communication (RS/RS2 Instruction)
G	Non-Protocol Communication (FX2N-232IF)
H	Programming Communication
I	Remote Maintenance

5.3.2 Parameter setting method (reference)

This subsection explains the parameter setting method using the operation panel. For details on the operation panel, refer to the manual of each inverter.

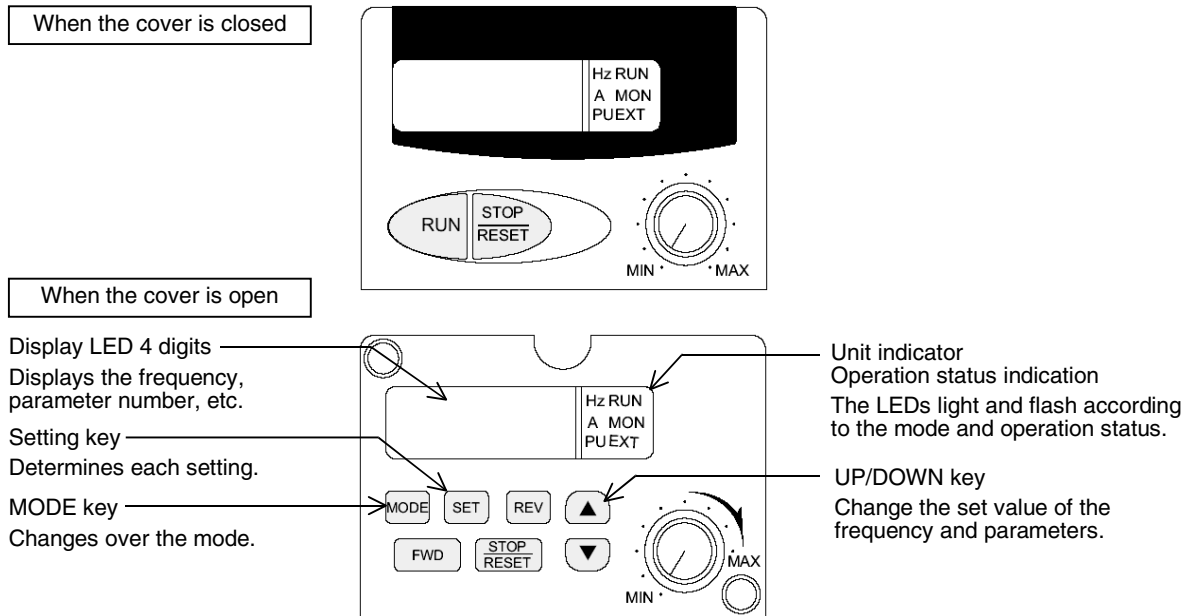

The operating procedure example below shows a case in which the baud rate is set to 19200 bps.

1 Confirming the RUN indicator and the operation mode indicator

Confirm that the operation is stopped (that the RUN indicator is Off).

2 Selecting the parameter setting mode

Press the MODE key, and select the parameter setting mode.

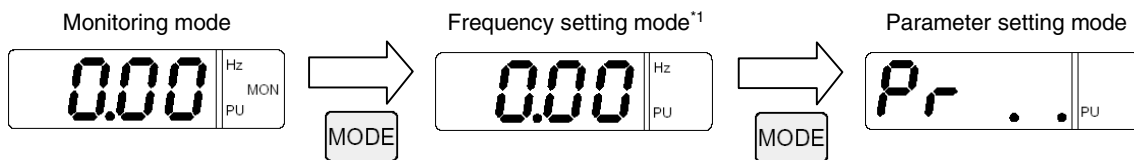

*1. The frequency setting mode is displayed only in the PU operation mode.

3 Reading the parameter (Pr. 118)

There are two methods to read the parameter number:

- Method to read the parameter number using the UP and DOWN keys
 Press the UP and DOWN keys, and display the parameter number to be read.

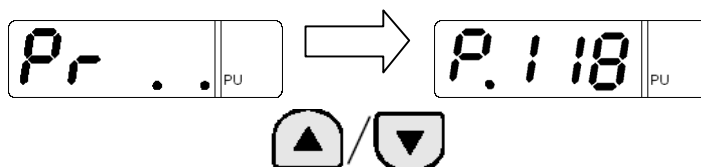

- Method to set each digit of the parameter number
 - a) Press the SET key to flash the most significant digit. Set a numeric value using the UP and DOWN keys.



- b) Press the SET key to flash the middle digit. Set a numeric value using the UP and DOWN keys.

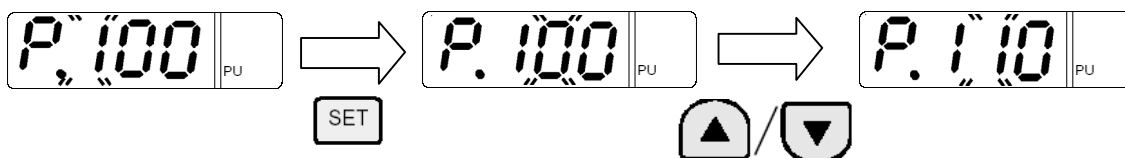

- c) Press the SET key to flash the least significant digit. Set a numeric value using the UP and DOWN keys.

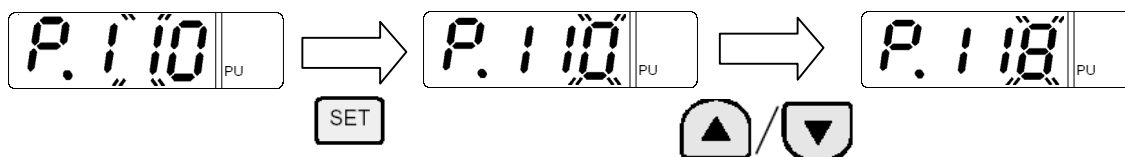

4 Setting the set value of Pr. 118 to "192" ("192" indicates the baud rate of 19200 bps.)

1. Press the SET key to read the currently set value. Change the set value using the UP and DOWN keys.

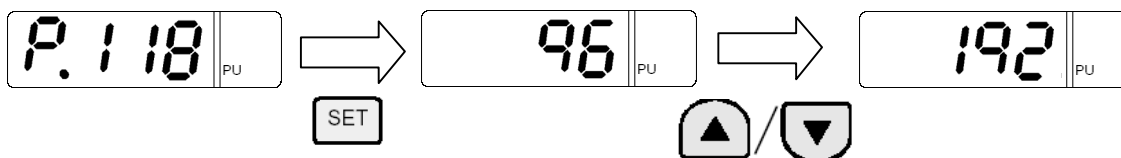

2. Press and hold the SET key for 1.5 seconds to determine "192".

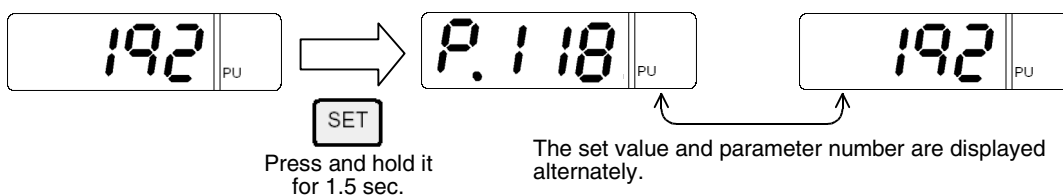

3. Press the SET key to display the next parameter.

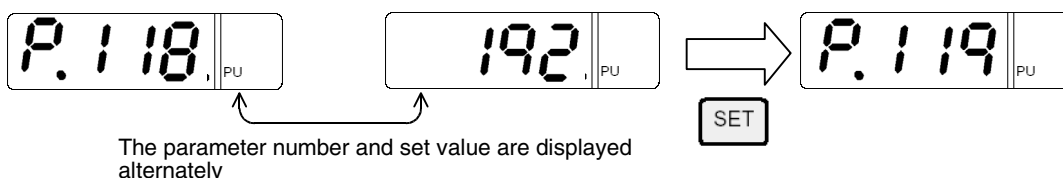

5 Change other parameters in the same way as the step 3.

→ For details on parameters to be set, refer to Subsection 5.3.1.

A	Common Items
B	N:N Network
C	Parallel Link
D	Computer Link
E	Inverter Communication
F	Non-Protocol Communication (RS/RS2 Instruction)
G	Non-Protocol Communication (FX2N-232IF)
H	Programming Communication
I	Remote Maintenance

5.4 V500, F500 and A500 Series (Connection to PU Port)

5.4.1 Contents of parameter setting

1. Contents of communication setting (essential items)

The table below shows parameters which should be set in any case.

Parameter No.	Parameter item	Set value	Setting contents
Pr117	Communication station number	00 to 31	Up to eight inverters can be connected.
Pr118	Communication speed	48	4800 bps
		96	9600 bps (standard)
		192	19200 bps
Pr119	Stop bit length/data length	10	Data length: 7-bit/Stop bit: 1-bit
Pr120	Parity check presence/absence	2	2: Even parity
Pr123	Waiting time setting	9999	Set in communication data
Pr124	CR·LF presence/absence selection	1	CR: Provided, LF: Not provided
Pr79	Operation mode selection	0	External operation mode is selected when power is turned ON.
Pr122	Communication check time interval	9999	Communication check is stopped.

2. Parameters which should be adjusted between test operation and actual operation

Parameter No.	Parameter item	Set value	Setting contents
Pr121	Number of communication retries	9999	Set the value shown on the left during adjustment, and set a value from 1 to 10 during operation.

3. Others (which should be set if necessary)

The table below shows parameters to be considered when using various system configuration and inverters. For the method of use, refer to the manual of each inverter.

Parameter No.	Parameter item	Set value	Setting contents
Pr342	EEPROM write selection	0 or 1	0: EEPROM are written. 1: RAM is written.

5.4.2 Parameter setting method (reference)

This subsection explains the parameter setting method using the operation panel. For details on the operation panel, refer to the manual of each inverter.

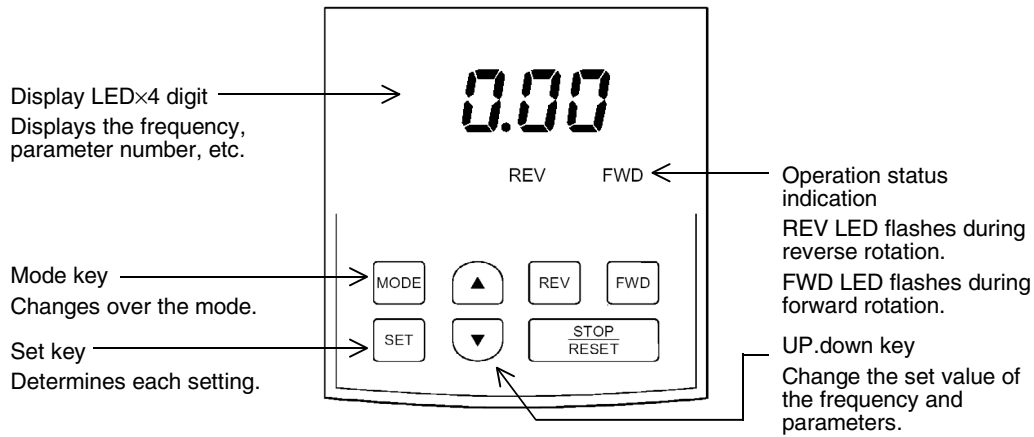

The operating procedure example below shows a case in which the baud rate is set to 19200 bps.

1 Confirming the RUN indicator and the operation mode indicator

Confirm that the operation is stopped (that both the REV and FWD indicators are Off).

2 Selecting the parameter setting mode

Press the MODE key, and select the parameter setting mode.

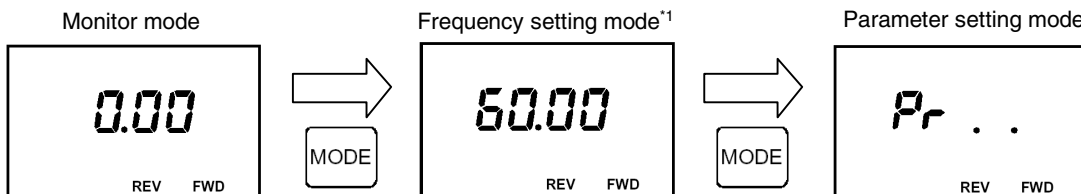

*1. The frequency setting mode is displayed only during the PU operation mode.

3 Reading the parameter (Pr. 118)

There are two methods to read the parameter number:

- Method to read the parameter number using the UP and DOWN keys
 Press the UP and DOWN keys, and display the parameter number to be read.

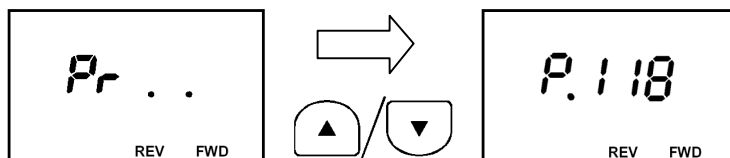

- Method to set each digit of the parameter number
 - Press the SET key to flash the most significant digit. Set a numeric value using the UP and DOWN keys.



A	Common Items
B	N:N Network
C	Parallel Link
D	Computer Link
E	Inverter Communication
F	Non-Protocol Communication (RS/RS2 Instruction)
G	Non-Protocol Communication (FX2N-232IF)
H	Programming Communication
I	Remote Maintenance

b) Press the SET key to flash the middle digit. Set a numeric value using the UP and DOWN keys.



c) Press the SET key to flash the least significant digit. Set a numeric value using the UP and DOWN keys.

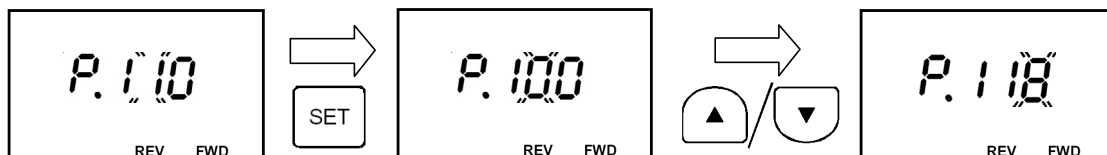

4 Setting the set value of Pr. 118 to "192" ("192" indicates the baud rate of 19200 bps.)

1. Press the SET key to read the currently set value. Change the set value using the UP and DOWN keys.



2. Press and hold the SET key for 1.5 seconds to determine "192".

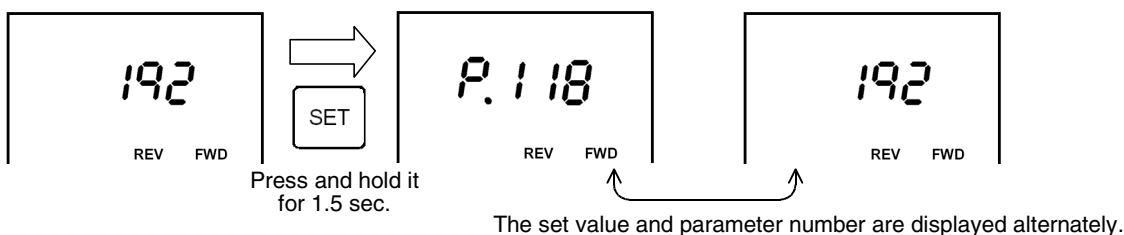

3. Press the SET key to display the next parameter

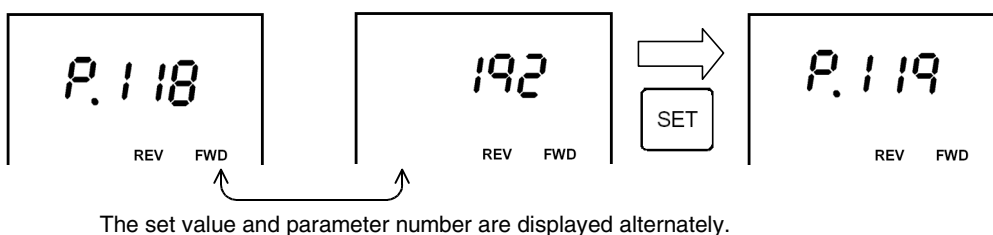

5 Changing other parameters in the same way as the step 3

→ For details on the parameters to be set, refer to Subsection 5.4.1.

5.5 V500, F500 and A500 Series (Connection to FR-A5NR)

5.5.1 Contents of parameter setting

1. Contents of communication setting (essential items)

The table below shows parameters which should be set in any case.

Parameter No.	Parameter item	Set value	Setting contents
Pr331	Communication station number	00 to 31	Up to eight inverters can be connected.
Pr332	Communication speed	48	4800 bps
		96	9600 bps (standard)
		192	19200 bps
Pr333	Stop bit / Data length	10	Data length: 7-bit/Stop bit: 1-bit
Pr334	Parity check presence/absence	2	2: Even parity
Pr337	Waiting time setting	9999	Set in communication data
Pr341	CR, LF presence/absence selection	1	CR: Provided, LF: Not provided
Pr79	Operation mode selection	0	External operation mode is selected when power is turned ON.
Pr340	Link startup mode selection	1	Computer link
Pr336	Communication check time interval	9999	Communication check is stopped.

2. Parameters which should be adjusted between test operation and actual operation

Parameter No.	Parameter item	Set value	Setting contents
Pr335	Number of communication retries	9999	Set the value shown on the left during adjustment, and set a value from 1 to 10 during operation.

3. Others (which should be set if necessary)

The table below shows parameters to be considered when using various system configuration and inverters. For the method of use, refer to the manual of each inverter.

Parameter No.	Parameter item	Set value	Setting contents
Pr342	EEPROM write selection	0 or 1	0: EEPROM are written. 1: RAM is written.
Pr338	Operation command right	0 or 1	0: PLC 1: Outside
Pr339	Speed command write	0 or 1	0: PLC 1: Outside

5.5.2 Parameter setting method (reference)

The parameter setting method is same as that for the V500, F500 and A500 Series (connection to the PU port).

→ For the parameter setting method, refer to Subsection 5.4.2.

5.6 F700 and A700 Series (when built-in RS-485 terminal is connected)

5.6.1 Contents of parameter setting

1. Contents of communication setting (essential items)

The table below shows parameters which should be set in any case.

Parameter No.	Parameter item	Set value	Setting contents
Pr331	RS-485 communication station	00 to 31	Up to eight inverters can be connected.
Pr332	RS-485 communication speed*1	48	4800 bps
		96	9600 bps (standard)
		192	19200 bps
Pr333	RS-485 communication stop bit length	10	Data length: 7-bit/Stop bit: 1-bit
Pr334	RS-485 communication parity check selection	2	2: Even parity
Pr337	RS-485 communication waiting time setting	9999	Set in communication data
Pr341	RS-485 communication CR/LF selection	1	CR: Provided, LF: Not provided
Pr79	Operation mode selection	0	External operation mode is selected when power is turned ON.
Pr340	Communication startup mode selection	1	Computer link
Pr336	RS-485 communication check time interval	9999	Communication check is stopped.
Pr549	Protocol selection	0	Mitsubishi inverter (computer link) protocol

*1. The RS-485 communication speed set value "38400 bps" is not supported by FX PLCs.

2. Parameters which should be adjusted between test operation and actual operation

Parameter No.	Parameter item	Set value	Setting contents
Pr335	RS-485 communication number of retries	9999	Set the value shown on the left during adjustment, and set a value from 1 to 10 during operation.

3. Others (which should be set if necessary)

The table below shows parameters to be considered when using various system configuration and inverters. For the method of use, refer to the manual of each inverter.

Parameter No.	Parameter item	Set value	Setting contents
Pr342	Communication EEPROM write selection	0 or 1	0: EEPROM is written. 1: RAM is written.
Pr338	Communication operation command source	0 or 1	0: PLC 1: Outside
Pr339	Communication operation command source	0 or 1	0: PLC 1: Outside

5.6.2 Parameter setting method (reference)

This subsection explains the parameter setting method using the operation panel.
 For details on the operation panel, refer to the manual of each inverter.

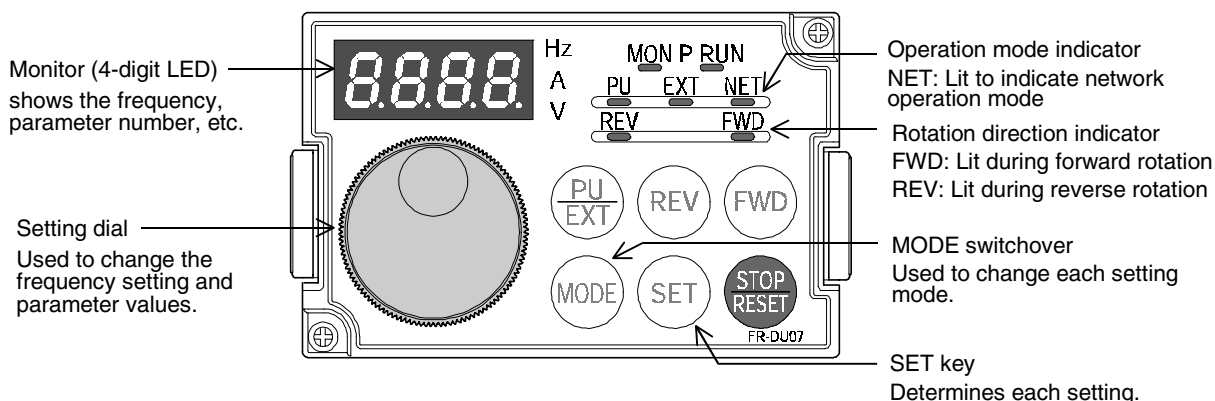

The operating procedure example below shows a case in which the baud rate is set to 19200 bps.

1 Confirming the RUN indicator and the operation mode indicator

Confirm that the operation is stopped (that the RUN indicator is off).

2 Selecting the parameter setting mode

Press the MODE key, and select the parameter setting mode.

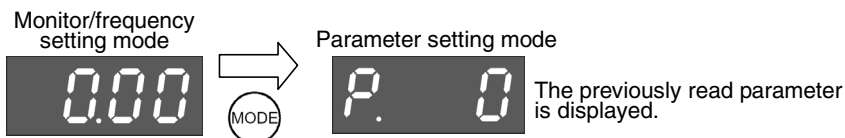

3 Setting the parameter Pr. 160 to "0" (This step is not required if Pr. 160 is already set to "0".)

1. Turn the setting dial until "Pr. 160" is displayed.

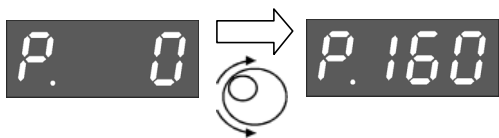

2. Press the SET key to read the current set value.

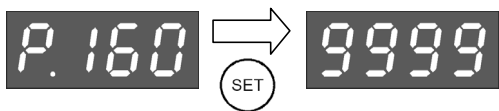

3. Turn the setting dial, and change the set value to "0".

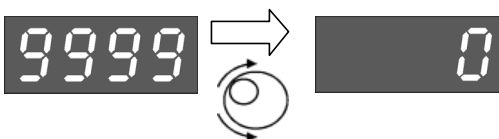

A
Common Items

B
N:N Network

C
Parallel Link

D
Computer Link

E
Inverter Communication

F
Non-Protocol Communication (RS/RS2 Instruction)

G
Non-Protocol Communication (FX2N-232IF)

H
Programming Communication

I
Remote Maintenance

Press the SET key to determine the set value.



The set value and parameter number are displayed alternately.

The set value and parameter number are displayed alternately, and the setting is completed.

4 Setting the parameter Pr. 332 to "192" ("192" indicates the baud rate of 19200 bps.)

Turn the setting dial until "Pr. 332" is displayed.

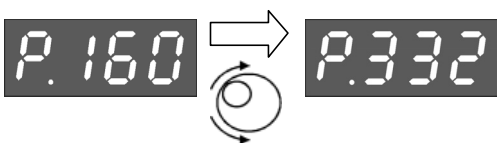

Press the SET key to read the current set value.

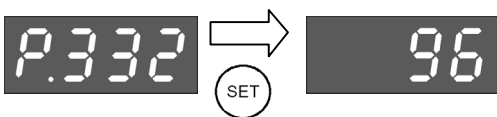

Turn the setting dial, and change the set value to "192".

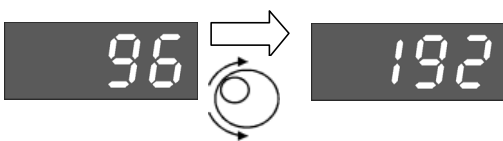

Press the SET key to determine the set value.



The set value and parameter number are displayed alternately.

The set value and parameter number are displayed alternately, and the setting is completed.

5 Changing other parameters in the same way as the step 4

→ For details on the parameters to be set, refer to Subsection 5.6.1.

5.7 Cautions on Setting

1. Setting of the "communication check time interval"

Description	Set value
During adjustment or when communication with the PLC is not executed periodically	Value shown in table
When communication with the PLC is not executed	0
Set the communication time in the following cases: When it is necessary to monitor absence of communication for a certain time and stop the inverter in such a case while communication with the PLC is always executed When it is necessary to stop the motor at the timing at which the PLC mode is changed from RUN to STOP	0.1 to 999.8 sec

6. Communication Setting in FX Programmable Controller

This chapter explains the communication setting method for inverter communication.
 Set non-protocol communication for inverter communication.

6.1 Parameter Assigning Method

Use parameters for communication setting in the FX PLC.

1. Parameter assigning method

Register the communication setting in the sequence programming software parameters, and transfer the parameters to the PLC.

2. Setting flow

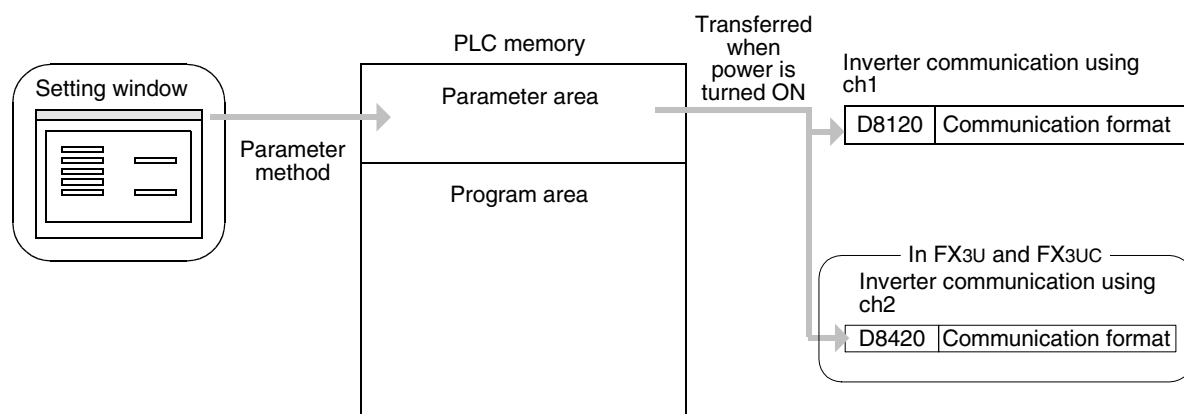

A

Common Items

B

N:N Network

C

Parallel Link

D

Computer Link

E

Inverter Communication

F

Non-Protocol Communication (RS/RS2 Instruction)

G

Non-Protocol Communication (FX2N-232IF)

H

Programming Communication

I

Remote Maintenance

6.2 Communication Setting in Parameter Method (GX Developer)

Two software packages, GX Developer and FXGP/WIN for Windows, are applicable to the parameter method. This section explains the parameters using GX Developer.

Applicable models: FX2N, FX2NC, FX3U, and FX3UC Series

6.2.1 Operating procedure

This subsection explains the serial communication setting method. Suppose that GX Developer is already started up.

1 Opening the parameter setting window

Double-click [Parameter]-[PLC parameter] from the project tree.

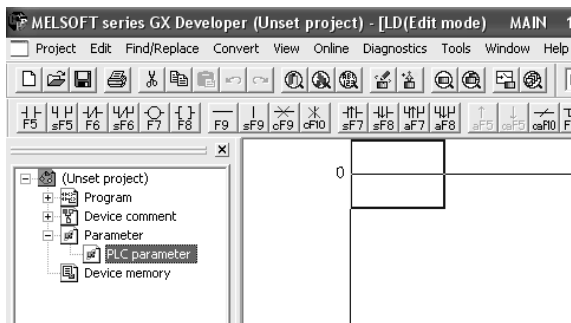

If the project tree is not displayed, select [View] - [Project data list] from the tool menu.

2 Setting the serial communication (parameters)

Click the [PLC system(2)] tab in the "FX parameter window".

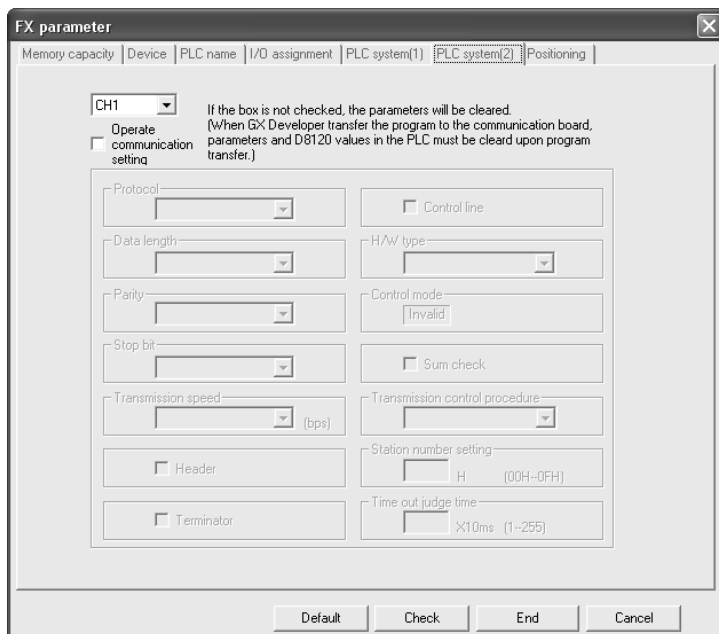

3 Setting the serial communication (parameters)

Set the parameters as shown below:

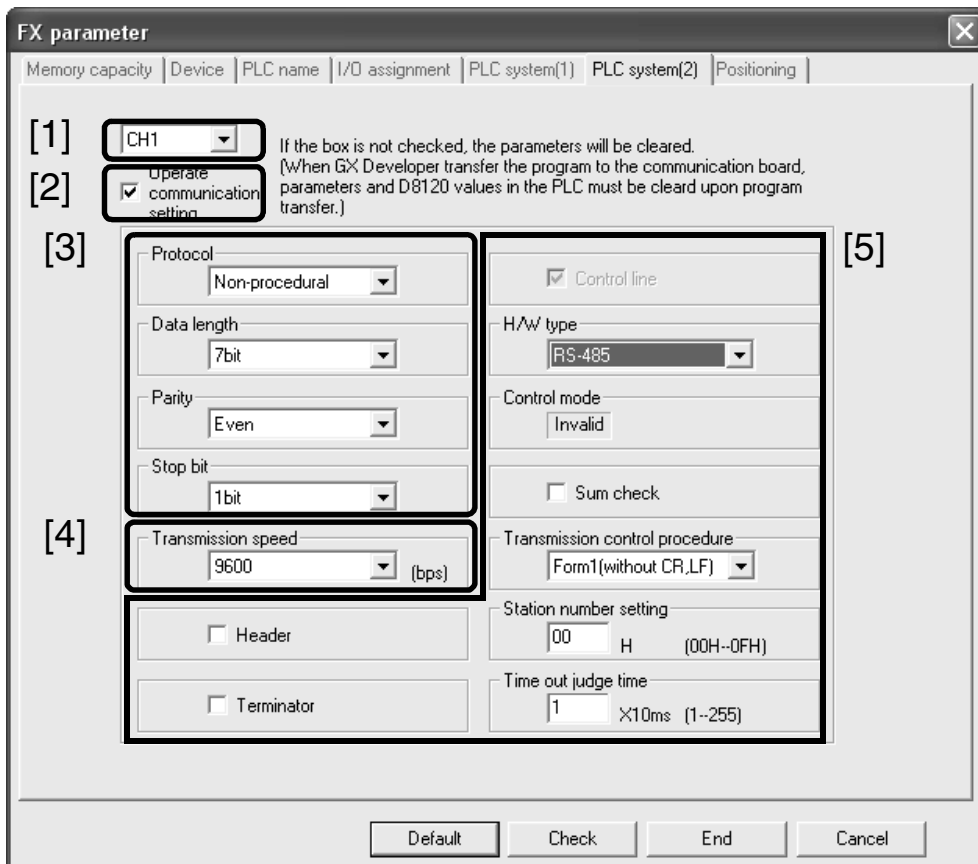

- [1] Set the channel to be used. (This parameter can be set only in the FX3U and FX3UC PLCs.)
- [2] Put a check mark in the "Operate communication setting" check box.
- [3] Set "Protocol" in "Non-procedural," "Data length" to "7bit," "Parity" to "Even," and "Stop bit" to "1bit."
- [4] Set "Transmission speed" to either "4800," "9600" or "19200," and make sure that the set value here is the same as the set value in the inverters.
- [5] Ignore these items.

4 Writing parameters and program to the PLC

Select [Online] - [Write to PLC] from the tool menu, put a check mark (✓) next to "Parameter" and "Program," and then click [Execute].

A	Common Items
B	N:N Network
C	Parallel Link
D	Computer Link
E	Inverter Communication
F	Non-Protocol Communication (RS/RS2 Instruction)
G	Non-Protocol Communication (FX2N-232IF)
H	Programming Communication
I	Remote Maintenance

6.3 Communication Setting in Parameter Method (FXGP/WIN)

Two software packages, GX Developer and FXGP/WIN for Windows, are applicable to the parameter method. This section explains the parameters using FXGP/WIN.

Applicable models: FX2N and FX2NC Series

6.3.1 Operating procedure

This subsection explains the serial communication setting method. Suppose that FXGP/WIN is already started up.

1 Displaying the serial communication (parameter) setting

Select [Option] - [Serial setting (parameter)] from the tool menu.
The following dialog box appears according to absence/presence of parameter setting.

1. When there are no parameter settings

There is no communication setting. Click the [Yes] button.

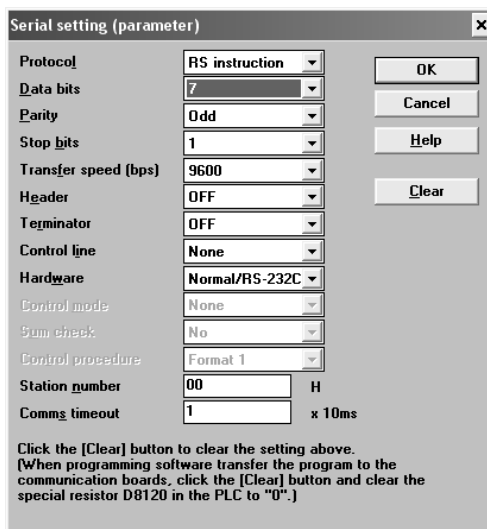
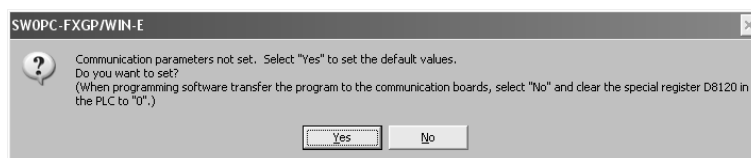

2. When there are already parameter settings

The existing communication setting contents are displayed.

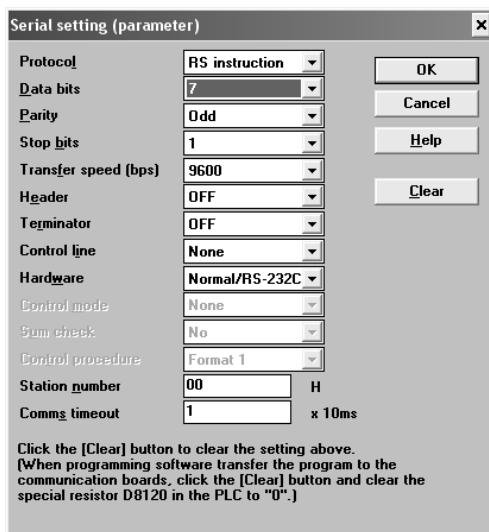

2 Executing serial communication (parameter) setting

Execute the communication setting as shown below.

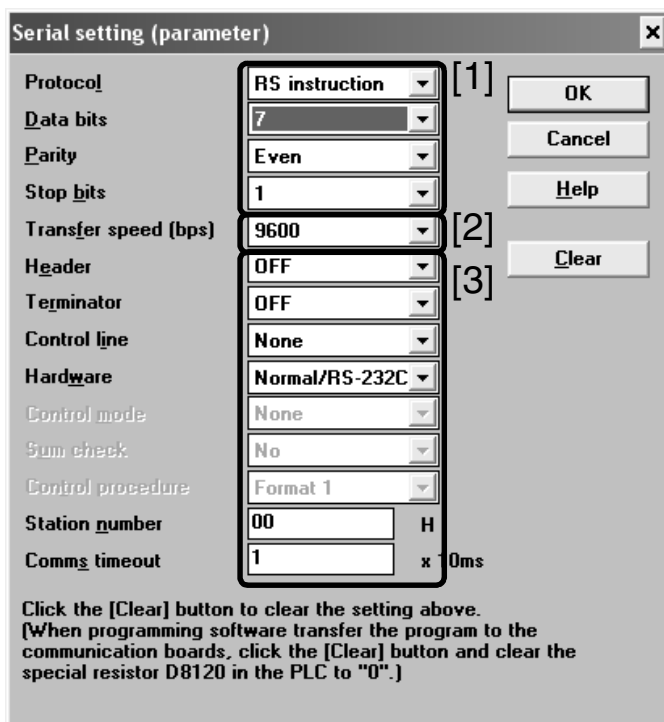

[1] Set "Protocol" to "RS instruction," "Data bits" to "7," "Parity" to "Even," and "Stop bits" to "1".

[2] Set "Transfer speed [bps]" to either "4800," "9600" or "19200," and make sure that the set value here is the same as the set value in the inverters.

[3] Ignore these items.

3 Writing a sequence program (parameters) to the PLC

Select [PLC] - [Transfers] - [Write] from the tool menu, and click [OK].

7. Creating Programs (for FX2N and FX2NC PLCs)

This chapter explains how to create programs which change parameters of inverters and give operation commands to inverters.

As explanation, a program example is shown for each applied instruction.

7.1 Checking Contents of Related Devices

The tables below show devices used in inverter communication in FX2N and FX2NC PLCs.

1. Bit devices

Device No.	Name	Description	R/W
M8029	Instruction execution complete	Turns ON when execution of EXTR instruction is completed, and remains ON for 1 scan. Turns ON also when execution of instruction is completed if M8156 (communication error or parameter error) turns ON.	R
M8104	Extension ROM cassette check	Remains ON while an extension ROM cassette is attached.	R
M8154	Unused	—	R
M8155	Communication port busy	Remains ON while the communication port is used by AN extr instruction.	R
M8156	Communication error or parameter error	Turns ON when a communication error is caused by AN extr instruction.	R
M8157	Communication error latch*1	Turns ON when a communication error occurs.	R

R: For reading only (used as a contact in program)

*1. Cleared when the PLC mode is changed from STOP to RUN.

2. Word devices

Device No.	Name	Description	R/W
D8104	Extension ROM cassette type code	Stores the type code of an extension ROM cassette (value: K1).	R
D8105	Extension ROM cassette version	Stores the version of an extension ROM cassette (value: K100 = Ver. 1.00).	R
D8154	Inverter response waiting time	Sets the inverter response waiting time.	R/W
D8155	Step number of instruction using communication port	Stores the step number of EXTR instruction using the communication port.	R
D8156	Error code*1	Stores an error code when a communication error is caused by an EXTR instruction.	R
D8157	Error occurrence step number latch*1	Stores the instruction step number in which a communication error has occurred. (Stores K-1 when no error has occurred.)	R

R: For reading only

W: For writing only

*1. Cleared when the PLC mode is changed from STOP to RUN.

7.2 Common Items in Inverter Communication Instructions

7.2.1 Inverter communication types (EXTR K10 to K13)

An FX2N/FX2NC PLC and inverter execute communication using EXTR (FNC180) instruction. EXTR instruction can be described in four types of methods, from "EXTR K10" to "EXTR K13", depending on the data communication direction and parameter writing/reading direction.

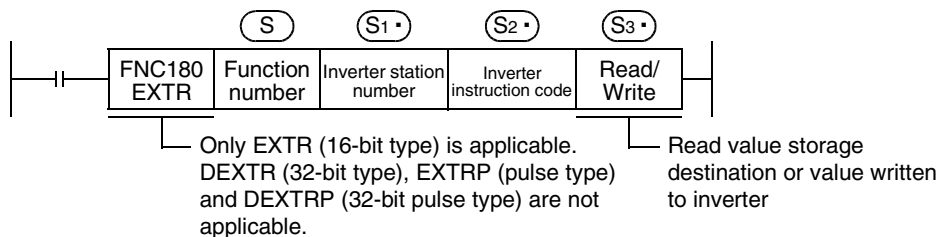

Instruction	Function number (S)	Function	Control direction	Detailed explanation
EXTR(FNC180)	K10	Monitors operations of an inverter	PLC ← inverter	7.3
	K11	Controls operations of an inverter	PLC → inverter	7.4
	K12	Reads a parameter in an inverter	PLC ← inverter	7.5
	K13	Writes a parameter in an inverter	PLC → inverter	7.6

7.2.2 Function and operation

1. Communication start timing

At the rising edge (OFF→ON) of the drive condition, the PLC starts communication with an inverter. Even if the drive condition turns OFF during communication with an inverter, the PLC executes communication until the end. When the drive condition is always ON, the PLC executes communication repeatedly.

2. Simultaneous driving of EXTR instructions and communication processing

- 1) Driving instructions at the same time
 - Two or more EXTR functions (K10 to K13) can be programmed, and driven at the same time.
 - When two or more instructions are driven at the same time during communication, the next EXTR instruction in the program is executed after the current communication with an inverter is finished.

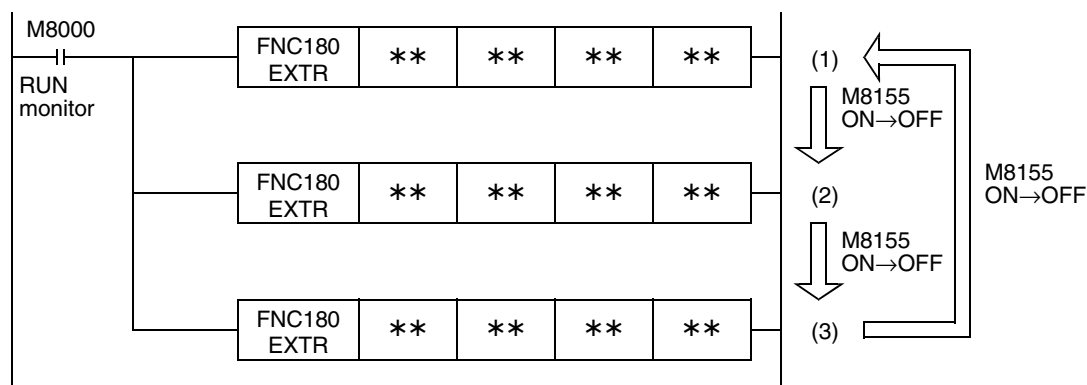

- Even if the drive condition turns ON, the PLC does not start execution of EXTR instruction until the communication port busy flag M8155 turns OFF from ON if M8155 was set to ON by another EXTR instruction.
 The PLC waits for 15 ms after freeing the communication port, and then executes EXTR instructions driven in the next step and so on.

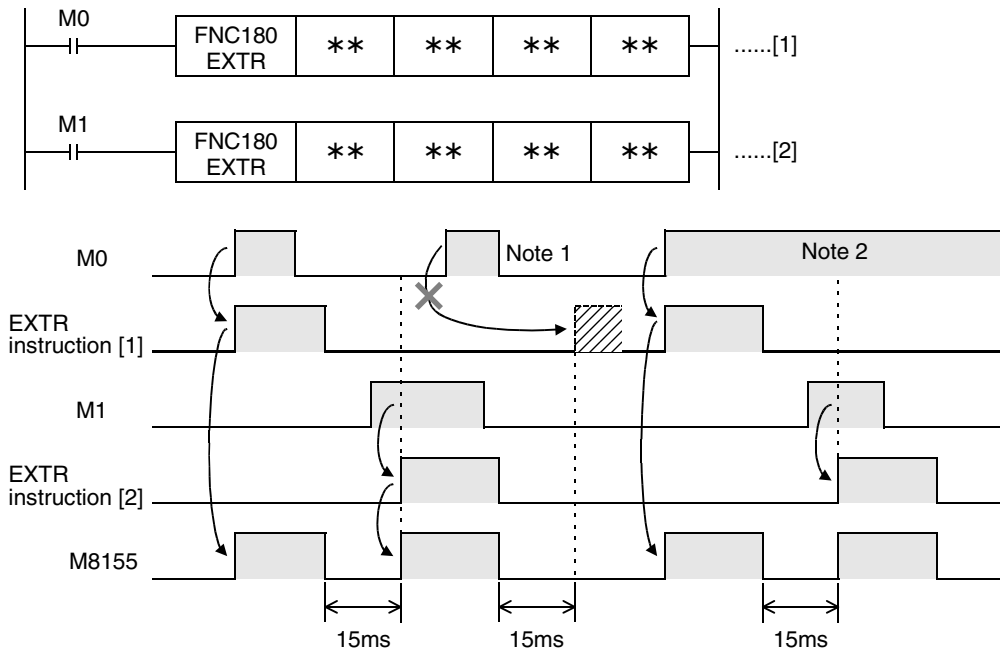

Note 1: If the drive contact is OFF in 15 ms after M8155 turned OFF from ON, the instruction cannot be executed.
 Note 2: When two or more instructions are driven at the same time during communication, the EXTR instruction in the next step is executed after the current communication with an inverter is finished.

2) Cautions on programming

When the drive contact for another EXTR instruction is driven by a pulse signal during communication with an inverter, the communication is not executed.
 When communicating with inverters for two or more items, let the drive contact for EXTR instruction remain ON until sending is completed. After communication with all inverters is finished, set the drive contact to OFF using the instruction execution complete flag M8029.

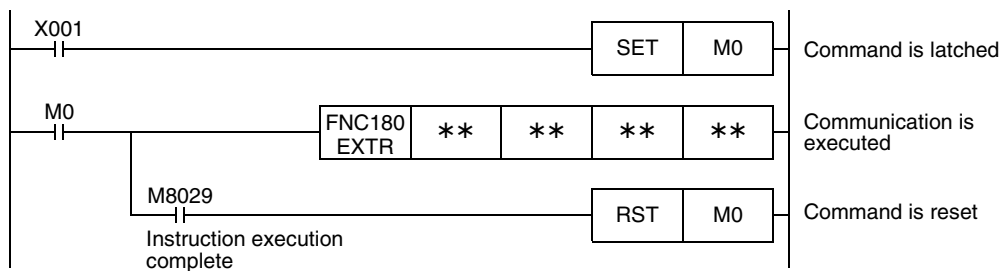

3. Communication complete flag (M8029)

When communication with an inverter is finished, the instruction execution complete flag M8029 turns ON, and remains ON for 1 scan.
 For details on using M8029 method, refer to program examples shown below.

7.2.3 Instruction completion and error flag operation

When two or more EXTR instructions are programmed, the following flags turn ON or OFF according to the execution result of each EXTR instruction.

For acquiring the result of each EXTR instruction, make sure to provide these flags just below each EXTR instruction.

Device number	Description
M8029	Instruction execution complete
M8156	Communication error or parameter error
D8156	Error code

1. Operation of M8029 (instruction execution complete flag)

M8029 (instruction execution complete flag) operates as shown below.

In the program below, M0 and M2 turn OFF and M1 turn ON when communication is completed.

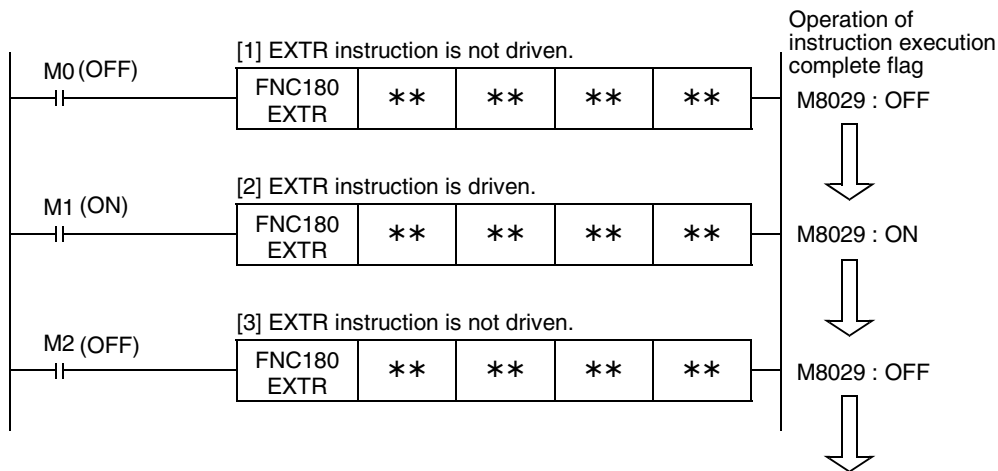

2. Operations of M8156 (error flag) and D8156 (error code)

M8156 (error flag) and D8156 (error code) operate as shown below.

In the program below, a communication error occurs in [1] and [3], and communication is completed normally in [2].

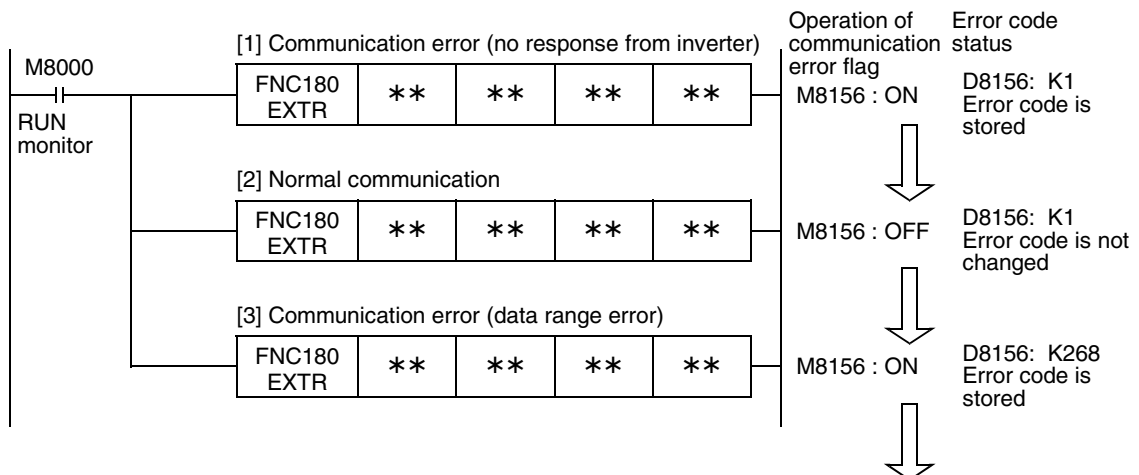

A	Common Items
B	N:N Network
C	Parallel Link
D	Computer Link
E	Inverter Communication
F	Non-Protocol Communication (RS/RS2 Instruction)
G	Non-Protocol Communication (FX2N-232IF)
H	Programming Communication
I	Remote Maintenance

3. Program examples

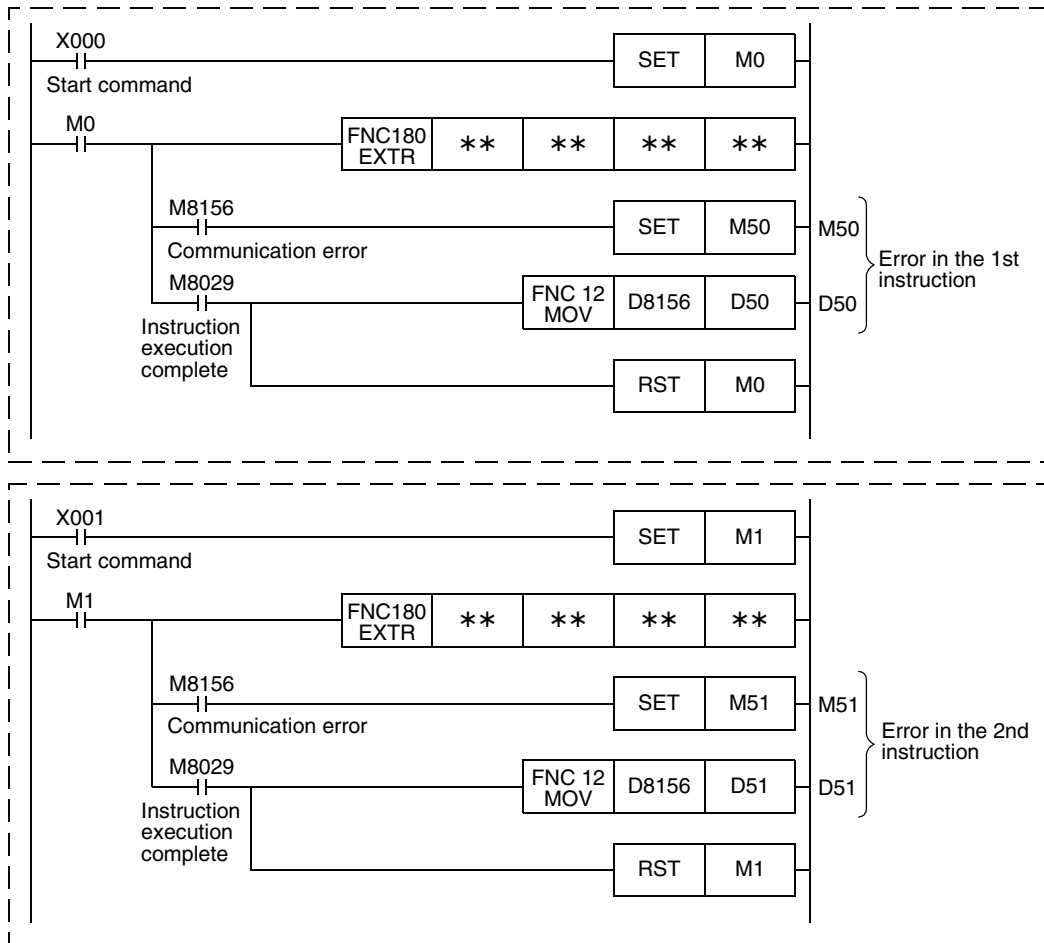

7.2.4 Cautions on programming

1. Using EXTR instruction together with another instruction

- EXTR instruction cannot be used together with RS instruction.
- EXTR instruction cannot be used together with EXTR K0 instruction.

2. When programming EXTR instruction in a state of STL instruction

Make sure to let the state relay remain ON until communication with an inverter is completed. If the state relay is set to OFF during communication, EXTR instruction is stopped in the middle of execution, and another EXTR instruction cannot be started. Program a sequence while observing the following cautions

- Add M8029 (instruction execution complete flag) ON condition to the state relay transfer condition, and provide such an interlock that the state relay ON/OFF status does not change during communication with an inverter.
 If the state relay is set to OFF during communication, the remaining communication can be completed by setting the state relay to ON again.
- When resetting many state relays at one time using ZRST (FNC 40) instruction, etc., make sure that the M8155 (communication port busy) OFF condition is established.

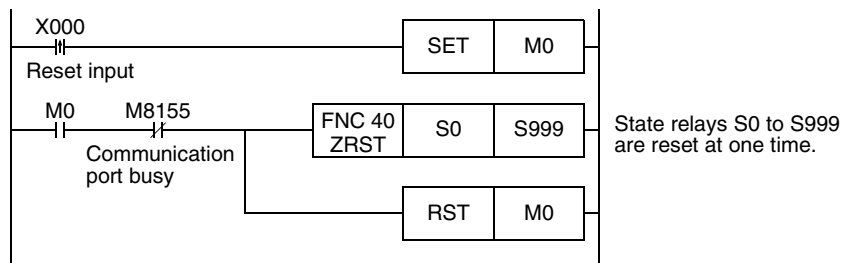

3. Using EXTR instruction in a program flow

EXTR instruction cannot be used in the following program flows

Program flow disabling EXTR instruction	Remarks
Between CJ and P instructions	Conditional jump
Between FOR and NEXT instructions	Repeat
Between P and SRET instructions	Subroutine
Between I and IRET instructions	Interrupt routine

4. Caution on write during RUN

- Condition in which EXTR instruction can be written
 While the PLC is in the STOP status, EXTR instruction can be written during RUN.
- Condition in which EXTR instruction cannot be written
 EXTR instruction cannot be written in RUN mode by programming software in a personal computer. If EXTR instruction is written during RUN while communication or if EXTR instruction is deleted in RUN mode, communication may be disabled after that. (In such a case, set the PLC to STOP, and then to RUN mode again to initialize the status.)

5. When using the E500 Series

Parameters Nos. 922 and 923 in the E500 Series cannot be used in inverter communication.

7.3 Inverter Operation Monitoring Instruction (PLC←Inverter) [EXTR K10]

EXTR K10 instruction reads the operation status of an inverter to the PLC.

7.3.1 Function and operation

When an "instruction code" specified for computer link operation in inverters is specified in EXTR instruction, a value in the inverter is read to (D•).

1. Applicable devices

Operand type	Bit device							Word device									Others		
	System/User							Digit specification				System/ User			Index		Constant		Pointer
	X	Y	M	T	C	S	KnX	KnY	KnM	KnS	T	C	D	V	Z	Modification	K	H	P
(S)																	✓	✓	
(S1•)												✓			✓		✓	✓	
(S2•)												✓			✓		✓	✓	
(D•)								✓	✓	✓		✓			✓				

2. Program example

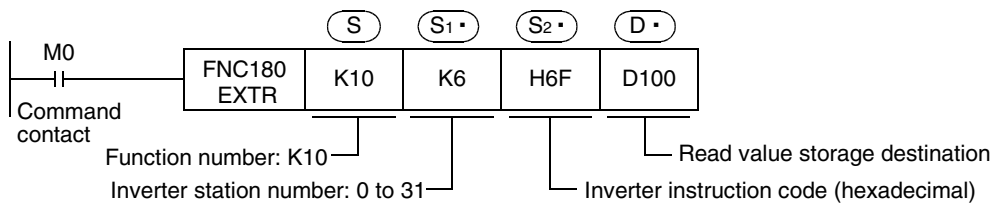

7.3.2 Inverter instruction codes

The table below shows inverter instruction codes which can be specified in (S2•). For the instruction codes, refer to the pages explaining computer link in detail in each inverter manual.

(S2•) Inverter instruction code (hexadecimal)	Read contents	Applicable inverter		
		A500	E500	S500
H7B	Operation mode	✓	✓	✓
H6F	Output frequency [speed]	✓	✓	✓
H70	Output current	✓	✓	✓
H71	Output voltage	✓	✓	—
H72	Special monitor	✓	—	—
H73	Special monitor selection No.	✓	—	—
H74	Alarm definition	✓	✓	✓
H75	Alarm definition	✓	✓	✓
H76	Alarm definition	✓	✓	—
H77	Alarm definition	✓	✓	—
H7A	Inverter status monitor	✓	✓	✓
H6E	Set frequency read (EEPROM)	✓	✓	✓
H6D	Set frequency read (RAM)	✓	✓	✓
H7F	Link parameter expansion setting	These codes cannot be specified in (S2•) in EXTR K10 instruction. They are automatically processed when a "second parameter specification code" is specified in EXTR K12 instruction.		
H6C	Second parameter changing			

7.4 Inverter Operation Control Instruction (PLC→Inverter) [EXTR K11]

This instruction writes a control value required to operate an inverter from the PLC to the inverter.

7.4.1 Function and operation

When an "instruction code" specified for computer link operation in inverters is specified in EXTR instruction, a value specified in (S3) is written to the specified item in the inverter.

1. Applicable devices

Operand type	Bit device							Word device							Others					
	System/User							Digit specification				System/ User			Index			Constant		Pointer
	X	Y	M	T	C	S	KnX	KnY	KnM	KnS	T	C	D	V	Z	Modification	K	H	P	
(S)																	✓	✓		
(S1)													✓			✓	✓	✓		
(S2)													✓			✓	✓	✓		
(S3)							✓	✓	✓	✓			✓			✓	✓	✓		

2. Program example

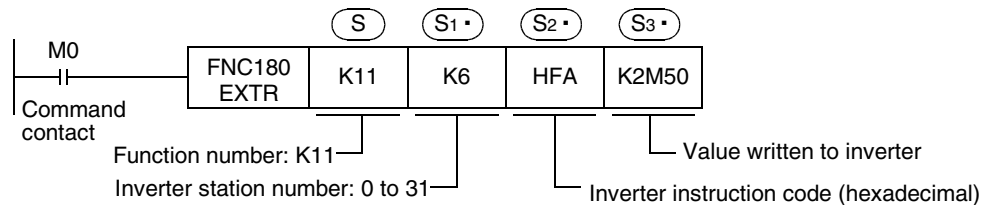

7.4.2 Inverter instruction codes

The table below shows inverter instruction codes which can be specified in (S2). For the instruction codes, refer to the pages explaining computer link in detail in each inverter manual.

(S2) Inverter instruction code (hexadecimal)	Read contents	Applicable inverter		
		A500	E500	S500
HFB	Operation mode	✓	✓	✓
HF3	Special monitor selection No.	✓	—	—
HFA	Run command	✓	✓	✓
HEE	Set frequency write (EEPROM)	✓	✓	✓
HED	Set frequency write (RAM)	✓	✓	✓
HFD*1	Inverter reset	✓	✓	✓
HF4	Alarm definition batch clear	✓	✓	✓
HFC	Parameter all clear	✓	✓	✓
HFC	User clear	✓	—	—

*1. The instruction code "HFD (inverter reset)" does not request response from the inverter. Accordingly, even if inverter reset is executed to a station number in which an inverter is not connected, error does not occur.
 It takes about 2.2 seconds to complete execution of inverter reset.

7.5 Inverter Parameter Reading Instruction (PLC←Inverter) [EXTR K12]

This instruction reads a parameter of an inverter to the PLC.

7.5.1 Function and operation

When a parameter number of an inverter is specified in EXTR instruction, the value of the parameter in the inverter is read to (D•).

1. Applicable devices

Operand type	Bit device							Word device									Others		
	System/User							Digit specification				System/ User			Index		Constant		Pointer
	X	Y	M	T	C	S	KnX	KnY	KnM	KnS	T	C	D	V	Z	Modification	K	H	P
(S)																	✓	✓	
(S1•)												✓			✓		✓	✓	
(S2•)												✓			✓		✓	✓	
(D•)												✓			✓				

2. Program example

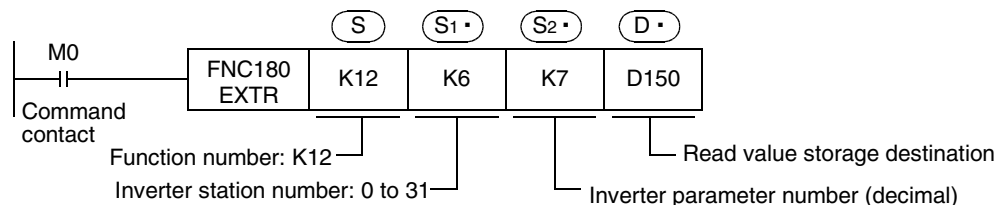

7.5.2 Inverter parameter number

Refer to related data shown later.

7.5.3 Program example of "second parameter specification code"

In the program example shown below, the parameter number 201 (frequency: 201, time: 1201, motor rotation direction: 2201) is read from the A500 inverter whose station number is 6.
 Read devices: D100 = Motor rotation direction, D101 = Frequency, D102 = Time

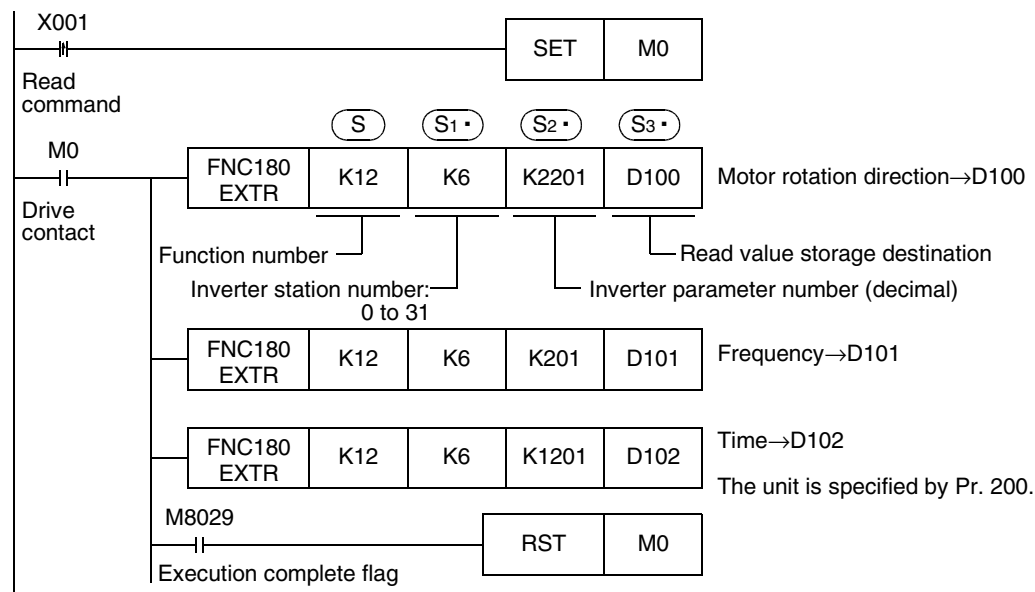

7.6 Inverter Parameter Writing Instruction (PLC→Inverter) [EXTR K13]

This instruction writes a value from the PLC to a parameter in an inverter.

7.6.1 Function and operation

When a parameter number in an inverter is specified in EXTR instruction, the value of (S3•) is written to the specified item in the inverter.

1. Applicable devices

Operand type	Bit device							Word device							Others					
	System/User							Digit specification				System/ User			Index			Constant		Pointer
	X	Y	M	T	C	S	KnX	KnY	KnM	KnS	T	C	D	V	Z	Modification	K	H	P	
(S)																	✓	✓		
(S1•)													✓			✓	✓	✓		
(S2•)													✓			✓	✓	✓		
(S3•)													✓			✓	✓	✓		

2. Program example

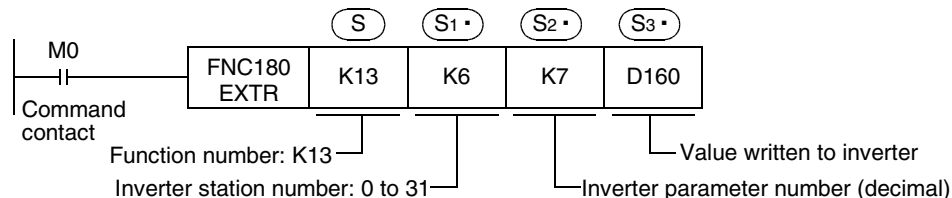

7.6.2 Inverter parameter number

Refer to related data shown later.

7.6.3 Program example of "second parameter specification code"

In the program example shown below, data is written from the PLC to parameter number 201 (frequency: 201, time: 1201, motor rotation direction: 2201) in the A500 inverter.

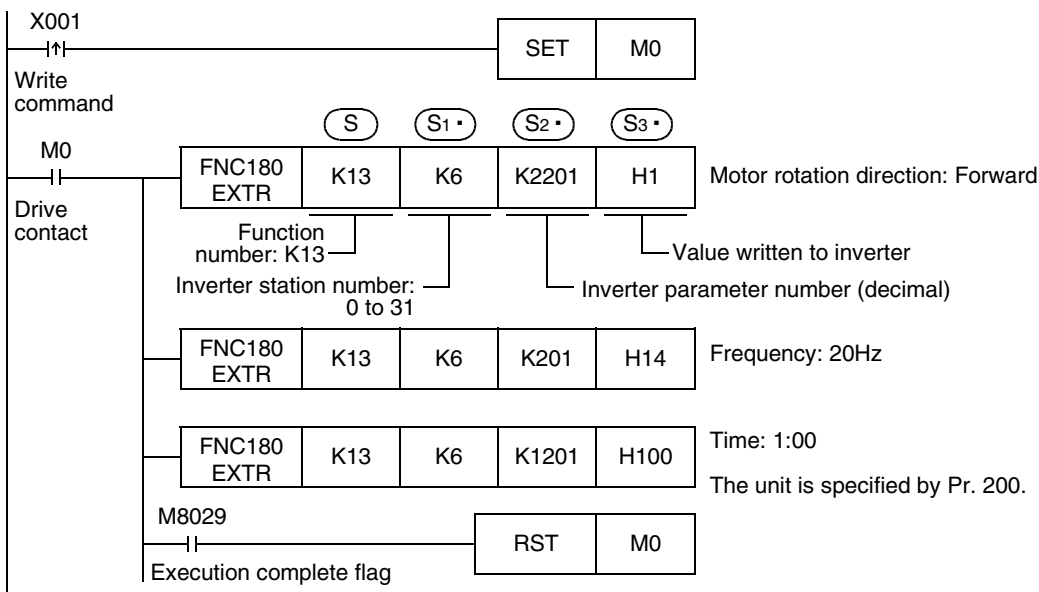

7.7 Second Parameter Specification Codes

When handling the following parameters in computer link operation, it is necessary to select second parameters.

In EXTR K12 and EXTR K13 instructions, when a value shown in the tables below is set to $(S2)$, the extension parameter and second parameter are automatically overwritten, and the parameter values are then read or written.

7.7.1 S500 Series

1. Second parameter specification codes for parameter numbers C2 to C7

Parameter No.	Name	Second parameter specification code [Value to be specified in $(S2)$ in EXTR instruction for parameter No. (decimal)]		
		Offset/Gain (H00)	Analog (H01)	Terminal analog value (H02)
C2	Frequency setting voltage bias frequency	902	1902	2902
C3	Frequency setting voltage bias	903	1903	2903
C4	Frequency setting voltage gain	904	1904	2904
C5	Frequency setting current bias frequency	905	1905	2905
C6	Frequency setting current bias	906	1906	2906
C7	Frequency setting current gain	907	1907	2907

7.7.2 E500 Series

1. Second parameter specification codes for parameter numbers 902 to 905

Parameter No.	Name	Second parameter specification code [Value to be specified in $(S2)$ in EXTR instruction for parameter No. (decimal)]		
		Offset/Gain (H00)	Analog (H01)	Terminal analog value (H02)
902	Frequency setting voltage bias	902	1902	2902
903	Frequency setting voltage gain	903	1903	2903
904	Frequency setting current bias	904	1904	2904
905	Frequency setting current gain	905	1905	2905

7.7.3 A500 Series

1. Second parameter specification codes for parameter numbers 201 to 230

Parameter No.	Name	Second parameter specification code [Value to be specified in (S2) in EXTR instruction for parameter No. (decimal)]		
		Operation frequency read/write	Time read/write	Rotation direction write/read
201	Program set 1	201	1201	2201
202	Program set 1	202	1202	2202
203	Program set 1	203	1203	2203
204	Program set 1	204	1204	2204
205	Program set 1	205	1205	2205
206	Program set 1	206	1206	2206
207	Program set 1	207	1207	2207
208	Program set 1	208	1208	2208
209	Program set 1	209	1209	2209
210	Program set 1	210	1210	2210
211	Program set 2	211	1211	2211
212	Program set 2	212	1212	2212
213	Program set 2	213	1213	2213
214	Program set 2	214	1214	2214
215	Program set 2	215	1215	2215
216	Program set 2	216	1216	2216
217	Program set 2	217	1217	2217
218	Program set 2	218	1218	2218
219	Program set 2	219	1219	2219
220	Program set 2	220	1220	2220
221	Program set 3	221	1221	2221
222	Program set 3	222	1222	2222
223	Program set 3	223	1223	2223
224	Program set 3	224	1224	2224
225	Program set 3	225	1225	2225
226	Program set 3	226	1226	2226
227	Program set 3	227	1227	2227
228	Program set 3	228	1228	2228
229	Program set 3	229	1229	2229
230	Program set 3	230	1230	2230

2. Second parameter specification codes for parameter numbers 902 to 905

Parameter No.	Name	Second parameter specification code [Value to be specified in (S2) in EXTR instruction for parameter No. (decimal)]		
		Offset/Gain (H00)	Analog (H01)	Terminal analog value (H02)
902	Frequency setting voltage bias	902	1902	2902
903	Frequency setting voltage gain	903	1903	2903
904	Frequency setting current bias	904	1904	2904
905	Frequency setting current gain	905	1905	2905

A	Common Items
B	N:N Network
C	Parallel Link
D	Computer Link
E	Inverter Communication
F	Non-Protocol Communication (RS/RS2 Instruction)
G	Non-Protocol Communication (FX2N-232IF)
H	Programming Communication
I	Remote Maintenance

8. Practical Program Examples (for FX2N and FX2NC PLCs)

This chapter explains practical programs for inverter communication.

8.1 Practical Example 1

This fundamental program example monitors operations of an inverter, controls operations of an inverter and writes parameters to an inverter.

8.1.1 System configuration example

An FX PLC is connected to an inverter.

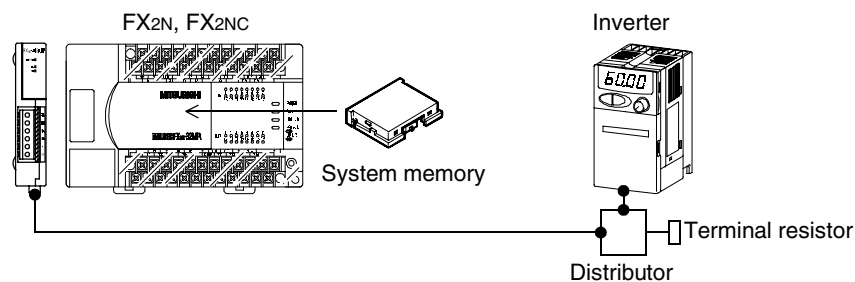

8.1.2 Contents of operation

As an example of operation control, an inverter can be stopped (X000), rotated forward (X001) and rotated reverse (X002).

By changing the contents of D10, the speed can be changed.

The contents of D10 can be changed from a sequence program or display unit.

8.1.3 Program example

1. Writing parameters to an inverter while the PLC is in RUN mode

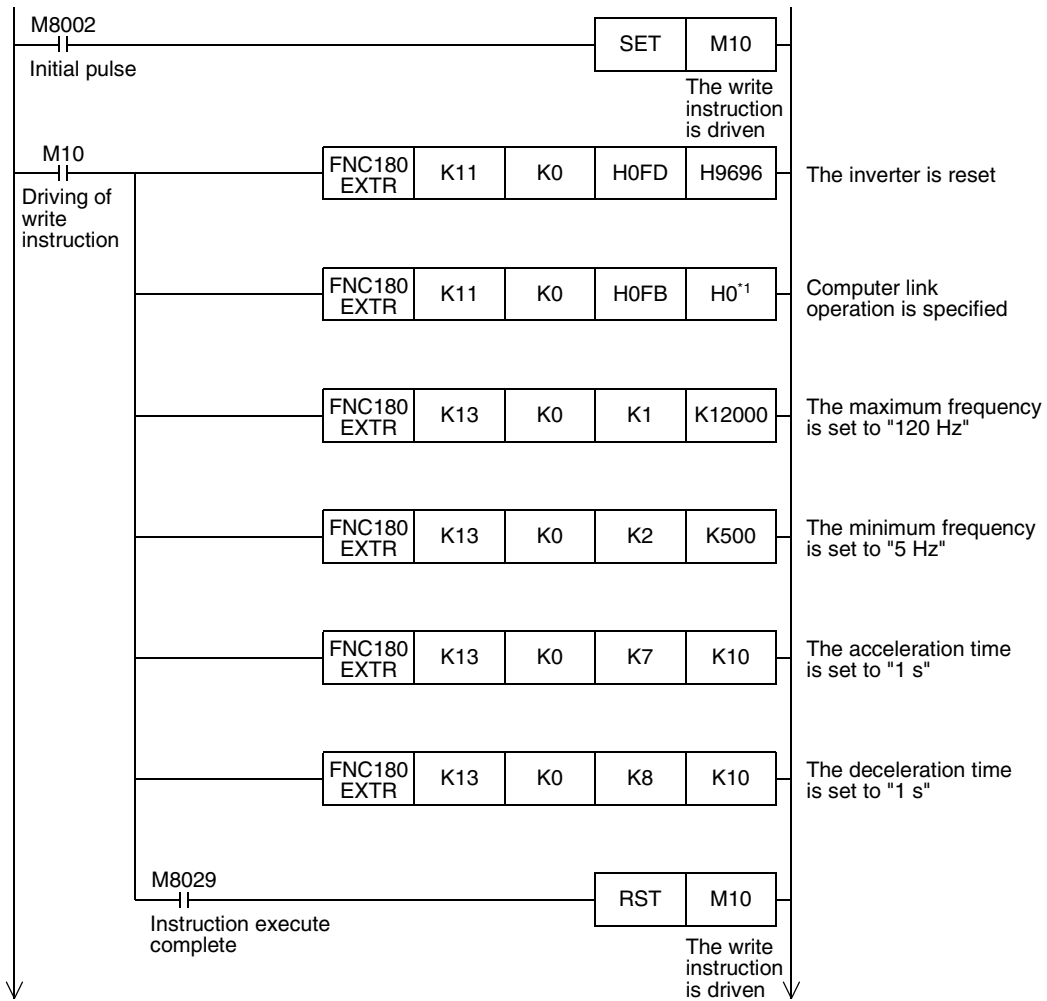

*1. When using an E500 Series inverter, use "H2" to specify computer link operation.

2. Changing the speed using a sequence program

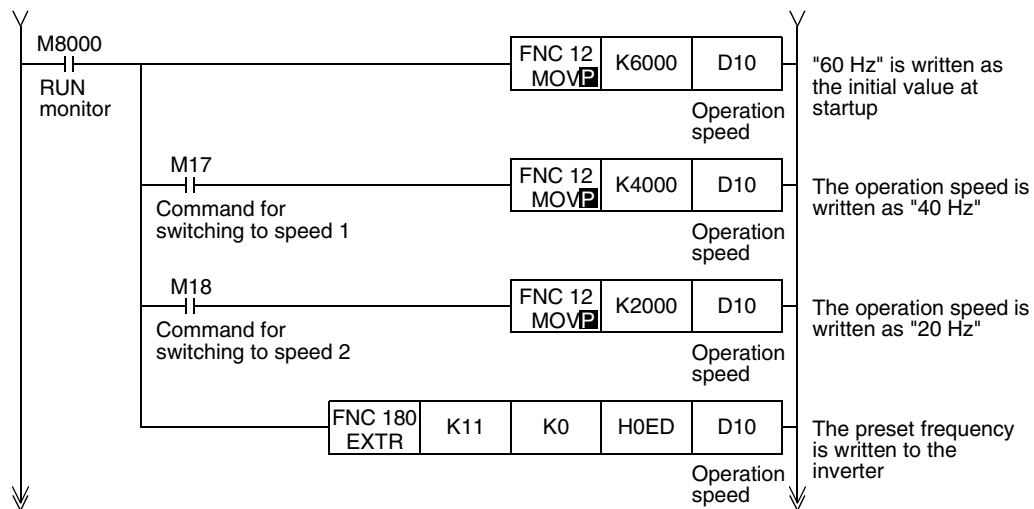

A	Common Items
B	N:N Network
C	Parallel Link
D	Computer Link
E	Inverter Communication
F	Non-Protocol Communication (RS/RS2 Instruction)
G	Non-Protocol Communication (FX2N-232IF)
H	Programming Communication
I	Remote Maintenance

3. Controlling operations of an inverter

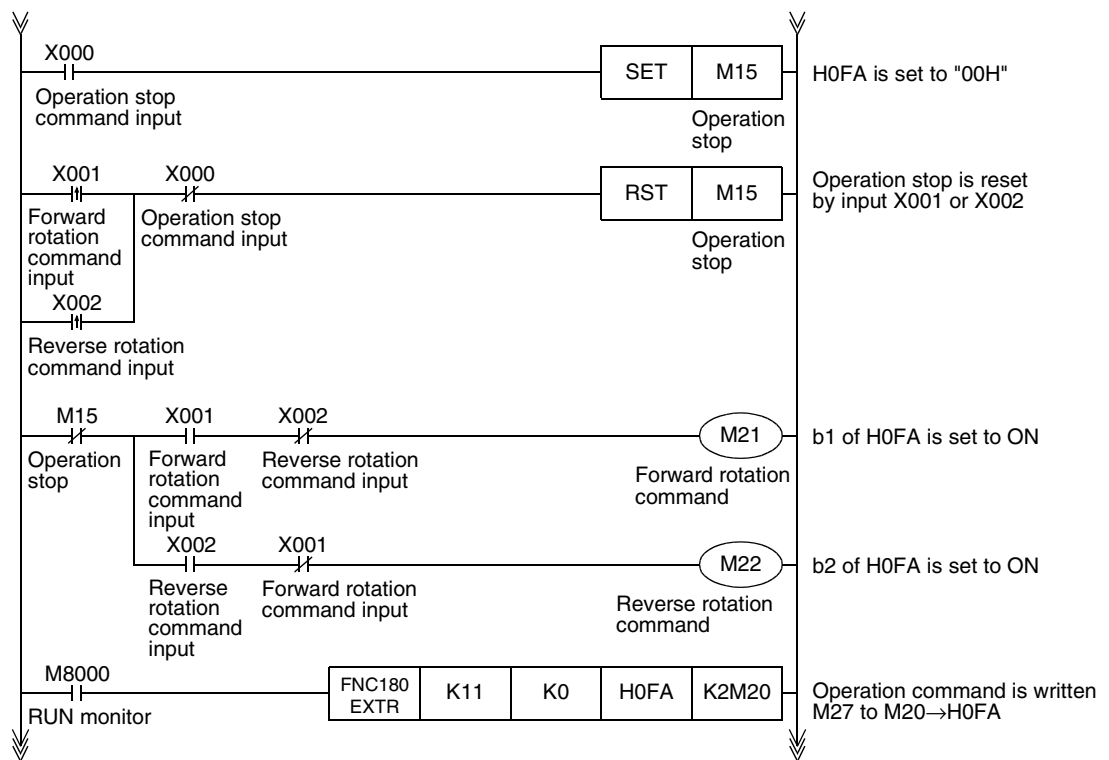

4. Monitoring operations of an inverter

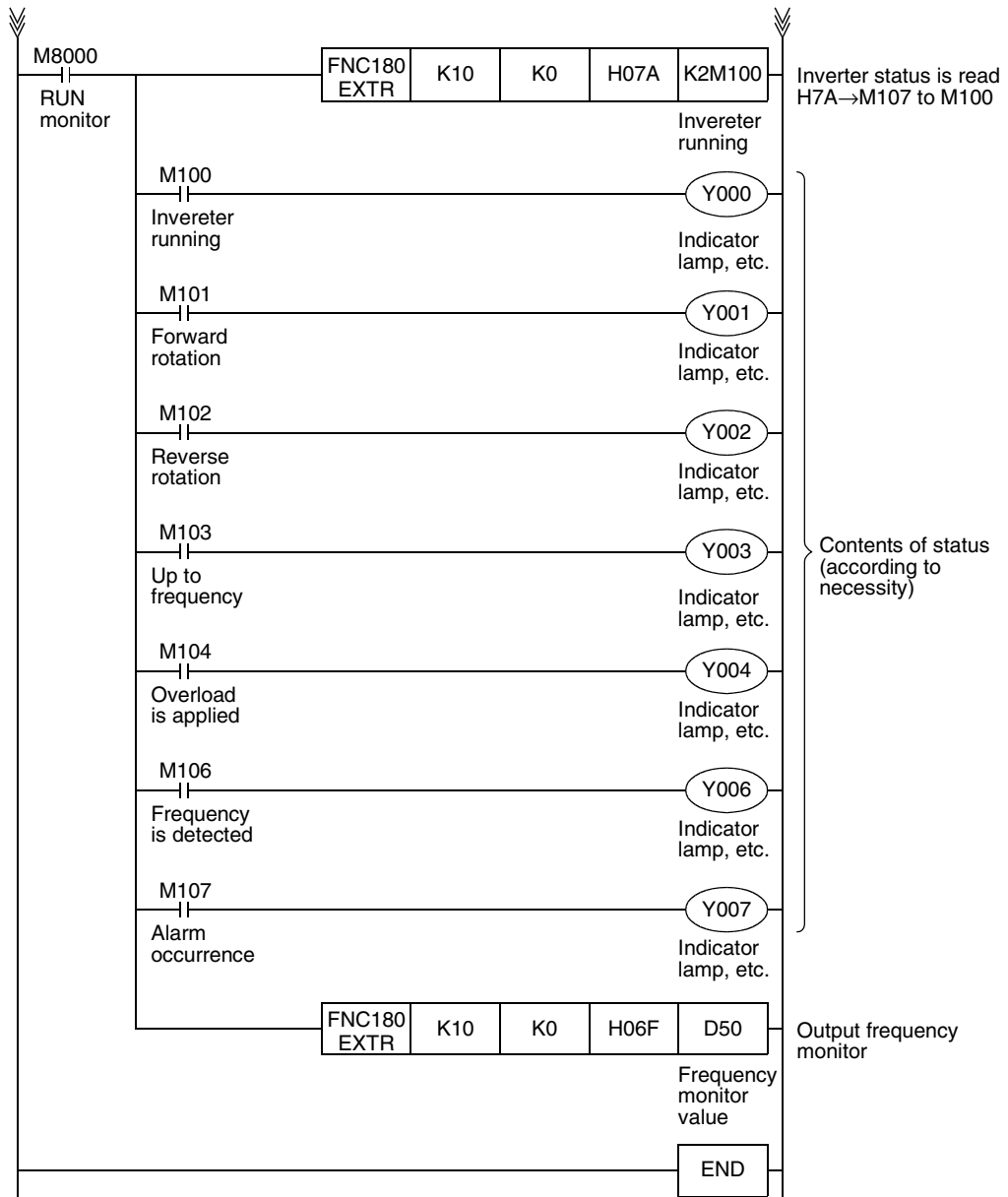

A	Common Items
B	N:N Network
C	Parallel Link
D	Computer Link
E	Inverter Communication
F	Non-Protocol Communication (RS/RS2 Instruction)
G	Non-Protocol Communication (FX2N-232IF)
H	Programming Communication
I	Remote Maintenance

8.2 Practical Example 2

This program executes the same control as practical example 1 shown above.

8.2.1 System configuration example

An FX PLC is connected to an inverter.

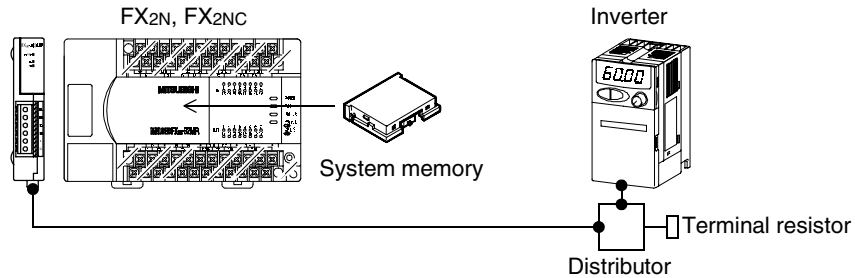

8.2.2 Contents of operation

The differences from practical example 1 are that the inverter status is not read while data is written to an inverter, and that the contents to be written are detected and written to an inverter only when the contents to be written are changed.

Because communication between the PLC and the inverter is minimum in this program, the communication time is reduced and the response time is improved.

8.2.3 Program example

1. Writing parameters to an inverter while the PLC is in RUN mode

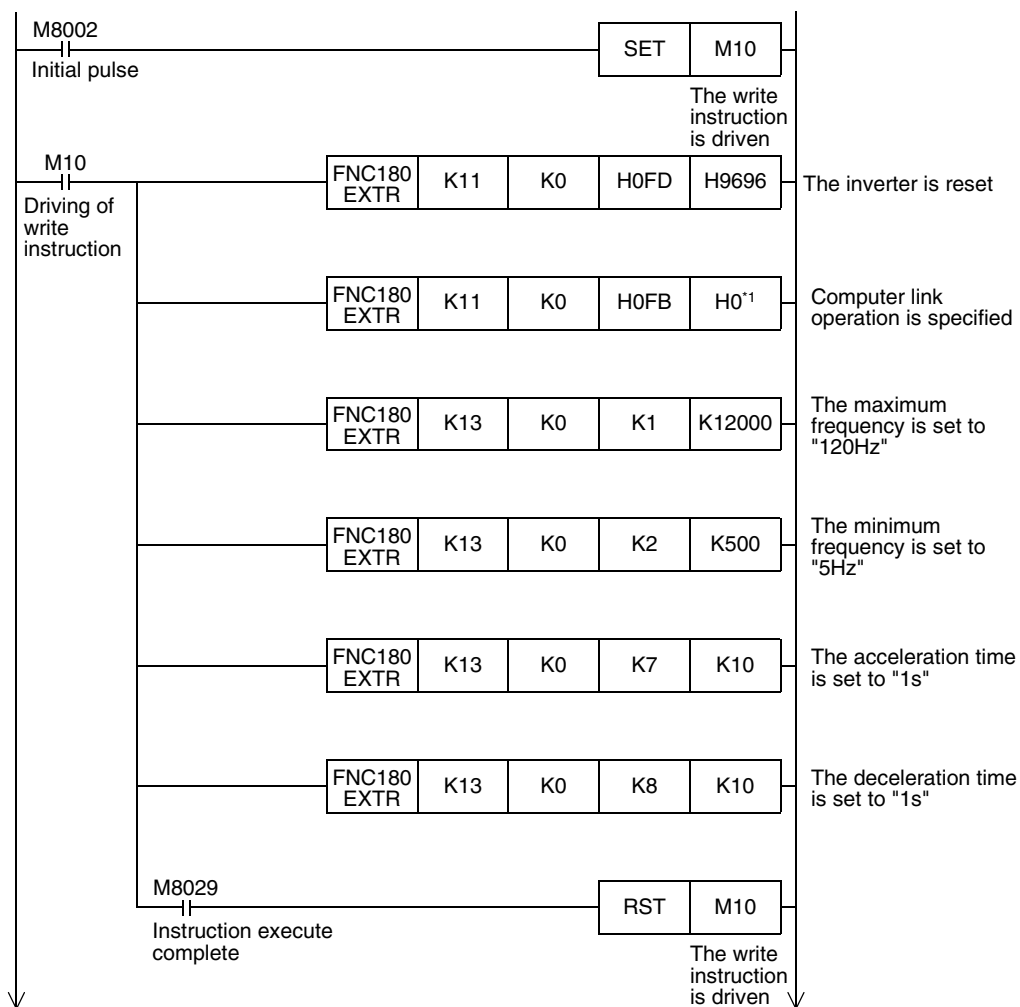

*1. When using an E500 Series inverter, use "H2" to specify computer link operation.

A	Common Items
B	N:N Network
C	Parallel Link
D	Computer Link
E	Inverter Communication
F	Non-Protocol Communication (RS/RS2 Instruction)
G	Non-Protocol Communication (FX2N-232IF)
H	Programming Communication
I	Remote Maintenance

2. Changing the speed using a sequence program

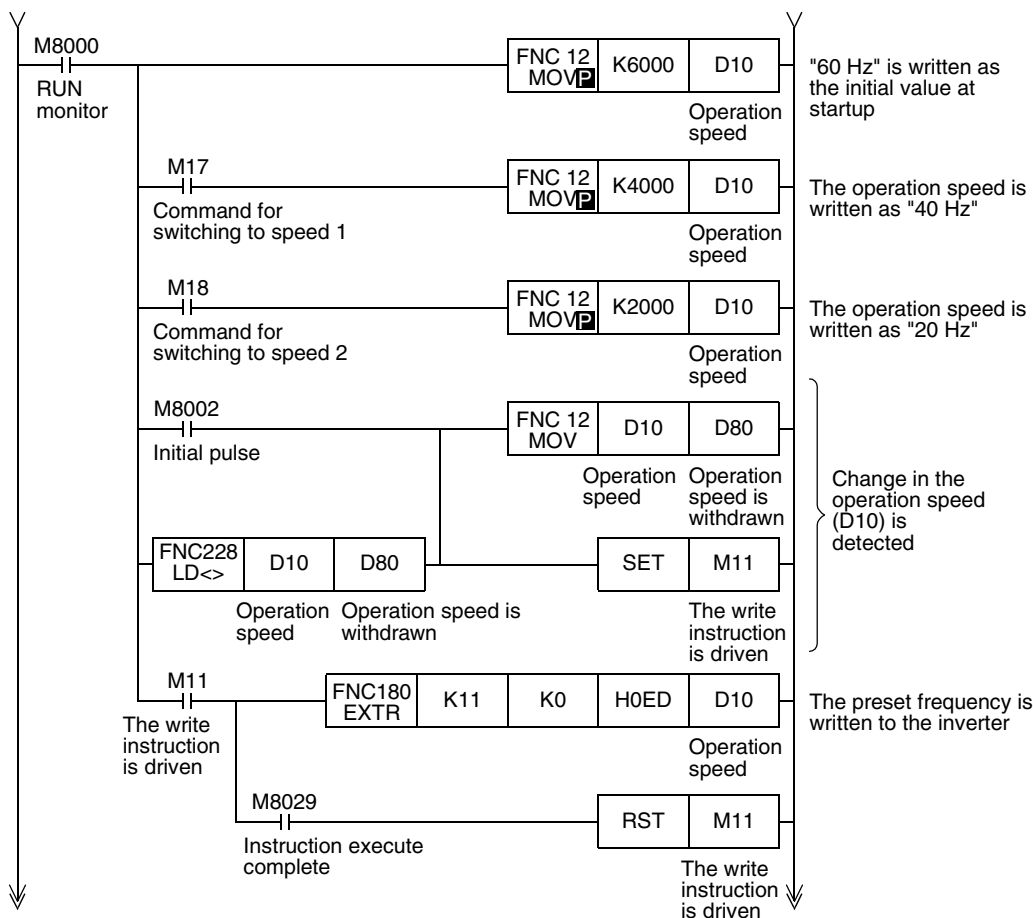

3. Controlling operations of an inverter

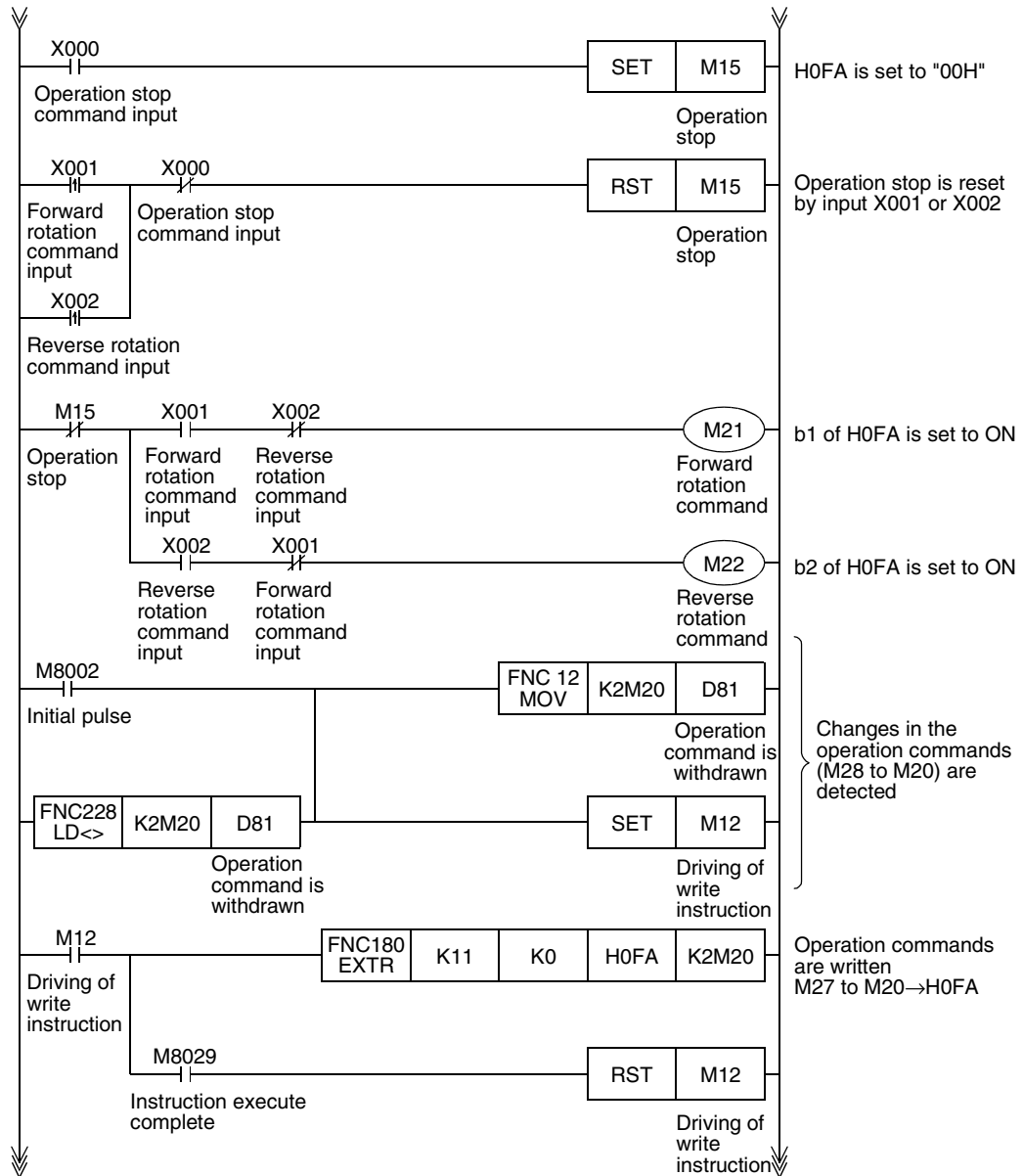

A	Common Items
B	N:N Network
C	Parallel Link
D	Computer Link
E	Inverter Communication
F	Non-Protocol Communication (RS/RS2 Instruction)
G	Non-Protocol Communication (FX2N-232IF)
H	Programming Communication
I	Remote Maintenance

4. Monitoring operations of an inverter

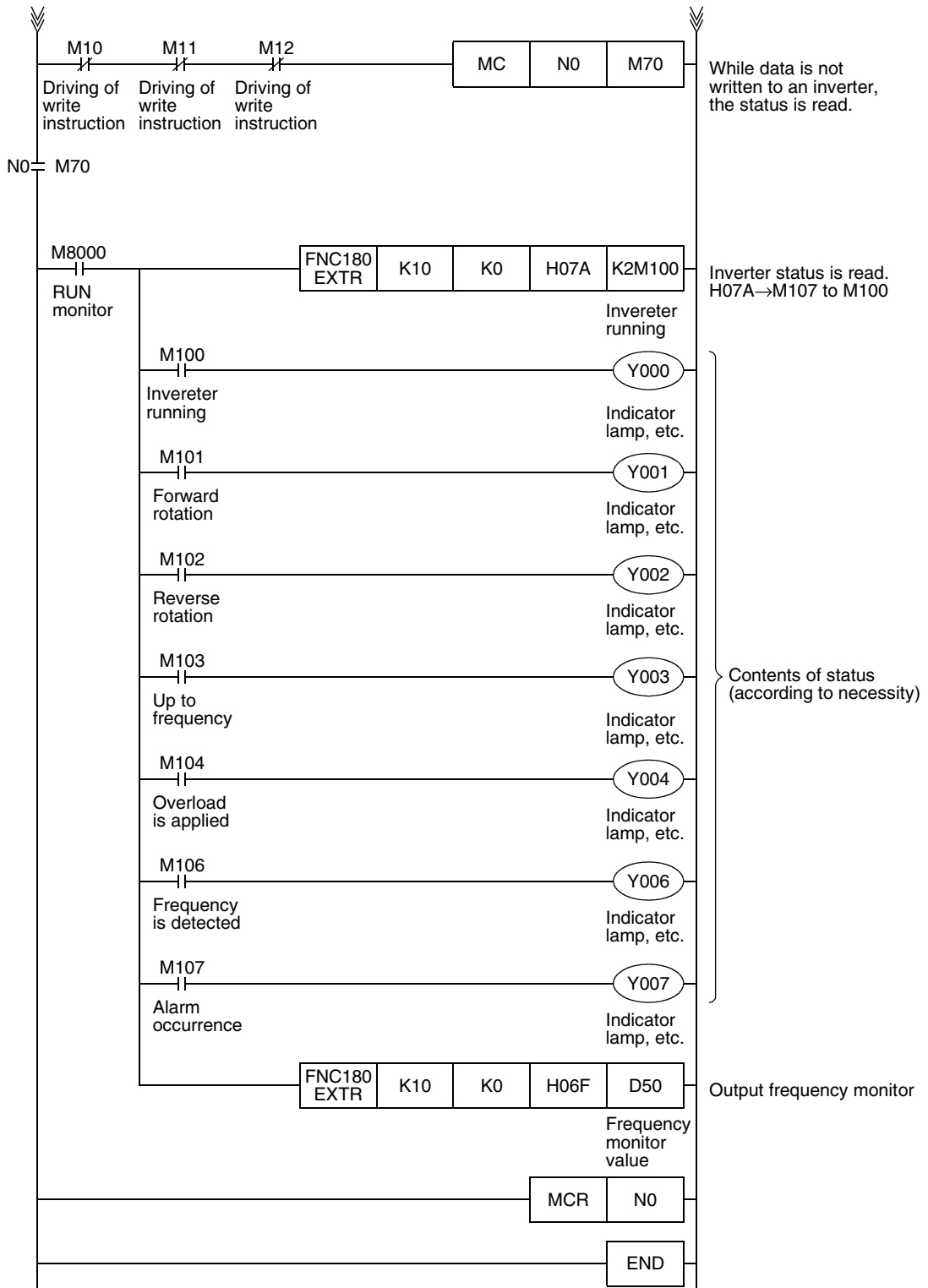

9. Creating Programs (for FX3U and FX3UC PLCs)

This chapter explains how to create programs which change parameters of inverters and give operation commands to inverters.

In explanation, a program example is shown for each applied instruction.

9.1 Differences between FX2N/FX2NC PLCs and FX3U/FX3UC PLCs

Instruction devices used in inverter communication are different between FX3U/FX3UC PLCs and FX2N/FX2NC PLCs.

When utilizing a program for FX2N/FX2NC PLCs for FX3U/FX3UC PLCs, change devices in accordance with the tables below.

1. Inverter communication instructions

Function	FX2N,FX2NC	FX3U,FX3UC
Monitoring operation of an inverter	EXTR(K10)	IVCK
Controlling operation of an inverter	EXTR(K11)	IVDR
Reading parameters from an inverter	EXTR(K12)	IVRD
Writing parameters to an inverter	EXTR(K13)	IVWR
Writing parameters to an inverter at one time	—	IVBWR

2. Related devices

1) Bit devices

Function	FX2N,FX2NC	FX3U,FX3UC	
		ch1	ch2
Instruction execution complete	M8029	M8029	M8029
Communication error (shared by all communication)	M8063*1	M8063	M8438
Inverter communicating	M8155	M8151	M8156
Inverter communication error	M8156	M8152	M8157
Inverter communication error latch	M8157	M8153	M8158
IVBWR instruction error	—	M8154	M8159

*1. In the FX2N and FX2NC PLCs, M8063 does not turn ON when an inverter communication error occurs.

2) Word devices

Function	FX2N,FX2NC	FX3U,FX3UC	
		ch1	ch2
Error code (shared by all communication)	D8063	D8063	D8438
Response wait time of inverter communication	D8154	D8150	D8155
Step number of instruction during inverter communication	D8155	D8151	D8156
Inverter communication error code	D8156	D8152	D8157
Inverter communication error occurrence step	D8157	D8153	D8158
IVBWR instruction error parameter number	—	D8154	D8159

9.2 Contents of Related Devices

The tables below show devices used for inverter communication in FX3U and FX3UC PLCs.

1. Bit devices

Device No.		Name	Description	R/W
ch1	ch2			
M8029		Instruction execution complete	Turns ON when execution of inverter communication instruction is completed, and remains ON for 1 scan. Turns ON also when execution of instruction is completed if inverter communication error flag (M8152 or M8157) turns ON.	R
M8063	M8438	Serial communication error ^{*1}	Turns ON when an error occurs in any type of communication.	R
M8151	M8156	Inverter communicating	Remains ON while inverter communication is being executed.	R
M8152	M8157	Inverter communication error ^{*1}	Turns ON when an error occurs during communication with an inverter.	R
M8153	M8158	Inverter communication error latch ^{*1}	Turns ON when an error occurs during communication with an inverter.	R
M8154	M8159	IVBWR instruction error ^{*1}	Turns ON when an error is caused by IVBWR instruction.	R

R: For reading only (used as a contact in program)

*1. Cleared when the PLC mode is changed from STOP to RUN.

2. Word devices

Device No.		Name	Description	R/W
ch1	ch2			
D8063	D8438	Error code for serial communication ^{*1}	Stores a communication error code.	R
D8150	D8155	Inverter communication response waiting time	Sets the response wait time of inverter communication.	R/W
D8151	D8156	Step number of instruction executing inverter communication	Stores the step number of an instruction during inverter communication.	R
D8152	D8157	Error code for inverter communication ^{*1}	Stores an inverter communication error code.	R
D8153	D8158	Step where inverter communication error occurred ^{*1}	Latches a step number in which inverter communication error has occurred.	R
D8154	D8159	Error parameter number of IVBWR instruction ^{*1}	Stores a parameter number in which an IVBWR instruction error has occurred.	R

R: For reading only

W: For writing only

*1. Cleared when the PLC mode is changed from STOP to RUN.

9.3 Common Items in Inverter Communication Instructions

9.3.1 Inverter communication types (IVCK to IVBWR)

An inverter execute communication using the following applied instructions. There are five types of applied instructions, "IVCK (FNC270) to IVBWR (FNC274)", depending on the data communication direction and parameter writing/reading direction.

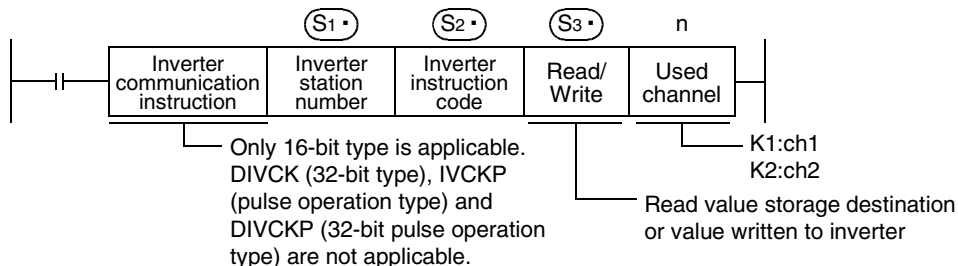

Instruction	Function	Control direction	Detailed explanation
IVCK(FNC270)	Monitors operations of an inverter.	PLC ← inverter	9.4
IVDR(FNC271)	Controls operations of an inverter.	PLC → inverter	9.5
IVRD(FNC272)	Reads a parameter in an inverter.	PLC ← inverter	9.6
IWR(FNC273)	Writes a parameter in an inverter.	PLC → inverter	9.7
IVBWR(FNC274)	Writes parameters in an inverter at one time.	PLC → inverter	9.8

9.3.2 Function and operation

1. Communication start timing

At the rising edge (OFF→ON) of the drive condition, the PLC starts communication with an inverter. Even if the drive condition turns OFF during communication with an inverter, the PLC executes communication until the end. When the drive condition is always ON, the PLC executes communication repeatedly.

2. Simultaneous driving of instructions and communication processing

- 1) Driving instructions at the same time
 - Two or more IVCK (FNC270) to IVBWR (FNC274) instructions can be programmed, and driven at the same time.
 - When two or more instructions are driven at the same time in the channel used for communication, the next inverter communication instruction in the program is executed after the current communication with an inverter has finished.

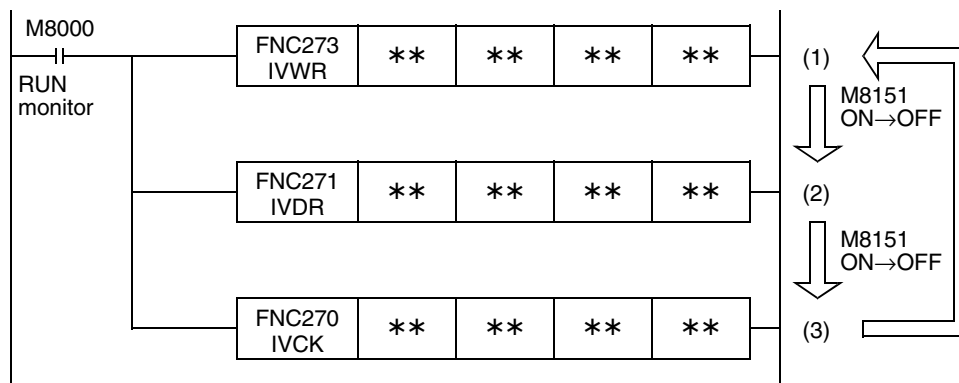

- Even if the drive condition turns ON, the PLC does not start execution of an inverter communication instruction until the communication port busy flag M8151 turns OFF from ON, if M8151 was set to ON by another inverter communication instruction.
 The PLC waits for 15 ms after freeing the communication port, and then executes inverter communication instructions driven in the next step and later in turn.

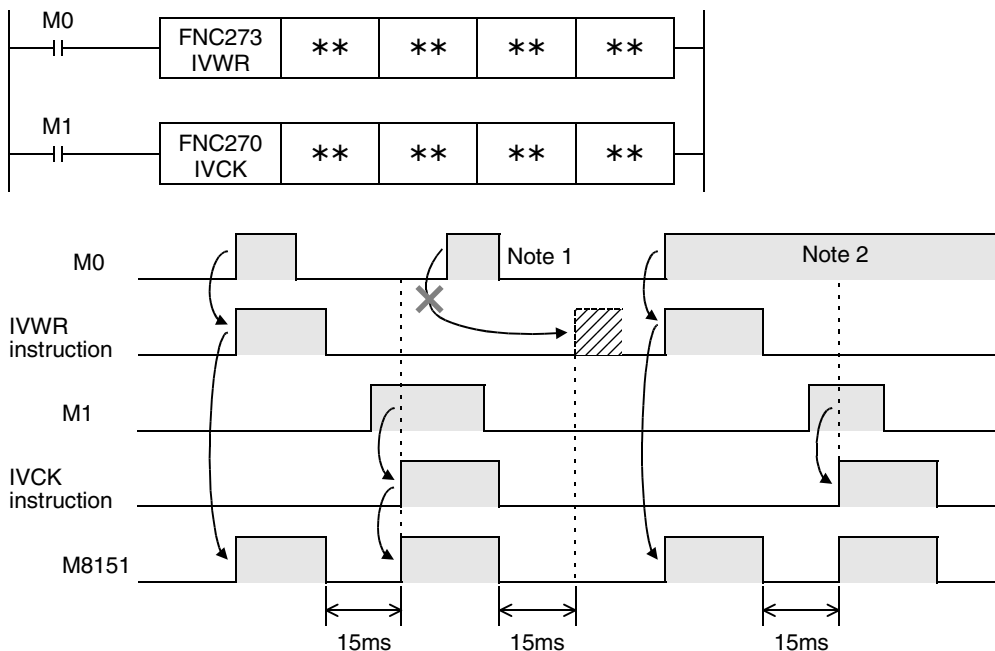

Note 1: If the drive contact is OFF in 15 ms after M8151 is turned OFF from ON, the instruction cannot be executed.
 Note 2: When two or more instructions are driven at the same time during communication, the next inverter communication instruction in the program is executed after the current communication with an inverter is finished.

2) Cautions on programming

When communicating with inverters for two or more items, let the drive contact for inverter communication instruction remain ON until sending is completed. After communication with all inverters is finished, set the drive contact to OFF using the instruction execution complete flag M8029.

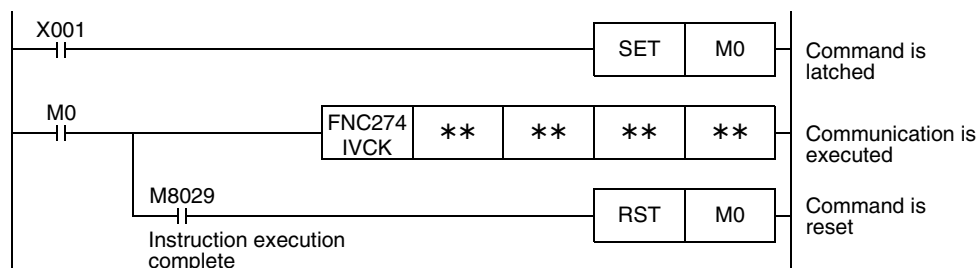

3. Communication complete flag (M8029)

When communication with an inverter is finished, the instruction execution complete flag M8029 turns ON, and remains ON for 1 scan.
 For the M8029 use method, refer to program examples shown below.

9.3.3 Instruction completion and error flag operation

When two or more inverter communication instructions are programmed, the following flags turn ON or OFF according to the execution result of each inverter communication instruction. To acquire the result of each inverter communication instruction, make sure to provide these flags just below each inverter communication instruction.

Device number		Description	Device number		Description
ch1	ch2		ch1	ch2	
M8029		Instruction execution complete	D8063	D8438	Serial communication error code
M8063	M8438	Serial communication error	D8152	D8157	Inverter communication error code
M8152	M8157	Inverter communication error	D8153	D8158	Step in which inverter communication error occurred
M8153	M8158	Inverter communication error lach	D8154	D8159	IBWR error parameter number
M8154	M8159	IVBWR instruction error			

1. Operation of M8029 (instruction execution complete flag)

The operation of M8029 (instruction execution complete flag) is the state that IVDR instruction completed while M0, M2 are off and M1 is ON.

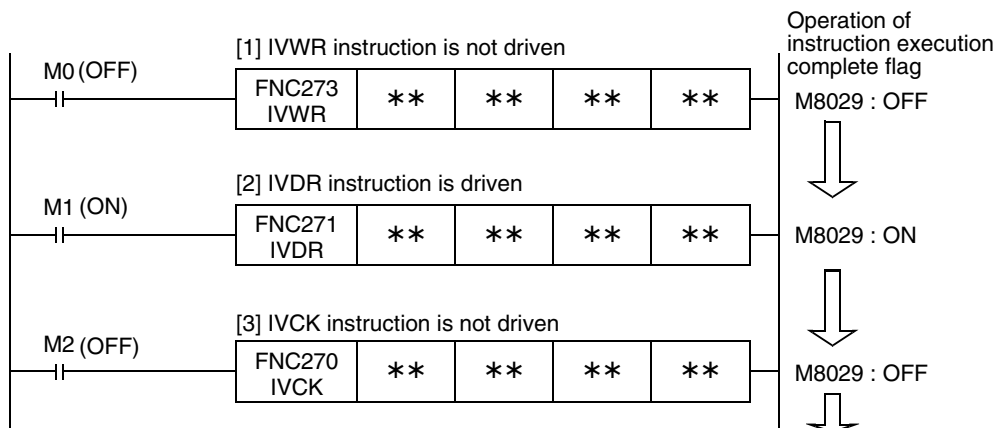

2. Processing of communication errors

The following two types of processing are executed for communication errors. The parity error/overflow error/framing error flags (shown in the upper column) turns ON when an error occurs in any type of communication. The error flag shown in the lower column turns ON when an error occurs during communication with an inverter.

Bit device				Word device				Description
ch1	ch2	ch1	ch2	ch1	ch2	ch1	ch2	
M8063	M8438	M8152	M8157	M8153	M8159	D8063	D8438	Parity error, overrun error or framing error
ON		OFF		OFF		6301	3801	
ON		ON		ON (only at first time)		6320	3820	Any inverter communication error other than those above

When inverter communication error flag turns ON, the step number is stored in inverter communication error occurrence step device (D8153 or D8158). Create the program shown below for each corresponding instruction to check inverter communication error code (stored in D8152 or D8157).

3. Program example

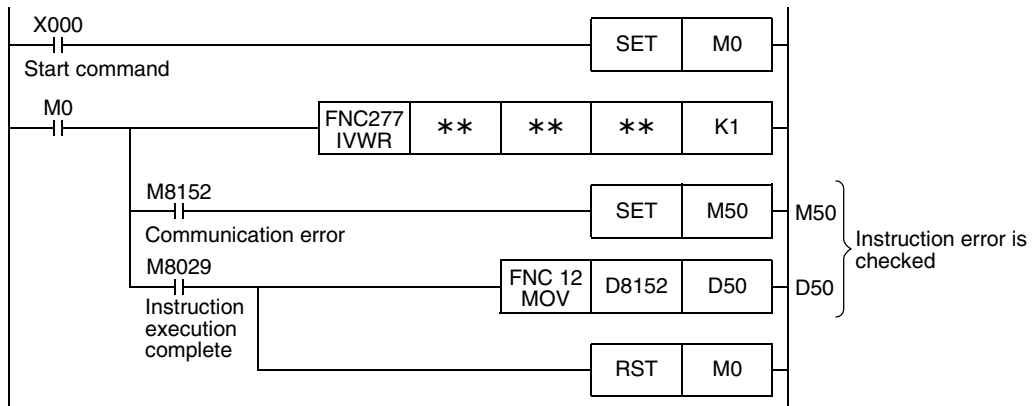

9.3.4 Cautions on programming

1. Using inverter communication instruction together with another instruction

- Inverter communication instruction using the (ch 1) cannot be used together with RS instruction.
- Inverter communication instruction cannot be used together with RS2 instruction if RS2 instruction uses the same channel.

2. When programming inverter communication instruction in a state of STL instruction

Make sure to let the state relay remain ON until communication with an inverter is completed. If the state relay is set to OFF during communication, inverter communication instruction is stopped in the middle of execution, and another inverter communication instruction cannot be started. Program a sequence while observing the following cautions

- Add M8029 (instruction execution complete flag) ON condition to the state relay transfer condition, and provide such interlock that the state relay ON/OFF status does not change during communication with an inverter.
 If the state relay is set to OFF during communication, the remaining communication can be completed by setting the state relay to ON again.
- When resetting many state relays at one time using the ZRST (FNC 40) instruction, etc., make sure that the M8151 or M8156 (communication port busy) condition is OFF.

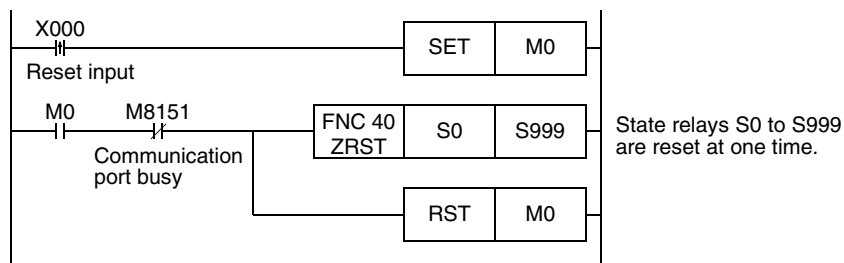

3. Using inverter communication instruction in a program flow

Inverter communication instruction cannot be used in the following program flows

Program flow disabling inverter communication instruction	Remarks
Between CJ and P instructions	Conditional jump
Between FOR and NEXT instructions	Repeat
Between P and SRET instructions	Subroutine
Between I and IRET instructions	Interrupt routine

4. Caution on write during RUN

- 1) Condition in which inverter communication instruction can be written:
 While the PLC is in the STOP status, inverter communication instruction can be written while RUN.
- 2) Condition in which inverter communication instruction cannot be written:
 Inverter communication instruction cannot be written during RUN by programming software in a personal computer.
 If inverter communication instruction is written during RUN while communication or if inverter communication instruction is deleted in RUN mode, communication may be disabled after that. (In such a case, set the PLC to STOP, and then to RUN again to initialize the status.)

5. When using the E500 Series

Parameters Nos. 922 and 923 in the E500 Series cannot be used in inverter communication.

A	Common Items
B	N:N Network
C	Parallel Link
D	Computer Link
E	Inverter Communication
F	Non-Protocol Communication (RS/RS2 Instruction)
G	Non-Protocol Communication (FX2N-232IF)
H	Programming Communication
I	Remote Maintenance

9.4 Inverter Operation Monitoring Instruction (PLC←Inverter) [FNC270 / IVCK]

IVCK instruction reads the operation status of an inverter to the PLC.

9.4.1 Function and operation

When an "instruction code" specified for computer link operation in the inverters is specified in IVCK (FNC270) instruction, a value in the inverter is read to (D•).

1. Applicable devices

Oper- and Type	Bit Devices							Word Devices										Others					
	System/User							Digit Specification				System/User				Special Unit	Index		Constant	Real Number	Charac-ter String	Pointer	
	X	Y	M	T	C	S	D□.b	KnX	KnY	KnM	KnS	T	C	D	R	U□\G□	V	Z	Modify	K	H	E	"□"
(S1•)														✓	✓	✓		✓	✓				
(S2•)														✓	✓	✓		✓	✓				
(D•)								✓	✓	✓				✓	✓	✓		✓					
n																			✓	✓			

2. Program example

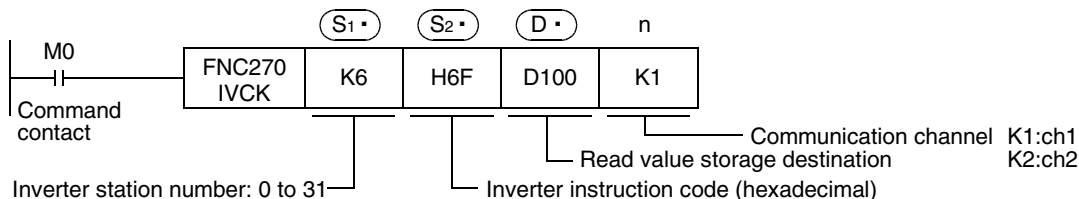

9.4.2 Inverter instruction codes

The table below shows inverter instruction codes which can be specified in (S2•). For the instruction codes, refer to the pages explaining computer link in detail in each inverter manual.

(S2•) Inverter Instruction code (hexadecimal)	Read contents	Applicable inverter						
		F700	A700	V500	F500	A500	E500	S500
H7B	Operation mode	✓	✓	✓	✓	✓	✓	✓
H6F	Output frequency [speed]	✓	✓	✓	✓	✓	✓	✓
H70	Output current	✓	✓	✓	✓	✓	✓	✓
H71	Output voltage	✓	✓	✓	✓	✓	✓	—
H72	Special monitor	✓	✓	✓	✓	✓	—	—
H73	Special monitor selection No.	✓	✓	✓	✓	✓	—	—
H74	Alarm definition	✓	✓	✓	✓	✓	✓	✓
H75	Alarm definition	✓	✓	✓	✓	✓	✓	✓
H76	Alarm definition	✓	✓	✓	✓	✓	✓	—
H77	Alarm definition	✓	✓	✓	✓	✓	✓	—
H79	Inverter status monitor (extended)	✓	✓	—	—	—	—	—
H7A	Inverter status monitor	✓	✓	✓	✓	✓	✓	✓
H6E	Set frequency read (EEPROM)	✓	✓	✓	✓	✓	✓	✓
H6D	Set frequency read (RAM)	✓	✓	✓	✓	✓	✓	✓
H7F	Link parameter expansion setting	These codes cannot be specified in (S2•) in IVCK instruction.						
H6C	Second parameter changing	They are automatically processed when a "second parameter specification code" is specified in IVRD instruction.						

9.5 Inverter Operation Control Instruction (PLC→Inverter) [FNC271 / IVDR]

This instruction writes a control value required to operate an inverter from the PLC to the inverter.

9.5.1 Function and operation

When an "instruction code" specified for computer link operation in the inverters is specified in IVDR (FNC271) instruction, a value specified in (S3•) is written to the specified item of the inverter.

1. Applicable devices

Oper- and Type	Bit Devices							Word Devices										Others					
	System/User							Digit Specification				System/User				Special Unit	Index			Const- ant	Real Number	Charac- ter String	Pointer
	X	Y	M	T	C	S	D□.b	KnX	KnY	KnM	KnS	T	C	D	R	U□\G□	V	Z	Modify	K	H	E	"□"
(S1•)																			✓	✓			
(S2•)																			✓	✓			
(S3•)								✓	✓	✓	✓								✓	✓			
n																			✓	✓			

2. Program example

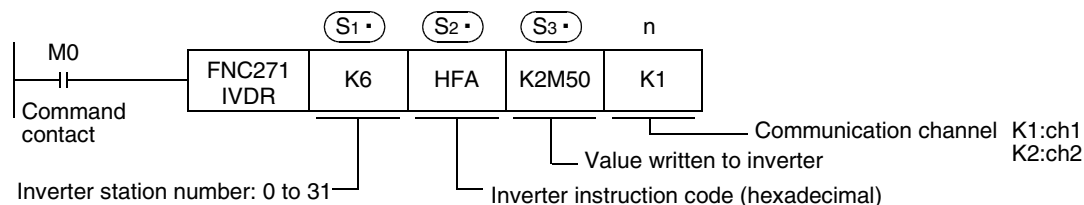

9.5.2 Inverter instruction codes

The table below shows inverter instruction codes which can be specified in (S2•). For the instruction codes, refer to the pages explaining computer link in detail in each inverter manual.

(S2•) Inverter Instruction code (hexadecimal)	Read contents	Applicable inverter						
		F700	A700	V500	F500	A500	E500	S500
HFB	Operation mode	✓	✓	✓	✓	✓	✓	✓
HF3	Special monitor selection No.	✓	✓	✓	✓	✓	—	—
HF9	Run command (extension)	✓	✓	—	—	—	—	—
HFA	Run command	✓	✓	✓	✓	✓	✓	✓
HEE	Set frequency write (EEPROM)	✓	✓	✓	✓	✓	✓	✓
HED	Set frequency write (RAM)	✓	✓	✓	✓	✓	✓	✓
HFD*1	Inverter reset	✓	✓	✓	✓	✓	✓	✓
HF4	Alarm definition batch clear	✓	✓	—	✓	✓	✓	✓
HFC	Parameter all clear	✓	✓	✓	✓	✓	✓	✓
HFC	User clear	✓	✓	—	✓	✓	—	—

*1. The instruction code "HFD (inverter reset)" does not request response from the inverter. Accordingly, even if inverter reset is executed to a station number in which an inverter is not connected, error does not occur. It takes about 2.2 seconds to complete execution of inverter reset.

9.6 Inverter Parameter Reading (PLC←Inverter) [FNC272 / IVRD]

This instruction reads a parameter of an inverter to the PLC.

9.6.1 Function and operation

When a parameter number of an inverter is specified in IVRD (FNC272) instruction, the value of the parameter is read to (D•).

1. Applicable devices

Oper- and Type	Bit Devices								Word Devices								Others							
	System/User								Digit Specification				System/User				Special Unit	Index			Con- stant	Real Number	Charac- ter String	Pointer
	X	Y	M	T	C	S	D□.b		KnX	KnY	KnM	KnS	T	C	D	R	U□\G□	V	Z	Modify	K	H	E	"□"
(S1•)														✓	✓	✓			✓	✓	✓			
(S2•)														✓	✓	✓			✓	✓	✓			
(D•)														✓	✓	✓			✓					
n																				✓	✓			

2. Program example

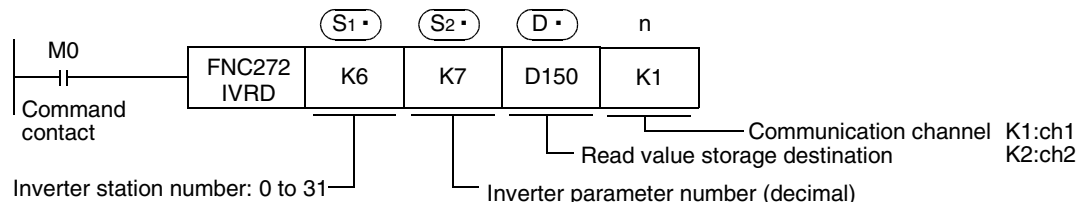

9.6.2 Inverter instruction codes

Refer to related data shown later.

9.6.3 Program example of "second parameter specification code"

→ For second parameter specification code, refer to Section 9.9.

In the program example shown below, the parameter number 201 (frequency: 201, time: 1201, motor rotation direction: 2201) is read from the A500 inverter whose station number is 6.

Read devices: D100 = Motor rotation direction, D101 = Frequency, D102 = Time

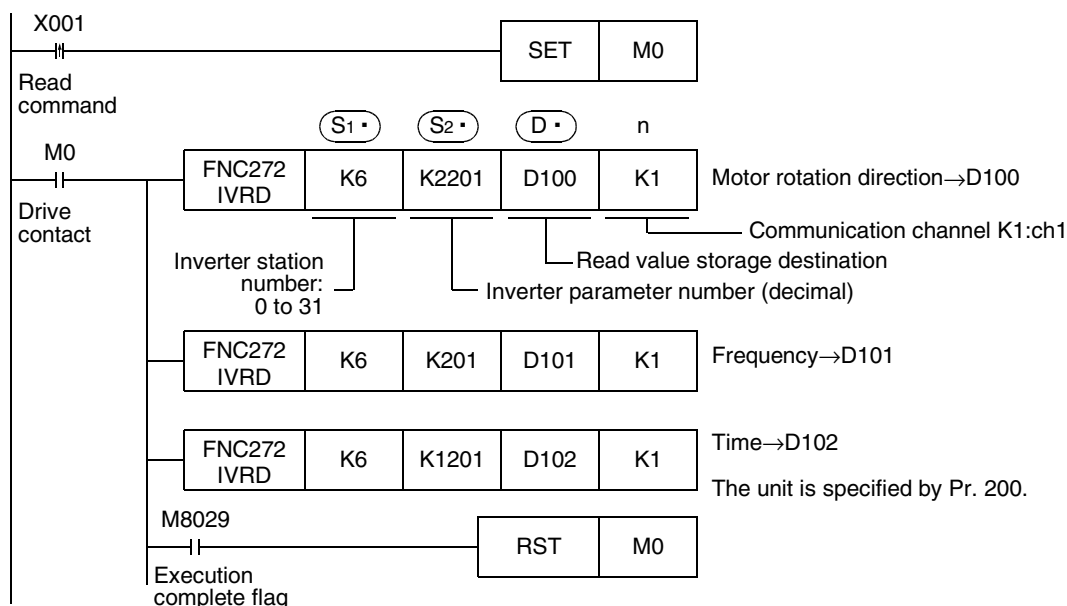

9.7 Inverter Parameter Writing (PLC→Inverter) [FNC273 / IVWR]

This instruction writes a value from the PLC to a parameter in an inverter.

9.7.1 Function and operation

When a parameter number in an inverter is specified in IVWR (FNC273) instruction, the value of (S3•) is written to the specified item in the inverter.

1. Applicable devices

Oper- and Type	Bit Devices							Word Devices										Others						
	System/User							Digit Specification				System/User				Special Unit	Index			Con- stant	Real Number	Charac- ter String	Pointer	
	X	Y	M	T	C	S	D□.b	KnX	KnY	KnM	KnS	T	C	D	R	U□\G□	V	Z	Modify	K	H	E	"□"	P
(S1•)																								
(S2•)																								
(S3•)																								
n																								

2. Program example

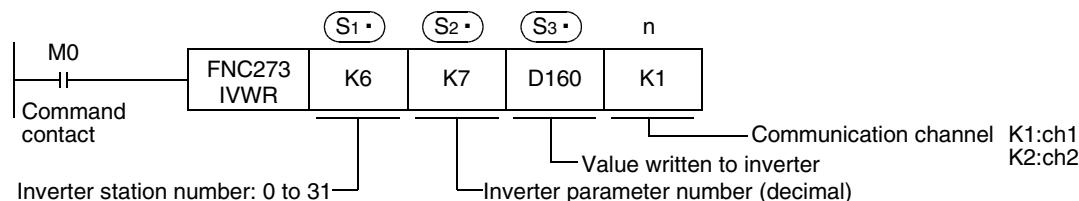

9.7.2 Inverter instruction codes

Refer to related data shown later.

9.7.3 Program example of "second parameter specification code"

→ For second parameter specification code, refer to Section 9.9.

In the program example shown below, data is written from the PLC to the parameter number 201 (frequency: 201, time: 1201, motor rotation direction: 2201) in the A500 inverter.

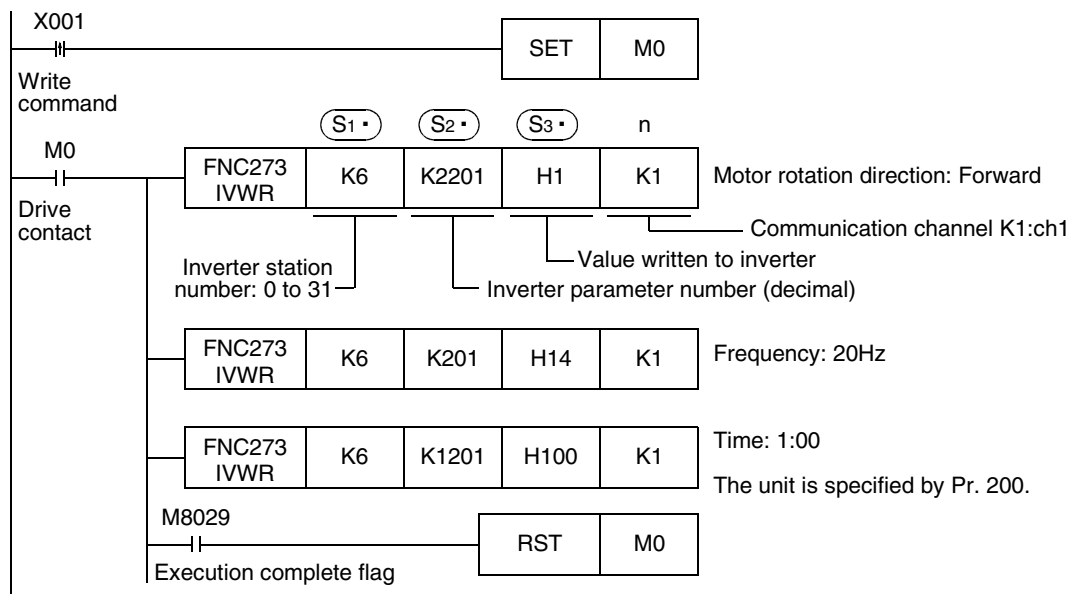

9.8 Inverter Parameter Batch Writing (PLC→Inverter) [FNC274 / IVBWR]

This instruction writes values from the PLC to parameters in an inverter at one time.

9.8.1 Function and operation

When a parameter number in an inverter is specified in IVBWR (FNC274) instruction, the values of (S3•) and later are written to the specified items in the inverter at one time.

1. Applicable devices

Oper- and Type	Bit Devices							Word Devices										Others						
	System/User							Digit Specification				System/User				Special Unit	Index		Con- stant	Real Number	Charac- ter String	Pointer		
	X	Y	M	T	C	S	D□.b	KnX	KnY	KnM	KnS	T	C	D	R	U□\G□	V	Z	Modify	K	H	E	"□"	P
(S1•)																			✓	✓				
(S2•)																			✓	✓				
(S3•)																			✓					
n																				✓	✓			

2. Program example

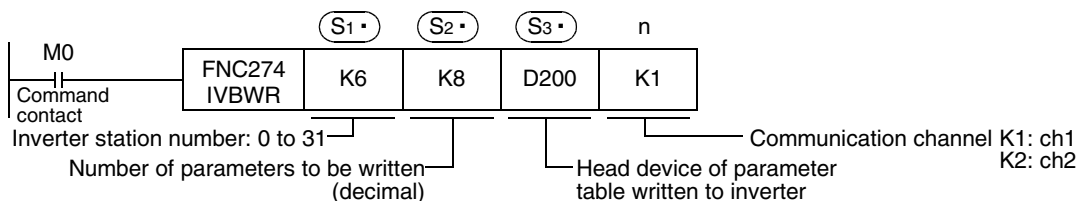

The following table shows values (two word devices/point) in a specified table are written to consecutive parameters whose quantity is specified in (S2•) starting from a word device specified in (S3•).

(S3•)	D200	Parameter No. 1
(S3•) +1	D201	Value 1 written to parameter
(S3•) +2	D202	Parameter No. 2
(S3•) +3	D203	Value 2 written to parameter
⋮	⋮	⋮
(S3•) +14	D214	Parameter No. 8
(S3•) +15	D215	Value 8 written to parameter

(S2•) × 2 = Number of occupied word devices

9.9 Second Parameter Specification Codes

When handling the following parameters in computer link operation, it is necessary to select second parameters.

In IVRD, IVWR, and IVBWR instructions, when a value shown in the tables below is set to (S2) (S3) in IVBWR instruction), the extension parameter and second parameter are automatically overwritten, and then parameter values are read or written.

9.9.1 S500 Series

1. Second parameter specification codes for parameter numbers C2 to C7

Parameter No.	Name	Second parameter specification code		
		[(decimal) value to be specified in (S2) in IVRD/IVWR instruction for parameter number]		
C2	Frequency setting voltage bias frequency	902		
C3	Frequency setting voltage bias	1902		
C4	Frequency setting voltage gain	903		
C5	Frequency setting current bias frequency	904		
C6	Frequency setting current bias	1904		
C7	Frequency setting current gain	905		

9.9.2 E500 Series

1. Second parameter specification codes for parameter numbers 902 to 905

Parameter No.	Name	Second parameter specification code		
		[(decimal) value to be specified in (S2) in IVRD/IVWR instruction for parameter number]		
		Offset/Gain (H00)	Analog (H01)	Analog value of terminal (H02)
902	Frequency setting voltage bias	902	1902	2902
903	Frequency setting voltage gain	903	1903	2903
904	Frequency setting current bias	904	1904	2904
905	Frequency setting current gain	905	1905	2905

A	Common Items
B	N:N Network
C	Parallel Link
D	Computer Link
E	Inverter Communication
F	Non-Protocol Communication (RS/RS2 Instruction)
G	Non-Protocol Communication (FX2N-232IF)
H	Programming Communication
I	Remote Maintenance

9.9.3 A500 Series

1. Second parameter specification codes for parameter numbers 201 to 230 and 902 to 905

Parameter No.	Name	Second parameter specification code [[decimal] value to be specified in (S2) in IVRD/IVWR instruction for parameter number]		
		Operation frequency read/write	Time read/write	Rotation direction write/read
201	Program set 1	201	1201	2201
202	Program set 1	202	1202	2202
203	Program set 1	203	1203	2203
204	Program set 1	204	1204	2204
205	Program set 1	205	1205	2205
206	Program set 1	206	1206	2206
207	Program set 1	207	1207	2207
208	Program set 1	208	1208	2208
209	Program set 1	209	1209	2209
210	Program set 1	210	1210	2210
211	Program set 2	211	1211	2211
212	Program set 2	212	1212	2212
213	Program set 2	213	1213	2213
214	Program set 2	214	1214	2214
215	Program set 2	215	1215	2215
216	Program set 2	216	1216	2216
217	Program set 2	217	1217	2217
218	Program set 2	218	1218	2218
219	Program set 2	219	1219	2219
220	Program set 2	220	1220	2220
221	Program set 3	221	1221	2221
222	Program set 3	222	1222	2222
223	Program set 3	223	1223	2223
224	Program set 3	224	1224	2224
225	Program set 3	225	1225	2225
226	Program set 3	226	1226	2226
227	Program set 3	227	1227	2227
228	Program set 3	228	1228	2228
229	Program set 3	229	1229	2229
230	Program set 3	230	1230	2230

2. Second parameter specification codes for parameter numbers 902 to 905

Parameter No.	Name	Second parameter specification code [[decimal] value to be specified in (S2) in IVRD/IVWR instruction for parameter number]		
		Offset/Gain (H00)	Analog (H01)	Analog value of terminal (H02)
902	Frequency setting voltage bias	902	1902	2902
903	Frequency setting voltage gain	903	1903	2903
904	Frequency setting current bias	904	1904	2904
905	Frequency setting current gain	905	1905	2905

9.9.4 F500 Series

1. Second parameter specification codes for parameter numbers 902 to 905

Parameter No.	Name	Second parameter specification code [(decimal) value to be specified in (S2) in IVRD/ IVWR instruction for parameter number]		
		Offset/Gain (H00)	Analog (H01)	Analog value of terminal (H02)
902	Frequency setting voltage bias	902	1902	2902
903	Frequency setting voltage gain	903	1903	2903
904	Frequency setting current bias	904	1904	2904
905	Frequency setting current gain	905	1905	2905

9.9.5 V500 Series

1. Second parameter specification codes for parameter numbers 902 to 905

Parameter No.	Name	Second parameter specification code [(decimal) value to be specified in (S2) in IVRD/ IVWR instruction for parameter number]		
		Offset/Gain (H00)	Analog (H01)	Analog value of terminal (H02)
902	Speed setting No. 2 bias	902	1902	2902
903	Speed setting No. 2 gain	903	1903	2903
904	Torque command No. 3 bias	904	1904	2904
905	Torque command No. 3 gain	905	1905	2905
917	No.1 terminal bias (speed)	917	1917	2917
918	No.1 terminal gain (speed)	918	1918	2918
919	No.1 terminal bias (torque/magnetic flux)	919	1919	2919
920	No.1 terminal gain (torque/magnetic flux)	920	1920	2920

9.9.6 F700 Series

1. Second parameter specification codes for parameter numbers 125, 126, and C2 to C7

Parameter No.	Name	Second parameter specification code [(decimal) value to be specified in (S2) in IVRD/IVWR instruction for parameter number]
C2	Terminal 2 frequency setting bias frequency	902
C3	Terminal 2 frequency setting bias	1902
125	Terminal 2 frequency setting gain frequency	903
C4	Terminal 2 frequency setting gain	1903
C5	Terminal 4 frequency setting bias frequency	904
C6	Terminal 4 frequency setting bias	1904
126	Terminal 4 frequency setting gain frequency	905
C7	Terminal 4 frequency setting gain	1905

A Common Items
B N:N Network
C Parallel Link
D Computer Link
E Inverter Communication
F Non-Protocol Communication (RS/RS2 Instruction)
G Non-Protocol Communication (FX2N-232IF)
H Programming Communication
I Remote Maintenance

9.9.7 A700 Series

1. Second parameter specification codes for parameter numbers 125, 126, C2 to C7, C12 to C19, and C38 to C41

Parameter No.	Name	Second parameter specification code [(decimal) value to be specified in $\text{S}_{2\bullet}$ in IVRD/IVWR instruction for parameter number]
C2	Terminal 2 frequency setting bias frequency	902
C3	Terminal 2 frequency setting bias	1902
125	Terminal 2 frequency setting gain frequency	903
C4	Terminal 2 frequency setting gain	1903
C5	Terminal 4 frequency setting bias frequency	904
C6	Terminal 4 frequency setting bias	1904
126	Terminal 4 frequency setting gain frequency	905
C7	Terminal 4 frequency setting gain	1905
C12	Bias frequency (speed) for terminal No. 1	917
C13	Bias (speed) for terminal No. 1	1917
C14	Gain frequency (speed) for terminal No. 1	918
C15	Gain (speed) for terminal No. 1	1918
C16	Bias command (torque) for terminal No. 1	919
C17	Bias (torque) for terminal No. 1	1919
C18	Gain command (torque) for terminal No. 1	920
C19	Gain (torque) for terminal No. 1	1920
C38	Bias command (torque) for terminal No. 4	932
C39	Bias (torque) for terminal No. 4	1932
C40	Gain command (torque) for terminal No. 4	933
C41	Gain (torque) for terminal No. 4	1933

10. Practical Program Examples (for FX3U and FX3UC PLCs)

This chapter explains practical programs for inverter communication.

10.1 Practical Example 1

This fundamental program example monitors operations of an inverter, controls operations of an inverter and writes parameters to an inverter.

10.1.1 System configuration example

An FX PLC (ch 1) is connected to an inverter.

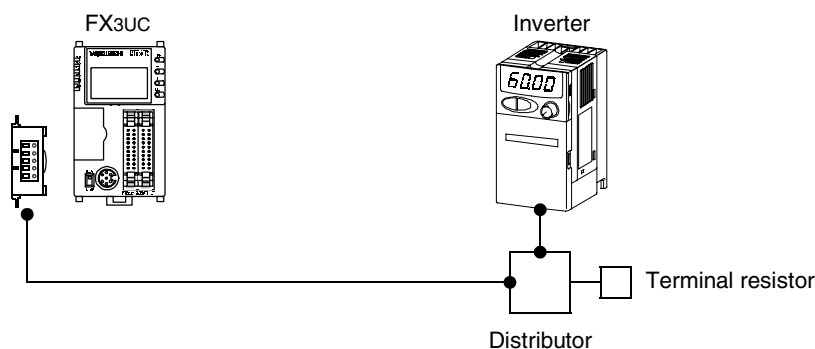

10.1.2 Contents of operation

As an example of operation control, an inverter can be stopped (X000), rotated forward (X001) and rotated reverse (X002).

By changing the contents of D10, the speed can be changed.

The contents of D10 can be changed from a sequence program or display unit.

A

Common Items

B

N:N Network

C

Parallel Link

D

Computer Link

E

Inverter Communication

F

Non-Protocol Communication (RS/RS2 Instruction)

G

Non-Protocol Communication (FX2N-232IF)

H

Programming Communication

I

Remote Maintenance

10.1.3 Program example

1. Writing parameters to an inverter while the PLC is in RUN mode

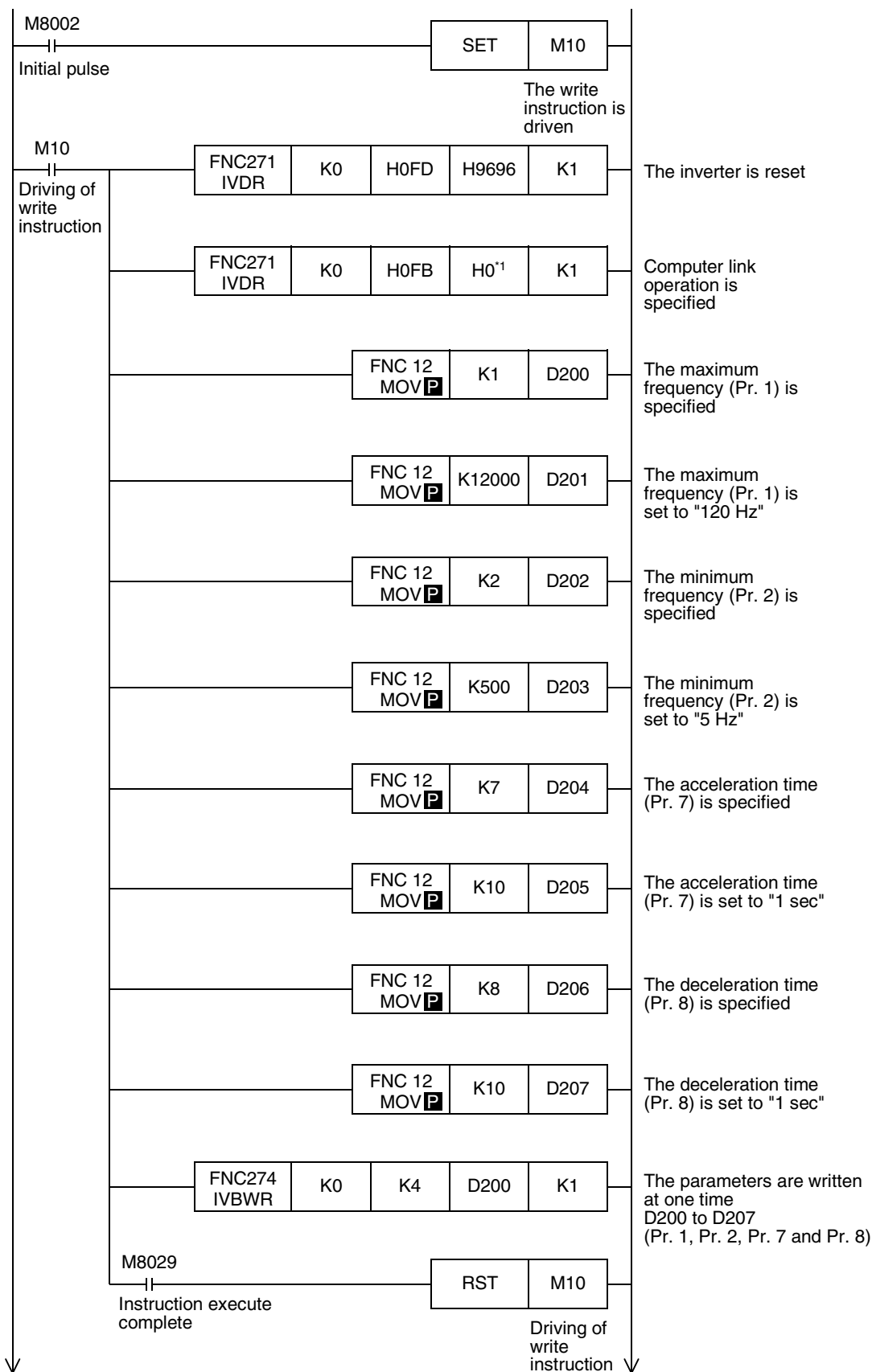

*1. When using an E500 Series inverter, use "H2" to specify computer link operation.

2. Changing the speed using a sequence program

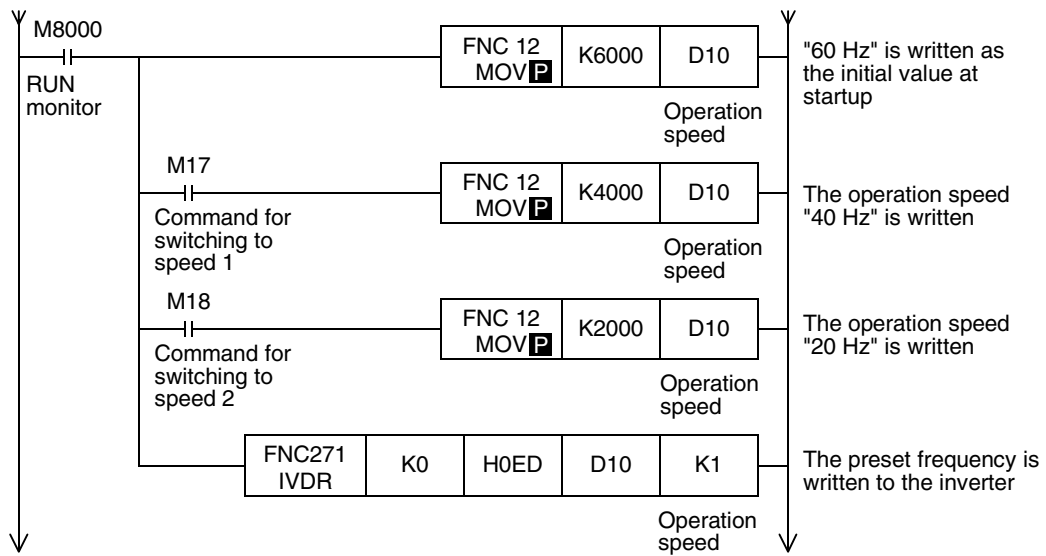

3. Controlling operations of an inverter

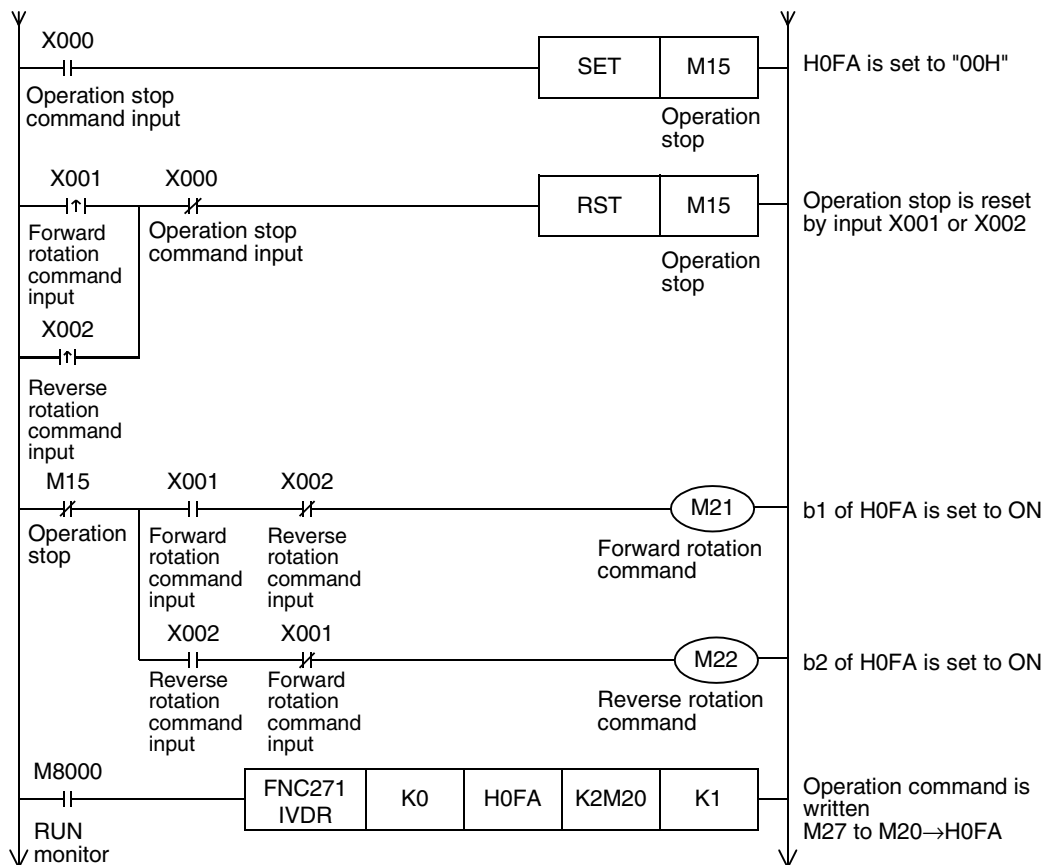

- A** Common Items
- B** N:N Network
- C** Parallel Link
- D** Computer Link
- E** Inverter Communication
- F** Non-Protocol Communication (RS/RS2 Instruction)
- G** Non-Protocol Communication (FX2N-232IF)
- H** Programming Communication
- I** Remote Maintenance

4. Monitoring operations of an inverter

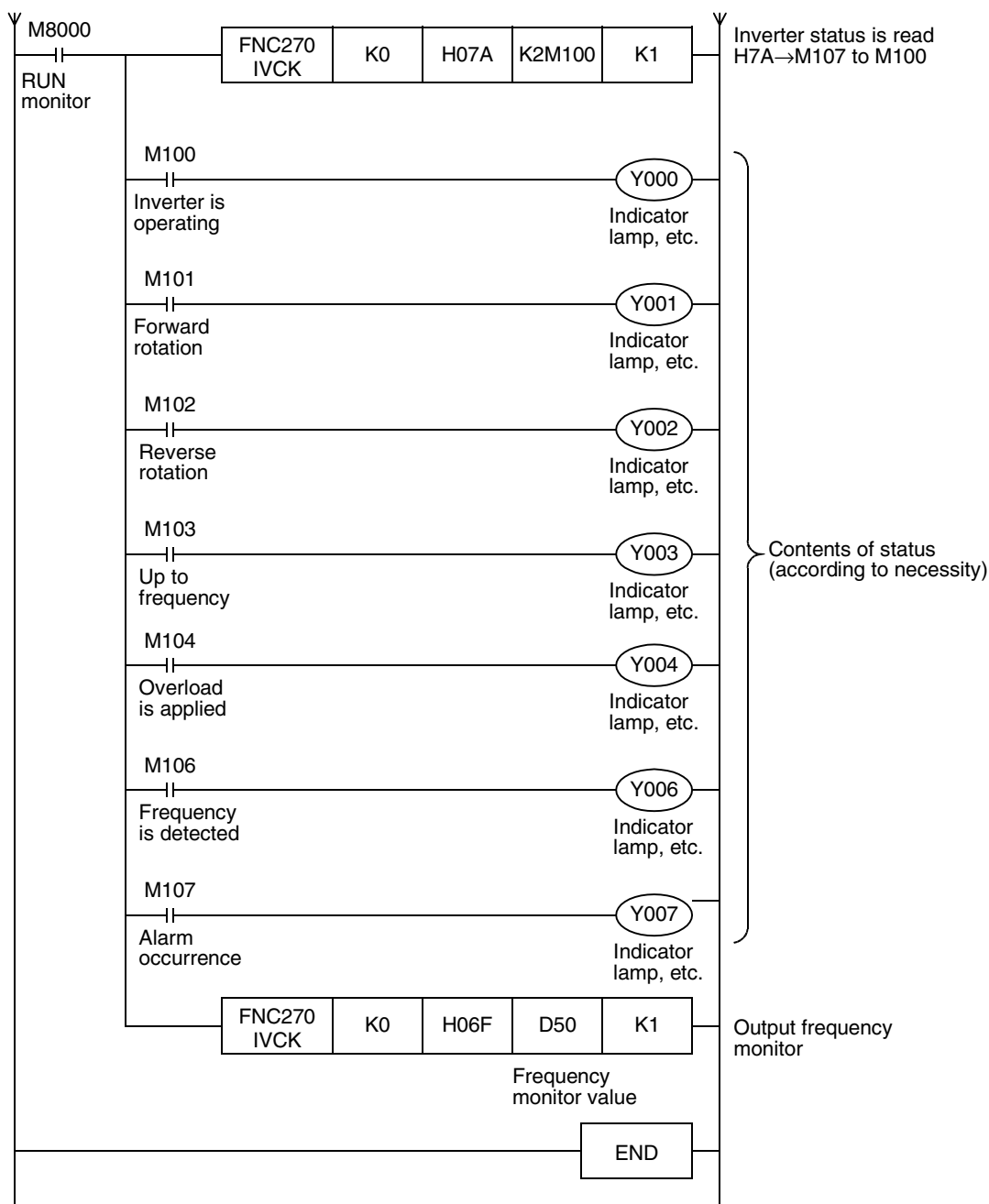

10.2 Practical Example 2

This program executes the same control as the practical example 1 shown above.

10.2.1 System configuration example

An FX PLC (ch 1) is connected to an inverter.

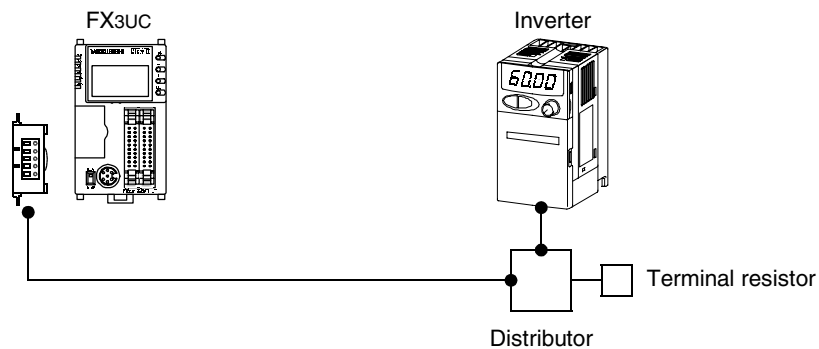

10.2.2 Contents of operation

The differences from practical example 1 are that the inverter status is not read while data is written to an inverter, and that the contents to be written are written to an inverter only when the contents change to be written are detected.

Because communication between the PLC and the inverter is minimum in this program, the communication time is reduced and the response time is improved.

A	Common Items
B	N:N Network
C	Parallel Link
D	Computer Link
E	Inverter Communication
F	Non-Protocol Communication (RS/RS2 Instruction)
G	Non-Protocol Communication (FX2N-232IF)
H	Programming Communication
I	Remote Maintenance

10.2.3 Program example

1. Writing parameters to an inverter while the PLC is in RUN mode

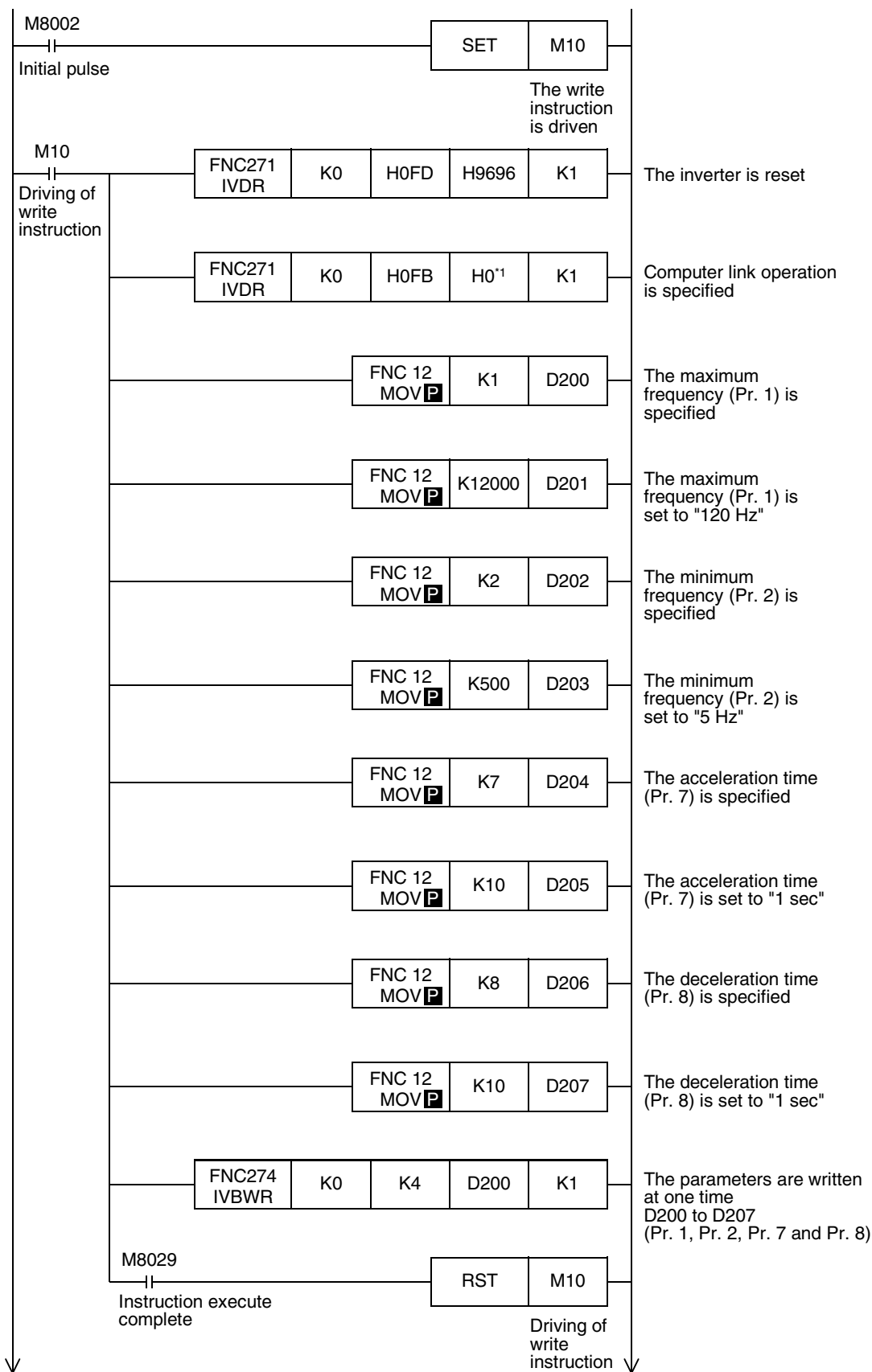

*1. When using an E500 Series inverter, use "H2" to specify computer link operation.

2. Changing the speed using a sequence program

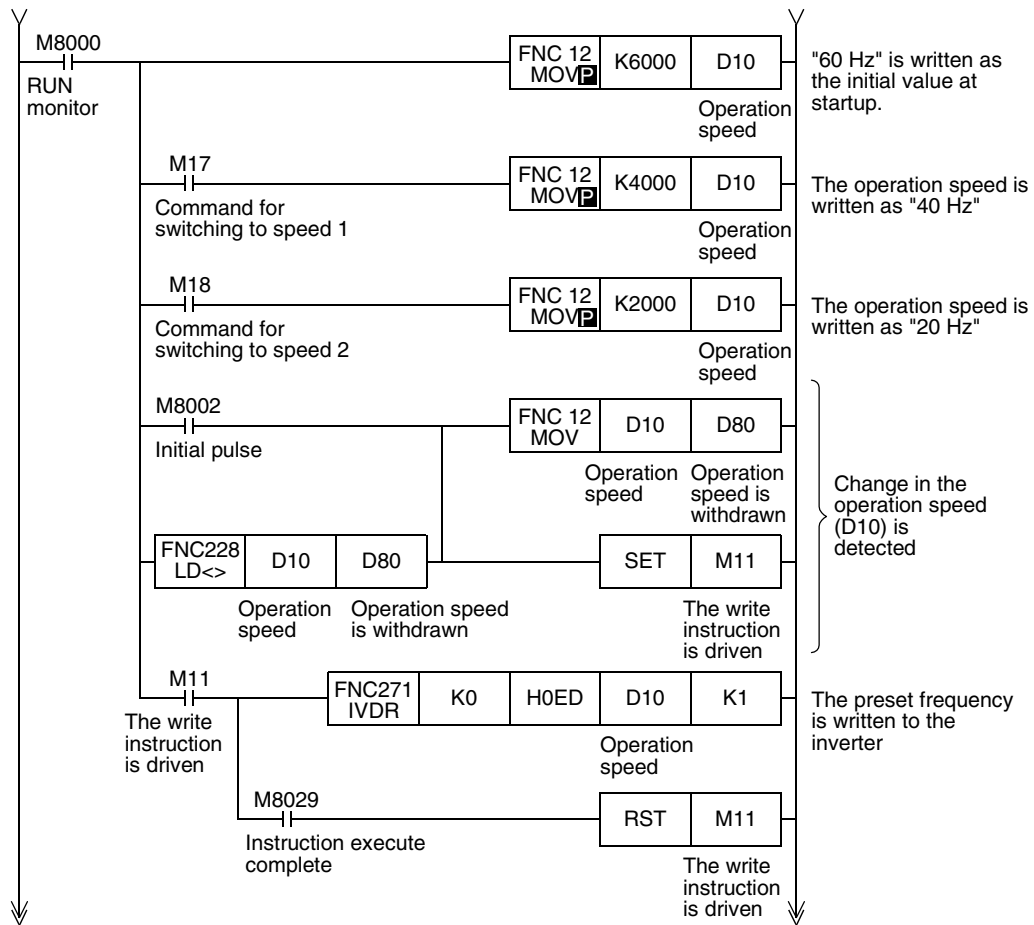

A	Common Items
B	N:N Network
C	Parallel Link
D	Computer Link
E	Inverter Communication
F	Non-Protocol Communication (RS/RS2 Instruction)
G	Non-Protocol Communication (FX2N-232IF)
H	Programming Communication
I	Remote Maintenance

3. Controlling operations of an inverter

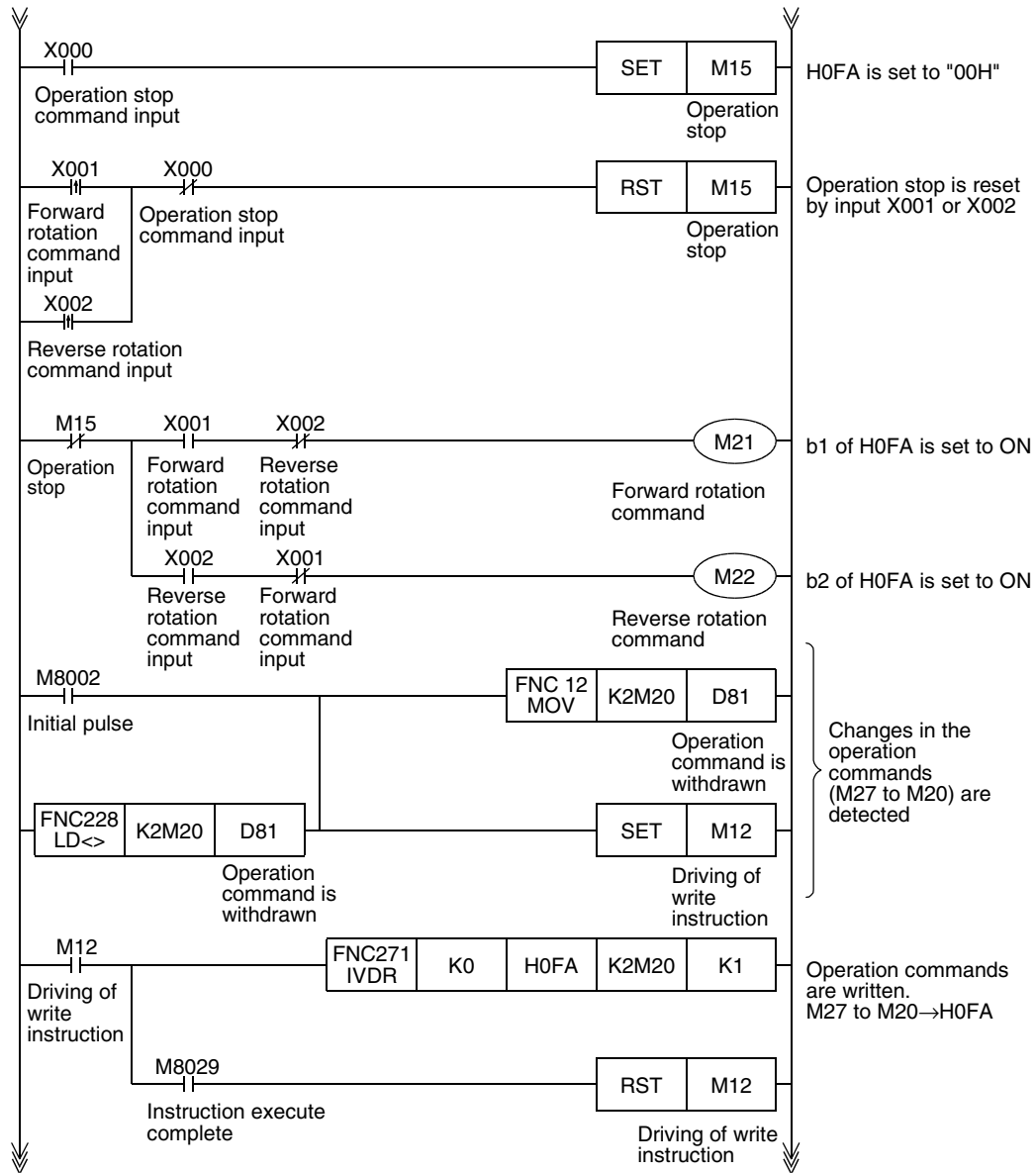

4. Monitoring operations of an inverter

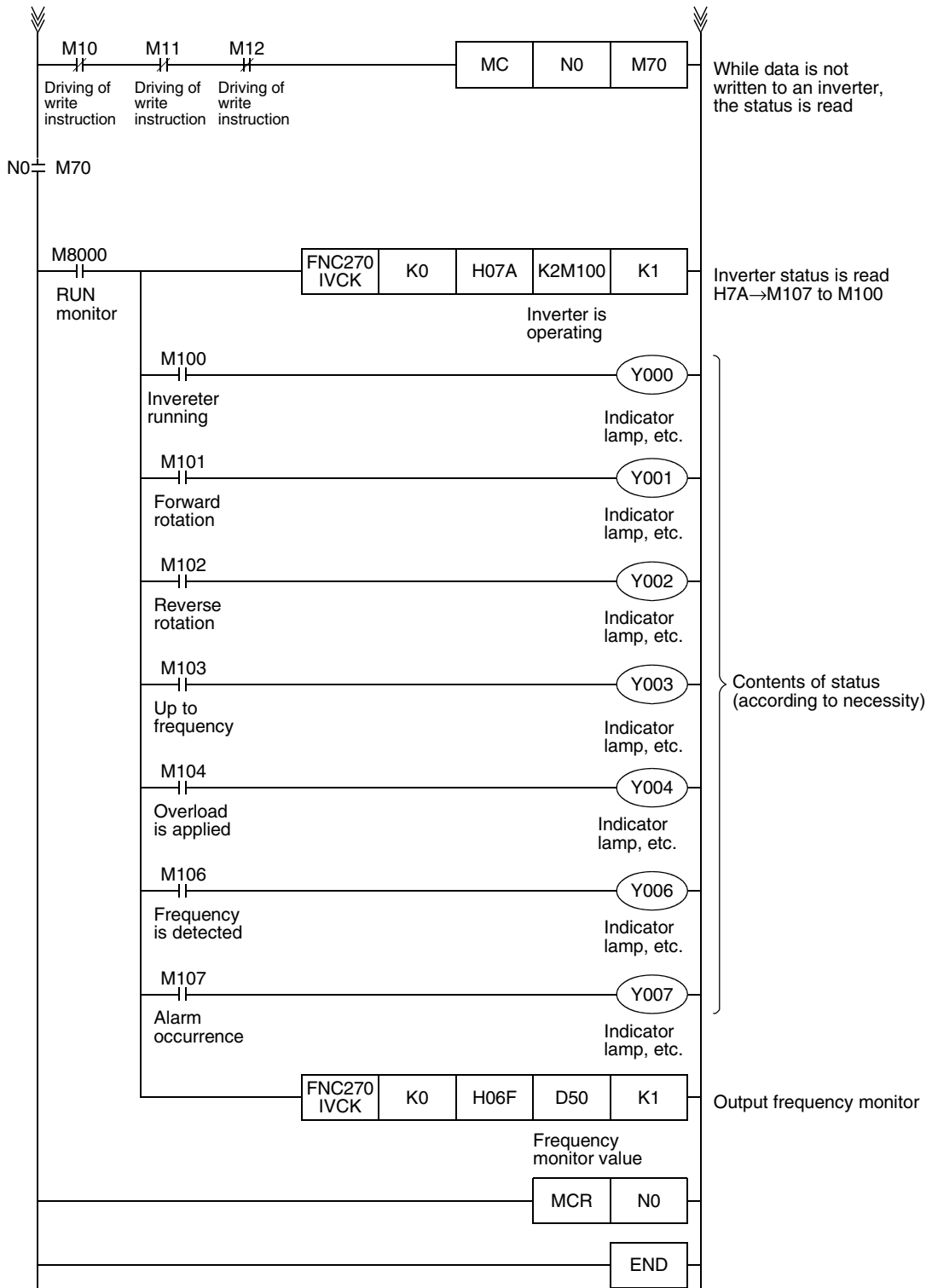

A	Common Items
B	N:N Network
C	Parallel Link
D	Computer Link
E	Inverter Communication
F	Non-Protocol Communication (RS/RS2 Instruction)
G	Non-Protocol Communication (FX2N-232IF)
H	Programming Communication
I	Remote Maintenance

11. Troubleshooting

This chapter explains troubleshooting and error codes.

11.1 Checking FX PLC Version Applicability (FX2N and FX2NC Series)

Verify that the FX PLC main unit is an applicable version for inverter communication.

→ For version applicability, refer to Section 1.3.

11.2 Checking Communication Status Based on LED Indication

Check the status of the "RD(RXD)" and "SD(TXD)" indicator LEDs provided in the optional equipment.

LED status		Operation status
RD	SD	
Flashing	Flashing	Data is being sent or received.
Flashing	Off	Data is received, but is not sent.
Off	Flashing	Data is sent, but is not received
Off	Off	Data is not sent nor received.

11.3 Checking Installation

1. Mounting status

If the communication equipment is not securely connected to the PLC, communication is disabled.

→ For mounting method, refer to the manual of the communication equipment.

2. Power supply (for FX0N-485ADP)

The FX0N-485ADP requires a driving power supply. Verify that the power supply is provided correctly.

3. Wiring

Verify that the wiring to each piece of communication equipment is correct. Incorrect wiring will disable communication.

→ For wiring method check, refer to Chapter 4.

11.4 Checking Sequence Program

1. Communication setting in a sequence program

Verify that N:N Network (D8173 to D8180) and parallel link (M8070 and M8071) are not set.
After changing any setting, make sure to turn OFF the PLC power, and then turn it ON again.

2. Communication setting using parameters

Verify that the communication setting which are using parameters are correct. If the contents of the parameters do not agree, communication will not be correctly.
After changing any parameters, make sure to turn OFF the PLC power, and then turn it ON again.

3. Presence of VRRD and VRSC instructions (in FX2N and FX2NC PLCs)

Verify that VRRD and VRSC instructions are not used in a program.
If these instructions are used, delete them, turn OFF the PLC power, and then turn it ON again.

4. Presence of RS instruction (in FX2N and FX2NC PLCs)

Verify that RS instruction is not used in a program.
If this instruction is used, delete it, turn OFF the PLC power, and then turn it ON again.

5. Presence of RS and RS2 instructions (in FX3U and FX3UC PLCs)

Verify that RS and RS2 instructions are not used in the same channel.
If these instructions are used in the same channel, delete them, turn OFF the PLC power, and then turn it ON again.

11.4.1 Checking inverter operation status

1. When the operation mode of an inverter is not changed over to computer link mode

- 1) Verify that the inverter is set to the external operation mode.
- 2) Verify that no signal is being input to the external terminals STF and STR.
- 3) Verify that a correct operation mode changeover program is executed.

2. When an inverter cannot be started even in computer link mode

- 1) Verify that a program for starting the inverter is executed correctly.
- 2) Verify that the operation command and speed command are set correctly.
- 3) Verify that the allowable communication time interval is set correctly.

3. When an inverter is stopped by alarm during operation due to defective communication

- 1) Verify that a communication cable is connected correctly between the PLC and the inverter.
(Check for poor contact and wire breakage.)
- 2) Verify that a sequence program is created so that communication is executed with each inverter within a constant cycle. Set the communication check time interval to a large value, and check the communication status.
- 3) Verify that the allowable communication time interval is set correctly.
- 4) Verify that terminal resistors are wired correctly.

11.5 Checking Absence/Presence of Errors

Verify that the error flag is not ON.

If the error flag is ON, check the error code and take proper countermeasures.

→ For error codes, refer to the next page.

A

Common Items

B

N:N Network

C

Parallel Link

D

Computer Link

E

Inverter Communication

F

Non-Protocol Communication (RS/RS2 Instruction)

G

Non-Protocol Communication (FX2N-232IF)

H

Programming Communication

I

Remote Maintenance

11.6 Error Codes

When a communication error occurs, the error flag turns ON, and the error code is stored in the data register. For error codes, refer to the table below.

1. Error storing devices

FX Series	Error flag	Data register for storing error code	
FX2N,FX2NC	M8156	D8156	
FX3U,FX3UC	ch1	ch2	
	M8152	M8157	D8152 D8157

2. Error code list

Error code	Contents of error		Inverter operation
0	Normal end	(No Errors)	
1	—	Inverter did not give response.	
2	Timeout error	Sending from inverter was aborted midway.	
3	Station number error	Unspecified station gave response.	
4	Sum check error	The sum of data sent back by the inverter did not match.	
5	Parameter number specification error	In writing or reading a parameter, an improper parameter number was specified. At this time, error code (K6706) is set to D8067. K6706: Out-of-range data value for operand in applied instruction.	
6	Communication port occupied by another communication	Because the port is being used for another communication, it cannot be used for communication with the inverter. At this time, error code (K6762) is set to D8067. K6762: The port specified in inverter communication instruction is used in another communication.	
256	Computer NAK error	Inverter sent the error code H0. The number of retries exceeds the allowable number because of an error in the transfer request data.	When errors have occurred consecutively beyond the allowable number of retries, inverter is brought to an alarm stop.
257	Parity error	Inverter sent the error code H1. The contents are different from the specified parity.	
258	Sum check error	Inverter sent the error code H2. The sum check code in the computer is different from the sum value calculated from the data received by the inverter.	
259	Protocol error	Inverter sent the error code H3. Syntax error is included in the data received by inverter, receiving of data was not completed within the specified time, or CR/LF does not agree with the parameters.	
260	Framing error	Inverter sent the error code H4. The stop bit length is different from the initial set value.	
261	Overrun error	Inverter sent the error code H5. Before receiving the completed data in the inverter, the computer sent the next set of data.	
262	Undefined	Inverter sent the error code H6. Not defined currently in inverter.	
263	Character error	Inverter sent the error code H7. An unused character (other than 0 to 9, A to F and control codes) is received.	Inverter does not accept received data, but is not brought to an alarm stop.
264	Undefined	Inverter sent the error code H8. Not defined currently in inverter.	
265	Undefined	Inverter sent the error code H9. Not defined currently in inverter.	

Error code	Contents of error		Inverter operation
266	Mode error	Inverter sent the error code HA. A parameter was written in a mode other than computer link mode, or while the inverter was operating.	Inverter does not accept received data, but is not brought to an alarm stop.
267	Instruction code error	Inverter sent the error code HB. Non-existing instruction code was specified.	
268	Data range error	Inverter sent the error code HC. In writing a parameter or operation frequency, data outside the allowable range was specified.	
269	Undefined	Inverter sent the error code HD. Not defined currently in inverter.	
270	Undefined	Inverter sent the error code HE. Not defined currently in inverter.	
271	Undefined	Inverter sent the error code HF. Not defined currently in inverter.	

A

Common Items

B

N:N Network

C

Parallel Link

D

Computer Link

E

Inverter Communication

F

Non-Protocol Communication (RS/RS2 Instruction)

G

Non-Protocol Communication (FX2N-232IF)

H

Programming Communication

I

Remote Maintenance

12. Related Data

This chapter shows various technical information.

12.1 Related Device List for FX2N and FX2NC PLCs

The tables below show special auxiliary relays and special data registers used in inverter communication (EXTR K10 to EXTR K13).

1. Bit devices

Device No.	Name	Description	R/W
M8029	Instruction execution complete	Turns ON when execution of EXTR instruction is completed, and remains ON for 1 scan. Turns ON also when execution of instruction is completed if M8156 (communication error or parameter error) turns ON.	R
M8104	Extension ROM cassette check	Remains ON while an extension ROM cassette is attached.	R
M8154	Unused	—	R
M8155	Communication port busy	Remains ON while the communication port is used by an EXTR instruction.	R
M8156	Communication error or parameter error	Turns ON when a communication error is caused by an EXTR instruction.	R
M8157	Communication error latch ^{*1}	Turns ON when a communication error is caused by an EXTR instruction.	R

R: For reading only (used as a contact in program)

*1. Cleared when the PLC mode is changed from STOP to RUN.

2. Word devices

Device No.	Name	Description	R/W
D8104	Extension ROM cassette type code	Stores the type code of an extension ROM cassette (value: K1).	R
D8105	Extension ROM cassette version	Stores the version of an extension ROM cassette (value: K100 = Ver. 1.00).	R
D8154	Inverter response waiting time	Sets the inverter response waiting time.	R/W
D8155	Step number of instruction using communication port	Stores the step number of EXTR instruction using the communication port.	R
D8156	Error code ^{*1}	Stores an error code when a communication error is caused by an EXTR instruction.	R
D8157	Error occurrence step number latch ^{*1}	Stores an instruction step number in which a communication error has occurred. (Stores K-1 when no error has occurred.)	R

R: For reading only

W: For writing only

*1. Cleared when the PLC mode is changed from STOP to RUN.

12.2 Details of Related Devices for FX2N and FX2NC PLCs

The following devices are special devices used in inverter communication.

12.2.1 Instruction execution complete [M8029]

When execution of an inverter communication instruction is completed, this device turns ON.

1. Detailed contents

When execution of an inverter communication instruction is completed, M8029 turns ON, and remains ON for 1 scan.

When an error occurs in an inverter communication instruction, M8029 turns ON.

2. Cautions on use

M8029 is used as the execution complete flag for other instructions (such as positioning instructions).

When using M8029, provide the contact just under an instruction whose execution completion is to be checked.

12.2.2 Extension ROM cassette check [M8104]

This device remains ON while an extension ROM cassette is attached.

1. Detailed contents

M8104 remains ON while an extension ROM cassette is attached.

- FX2N FX2N-ROM-E1
- FX2NC FX2NC-ROM-CE1

2. Cautions on use

While M8104 is OFF, EXTR instructions cannot be used.

12.2.3 Communication port busy [M8155]

This device remains ON while the communication port is being used by an EXTR instruction.

1. Detailed contents

M8155 remains ON while communication with an inverter is executed by an EXTR instruction.

When M8155 turns ON, D8155 stores the step number of an instruction using the communication port.

While M8155 is ON, another EXTR instruction cannot be executed.

12.2.4 Communication error or parameter error [M8156]

This device turns ON when an error is caused in communication with an inverter by an EXTR instruction.

1. Detailed contents

M8156 turns ON when an error is caused in communication with an inverter by an EXTR instruction.

When M8156 turns ON, D8156 stores the error code.

2. Cautions on use

M8156 is set to OFF by an EXTR instruction located in the next step in the program.

When using M8156, provide it just under EXTR instruction whose error is to be checked.

A	Common Items
B	N:N Network
C	Parallel Link
D	Computer Link
E	Inverter Communication
F	Non-Protocol Communication (RS/RS2 Instruction)
G	Non-Protocol Communication (FX2N-232IF)
H	Programming Communication
I	Remote Maintenance

12.2.5 Communication error latch [M8157]

This device turns ON when the communication error flag M8156 turns ON.

1. Detailed contents

M8157 turns ON when a communication error occurs and M8156 turns ON.
When M8157 turns ON, D8157 stores the step number in which the error has occurred.

2. Cautions on use

M8157 remains ON until the PLC mode is changed from STOP to RUN.

12.2.6 Extension ROM cassette type code [D8104]

This device stores the type code of an extension ROM cassette.

1. Detailed contents

While the following ROM is attached in an FX PLC, D8104 stores its model code.

- FX2N FX2N-ROM-E1 (model code: K1)
- FX2NC FX2NC-ROM-CE1 (model code: K1)

12.2.7 Extension ROM cassette version [D8105]

This device stores the version of an extension ROM cassette.

1. Detailed contents

While an extension ROM is attached, D8105 stores its version information (K100 = Ver. 1.00).

12.2.8 Inverter response waiting time [D8154]

This device sets the response waiting time of an inverter.

1. Detailed contents

D8154 sets the response waiting time of an inverter.
Set a value within the range from "1 to 32767" (unit: 100 ms) to D8154.
When "0" or a negative value is set, it is handled as "100 ms".

12.2.9 Step number of instruction using communication port [D8155]

This device stores the step number of an instruction occupying the communication port.

1. Detailed contents

D8155 stores the step number of EXTR instruction using the communication port.

12.2.10 Error code [D8156]

This device stores an error code when an error is caused in communication with an inverter by an EXTR instruction.

1. Detailed contents

D8156 stores one of the following error codes when an error is caused in communication with an inverter by an EXTR instruction.

Error code	Contents of error	Inverter operation	
0	Normal end (no error)		
1	Inverter did not give response.		
2	Timeout error. This code interlocks with M8156. Sending from inverter was aborted midway through.		
3	An unspecified station gave response.		
4	The sum of data sent back by the inverter did not match.		
5	In writing or reading a parameter, a improper parameter number was specified. At this time, the error code K6702 is set to D8067.		
6	Because the port is being used for another communication, it cannot be used for communication with the inverter. At this time, the error code K6762 is set to D8067.		
256	Inverter sent the error code H0. Computer NAK error. An error was included in the transfer request data from the computer beyond the allowable number of retries.	When errors have occurred consecutively beyond the allowable number of retries, inverter is brought to an alarm stop.	
257	Inverter sent the error code H1. Parity error. The contents are different from the specified parity.		
258	Inverter sent the error code H2. Sum check error. The sum check code in the computer is different from the sum value calculated from the data received by inverter.		
259	Inverter sent the error code H3. Protocol error. Syntax error is included in the data received by the inverter, and the receiving of data has not been completed within the specified time, or CR/LF does not agree with the parameters.		
260	Inverter sent the error code H4. Framing error. The stop bit length is different from the initial set value.		
261	Inverter sent the error code H5. Overrun error. Before receiving the completed data in the inverter, the computer sent the next set of data.		
262	Inverter sent the error code H6. Not defined currently in inverter.		
263	Inverter sent the error code H7. Character error. An unused character (other than 0 to 9, A to F and control codes) is received.		Inverter does not accept the received data, but is not brought to an alarm stop.
264	Inverter sent the error code H8. Not defined currently in inverter.		
265	Inverter sent the error code H9. Not defined currently in inverter.		

A	Common Items
B	N:N Network
C	Parallel Link
D	Computer Link
E	Inverter Communication
F	Non-Protocol Communication (RS/RS2 Instruction)
G	Non-Protocol Communication (FX2N-232IF)
H	Programming Communication
I	Remote Maintenance

Error code	Contents of error	Inverter operation
266	Inverter sent the error code HA. Mode error. A parameter was written in a mode other than computer link mode, or while inverter was operating. Inverter does not accept the received data, but is not stopped by alarm.	Inverter does not accept the received data, but is not brought to an alarm stop.
267	Inverter sent the error code HB. Instruction code error. Non-existing instruction code was specified.	
268	Inverter sent the error code HC. Data range error. In writing a parameter or operation frequency, data outside the allowable range was specified. Inverter does not accept the received data, but is not stopped by alarm.	
269	Inverter sent the error code HD. Not defined currently in inverter.	
270	Inverter sent the error code HE. Not defined currently in inverter.	
271	Inverter sent the error code HF. Not defined currently in inverter.	

12.2.11 Error occurrence step number latch [D8157]

This device stores the step number in which the communication error has occurred.

1. Detailed contents

When M8157 turns ON, D8157 stores the step number in which communication error has occurred.

When errors have occurred in two or more instructions, D8157 holds the step number of the instruction in which an error occurred first.

When no error has occurred, D8157 stores "-1".

12.3 Related Device List for FX3U and FX3UC PLCs

The tables below show special auxiliary relays and special data registers used in inverter communication (FNC270 (IVCK) to FNC274 (IVBWR)).

1. Bit devices

Device No.		Name	Description	R/W
ch1	ch2			
M8029		Instruction execution complete	Turns ON when the execution of inverter communication instruction is completed, and remains ON for 1 scan. Turns ON also when the execution of instruction is completed if inverter communication error flag (M8152 or M8157) turns ON.	R
M8063	M8438	Serial communication error* ¹	Turns ON when an error occurs in any type of communication.	R
M8151	M8156	Inverter communicating	Remains ON while inverter communication is being executed.	R
M8152	M8157	Inverter communication error* ¹	Turns ON when an error occurs during communication with an inverter.	R
M8153	M8158	Inverter communication error latch* ¹	Turns ON when an error occurs during communication with an inverter.	R
M8154	M8159	IVBWR instruction error* ¹	Turns ON when an error is caused by IVBWR instruction.	R

R: For reading only (used as a contact in program)

*1. Cleared when the PLC mode is changed from STOP to RUN.

2. Word devices

Device No.		Name	Description	R/W
ch1	ch2			
D8063	D8438	Error code for serial communication* ¹	Stores a communication error code.	R
D8150	D8155	Inverter communication response waiting time	Sets the response waiting time for inverter communication.	R/W
D8151	D8156	Step number of instruction executing inverter communication	Stores the step number of an instruction executing inverter communication.	R
D8152	D8157	Error code for inverter communication* ¹	Stores an inverter communication error code.* ²	R
D8153	D8158	Inverter communication error occurring step latch* ¹	Latches a step number in which an inverter communication error has occurred.* ²	R
D8154	D8159	Error parameter number of IVBWR instruction* ¹	Stores a parameter number in which an IVBWR instruction error has occurred.	R

R: For reading only

W: For writing only

*1. Cleared when the PLC mode is changed from STOP to RUN.

*2. Updated only for the first error occurrence, and not for the second error occurrence or later.

A Common Items
B N:N Network
C Parallel Link
D Computer Link
E Inverter Communication
F Non-Protocol Communication (RS/R52 Instruction)
G Non-Protocol Communication (FX2N-232IF)
H Programming Communication
I Remote Maintenance

12.4 Details of Related Devices for FX3U and FX3UC PLCs

The following devices are special devices used in inverter communications.

12.4.1 Instruction execution complete [M8029]

When execution of an inverter communication instruction is completed, this device turns ON.

1. Detailed contents

When execution of an inverter communication instruction is completed, M8029 turns ON, and remains ON for 1 scan.

When an error occurs in an inverter communication instruction, M8029 turns ON, and remains ON for 1 scan in the same way.

2. Cautions on use

M8029 is used as the execution complete flag for other instructions (such as positioning instructions).

When using M8029, provide the contact just under an instruction whose execution completion is to be checked.

12.4.2 Serial communication error [M8063 and M8438]

These devices turn ON when an error occurs during communication with an inverter.

1. Detailed contents

M8063 or M8438 turns ON when a parity error, overrun error or framing error occurs during communication with inverters or when an inverter communication error occurs.

M8063 turns ON when an error occurs during communication using the ch 1. When M8063 turns ON, D8063 stores the error code.

M8438 turns ON when an error occurs during communication using the ch 2. When M8438 turns ON, D8438 stores the error code.

2. Cautions on use

M8063 and M8438 do not turn OFF even if the communication recovers its normal status. Clear them by changing the PLC mode from STOP to RUN.

12.4.3 Inverter communication ON [M8151 and M8156]

These devices remain ON while the communication port is used by an inverter communication instruction.

1. Detailed contents

M8151 or M8156 remains ON while communication with an inverter is executed by an inverter communication instruction.

M8151 remains ON while the communication port (ch 1) is used. While M8151 remains ON, D8151 stores the step number of an instruction using the communication port.

M8156 remains ON while the communication port (ch 2) is used. While M8156 remains ON, D8156 stores the step number of an instruction using the communication port.

2. Cautions on use

While M8151 or M8156 remains ON, another inverter communication instruction cannot be executed.

A	Common Items
B	N:N Network
C	Parallel Link
D	Computer Link
E	Inverter Communication
F	Non-Protocol Communication (RS/RS2 Instruction)
G	Non-Protocol Communication (FX2N-232IF)
H	Programming Communication
I	Remote Maintenance

12.4.4 Inverter communication error [M8152, M8153, M8157 and M8158]

These devices turn ON when an error occurs in an inverter communication instruction.

1. Detailed contents

M8152 or M8157 turn ON when an error occurs in an inverter communication instruction.

M8152 turn ON when an error occurs during communication using the communication port (ch 1). When M8152 turn ON, D8152 stores the error code and D8153 stores the error step number.(M8153 is an error latch.)

M8157 turn ON when an error occurs during communication using the communication port (ch 2). When M8157 turn ON, D8157 stores the error code and D8158 stores the error step number.(M8158 is an error latch.)

Storing to D8152, D8153, D8157 and D8158 are updated only for the first error occurrence, and not for the second error occurrence or later.

2. Cautions on use

M8152 and M8157 do not turn OFF even if the communication recovers its normal status. Clear them by changing the PLC mode from STOP to RUN.

12.4.5 IVBWR instruction error [M8154 and M8159]

These devices turn ON when an error occurs in IVBWR instruction.

1. Detailed contents

M8154 or M8159 turns ON when a parameter number of set value specified in IVBWR instruction is outside the allowable range.

M8154 turns ON when an error occurs in IVBWR instruction using the communication port (ch 1). When M8154 turns ON, D8154 stores the rejected parameter number.

M8159 turns ON when an error occurs in IVBWR instruction using the communication port (ch 2). When M8159 turns ON, D8159 stores the rejected parameter number.

2. Cautions on use

M8154 and M8159 do not turn OFF even if the communication recovers its normal status. Clear them by changing the PLC mode from STOP to RUN.

12.4.6 Serial communication error code [D8063 and D8438]

These devices store an error code when the serial communication error flag turns ON.

1. Detailed contents

When an error occurs in an inverter communication instruction, D8063 or D8438 stores either of the following error codes.

Error code		Contents
ch1	ch2	
D8063	D8438	
6301	3801	Parity error, framing error or overrun error
6320	3820	Inverter communication error

2. Cautions on use

D8063 and D8438 do not turn OFF even if the communication recovers its normal status. Clear them by changing the PLC mode from STOP to RUN.

12.4.7 Inverter response waiting time [D8150 and D8155]

These devices set the response waiting time of an inverter.

1. Detailed contents

Set the response waiting time of an inverter.

When using the communication port (ch 1), set a value to D8150.

When using the communication port (ch 2), set a value to D8155.

Set a value within the range from "1 to 32767" (unit: 100 ms).
 If "0" or negative value is set, it is handled as "100 ms".

12.4.8 Step number of instruction using communication port [D8151 and D8156]

These devices store the step number of an instruction occupying the communication port.

1. Detailed contents.

D8151 or D8156 stores the step number of an inverter communication instruction using the communication port.

D8151 stores the step number using the communication port (ch 1).

D8156 stores the step number using the communication port (ch 2).

2. Cautions on use

A decimal value without sign is stored as the step number in D8151 and D8156.

12.4.9 Inverter communication error code [D8152 and D8157]

These devices store an error code when a communication error is caused by an inverter communication instruction.

1. Detailed contents

Special data registers shown below respectively store inverter communication errors, depending on each communication port.

- D8152 stores the error code of an error in communication using the communication port (ch 1).
- D8157 stores the error code of an error in communication using the communication port (ch 2).

2. Error codes

Following error codes are stored.

Error code	Contents of error	Inverter operation
0	Normal end (no error)	
1	Inverter did not give response.	
2	Timeout error. This code interlocks with M8156. Sending from inverter was aborted midway through.	
3	An unspecified station gave response.	
4	The sum of data sent back by inverter did not match.	
5	In writing or reading a parameter, improper parameter number was specified. At this time, the error code K6702 is set to D8067.	
6	Because the port is being used for another communication, it cannot be used for communication with the inverter. At this time, the error code K6762 is set to D8067.	

Error code	Contents of error	Inverter operation
256	Inverter sent the error code H0. Computer NAK error. An error was included in the transfer request data from the computer beyond the allowable number of retries.	When errors have occurred consecutively beyond the allowable number of retries, inverter is brought to an alarm stop.
257	Inverter sent the error code H1. Parity error. The contents are different from the specified parity.	
258	Inverter sent the error code H2. Sum check error. The sum check code in the computer is different from the sum value calculated from the data received by the inverter.	
259	Inverter sent the error code H3. Protocol error. Syntax error is included in the data received by the inverter, and the receiving of data was not completed within the specified time, or CR/LF does not agree with the parameters.	
260	Inverter sent the error code H4. Framing error. The stop bit length is different from the initial set value.	
261	Inverter sent the error code H5. Overrun error. Before receiving the completed data in the inverter, the computer sent the next set of data.	
262	Inverter sent the error code H6. Not defined currently in inverter.	Inverter does not accept the received data, but is not brought to an alarm stop.
263	Inverter sent the error code H7. Character error. An unused character (other than 0 to 9, A to F and control codes) is received.	
264	Inverter sent the error code H8. Not defined currently in inverter.	
265	Inverter sent the error code H9. Not defined currently in inverter.	
266	Inverter sent the error code HA. Mode error. A parameter was written in a mode other than computer link mode or while inverter was operating. Inverter does not accept the received data, but is not stopped by alarm.	Inverter does not accept the received data, but is not brought to an alarm stop.
267	Inverter sent the error code HB. Instruction code error. Non-existing instruction code was specified.	
268	Inverter sent the error code HC. Data range error. In writing a parameter or operation frequency, data outside the allowable range was specified. Inverter does not accept the received data, but is not stopped by alarm.	
269	Inverter sent the error code HD. Not defined currently in inverter.	
270	Inverter sent the error code HE. Not defined currently in inverter.	
271	Inverter sent the error code HF. Not defined currently in inverter.	

12.4.10 Inverter communication error occurrence step [D8153 and D8158]

These devices store the step number in which an inverter communication error has occurred.

1. Detailed contents

D8153 or D8158 stores the step number of an instruction causing an inverter communication error.
 D8153 stores the step number in which an error has occurred in communication using the communication port (ch 1).
 D8158 stores the step number in which an error has occurred in communication using the communication port (ch 2).
 When errors that occurred in two or more instructions, D8153 or D8158 holds the step number in which the error occurred first.
 When no error has occurred, D8153 or D8158 stores "-1".

2. Cautions on use

A decimal value without the sign is stored as the step number in D8153 and D8158.

A	Common Items
B	N:N Network
C	Parallel Link
D	Computer Link
E	Inverter Communication
F	Non-Protocol Communication (RS/RS2 Instruction)
G	Non-Protocol Communication (FX2N-232IF)
H	Programming Communication
I	Remote Maintenance

12.4.11 IVBWR instruction error parameter number [D8154 and D8159]

These devices store the parameter number in which an error has occurred when IVBWR instruction error flag "M8154 or M8159" turns ON.

1. Detailed contents

D8154 or D8159 stores the parameter number which was not written by IVBWR instruction.

D8154 stores the parameter number which was not written in communication using the communication port (ch 1).

D8159 stores the parameter number which was not written in communication using the communication port (ch 2).

When errors that occurred in two or more IVBWR instructions, D8154 or D8159 holds the parameter number in which the error occurred first.

12.5 FREQROL Inverter Parameter List

This section shows the list of parameters provided in FREQROL F700, A700, V500, F500, A500, E500 and S500 Series inverters.

For details on each function, refer to the manual of each inverter.

12.5.1 Parameters in V500, F500, A500, E500, and S500 Series

The following parameters are provided in FREQROL inverters. (For details, make sure to refer to the manual of each inverter.)

Function	FREQROL V500 Series		FREQROL F500 Series		FREQROL A500 Series		FREQROL E500 Series		FREQROL S500 Series	
	Pr No.	Name	Pr No.	Name	Pr No.	Name	Pr No.	Name	Pr No.	Name
Basic functions	0	Torque boost (manual)	0	Torque boost	0	Torque boost ^{*3}	0	Torque boost ^{*3}	0	Torque boost ^{*3}
	1	Maximum speed (simple mode)	1	Maximum frequency	1	Maximum frequency	1	Maximum frequency	1	Maximum frequency
	2	Minimum speed (simple mode)	2	Minimum frequency	2	Minimum frequency	2	Minimum frequency	2	Minimum frequency
	3	Base frequency	3	Base frequency	3	Base frequency	3	Base frequency ^{*3}	3	Base frequency ^{*3}
	4	Multi-speed setting (high speed) (simple mode)	4	Multi-speed setting (high speed)	4	Multi-speed setting (high speed)	4	Multi-speed setting (high speed)	4	Multi-speed setting (high speed)
	5	Multi-speed setting (middle speed) (simple mode)	5	Multi-speed setting (middle speed)	5	Multi-speed setting (middle speed)	5	Multi-speed setting (middle speed)	5	Multi-speed setting (middle speed)
	6	Multi-speed setting (low speed) (simple mode)	6	Multi-speed setting (low speed)	6	Multi-speed setting (low speed)	6	Multi-speed setting (low speed)	6	Multi-speed setting (low speed)
	7	Acceleration time (simple mode)	7	Acceleration time	7	Acceleration time	7	Acceleration time	7	Acceleration time
	8	Deceleration time (simple mode)	8	Deceleration time	8	Deceleration time	8	Deceleration time	8	Deceleration time
	9	Electronic thermal O/L relay	9	Electronic thermal O/L relay	9	Electronic thermal O/L relay	9	Electronic thermal O/L relay	9	Electronic thermal O/L relay
Standard operation functions	10	DC injection brake operation speed	10	DC injection brake operation frequency	10	DC injection brake operation frequency	10	DC injection brake operation frequency	10	DC injection brake operation frequency
	11	DC injection brake operation time	11	DC injection brake operation time	11	DC injection brake operation time	11	DC injection brake operation time	11	DC injection brake operation time
	12	DC injection brake voltage	12	DC injection brake voltage	12	DC injection brake voltage	12	DC injection brake voltage	12	DC injection brake voltage
	13	Starting speed	13	Starting frequency	13	Starting frequency	13	Starting frequency	13	Starting frequency
	—	—	14	Load pattern selection	14	Load pattern selection ^{*3}	14	Load pattern selection ^{*3}	14	Load pattern selection ^{*3}
	15	Jog speed setting	15	Jog frequency	15	Jog frequency	15	Jog frequency	15	Jog frequency
16	Jog acceleration/ deceleration time	16	Jog acceleration/ deceleration time	16	Jog acceleration/ deceleration time	16	Jog acceleration/ deceleration time	16	Jog acceleration/ deceleration time	
Standard operation function (V500 Series operation selection functions)	17	MRS input selection	17	MRS input selection	17	MRS input selection	—	—	17	RUN key rotation direction selection
	—	—	—	—	18	High speed maximum frequency	18	High speed maximum frequency	—	—
	19	Base frequency voltage	19	Base frequency voltage	19	Base frequency voltage ^{*3}	19	Base frequency voltage ^{*3}	19	Base frequency voltage ^{*3}

A Common Items
B N:N Network
C Parallel Link
D Computer Link
E Inverter Communication
F Non-Protocol Communication (RS/RS2 Instruction)
G Non-Protocol Communication (FAN-2321F)
H Programming Communication
I Remote Maintenance

Function	FREQROL V500 Series		FREQROL F500 Series		FREQROL A500 Series		FREQROL E500 Series		FREQROL S500 Series	
	Pr No.	Name	Pr No.	Name	Pr No.	Name	Pr No.	Name	Pr No.	Name
Standard operation function (V500 Series operation selection functions)	20	Acceleration/ deceleration reference speed	20	Acceleration/ deceleration reference frequency	20	Acceleration/ deceleration reference frequency	20	Acceleration/ deceleration reference frequency	20	Acceleration/ deceleration reference frequency
	21	Acceleration/ deceleration time increment	21	Acceleration/ deceleration time increment	21	Acceleration/ deceleration time increment	21	Acceleration/ deceleration time increment	21	Stall preventing function selection
	22	Torque restriction level	22	Stall prevention operation level	22	Stall prevention operation level	22	Stall prevention operation level	22	Stall prevention operation level
	—	—	23	Stall prevention operation level compensation factor at double speed	23	Stall prevention operation level compensation factor at double speed	23	Stall prevention operation level compensation factor at double speed	23	Stall prevention operation level compensation factor at double speed
	24	Multi-speed setting (speed 4)	24	Multi-speed setting (speed 4)	24	Multi-speed setting (speed 4)	24	Multi-speed setting (speed 4)	24	Multi-speed setting (speed 4)
	25	Multi-speed setting (speed 5)	25	Multi-speed setting (speed 5)	25	Multi-speed setting (speed 5)	25	Multi-speed setting (speed 5)	25	Multi-speed setting (speed 5)
	26	Multi-speed setting (speed 6)	26	Multi-speed setting (speed 6)	26	Multi-speed setting (speed 6)	26	Multi-speed setting (speed 6)	26	Multi-speed setting (speed 6)
	27	Multi-speed setting (speed 7)	27	Multi-speed setting (speed 7)	27	Multi-speed setting (speed 7)	27	Multi-speed setting (speed 7)	27	Multi-speed setting (speed 7)
	28	Multi-speed input compensation	28	Multi-speed input compensation	28	Multi-speed input compensation	—	—	28	Stall preventing operation reduction starting frequency
	29	Acceleration/ deceleration pattern	29	Acceleration/ deceleration pattern	29	Acceleration/ deceleration pattern	29	Acceleration/ deceleration pattern	29	Acceleration/ deceleration pattern
	30	Regenerative function selection	30	Regenerative function selection	30	Regenerative function selection	30	Regenerative function selection	—	—
	31	Speed jump 1A	31	Frequency jump 1A	31	Frequency jump 1A	31	Frequency jump 1A	31	Frequency jump 1A
	32	Speed jump 1B	32	Frequency jump 1B	32	Frequency jump 1B	32	Frequency jump 1B	32	Frequency jump 1B
	33	Speed jump 2A	33	Frequency jump 2A	33	Frequency jump 2A	33	Frequency jump 2A	33	Frequency jump 2A
	34	Speed jump 2B	34	Frequency jump 2B	34	Frequency jump 2B	34	Frequency jump 2B	34	Frequency jump 2B
	35	Speed jump 3A	35	Frequency jump 3A	35	Frequency jump 3A	35	Frequency jump 3A	35	Frequency jump 3A
	36	Speed jump 3B	36	Frequency jump 3B	36	Frequency jump 3B	36	Frequency jump 3B	36	Frequency jump 3B
	37	Speed display	37	Speed display	37	Speed display	37	Speed display	37	Speed display
	—	—	38	Automatic torque boost	—	—	38	Frequency at 5V (10V) input	38	Frequency setting voltage gain frequency
—	—	39	Automatic torque boost operation starting current	39			Frequency at 20mA input	39	Frequency setting current gain frequency	
—	—	—	—	—			—	40	Start-time ground fault detection selection	
Output terminal functions	41	Up-to-speed sensitivity	41	Up-to-frequency sensitivity	41	Up-to-frequency sensitivity	41	Up-to-frequency sensitivity	41	Up-to-frequency sensitivity
	42	Speed detection	42	Output frequency detection	42	Output frequency detection	42	Output frequency detection	42	Output frequency detection
	43	Speed detection for reverse rotation	43	Output frequency detection for reverse rotation	43	Output frequency detection for reverse rotation	43	Output frequency detection for reverse rotation	43	Output frequency detection for reverse rotation

Function	FREQROL V500 Series		FREQROL F500 Series		FREQROL A500 Series		FREQROL E500 Series		FREQROL S500 Series	
	Pr No.	Name	Pr No.	Name	Pr No.	Name	Pr No.	Name	Pr No.	Name
Second functions	44	Second acceleration/ deceleration time	44	Second acceleration/ deceleration time	44	Second acceleration/ deceleration time	44	Second acceleration/ deceleration time	44	Second acceleration/ deceleration time
	45	Second deceleration time	45	Second deceleration time	45	Second deceleration time	45	Second deceleration time	45	Second deceleration time
	—	—	46	Second torque boost	46	Second torque boost ^{*3}	46	Second torque boost ^{*3}	46	Second torque boost ^{*3}
			47	Second V/F (base frequency)	47	Second V/F (base frequency) ^{*3}	47	Second V/F (base frequency) ^{*3}	47	Second V/F (base frequency) ^{*3}
			48	Second stall prevention operation current	48	Second stall prevention operation current	48	Second electronic thermal O/L relay	—	—
	49	Second stall prevention operation frequency	49	Second stall prevention operation frequency	—	—				
50	Second speed detection	50	Second output frequency detection	50	Second output frequency detection	—	—	—	—	
Display functions	52	DU/PU main display data selection	52	DU/PU main display data selection	52	DU/PU main display data selection	52	Operation panel/ PU main display data selection	52	Control panel display data selection
	53	PU level display data selection	53	PU level display data selection	53	PU level display data selection	—	—	53	Frequency setting operation selection
	54	DA1 terminal function selection	54	FM terminal function selection	54	FM terminal function selection	54	FM terminal function selection	54	FM (AM) terminal function selection
	55	Speed monitoring reference	55	Frequency monitoring reference	55	Frequency monitoring reference	55	Frequency monitoring reference	55	Frequency monitoring reference
	56	Current monitoring reference	56	Current monitoring reference	56	Current monitoring reference	56	Current monitoring reference	56	Current monitoring reference
Restart	57	Restart coasting time	57	Restart coasting time	57	Restart coasting time	57	Restart coasting time	57	Restart coasting time
	58	Restart cushion time	58	Restart cushion time	58	Restart cushion time	58	Restart cushion time	58	Restart cushion time
Additional function	59	Remote setting function selection	59	Remote setting function selection	59	Remote setting function selection	59	Remote setting function selection	59	Remote setting function selection
Operation selecting functions	60	Intelligent mode selection	60	Intelligent mode selection	60	Intelligent mode selection	60	Shortest acceleration/ deceleration mode	—	—
	—	—	61	Reference I for intelligent mode	61	Reference I for intelligent mode	61	Reference current		
			62	Reference I for intelligent mode acceleration	62	Reference I for intelligent mode acceleration	62	Reference current for acceleration		
			63	Reference I for intelligent mode deceleration	63	Reference I for intelligent mode deceleration	63	Reference current for deceleration		
	—	—	—	—	64	Starting frequency for elevator mode	—	—		
	65	Retry selection	65	Retry selection	65	Retry selection	65	Retry selection	66	Retry selection
	—	—	66	Stall prevention operation level reduction starting frequency	66	Stall prevention operation level reduction starting frequency	66	Stall prevention operation level reduction starting frequency	—	—
67	Number of retries at alarm occurrence	67	Number of retries at alarm occurrence	67	Number of retries at alarm occurrence	67	Number of retries at alarm occurrence	67	Number of retries at alarm occurrence	

A	Common Items
B	N:N Network
C	Parallel Link
D	Computer Link
E	Inverter Communication
F	Non-Protocol Communication (RS/RS2 Instruction)
G	Non-Protocol Communication (FX2N-232IF)
H	Programming Communication
I	Remote Maintenance

	FREQROL V500 Series		FREQROL F500 Series		FREQROL A500 Series		FREQROL E500 Series		FREQROL S500 Series					
Function	Pr No.	Name	Pr No.	Name	Pr No.	Name	Pr No.	Name	Pr No.	Name				
Operation selecting functions	68	Retry waiting time	68	Retry waiting time	68	Retry waiting time	68	Retry waiting time	68	Retry waiting time				
	69	Retry count display erasure	69	Retry count display erasure	69	Retry count display erase	69	Retry count display erasure	69	Retry count display erase				
	70	Special regenerative brake duty	—	—	70	Special regenerative brake duty	70	Special regenerative brake duty	—	—				
	71	Applied motor	71	Applied motor	71	Applied motor	71	Applied motor	71	Applied motor				
	72	PWM frequency selection (simple mode)	72	PWM frequency selection	72	PWM frequency selection	72	PWM frequency selection	72	PWM frequency selection				
	73	Speed setting signal	73	0 to 5V/0 to 10V selection	73	0 to 5V/0 to 10V selection	73	0 to 5V/0 to 10V selection	73	0 to 5V/0 to 10V selection				
	—	—	74	Filter time constant	74	Filter time constant	74	Filter time constant	74	Input filter time constant				
	75	Reset selection/disconnected PU detection/PU stop selection	75	Reset selection/disconnected PU detection/PU stop selection	75	Reset selection/disconnected PU detection/PU stop selection	75	Reset selection/disconnected PU detection/PU stop selection	75	Reset selection/PU stop selection				
	—	—	76	Alarm code output selection	76	Alarm code output selection	—	—	—	—				
	77	Parameter write disable selection (simple mode)	77	Parameter write disable selection	77	Parameter write disable selection	77	Parameter write disable selection	77	Parameter write disable selection				
	78	Reverse rotation prevention selection	78	Reverse rotation prevention selection	78	Reverse rotation prevention selection	78	Reverse rotation prevention selection	78	Reverse rotation prevention selection				
79	Operation mode selection (simple mode)	79	Operation mode selection	79	Operation mode selection	79	Operation mode selection	79	Operation mode selection					
Motor constant	80	Motor capacity	—	—	80	Motor capacity	80	Motor capacity	—	—				
	81	Number of motor poles			81	Number of motor poles	—	—						
	82	Motor excitation current (no load current) ^{*1}			82	Motor excitation current ^{*5}	82	Motor excitation current						
	83	Rated motor voltage			83	Rated motor voltage	83	Rated motor voltage						
	84	Rated motor frequency			84	Rated motor frequency	84	Rated motor frequency						
	—	—			89	Speed control gain	—	—						
	90	Motor constant R1 ^{*1}			90	Motor constant (R1) ^{*5}	90	Motor constant (R1)						
	91	Motor constant R2 ^{*1}			91	Motor constant (R2) ^{*5}	—	—						
	92	Motor constant L1 ^{*1}			92	Motor constant (L1) ^{*5}								
	93	Motor constant L2 ^{*1}			93	Motor constant (L2) ^{*5}								
	94	Motor constant X ^{*1}			94	Motor constant (X) ^{*5}								
	95	Online auto tuning selection (simple mode)			—	—	95	Online auto tuning selection			—	—	—	—
	96	Auto tuning setting/status			—	—	96	Auto tuning setting/status			96	Auto tuning setting/status	—	—

Function	FREQROL V500 Series		FREQROL F500 Series		FREQROL A500 Series		FREQROL E500 Series		FREQROL S500 Series			
	Pr No.	Name	Pr No.	Name	Pr No.	Name	Pr No.	Name	Pr No.	Name		
5-point flexible V/F characteristics	—	—	100	V/F 1 (first frequency)	100	V/F 1 (first frequency) ^{*3}	—	—	—	—		
			101	V/F 1 (first frequency voltage)	101	V/F 1 (first frequency voltage) ^{*3}						
			102	V/F 2 (second frequency)	102	V/F 2 (second frequency) ^{*3}						
			103	V/F 2 (second frequency voltage)	103	V/F 2 (second frequency voltage) ^{*3}						
			104	V/F 3 (third frequency)	104	V/F 3 (third frequency) ^{*3}						
			105	V/F 3 (third frequency voltage)	105	V/F 3 (third frequency voltage) ^{*3}						
			106	V/F 4 (fourth frequency)	106	V/F 4 (fourth frequency) ^{*3}						
			107	V/F 4 (fourth frequency voltage)	107	V/F 4 (fourth frequency voltage) ^{*3}						
			108	V/F 5 (fifth frequency)	108	V/F 5 (fifth frequency) ^{*3}						
			109	V/F 5 (fifth frequency voltage)	109	V/F 5 (fifth frequency voltage) ^{*3}						
Third functions	110	Third acceleration /deceleration time	—	—	110	Third acceleration /deceleration time	—	—	—	—		
	111	Third deceleration time			111	Third deceleration time						
	—	—			112	Third torque boost ^{*3}					112	Third torque boost ^{*3}
					113	Third V/F (base frequency) ^{*3}					113	Third V/F (base frequency) ^{*3}
					114	Third stall prevention operation current					114	Third stall prevention operation current
					115	Third stall prevention operation frequency					115	Third stall prevention operation frequency
	116	Third speed detection			116	Third output frequency detection						
Communication functions	117	Communication station number	117	Communication station number	117	Communication station number	117	Communication station number	—	—		
	118	Communication speed	118	Communication speed	118	Communication speed	118	Communication speed				
	119	Stop bit length/ data length	119	Stop bit length/ data length	119	Stop bit length/ data length	119	Stop bit length/ data length				
	120	Parity check presence/ absence	120	Parity check presence/ absence	120	Parity check presence/ absence	120	Parity check presence/ absence				
	121	Number of communication retries	121	Number of communication retries	121	Number of communication retries	121	Number of communication retries				
	122	Communication check time interval	122	Communication check time interval	122	Communication check time interval	122	Communication check time interval				

A	Common Items
B	N:N Network
C	Parallel Link
D	Computer Link
E	Inverter Communication
F	Non-Protocol Communication (RS/RS2 Instruction)
G	Non-Protocol Communication (FX2N-232IF)
H	Programming Communication
I	Remote Maintenance

Function	FREQROL V500 Series		FREQROL F500 Series		FREQROL A500 Series		FREQROL E500 Series		FREQROL S500 Series	
	Pr No.	Name	Pr No.	Name	Pr No.	Name	Pr No.	Name	Pr No.	Name
Communi- cation functions	123	Waiting time setting	123	Waiting time setting	123	Waiting time setting	123	Waiting time setting	—	—
	124	CR and LF presence/absence selection	124	CR and LF presence/absence selection	124	CR and LF presence/absence selection	124	CR and LF presence/absence selection		
PID control	128	PID action selection	128	PID action selection	128	PID action selection	128	PID action selection	88	PID action selection
	129	PID proportional band	129	PID proportional band	129	PID proportional band	129	PID proportional band	89	PID proportional band
	130	PID integral time	130	PID integral time	130	PID integral time	130	PID integral time	90	PID integral time
	131	Maximum	131	Maximum	131	Maximum	131	Maximum	91	PID maximum
	132	Minimum	132	Minimum	132	Minimum	132	Minimum	92	PID minimum
	133	PID action set point for PU operation	133	PID action set point for PU operation	133	PID action set point for PU operation	133	PID action set point for PU operation	93	PID action set point for PU operation
Commer- cial power supply- inverter switch- over	—	—	135	Commercial power supply-inverter switch-over sequence output terminal selection	135	Commercial power supply-inverter switch-over sequence output terminal selection	—	—	—	—
			136	MC switch-over interlock time	136	MC switch-over interlock time				
			137	Start waiting time	137	Start waiting time				
			138	Commercial power supply-inverter switch-over selection at alarm occurrence	138	Commercial power supply-inverter switch-over selection at alarm occurrence				
			139	Automatic inverter-commercial power supply switch-over frequency	139	Automatic inverter-commercial power supply switch-over frequency				
Backlash	140	Backlash acceleration stopping speed	140	Backlash acceleration stopping frequency ^{*2}	140	Backlash acceleration stopping frequency ^{*2}	—	—	—	—
	141	Backlash acceleration stopping time	141	Backlash acceleration stopping time ^{*2}	141	Backlash acceleration stopping time ^{*2}				
	142	Backlash deceleration stopping speed	142	Backlash deceleration stopping frequency ^{*2}	142	Backlash deceleration stopping frequency ^{*2}				
	143	Backlash deceleration stopping time	143	Backlash deceleration stopping time ^{*2}	143	Backlash deceleration stopping time ^{*2}				
Display functions	144	Speed setting switchover	144	Speed setting switchover	144	Speed setting switchover	—	—	—	—
	145	PU display language selection	145	PU display language selection	145	PU display language selection	145	PU display language selection	n13 (145)	PU display language

	FREQROL V500 Series		FREQROL F500 Series		FREQROL A500 Series		FREQROL E500 Series		FREQROL S500 Series	
Function	Pr No.	Name	Pr No.	Name	Pr No.	Name	Pr No.	Name	Pr No.	Name
Additional functions	—	—	—	—	—	—	146	Frequency setting command selection	—	—
			148	Stall prevention operation level at 0 V input	148	Stall prevention operation level at 0 V input				
			149	Stall prevention operation level at 10 V input	149	Stall prevention operation level at 10 V input				
Current detection	150	Output current detection level	—	—	150	Output current detection level	150	Output current detection level	48	Output current detection level
	151	Output current detection period			151	Output current detection period	151	Output current detection period	49	Output current detection signal delay time
	152	Zero current detection level			152	Zero current detection level	152	Zero current detection level	50	Zero current detection level
	153	Zero current detection period			153	Zero current detection period	153	Zero current detection period	51	Zero current detection time
Sub functions	—	—	154	Voltage reduction selection during stall prevention operation	154	Voltage reduction selection during stall prevention operation	—	—	—	—
			155	RT activated condition	155	RT signal activated condition				
	156	Stall prevention operation selection	156	Stall prevention operation selection	156	Stall prevention operation selection				
	157	OL signal output timer	157	OL signal output waiting time	157	OL signal waiting time				
	158	DA2 terminal function selection	158	AM terminal function selection	158	AM terminal function selection				
Additional function	160	Extended function selection (simple mode)	160	User group read selection	160	User group read selection	160	User group read selection	—	—
Restart after instantaneous power failure	162	Automatic restart after instantaneous power failure selection	162	Automatic restart after instantaneous power failure selection	162	Automatic restart after instantaneous power failure selection	—	—	—	—
	163	First cushion time for restart	163	First cushion time for restart	163	First cushion time for restart				
	164	First cushion voltage for restart	164	First cushion voltage for restart	164	First cushion voltage for restart				
	165	Restart current reconstruction level	165	Restart stall prevention operation level	165	Restart stall prevention operation level				
Initial monitor value	—	—	170	Watt-hour meter clear	170	Watt-hour meter clear	—	—	—	—
	171	Actual operation hour meter clear	171	Actual operation hour meter clear	171	Actual operation hour meter clear				
User functions	—	—	173	User group 1 registration	173	User group 1 registration	173	User group 1 registration	—	—
			174	User group 1 deletion	174	User group 1 deletion	174	User group 1 deletion		
			175	User group 2 registration	175	User group 2 registration	175	User group 2 registration		
			176	User group 2 deletion	176	User group 2 deletion	176	User group 2 deletion		

A	Common Items
B	N:N Network
C	Parallel Link
D	Computer Link
E	Inverter Communication
F	Non-Protocol Communication (RS/RS2 Instruction)
G	Non-Protocol Communication (FX2N-232IF)
H	Programming Communication
I	Remote Maintenance

Function	FREQROL V500 Series		FREQROL F500 Series		FREQROL A500 Series		FREQROL E500 Series		FREQROL S500 Series	
	Pr No.	Name	Pr No.	Name	Pr No.	Name	Pr No.	Name	Pr No.	Name
Terminal assignment functions	180	DI1 terminal function selection	180	RL terminal function selection	180	RL terminal function selection	180	RL terminal function selection	60	RL terminal function selection
	181	DI2 terminal function selection	181	RM terminal function selection	181	RM terminal function selection	181	RM terminal function selection	61	RM terminal function selection
	182	DI3 terminal function selection	182	RH terminal function selection	182	RH terminal function selection	182	RH terminal function selection	62	RH terminal function selection
	183	DI4 terminal function selection	183	RT terminal function selection	183	RT terminal function selection	183	MRS terminal function selection		
	—	—	184	AU terminal function selection	184	AU terminal function selection			—	—
			185	JOG terminal function selection	185	JOG terminal function selection				
			186	CS terminal function selection	186	CS terminal function selection				
	187	STR terminal function selection	—	—	—	—	—	—	63	STR terminal function selection
	190	DO1 terminal function selection	190	RUN terminal function selection	190	RUN terminal function selection	190	RUN terminal function selection	64	RUN terminal function selection
	191	DO2 terminal function selection	191	SU terminal function selection	191	SU terminal function selection	191	FU terminal function selection	—	—
	192	DO3 terminal function selection	192	IPF terminal function selection	192	IPF terminal function selection	192	A/B/C terminal function selection	65	A/B/C terminal function selection
	—	—	193	OL terminal function selection	193	OL terminal function selection				
			194	FU terminal function selection	194	FU terminal function selection				
	195	A/B/C terminal function selection	195	A/B/C terminal function selection	195	A/B/C terminal function selection				
Additional function	—	—	199	User's initial value setting	199	User's initial value setting	—	—	—	—
Programmed operation					200	Programmed operation minute/second selection				
					201	Program set 1				
					202	Program set 1				
					203	Program set 1				
					204	Program set 1				
					205	Program set 1				
					206	Program set 1				
					207	Program set 1				
					208	Program set 1				
					209	Program set 1				
					210	Program set 1				
					211	Program set 2				
					212	Program set 2				
					213	Program set 2				
					214	Program set 2				
					215	Program set 2				
					216	Program set 2				
					217	Program set 2				
				218	Program set 2					
				219	Program set 2					
				220	Program set 2					
				221	Program set 3					
				222	Program set 3					
				223	Program set 3					

Function	FREQROL V500 Series		FREQROL F500 Series		FREQROL A500 Series		FREQROL E500 Series		FREQROL S500 Series		
	Pr No.	Name	Pr No.	Name	Pr No.	Name	Pr No.	Name	Pr No.	Name	
Programmed operation	—	—	—	—	224	Program set 3	—	—	—	—	
					225	Program set 3					
					226	Program set 3					
					227	Program set 3					
					228	Program set 3					
					229	Program set 3					
					230	Program set 3					
231	Timer setting										
Multi-speed operation	232	Multi-speed setting (speed 8)	—	—	232	Multi-speed setting (speed 8)	232	Multi-speed setting (speed 8)	80	Multi-speed setting (speed 8)	
	233	Multi-speed setting (speed 9)			233	Multi-speed setting (speed 9)	233	Multi-speed setting (speed 9)	81	Multi-speed setting (speed 9)	
	234	Multi-speed setting (speed 10)			234	Multi-speed setting (speed 10)	234	Multi-speed setting (speed 10)	82	Multi-speed setting (speed 10)	
	235	Multi-speed setting (speed 11)			235	Multi-speed setting (speed 11)	235	Multi-speed setting (speed 11)	83	Multi-speed setting (speed 11)	
	236	Multi-speed setting (speed 12)			236	Multi-speed setting (speed 12)	236	Multi-speed setting (speed 12)	84	Multi-speed setting (speed 12)	
	237	Multi-speed setting (speed 13)			237	Multi-speed setting (speed 13)	237	Multi-speed setting (speed 13)	85	Multi-speed setting (speed 13)	
	238	Multi-speed setting (speed 14)			238	Multi-speed setting (speed 14)	238	Multi-speed setting (speed 14)	86	Multi-speed setting (speed 14)	
	239	Multi-speed setting (speed 15)			239	Multi-speed setting (speed 15)	239	Multi-speed setting (speed 15)	87	Multi-speed setting (speed 15)	
Sub functions	240	Soft-PWM setting	240	Soft-PWM setting	240	Soft-PWM setting	240	Soft-PWM setting	70	Soft-PWM setting	
	244	Cooling fan operation selection	244	Cooling fan operation selection	244	Cooling fan operation selection	244	Cooling fan operation selection	76	Cooling fan operation selection	
	—	—	—	—	—	—	—	245	Rated motor slip	95	Rated motor slip
								246	Slip compensation response time	96	Slip compensation time constant
								247	Constant-output region slip compensation selection	97	Constant-output region slip compensation selection
								—	—	98	Automatic torque boost selection (motor capacity)
249	Earth (ground) fault detection at start*6	99	Motor primary resistance								
Stop selecting function	250	Stop selection	—	—	250	Stop selection	250	Stop selection	—	—	
Additional functions	251	Output phase failure protection selection	251	Output phase failure protection selection	251	Output phase failure protection selection	251	Output phase failure protection selection	—	—	
	252	Override bias	252	Override bias	252	Override bias	—	—	—	—	
	253	Override gain	253	Override gain	253	Override gain	—	—	—	—	
Power failure stop functions	261	Power failure stop selection	—	—	261	Power failure stop selection	—	—	—	—	
	262	Subtraction speed at deceleration start			262	Subtraction frequency at deceleration start					
	263	Subtraction starting speed			263	Subtraction starting frequency					
	264	Power-failure deceleration time 1			264	Power-failure deceleration time 1					

A	Common Items
B	N:N Network
C	Parallel Link
D	Computer Link
E	Inverter Communication
F	Non-Protocol Communication (RS/RS2 Instruction)
G	Non-Protocol Communication (FX2N-232IF)
H	Programming Communication
I	Remote Maintenance

	FREQROL V500 Series		FREQROL F500 Series		FREQROL A500 Series		FREQROL E500 Series		FREQROL S500 Series	
Function	Pr No.	Name	Pr No.	Name	Pr No.	Name	Pr No.	Name	Pr No.	Name
Power failure stop functions	265	Power-failure deceleration time 2	—	—	265	Power-failure deceleration time 2	—	—	—	—
	266	Power-failure deceleration time switchover speed			266	Power-failure deceleration time switchover frequency				
Function selection	—	—	—	—	270	Stop-on-contact/load torque high speed frequency control selection	—	—	—	—
High speed frequency control	—	—	—	—	271	High speed setting maximum current	—	—	—	—
					272	Middle speed setting minimum current				
					273	Current averaging range				
					274	Current averaging filter constant				
Stop-on-contact	—	—	—	—	275	Stop-on-contact exciting current low speed multiplying factor	—	—	—	—
					276	Stop-on-contact PWM carrier frequency				
Brake sequence function	278	Brake opening speed	—	—	278	Brake opening frequency ^{*4}	—	—	—	—
	279	Brake opening current			279	Brake opening current ^{*4}				
	280	Brake opening current detection time			280	Brake opening current detection time ^{*4}				
	281	Brake operation time at start			281	Brake operation time at start ^{*4}				
	282	Brake operation speed			282	Brake operation frequency ^{*4}				
	283	Brake operation time at stop			283	Brake operation time at stop ^{*4}				
	284	Deceleration detection function selection			284	Deceleration detection function selection ^{*4}				
	285	Overspeed detection speed			285	Overspeed detection frequency				
Droop control functions	286	Droop gain	—	—	286	Droop gain	—	—	—	—
	287	Droop filter constant			287	Droop filter constant				
	288	Droop function activation selection			—	—				
12-bit digital input	300	BCD input bias	300	BCD code input bias	300	BCD code input bias	—	—	—	—
	301	BCD input gain	301	BCD code input gain	301	BCD code input gain				
	302	Binary input bias	302	Binary input bias	302	Binary input bias				
	303	Binary input gain	303	Binary input gain	303	Binary input gain				

Function	FREQROL V500 Series		FREQROL F500 Series		FREQROL A500 Series		FREQROL E500 Series		FREQROL S500 Series	
	Pr No.	Name	Pr No.	Name	Pr No.	Name	Pr No.	Name	Pr No.	Name
12-bit digital input	304	Digital input and analog compensation input enable/disable selection	304	Selection of whether digital input and analog compensation input are enabled or disabled	304	Selection of whether digital input and analog compensation input are enabled or disabled	—	—	—	—
	305	Read timing operation selection	305	Data read timing signal on/off selection	305	Data read timing signal on/off selection	—	—	—	—
Analog output/digital output	306	Analog output signal selection	306	Analog output signal selection	306	Analog output signal selection	—	—	—	—
	307	Setting for zero analog output	307	Setting for zero analog output	307	Setting for zero analog output	—	—	—	—
	308	Setting for maximum analog output	308	Setting for maximum analog output	308	Setting for maximum analog output	—	—	—	—
	309	Analog output signal voltage/current switchover	309	Analog output signal voltage/current switchover	309	Analog output signal voltage/current switchover	—	—	—	—
	310	Analog meter voltage output selection	310	Analog meter voltage output selection	310	Analog meter voltage output selection	—	—	—	—
	311	Setting for zero analog meter voltage output	311	Setting for zero analog meter voltage output	311	Setting for zero analog meter voltage output	—	—	—	—
	312	Setting for maximum analog meter voltage output	312	Setting for maximum analog meter voltage output	312	Setting for maximum analog meter voltage output	—	—	—	—
	313	Y0 output selection	313	Y0 output selection	313	Y0 output selection	—	—	—	—
	314	Y1 output selection	314	Y1 output selection	314	Y1 output selection	—	—	—	—
	315	Y2 output selection	315	Y2 output selection	315	Y2 output selection	—	—	—	—
	316	Y3 output selection	316	Y3 output selection	316	Y3 output selection	—	—	—	—
	317	Y4 output selection	317	Y4 output selection	317	Y4 output selection	—	—	—	—
Relay output	320	RA1 output selection	320	RA1 output selection	320	RA1 output selection	—	—	—	—
	321	RA2 output selection	321	RA2 output selection	321	RA2 output selection	—	—	—	—
	322	RA3 output selection	322	RA3 output selection	322	RA3 output selection	—	—	—	—
Digital input	329	Digital input unit selection	—	—	—	—	—	—	—	—
Relay output	330	RA output selection	330	RA output selection	330	RA output selection	—	—	—	—
Computer link function (S500 Series communication parameter)	331	Communication station number	331	Inverter station number	331	Communication station number	—	—	n1 (331)	Communication station number
	332	Communication speed	332	Communication speed	332	Communication speed	—	—	n2 (332)	Communication speed
	333	Stop bit length/data length	333	Stop bit length/data length	333	Stop bit length/data length	—	—	n3 (333)	Stop bit length/data length
	334	Parity check presence/absence	334	Parity check yes/no	334	Parity check yes/no	—	—	n4 (334)	Parity check presence/absence
	335	Number of communication retries	335	Communication retry count	335	Communication retry count	—	—	n5 (335)	Number of communication retries

A	Common Items
B	N:N Network
C	Parallel Link
D	Computer Link
E	Inverter Communication
F	Non-Protocol Communication (RS/RS2 Instruction)
G	Non-Protocol Communication (FX2N-232IF)
H	Programming Communication
I	Remote Maintenance

	FREQROL V500 Series		FREQROL F500 Series		FREQROL A500 Series		FREQROL E500 Series		FREQROL S500 Series	
Function	Pr No.	Name	Pr No.	Name	Pr No.	Name	Pr No.	Name	Pr No.	Name
Computer link function (S500 Series communication parameter)	336	Communication check time interval	336	Communication check time interval	336	Communication check time interval	—	—	n6 (336)	Communication check time interval
	337	Waiting time setting	337	Waiting time setting	337	Waiting time setting	—	—	n7 (337)	Wait time setting
	338	Operation command source	338	Operation command write	338	Operation command right	338	Operation command source	n8 (338)	Operation command write
	339	Speed command source	339	Speed command write	339	Speed command write	339	Speed command source	n9 (339)	Speed command write
	340	Link startup mode selection	340	Link startup mode selection	340	Link startup mode selection	340	Link startup mode selection	n10 (340)	Link start mode selection
	341	CR and LF presence/absence selection	341	CR and LF yes/no selection	341	CR and LF yes/no selection	—	—	n11 (341)	CR and LF selection
	342	EEPROM write selection	342	EEPROM write selection	342	EEPROM write selection	342	EEPROM write selection	n12 (342)	EEPROM write selection
DeviceNet communication	345	DeviceNet address (lower)	345	DeviceNet address startup data (lower byte)	345	DeviceNet address startup data (lower byte)	345	DeviceNet address startup data (lower byte)	—	—
	346	DeviceNet baud rate (lower)	346	DeviceNet baud rate startup data (lower byte)	346	DeviceNet baud rate startup data (lower byte)	346	DeviceNet baud rate startup data (lower byte)	—	—
	347	DeviceNet address (higher)	—	—	347	DeviceNet address startup data (higher byte)	347	DeviceNet address startup data (higher byte)	—	—
	348	DeviceNet baud rate (higher)	—	—	348	DeviceNet baud rate startup data (higher byte)	348	DeviceNet baud rate startup data (higher byte)	—	—
Orientation control/ encoder feedback control/ pulse train input	350	Stop position command selection	—	—	350	Stop position command selection	—	—	—	—
	351	Orientation switchover speed	—	—	351	Orientation switchover speed	—	—	—	—
	—	—	—	—	352	Creep speed	—	—	—	—
	—	—	—	—	353	Creep switch position	—	—	—	—
	—	—	—	—	354	Position loop switchover position	—	—	—	—
	—	—	—	—	355	DC injection start position	—	—	—	—
	356	Internal stop position command	—	—	356	Internal stop position command	—	—	—	—
	357	In-position zone	—	—	357	In-position zone	—	—	—	—
	—	—	—	—	358	Servo torque selection	—	—	—	—
	359	Orientation encoder rotation direction	—	—	359	Encoder rotation direction	—	—	—	—
	360	External position command selection	—	—	360	12-bit data selection	—	—	—	—
	361	Position shift	—	—	361	Position shift	—	—	—	—
	362	Orientation position loop gain	—	—	362	Position loop gain	—	—	—	—
—	—	—	—	363	Completion signal output delay time	—	—	—	—	

Function	FREQROL V500 Series		FREQROL F500 Series		FREQROL A500 Series		FREQROL E500 Series		FREQROL S500 Series			
	Pr No.	Name	Pr No.	Name	Pr No.	Name	Pr No.	Name	Pr No.	Name		
Orientation control/ encoder feedback control/ pulse train input	—	—	—	—	364	Encoder stop check time	—	—	—	—		
					365	Orientation censored limit						
					366	Reconfirmation time						
					367	Speed feedback range						
					368	Feedback gain						
	369	Number of orientation encoder pulse			369	Number of orientation encoder pulse						
	—	—			370	Control mode selection					370	Control mode selection
					371	Torque characteristic selection					371	Torque characteristic selection
					372	Speed control P gain					372	Speed control P gain
	373	Speed control I gain			373	Speed control I gain						
	374	Over-speed detection level			374	Over-speed detection level						
	—	—			375	Servo lock gain					375	Servo lock gain
					376	Disconnection detection selection					376	Disconnection detection selection
	380	Acceleration S pattern 1			380	Acceleration S pattern 1						
	381	Deceleration S pattern 1			381	Deceleration S pattern 1						
	382	Acceleration S pattern 2			382	Acceleration S pattern 2						
	383	Deceleration S pattern 2			383	Deceleration S pattern 2						
384	Input pulse division scaling factor	384	Input pulse division scaling factor									
385	Speed for zero input pulse	385	Frequency for zero input pulse									
386	Speed for maximum input pulse	386	Frequency for maximum input pulse									
LONWORKS® function	—	—	—	—	—	—	—	—	—	387	Initial communication delay time	
										388	Send time interval at hart beat	
										389	Minimum sending time at hart beat	
										390	% setting reference frequency	
										391	Receive time interval at hart beat	
										392	Event-driven detection width	

A	Common Items
B	N:N Network
C	Parallel Link
D	Computer Link
E	Inverter Communication
F	Non-Protocol Communication (RS/RS2 Instruction)
G	Non-Protocol Communication (FX2N-232IF)
H	Programming Communication
I	Remote Maintenance

	FREQROL V500 Series		FREQROL F500 Series		FREQROL A500 Series		FREQROL E500 Series		FREQROL S500 Series	
Function	Pr No.	Name	Pr No.	Name	Pr No.	Name	Pr No.	Name	Pr No.	Name
Orientation selection	393	Orientation selection	—	—	—	—	—	—	—	—
	394	Number of machine side gear teeth								
	395	Number of motor side gear teeth								
	396	Orientation speed gain (P term)								
	397	Orientation speed integral time								
	398	Orientation speed gain (D term)								
	399	Orientation deceleration ratio								
Extension input	400	DI11 terminal function selection	—	—	—	—	—	—	—	—
	401	DI12 terminal function selection								
	402	DI13 terminal function selection								
	403	DI14 terminal function selection								
	404	DI15 terminal function selection								
	405	DI16 terminal function selection								
	406	High resolution analog input selection								
	407	Motor temperature detection filter								
Extension output	410	DO11 terminal function selection	—	—	—	—	—	—	—	—
	411	DO12 terminal function selection								
	412	DO13 terminal function selection								
	413	Encoder pulse output division ratio								
Positioning control	419	Position command source selection	—	—	—	—	—	—	—	—
	420	Command pulse scaling factor numerator								
	421	Command pulse scaling factor denominator								
	422	Position loop gain								
	423	Position feed forward gain								
	424	Position command acceleration/ deceleration time constant								

Function	FREQROL V500 Series		FREQROL F500 Series		FREQROL A500 Series		FREQROL E500 Series		FREQROL S500 Series	
	Pr No.	Name	Pr No.	Name	Pr No.	Name	Pr No.	Name	Pr No.	Name
Positioning control	425	Position feed forward command filter	—	—	—	—	—	—	—	—
	426	In-position width								
	427	Excessive level error								
	428	Command pulse selection								
	429	Clear signal selection								
	430	Pulse monitor selection								
Torque command	432	Pulse train torque command bias	—	—	—	—	—	—	—	—
	433	Pulse train torque command gain								
Position control	434	IP address 1	—	—	—	—	—	—	—	—
	435	IP address 2								
	436	IP address 3								
	437	IP address 4								
	438	Sub-net mask 1								
	439	Sub-net mask 2								
	440	Sub-net mask 3								
	441	Sub-net mask 4								
	442	Gateway address 1								
	443	Gateway address 2								
	444	Gateway address 3								
	445	Gateway address 4								
446	Password									
Torque command	447	Digital torque command bias	—	—	—	—	—	—	—	—
	448	Digital torque command gain								
Motor constant	450	Second applied motor	—	—	—	—	—	—	—	—
	451	Second motor control method selection								
	452	Second electronic thermal O/L relay								
	453	Second motor capacity								
	454	Number of second motor poles								
Position control	464	Digital position control sudden stop deceleration time	—	—	—	—	—	—	—	—
	465	First position feed amount lower 4 digits								
	466	First position feed amount upper 4 digits								
	467	Second position feed amount lower 4 digits								

A	Common Items
B	N:N Network
C	Parallel Link
D	Computer Link
E	Inverter Communication
F	Non-Protocol Communication (RS/RS2 Instruction)
G	Non-Protocol Communication (FX2N-232IF)
H	Programming Communication
I	Remote Maintenance

	FREQROL V500 Series		FREQROL F500 Series		FREQROL A500 Series		FREQROL E500 Series		FREQROL S500 Series	
Function	Pr No.	Name	Pr No.	Name	Pr No.	Name	Pr No.	Name	Pr No.	Name
Position control	468	Second position feed amount upper 4 digits								
	469	Third position feed amount lower 4 digits								
	470	Third position feed amount upper 4 digits								
	471	Fourth position feed amount lower 4 digits								
	472	Fourth position feed amount upper 4 digits								
	473	Fifth position feed amount lower 4 digits								
	474	Fifth position feed amount upper 4 digits								
	475	Sixth position feed amount lower 4 digits								
	476	Sixth position feed amount upper 4 digits								
	477	Seventh position feed amount lower 4 digits								
	478	Seventh position feed amount upper 4 digits								
	479	Eighth position feed amount lower 4 digits								
	480	Eighth position feed amount upper 4 digits								
	481	Ninth position feed amount lower 4 digits								
	482	Ninth position feed amount upper 4 digits								
	483	Tenth position feed amount lower 4 digits								
	484	Tenth position feed amount upper 4 digits								
	485	Eleventh position feed amount lower 4 digits								
486	Eleventh position feed amount upper 4 digits									
487	Twelfth position feed amount lower 4 digits									

Function	FREQROL V500 Series		FREQROL F500 Series		FREQROL A500 Series		FREQROL E500 Series		FREQROL S500 Series	
	Pr No.	Name	Pr No.	Name	Pr No.	Name	Pr No.	Name	Pr No.	Name
Position control	488	Twelfth position feed amount upper 4 digits								
	489	Thirteenth position feed amount lower 4 digits								
	490	Thirteenth position feed amount upper 4 digits								
	491	Fourteenth position feed amount lower 4 digits	—	—	—	—	—	—	—	—
	492	Fourteenth position feed amount upper 4 digits								
	493	Fifteenth position feed amount lower 4 digits								
	494	Fifteenth position feed amount upper 4 digits								
Remote output	495	Remote output selection								
	496	Remote output data 1	—	—	—	—	—	—	—	—
	497	Remote output data 2								
Communication (F500 Series Advanced PID control functions)	499	Action selection at SSCNET communication interruption	—	—	—	—	—	—	—	—
	500	Communication error recognition waiting time	500	Auxiliary motor operation	500	Communication error recognition waiting time	500	Communication error recognition waiting time	—	—
	501	Communication error occurrence count display	501	Motor switch-over selection	501	Communication error occurrence count display	501	Communication error occurrence count display		
	502	Stop mode selection at communication error	502	MC switching interlock time	502	Communication error-time stop mode selection	502	Stop mode selection at communication error		
Capacitor life (F500 Series Advanced PID control functions)			503	Start waiting time	503	Capacitor life timer				
			504	Auxiliary motor connection-time deceleration time	504	Capacitor life alarm output setting time				
			505	Auxiliary motor disconnection-time acceleration time						
			506	Output stop detection time						
			507	Output stop detection level	—	—				
			508	Output stop cancel process value level						
			509	Auxiliary motor 1 starting frequency						

A	Common Items
B	N:N Network
C	Parallel Link
D	Computer Link
E	Inverter Communication
F	Non-Protocol Communication (RS/RS2 Instruction)
G	Non-Protocol Communication (FX2N-232IF)
H	Programming Communication
I	Remote Maintenance

	FREQROL V500 Series		FREQROL F500 Series		FREQROL A500 Series		FREQROL E500 Series		FREQROL S500 Series	
Function	Pr No.	Name	Pr No.	Name	Pr No.	Name	Pr No.	Name	Pr No.	Name
Capacitor life (F500 Series Advanced PID control functions)	—	—	510	Auxiliary motor 2 starting frequency	—	—	—	—	—	—
			511	Auxiliary motor 3 starting frequency						
			512	Auxiliary motor 1 stopping frequency						
			513	Auxiliary motor 2 stopping frequency						
			514	Auxiliary motor 3 stopping frequency						
			515	Auxiliary motor start delay time						
			516	Auxiliary motor start delay time						
Restart after instantaneous power failure	—	—	—	—	611	Restart acceleration time	—	—	—	—
Operation selecting function	800	Control system selection (simple mode)	—	—	—	—	—	—	—	—
	801	Torque characteristic selection								
	802	Pre-excitation selection								
	803	Constant output region torque characteristic selection								
	804	Torque command source selection								
	805	Torque command source (RAM)								
	806	Torque command source (RAM, EEPROM)								
	807	Speed restriction selection								
	808	Forward rotation speed restriction								
	809	Reverse rotation speed restriction								
Control system function (A500 Series vector control)	810	Torque restriction input method selection	—	—	—	—	—	—	—	—
	812	Torque restriction level (regeneration)								
	813	Torque restriction level (3rd quadrant)								
	814	Torque restriction level (4th quadrant)								

Function	FREQROL V500 Series		FREQROL F500 Series		FREQROL A500 Series		FREQROL E500 Series		FREQROL S500 Series	
	Pr No.	Name	Pr No.	Name	Pr No.	Name	Pr No.	Name	Pr No.	Name
Control system function (A500 Series vector control)	815	Torque restriction level 2	—	—	—	—	—	—	—	—
	816	Acceleration torque restriction level			816	Acceleration torque restriction level				
	817	Deceleration torque restriction level			817	Deceleration torque restriction level				
	818	Easy gain tuning response level setting (simple mode)								
	819	Easy gain tuning selection (simple mode)								
	820	Speed control P gain 1								
	821	Speed control integral time 1								
	822	Speed setting filter 1								
	823	Speed detection filter 1								
	824	Torque control P gain 1								
	825	Torque control integral time 1								
	826	Torque setting filter 1								
	827	Torque detection filter 1								
	828	Model speed control gain								
	830	Speed control P gain 2								
	831	Speed control integral time 2								
	832	Speed setting filter 2								
	833	Speed detection filter 2								
834	Torque control P gain 2									
835	Torque control integral time 2									
836	Torque setting filter 2									
837	Torque detection filter 2									
Torque biases	840	Torque bias selection	—	—	—	—	—	—	—	—
	841	Torque bias 1								
	842	Torque bias 2								
	843	Torque bias 3								
	844	Torque bias filter								
	845	Torque bias operation time								

A	Common Items
B	N:N Network
C	Parallel Link
D	Computer Link
E	Inverter Communication
F	Non-Protocol Communication (RS/RS2 Instruction)
G	Non-Protocol Communication (FX2N-232IF)
H	Programming Communication
I	Remote Maintenance

Function	FREQROL V500 Series		FREQROL F500 Series		FREQROL A500 Series		FREQROL E500 Series		FREQROL S500 Series	
	Pr No.	Name	Pr No.	Name	Pr No.	Name	Pr No.	Name	Pr No.	Name
Torque biases	846	Torque bias balance compensation	—	—	—	—	—	—	—	—
	847	Fall-time torque bias No. 3 bias								
	848	Fall-time torque bias No. 3 gain								
	849	Analog input offset adjustment								
Additional functions	851	Number of encoder pulses	—	—	—	—	—	—	—	—
	852	Encoder rotation direction								
	854	Excitation ratio								
	859	Torque current								
	862	Notch filter frequency								
	863	Notch filter depth								
	864	Torque detection								
Display functions	866	Torque monitoring reference	—	—	—	—	—	—	—	—
	867	DA1 output filter								
Terminal assignment function	868	No. 1 terminal function assignment	—	—	—	—	—	—	—	—
Protection functions	870	Speed deviation level	—	—	—	—	—	—	—	—
	871	Speed deviation time								
	873	Speed restriction								
	874	OLT level setting								
Operation selecting functions	875	Fault definition	—	—	—	—	—	—	—	—
	876	Thermal relay protector input								
Control system functions	877	Speed feed forward/model adaptive speed control selection	—	—	—	—	—	—	—	—
	878	Speed feed forward filter								
	879	Speed feed forward torque restriction								
	880	Load inertia ratio								
	881	Speed feed forward gain								
Maintenance functions	890	Maintenance output setting time	—	—	—	—	—	—	—	—
	891	Maintenance output timer								
	892	Maintenance output signal clear								

Function	FREQROL V500 Series		FREQROL F500 Series		FREQROL A500 Series		FREQROL E500 Series		FREQROL S500 Series	
	Pr No.	Name	Pr No.	Name	Pr No.	Name	Pr No.	Name	Pr No.	Name
Calibration functions	900	DA1 terminal calibration	900	FM terminal calibration	900	FM terminal calibration	900	FM terminal calibration	C1 (900 (901))	FM (AM) terminal calibration
	901	DA2 terminal calibration	901	AM terminal calibration	901	AM terminal calibration	—	—	—	—
	902	Speed setting No. 2 bias	902	Frequency setting voltage bias	902	Frequency setting voltage bias	902	Frequency setting voltage bias	C2 (902)	Frequency setting voltage bias frequency
									C3 (902)	Frequency setting voltage bias
	903	Speed setting No. 2 gain	903	Frequency setting voltage gain	903	Frequency setting voltage gain	903	Frequency setting voltage gain	C4 (903)	Frequency setting voltage gain
	904	Torque command No. 3 bias	904	Frequency setting current bias	904	Frequency setting current bias	904	Frequency setting current bias	C5 (904)	Frequency setting current bias frequency
									C6 (904)	Frequency setting current bias
	905	Torque command No. 3 gain	905	Frequency setting current gain	905	Frequency setting current gain	905	Frequency setting current gain	C7 (905)	Frequency setting current gain
	—	—	—	—	—	—	—	—	C8 (269)	Parameter set by manufacturer. Do not set.
	917	No. 1 terminal bias (speed)								
	918	No. 1 terminal gain (speed)								
	919	No. 1 terminal bias (torque/magnetic flux)								
	920	No. 1 terminal gain (torque/magnetic flux)								
	922	Built-in frequency setting potentiometer bias ^{*7}								
	923	Built-in frequency setting potentiometer gain ^{*7}								
925	Motor temperature detection calibration									
926	No. 6 terminal bias (speed)									
927	No. 6 terminal gain (speed)									
928	No. 6 terminal bias (torque)									
929	No. 6 terminal gain (torque)									
Additional functions	990	PU buzzer control	990	PU buzzer control	990	PU Buzzer control	990	PU buzzer control	n14 (990)	PU buzzer sound control
	991	PU contrast adjustment	991	PU contrast adjustment	991	PU contrast adjustment	991	PU contrast adjustment	n15 (991)	PU contrast adjustment
	—	—	—	—	—	—	—	—	n16 (992)	PU main display screen data selection

A	Common Items
B	N:N Network
C	Parallel Link
D	Computer Link
E	Inverter Communication
F	Non-Protocol Communication (RS/RS2 Instruction)
G	Non-Protocol Communication (FX2N-232IF)
H	Programming Communication
I	Remote Maintenance

	FREQROL V500 Series		FREQROL F500 Series		FREQROL A500 Series		FREQROL E500 Series		FREQROL S500 Series	
Function	Pr No.	Name	Pr No.	Name	Pr No.	Name	Pr No.	Name	Pr No.	Name
Additional functions	—	—	—	—	—	—	—	—	n17 (993)	PU disconnection detection/PU setting lock

The parameters No. 77 and No. 79 cannot be written in computer link operation using the FR-A5NR.

- *1. Can be read or written when the parameter No. 77 is set to "801".
- *2. Can be read or written when the parameter No. 29 is set to "3".
- *3. Indicates a parameter whose setting is ignored when the advanced magnetic flux vector control mode is selected.
- *4. Can be set when the parameters Nos. 80 and 81 are not set to "9999" and the parameter No. 60 is set to "7" or "8".
- *5. Can be read or written when the parameters Nos. 80 and 81 are not set to "9999" and the parameter No. 77 is set to "801".
- *6. Can be set only in the 200 V/100 V class.
- *7. Cannot be used in inverter communication.

12.5.2 Parameters in F700, A700 Series

The following parameters are provided in the F700 and A700 Series inverters. (For details, make sure to refer to the manual of each inverter.)

Function	FREQROL F700 Series		Function	FREQROL A700 Series	
	Parameters	Name		Parameters	Name
Basic functions	0	Torque boost	Basic Functions	0	Torque boost
	1	Maximum frequency		1	Maximum frequency
	2	Minimum frequency		2	Minimum frequency
	3	Base frequency		3	Base frequency
	4	Multi-speed setting (high speed)		4	Multi-speed setting (high speed)
	5	Multi-speed setting (middle speed)		5	Multi-speed setting (middle speed)
	6	Multi-speed setting (low speed)		6	Multi-speed setting (low speed)
	7	Acceleration time		7	Acceleration time
	8	Deceleration time		8	Deceleration time
DC injection brake	9	Electronic thermal O/L relay	DC injection brake	9	Electronic thermal O/L relay
	10	DC injection brake operation frequency		10	DC injection brake operation frequency
	11	DC injection brake operation time		11	DC injection brake operation time
-	12	DC injection brake operation voltage	-	12	DC injection brake operation voltage
-	13	Starting frequency	-	13	Starting frequency
-	14	Load pattern selection	-	14	Load pattern selection
Jog operation	15	Jog frequency	Jog operation	15	Jog frequency
	16	Jog acceleration/deceleration time		16	Jog acceleration/deceleration time
-	17	MRS input selection	-	17	MRS input selection
-	18	High speed maximum frequency	-	18	High speed maximum frequency
-	19	Base frequency voltage	-	19	Base frequency voltage
Acceleration/ deceleration times	20	Acceleration/deceleration reference frequency	Acceleration/ deceleration times	20	Acceleration/deceleration reference frequency
	21	Acceleration/deceleration time increments		21	Acceleration/deceleration time increments
Stall prevention	22	Stall prevention operation level	Stall prevention	22	Stall prevention operation level (torque limit level)
	23	Stall prevention operation level compensation factor at double speed		23	Stall prevention operation level compensation factor at double speed
Multi-speed setting	24	Multi-speed setting (speed 4)	Multi-speed setting	24	Multi-speed setting (speed 4)
	25	Multi-speed setting (speed 5)		25	Multi-speed setting (speed 5)
	26	Multi-speed setting (speed 6)		26	Multi-speed setting (speed 6)
	27	Multi-speed setting (speed 7)		27	Multi-speed setting (speed 7)
-	28	Multi-speed input compensation selection	-	28	Multi-speed input compensation selection
-	29	Acceleration/deceleration pattern selection	-	29	Acceleration/deceleration pattern selection
-	30	Regenerative function selection	-	30	Regenerative function selection
Frequency jump	31	Frequency jump 1A	Frequency jump	31	Frequency jump 1A
	32	Frequency jump 1B		32	Frequency jump 1B
	33	Frequency jump 2A		33	Frequency jump 2A
	34	Frequency jump 2B		34	Frequency jump 2B
	35	Frequency jump 3A		35	Frequency jump 3A
	36	Frequency jump 3B		36	Frequency jump 3B
-	37	Speed display	-	37	Speed display

A	Common Items
B	N:N Network
C	Parallel Link
D	Computer Link
E	Inverter Communication
F	Non-Protocol Communication (RS/RS2 Instruction)
G	Non-Protocol Communication (FX2N-232IF)
H	Programming Communication
I	Remote Maintenance

FREQROL F700 Series			FREQROL A700 Series		
Function	Parameters	Name	Function	Parameters	Name
Frequency detection	41	Up-to-frequency sensitivity	Frequency detection	41	Up-to-frequency sensitivity
	42	Output frequency detection		42	Output frequency detection
	43	Output frequency detection for reverse rotation		43	Output frequency detection for reverse rotation
Second functions	44	Second acceleration/deceleration time	Second functions	44	Second acceleration/deceleration time
	45	Second deceleration time		45	Second deceleration time
	46	Second torque boost		46	Second torque boost
	47	Second V/F (base frequency)		47	Second V/F (base frequency)
	48	Second stall prevention operation current		48	Second stall prevention operation current
	49	Second stall prevention operation frequency		49	Second stall prevention operation frequency
	50	Second output frequency detection		50	Second output frequency detection
Monitor functions	51	Second electronic thermal O/L relay	Monitor functions	51	Second electronic thermal O/L relay
	52	DU/PU main display data selection		52	DU/PU main display data selection
	54	FM terminal function selection		54	FM terminal function selection
	55	Frequency monitoring reference		55	Frequency monitoring reference
Automatic restart functions	56	Current monitoring reference	Automatic restart	56	Current monitoring reference
	57	Restart coasting time		57	Restart coasting time
-	58	Restart cushion time	-	58	Restart cushion time
-	59	Remote function selection	-	59	Remote function selection
-	60	Energy saving control selection	-	60	Energy saving control selection
-	-	-	Automatic acceleration/deceleration	61	Reference current
-	-	-		62	Reference value at acceleration
-	-	-		63	Reference value at deceleration
-	-	-		64	Starting frequency for elevator mode
-	65	Retry selection	-	65	Retry selection
-	66	Stall prevention operation reduction starting frequency	-	66	Stall prevention operation reduction starting frequency
Retry	67	Number of retries at alarm occurrence	Retry	67	Number of retries at alarm occurrence
	68	Retry waiting time		68	Retry waiting time
	69	Retry count display erase		69	Retry count display erase
-	70	Special regenerative brake duty	-	70	Special regenerative brake duty
-	71	Applied motor	-	71	Applied motor
-	72	PWM frequency selection	-	72	PWM frequency selection
-	73	Analog input selection	-	73	Analog input selection
-	74	Input filter time constant	-	74	Input filter time constant
-	75	Reset selection/disconnected PU detection/PU stop selection	-	75	Reset selection/disconnected PU detection/PU stop selection
-	76	Alarm code output selection	-	76	Alarm code output selection
-	77	Parameter write selection	-	77	Parameter write selection
-	78	Reverse rotation prevention selection	-	78	Reverse rotation prevention selection
-	79	Operation mode selection	-	79	Operation mode selection

Function	FREQROL F700 Series		Function	FREQROL A700 Series	
	Parameters	Name		Parameters	Name
Simple magnetic flux vector control	80	Motor capacity (simple magnetic flux vector control)	Motor constants	80	Motor capacity
	-	-		81	Number of motor poles
	-	-		82	Motor excitation current
-	-	83		Motor rated voltage	
-	-	84		Rated motor frequency	
-	-	89		Speed control gain (magnetic flux vector)	
-	-	90		Motor constant (R1)	
-	-	91		Motor constant (R2)	
-	-	92		Motor constant (L1)	
-	-	93		Motor constant (L2)	
-	-	94	Motor constant (X)		
-	-	95	Online auto tuning selection		
-	-	96	Auto tuning setting/status		
Adjustable 5 points V/F	100	V/F1 (first frequency)	Adjustable 5 points V/F	100	V/F1(first frequency)
	101	V/F1 (first frequency voltage)		101	V/F1(first frequency voltage)
	102	V/F2 (second frequency)		102	V/F2(second frequency)
	103	V/F1 (first frequency)		103	V/F2(second frequency voltage)
	104	V/F3 (third frequency)		104	V/F3(third frequency)
	105	V/F3 (third frequency voltage)		105	V/F3(third frequency voltage)
	106	V/F4 (fourth frequency)		106	V/F4(fourth frequency)
	107	V/F4 (fourth frequency voltage)		107	V/F4(fourth frequency voltage)
	108	V/F5 (fifth frequency)		108	V/F5(fifth frequency)
-	-	-	109	V/F5(fifth frequency voltage)	
-	-	-	Third functions	110	Third acceleration/deceleration time
				111	Third deceleration time
				112	Third torque boost
				113	Third V/F (base frequency)
				114	Third stall prevention operation current
				115	Thrid stall prevention operation frequency
				116	Thrid output frequency detection
PU connector communication	117	PU communication station	PU connector communication	117	PU communication station number
	118	PU communication speed		118	PU communication speed
	119	PU communication stop bit length.		119	PU communication stop bit length
	120	PU communication parity check		120	PU communication parity check
	121	Number of PU communication retries		121	Number of PU communication retries
	122	PU communication check time interval		122	PU communication check time interval
	123	PU communication waiting time setting		123	PU communication waiting time setting
-	-	-	124	PU communication CR/LF presence/absence selection	
-	125	Terminal 2 frequency setting gain frequency	-	125	Terminal 2 frequency setting gain frequency
-	126	Terminal 4 frequency setting gain frequency	-	126	Terminal 4 frequency setting gain frequency

A	Common Items
B	N:N Network
C	Parallel Link
D	Computer Link
E	Inverter Communication
F	Non-Protocol Communication (RS/RS2 Instruction)
G	Non-Protocol Communication (FX2N-232IF)
H	Programming Communication
I	Remote Maintenance

Function	FREQROL F700 Series		Function	FREQROL A700 Series	
	Parameters	Name		Parameters	Name
PID operation	127	PID control automatic switchover frequency	PID operation	127	PID control automatic switchover frequency
	128	PID action selection		128	PID action selection
	129	PID proportional band		129	PID proportional band
	130	PID integral time		130	PID integral time
	131	PID maximum		131	PID upper limit
	132	PID minimum		132	PID lower limit
	133	PID action set point		133	PID action set point
	134	PID differential time	134	PID differential time	
Commercial power supply-inverter switch-over	135	Commercial power-supply switchover sequence output terminal selection	Electronic bypass	135	Electronic bypass sequence selection
	136	MC switchover interlock time		136	MC switchover interlock time
	137	Waiting time at a start		137	Start waiting time
	138	Commercial power-supply operation switchover selection at an alarm		138	Bypass selection at an alarm
	139	Automatic switchover frequency between inverter and commercial power-supply operation		139	Automatic switchover frequency from inverter to bypass operation
Backlash measures	140	Backlash acceleration stopping frequency	Backlash measures	140	Backlash acceleration stopping frequency
	141	Backlash acceleration stopping time		141	Backlash acceleration stopping time
	142	Backlash deceleration stopping frequency		142	Backlash deceleration stopping frequency
	143	Backlash deceleration stopping time		143	Backlash deceleration stopping time
-	144	Speed setting switchover	-	144	Speed setting switchover
PU	145	PU display language selection	PU	145	PU display language selection
Current detection	148	Stall prevention level at 0V input.	Current detection	148	Stall prevention level at 0V input
	149	Stall prevention level at 10V input.		149	Stall prevention level at 10V input
	150	Output current detection level		150	Output current detection level
	151	Output current detection signal delay time		151	Output current detection signal delay time
	152	Zero current detection level		152	Zero current detection level
	153	Zero current detection time		153	Zero current detection time
-	154	Voltage reduction selection during stall prevention operation	-	154	Voltage reduction selection during stall prevention operation
-	155	RT signal reflection time selection	-	155	RT signal function validity condition selection
-	156	Stall prevention operation selection	-	156	Stall prevention operation selection
-	157	OL signal output timer	-	157	OL signal output timer
-	158	AM terminal function selection	-	158	AM terminal function selection
-	159	Automatic switchover ON range between commercial power-supply and inverter operation	-	159	Automatic switchover frequency range from bypass to inverter operation
-	160	User group read selection	-	160	User group read selection
-	161	Frequency setting/key lock operation selection	-	161	Frequency setting/key lock operation selection
Automatic restart functions	162	Automatic restart after instantaneous power failure selection	Automatic restart functions	162	Automatic restart after instantaneous power failure selection
	163	First cushion time for restart		163	First cushion time for restart
	164	First cushion voltage for restart		164	First cushion voltage for restart
	165	Stall prevention operation level for restart		165	Stall prevention operation level for restart

FREQROL F700 Series			FREQROL A700 Series		
Function	Parameters	Name	Function	Parameters	Name
Current detection	166	Output current detection signal retention time	Current detection	166	Output current detection signal retention time
	167	Output current detection operation selection		167	Output current detection operation selection
Cumulative monitor clear	170	Cumulative power meter clear	Cumulative monitor clear	170	Watt-hour meter clear
	171	Operation hour meter clear		171	Operation hour meter clear
User group	172	User group registered display/batch clear	User group	172	User group registered display/batch clear
	173	User group registration		173	User group registration
	174	User group clear		174	User group clear
Input terminal function assignment	178	STF terminal function selection	input terminal function assignment	178	STF terminal function selection
	179	STR terminal function selection		179	STR terminal function selection
	180	RL terminal function selection		180	RL terminal function selection
	181	RM terminal function selection		181	RM terminal function selection
	182	RH terminal function selection		182	RH terminal function selection
	183	RT terminal function selection		183	RT terminal function selection
	184	AU terminal function selection		184	AU terminal function selection
	185	JOG terminal function selection		185	JOG terminal function selection
	186	CS terminal function selection		186	CS terminal function selection
	187	MRS terminal function selection		187	MRS terminal function selection
	188	STOP terminal function selection		188	STOP terminal function selection
189	RES terminal function selection	189	RES terminal function selection		
Output terminal function assignment	190	RUN terminal function selection	Output terminal function assignment	190	RUN terminal function selection
	191	SU terminal function selection		191	SU terminal function selection
	192	IPF terminal function selection		192	IPF terminal function selection
	193	OL terminal function selection		193	OL terminal function selection
	194	FU terminal function selection		194	FU terminal function selection
	195	ABC1 terminal function selection		195	ABC1 terminal function selection
196	ABC2 terminal function selection	196	ABC2 terminal function selection		
Multi-speed setting	232	Multi-speed setting (speeds 8)	Multi-speed setting	232	Multi-speed setting (speed 8)
	233	Multi-speed setting (speeds 9)		233	Multi-speed setting (speed 9)
	234	Multi-speed setting (speeds 10)		234	Multi-speed setting (speed 10)
	235	Multi-speed setting (speeds 11)		235	Multi-speed setting (speed 11)
	236	Multi-speed setting (speeds 12)		236	Multi-speed setting (speed 12)
	237	Multi-speed setting (speeds 13)		237	Multi-speed setting (speed 13)
	238	Multi-speed setting (speeds 14)		238	Multi-speed setting (speed 14)
	239	Multi-speed setting (speeds 15)		239	Multi-speed setting (speed 15)
-	240	Soft-PWM operation selection	-	240	Soft-PWM operation selection
-	241	Analog input display unit switchover	-	241	Analog input display unit switchover
-	242	Terminal 1 added compensation amount (terminal 2)	-	242	Terminal 1 added compensation amount (terminal 2)
-	243	Terminal 1 added compensation amount (terminal 4)	-	243	Terminal 1 added compensation amount (terminal 4)
-	244	Cooling fan operation selection	-	244	Cooling fan operation selection
Slip compensation	245	Rated slip	Slip compensation	245	Rated slip
	246	Slip compensation time constant		246	Slip compensation time constant
	247	Constant-output region slip compensation selection		247	Constant-power region slip compensation selection
-	250	Stop selection	-	250	Stop selection
-	251	Output phase failure protection selection	-	251	Output phase failure protection selection

A	Common Items
B	N:N Network
C	Parallel Link
D	Computer Link
E	Inverter Communication
F	Non-Protocol Communication (RS/RS2 Instruction)
G	Non-Protocol Communication (FX2N-232IF)
H	Programming Communication
I	Remote Maintenance

FREQROL F700 Series			FREQROL A700 Series		
Function	Parameters	Name	Function	Parameters	Name
Frequency compensation function	252	Override bias	Frequency compensation function	252	Override bias
	253	Override gain		253	Override gain
Life check	255	Life alarm status display	Life check	255	Life alarm status display
	256	Inrush current limit circuit life display		256	Inrush current limit circuit life display
	257	Control circuit capacitor life display		257	Control circuit capacitor life display
	258	Main circuit capacitor life display		258	Main circuit capacitor life display
	259	Main circuit capacitor life measuring		259	Main circuit capacitor life measuring
–	260	PWM frequency automatic switchover			
Power failure stop	261	Power failure stop selection	Power failure stop	261	Power failure stop selection
	262	Subtracted frequency at deceleration start		262	Subtracted frequency at deceleration start
	263	Subtraction starting frequency		263	Subtraction starting frequency
	264	Power-failure deceleration time 1		264	Power-failure deceleration time 1
	265	Power-failure deceleration time 2		265	Power-failure deceleration time 2
	266	Power failure deceleration time switchover frequency		266	Power failure deceleration time switchover frequency
–	267	Terminal 4 input selection	–	267	Terminal 4 input selection
–	268	Monitor decimal digits selection	–	268	Monitor decimal digits selection
–	–	–	–	270	Stop-on contact/load torque high speed frequency control selection
			Load torque high speed frequency control	271	High-speed setting maximum current
				272	Middle-speed setting minimum current
				273	Current averaging range
				274	Current averaging filter time constant
			Stop-on contact control	275	Stop-on contact excitation current lowspeed multiplying factor
				276	PWM carrier frequency at stop-on contact
			Brake sequence function	278	Brake opening frequency
				279	Brake opening current
				280	Brake opening current detection time
				281	Brake operation time at start
				282	Brake operation frequency
				283	Brake operation time at stop
				284	Deceleration detection function selection
			Droop control	285	Overspeed detection frequency (Speed deviation excess detection frequency)
				286	Droop gain
				287	Droop filter time constant
			–	288	Droop function activation selection
–	291	Pulse train I/O selection			
–	292	Automatic acceleration/deceleration			
–	293	Acceleration/deceleration separate selection			
–	294	UV avoidance voltage gain			
–	299	Rotation direction detection selection at restarting	–	299	Rotation direction detection selection at restarting

Function	FREQROL F700 Series		Function	FREQROL A700 Series				
	Parameters	Name		Parameters	Name			
Digital input	300	BCD input bias	-	-	-			
	301	BCD input gain						
	302	BIN input bias						
	303	BIN input gain						
	304	Digital input and analog input compensation enable/disable selection						
	305	Read timing operation selection						
Analog output	306	Analog output signal selection						
	307	Setting for zero analog output						
	308	Setting for maximum analog output						
	309	Analog output signal voltage/current switchover						
	310	Analog meter voltage output selection						
	311	Setting for zero analog meter voltage output						
	312	Setting for maximum analog meter voltage output						
Digital output	313	DO0 output selection						
	314	DO1 output selection						
	315	DO2 output selection						
	316	DO3 output selection						
	317	DO4 output selection						
	318	DO5 output selection						
	319	DO6 output selection						
Relay output	320	RA1 output selection						
	321	RA2 output selection						
	322	RA3 output selection						
Analog output	323	AM0 0V adjustment						
	324	AM1 0mA adjustment						
-	329	Digital input unit selection						
RS-485 communication	331	RS-485 communication station				RS-485 communication	331	RS-485 communication station number
	332	RS-485 communication speed					332	RS-485 communication speed
	333	RS-485 communication stop bit length					333	RS-485 communication stop bit length
	334	RS-485 communication parity check selection					334	RS-485 communication parity check selection
	335	RS-485 communication number of retries	335	RS-485 communication retry count				
	336	RS-485 communication check time interval	336	RS-485 communication check time interval				
	337	RS-485 communication waiting time setting	337	RS-485 communication waiting time setting				
	338	Communication operation command source	338	Communication operation command source				
	339	Communication speed command source	339	Communication speed command source				
	340	Communication startup mode selection	340	Communication startup mode selection				
	341	RS-485 communication CR/LF selection	341	RS-485 communication CR/LF selection				
	342	Communication EEPROM write selection	342	Communication EEPROM write selection				
	343	Communication error count	343	Communication error count				

A	Common Items
B	N:N Network
C	Parallel Link
D	Computer Link
E	Inverter Communication
F	Non-Protocol Communication (RS/RS2 Instruction)
G	Non-Protocol Communication (FX2N-232IF)
H	Programming Communication
I	Remote Maintenance

FREQROL F700 Series			FREQROL A700 Series		
Function	Parameters	Name	Function	Parameters	Name
DeviceNet	345	DeviceNet address	-	-	-
	346	DeviceNet baud rate			
CC-Link	349	Communication reset selection			
-	-	-	S-pattern acceleration/ deceleration C	380	Acceleration S-pattern 1
				381	Deceleration S-pattern 1
				382	Acceleration S-pattern 2
				383	Deceleration S-pattern 2
-	-	-	Pulse train input	384	Input pulse division scaling factor
				385	Frequency for 0 input pulse
				386	Frequency for maximum input pulse
LONWORKS	387	Initial communication delay time	-	-	-
	388	Send time interval at heart beat			
	389	Minimum sending time at heart beat			
	390	% setting reference frequency			
	391	Receive time interval at heart beat			
	392	Event driven detection width			
-	-	-	Second motor constants	450	Second applied motor
				451	Second motor control method selection
				453	Second motor capacity
				454	Number of second motor poles
				455	Second motor excitation current
				456	Rated second motor voltage
				457	Rated second motor frequency
				458	Second motor constant (R1)
				459	Second motor constant (R2)
				460	Second motor constant (L1)
				461	Second motor constant (L2)
				462	Second motor constant (X)
				463	Second motor auto tuning setting/ status
Remote output	495	Remote output selection	Remote output	495	Remote output selection
	496	Remote output data 1		496	Remote output data 1
	497	Remote output data 2		497	Remote output data 2
Communication error	500	Communication error execution waiting time	-	-	-
	501	Communication error occurrence count display			
	502	Stop mode selection at communication error			
Maintenance	503	Maintenance timer	Maintenance	503	Maintenance timer
	504	Maintenance timer alarm output set time		504	Maintenance timer alarm output set time
-	-	-	S-pattern acceleration/ deceleration D	516	S-pattern time at a start of acceleration
				517	S-pattern time at a completion of acceleration
				518	S-pattern time at a start of deceleration
				519	S-pattern time at a completion of deceleration

Function	FREQROL F700 Series		Function	FREQROL A700 Series	
	Parameters	Name		Parameters	Name
CC-Link	542	Communication station number (CC-Link)	-	-	-
	543	Baud rate (CC-Link)			
	544	CC-Link extended setting			
-	-	-	USB	547	USB communication station number
-	-	-		548	USB communication check time interval
Communication	549	Protocol selection	Communication	549	Protocol selection
	550	NET mode operation command source selection		550	NET mode operation command source selection
	551	PU mode operation command source selection		551	PU mode operation command source selection
Current average monitor	555	Current average time	Current average value monitor	555	Current average time
	556	Data output mask time		556	Data output mask time
	557	Current average value monitor signal output reference current		557	Current average value monitor signal output reference current
-	563	Energization time carrying-over times	-	563	Energization time carrying-over times
-	564	Operating time carrying-over times	-	564	Operating time carrying-over times
-	-	-	Second motor constants	569	Second motor speed control gain
-	571	Holding time at a start		-	571
-	-	-	-	574	Second motor online auto tuning
PID control	575	Output interruption detection time	PID control	575	Output interruption detection time
	576	Output interruption detection level		576	Output interruption detection level
	577	Output interruption release level		577	Output interruption cancel level
-	611	Acceleration time at a restart	-	611	Acceleration time at a restart

A	Common Items
B	N:N Network
C	Parallel Link
D	Computer Link
E	Inverter Communication
F	Non-Protocol Communication (RS/RS2 Instruction)
G	Non-Protocol Communication (FX2N-232IF)
H	Programming Communication
I	Remote Maintenance

FREQROL F700 Series			FREQROL A700 Series					
Function	Parameters	Name	Function	Parameters	Name			
-	-	-	-	684	Tuning data unit switchover			
			-	800	Control method selection			
			Torque command	803	Constant power range torque characteristic selection			
				804	Torque command source selection			
				805	Torque command value (RAM)			
				806	Torque command value (RAM,EEPROM)			
			Speed limit	807	Speed limit selection			
				808	Forward rotation speed limit			
				809	Reverse rotation speed limit			
			Torque limit	810	Torque limit input method selection			
				811	Set resolution switchover			
				812	Torque limit level (regeneration)			
				813	Torque limit level (3rd quadrant)			
				814	Torque limit level (4th quadrant)			
				815	Torque limit level 2			
				816	Torque limit level during acceleration			
				817	Torque limit level during deceleration			
			Easy gain tuning	818	Easy gain tuning response level setting			
				819	Easy gain tuning selection			
			Adjustment function	820	Speed control P gain 1			
				821	Speed control integral time 1			
				822	Speed setting filter 1			
				824	Torque control P gain 1			
				825	Torque control integral time 1			
				826	Torque setting filter 1			
				827	Torque detection filter 1			
				828	Model speed control gain			
				830	Speed control P gain 2			
				831	Speed control integral time 2			
				832	Speed setting filter2			
				834	Torque control P gain 2			
				835	Torque control integral time 2			
				836	Torque setting filter2			
				837	Torque detection filter 2			
			Additional function	849	Analog input off set adjustment			
				850	Control operation selection			
				858	Terminal 4 function assignment			
				859	Torque current			
				860	Second motor torque current			
				862	Notch filter time constant			
				863	Notch filter depth			
				864	Torque detection			
			865	Low speed detection				
			Indication function	866	Torque monitoring reference			
			-	867	AM output filter	-	867	AM output filter
			-	-	-	-	868	Terminal 1 function assignment

FREQROL F700 Series			FREQROL A700 Series		
Function	Parameters	Name	Function	Parameters	Name
-	872	Input phase failure protection selection	Protective Functions	872	Input phase failure protection selection
-	-	-		874	OLT level setting
	-	-		875	Fault definition
	-	-	Control system functions	877	Speed feed forward control/model adaptive speed control selection
	-	-		878	Speed feed forward filter
	-	-		879	Speed feed forward torque limit
	-	-		880	Load inertia ratio
Regeneration avoidance function	882	Regeneration avoidance operation selection	Regeneration avoidance function	882	Regeneration avoidance operation selection
	883	Regeneration avoidance operation level		883	Regeneration avoidance operation level
	884	Regeneration avoidance at deceleration detection sensitivity		884	Regeneration avoidance at deceleration detection sensitivity
	885	Regeneration avoidance compensation frequency limit value		885	Regeneration avoidance compensation frequency limit value
	886	Regeneration avoidance voltage gain		886	Regeneration avoidance voltage gain
Free parameter	888	Free parameter 1	Free parameters	888	Free parameter 1
	889	Free parameter 2		889	Free parameter 2
Energy saving monitor	891	Cumulative power monitor digit shifted times	Energy saving monitor	891	Cumulative power monitor digit shifted times
	892	Load factor		892	Load factor
	893	Energy saving monitor reference (motor capacity)		893	Energy saving monitor reference (motor capacity)
	894	Control selection during commercial power-supply operation		894	Control selection during commercial power-supply operation
	895	Power saving rate reference value		895	Power saving rate reference value
	896	Power unit cost		896	Power unit cost
	897	Power saving monitor average time		897	Power saving monitor average time
	898	Power saving cumulative monitor clear		898	Power saving cumulative monitor clear
	899	Operation time rate (estimated value)		899	Operation time rate (estimated value)
Calibration parameters	C0 (900)	FM terminal calibration	Calibration parameters	C0 (900)	FM terminal calibration
	C1 (901)	AM terminal calibration		C1 (901)	AM terminal calibration
	C2 (902)	Terminal 2 frequency setting bias frequency		C2 (902)	Terminal 2 frequency setting bias frequency
	C3 (902)	Terminal 2 frequency setting bias		C3 (902)	Terminal 2 frequency setting bias
	125 (903)	Terminal 2 frequency setting gain frequency		125 (903)	Terminal 2 frequency setting gain frequency
	C4 (904)	Terminal 2 frequency setting gain		C4 (904)	Terminal 2 frequency setting gain
	C5 (904)	Terminal 4 frequency setting bias frequency		C5 (904)	Terminal 4 frequency setting bias frequency
	C6 (904)	Terminal 4 frequency setting bias		C6 (904)	Terminal 4 frequency setting bias
	126 (905)	Terminal 4 frequency setting gain frequency		126 (905)	Terminal 4 frequency setting gain frequency
	C7 (905)	Terminal 4 frequency setting gain		C7 (905)	Terminal 4 frequency setting gain

A	Common Items
B	N:N Network
C	Parallel Link
D	Computer Link
E	Inverter Communication
F	Non-Protocol Communication (RS/RS2 Instruction)
G	Non-Protocol Communication (FX2N-232IF)
H	Programming Communication
I	Remote Maintenance

FREQROL F700 Series			FREQROL A700 Series		
Function	Parameters	Name	Function	Parameters	Name
-	-	-	Calibration parameters	C12 (917)	Terminal 1 bias frequency (speed)
				C13 (917)	Terminal 1 bias (speed)
				C14 (918)	Terminal 1 gain frequency (speed)
				C15 (918)	Terminal 1 gain (speed)
				C16 (919)	Terminal 1 bias command (torque/magnetic flux)
				C17 (919)	Terminal 1 bias (torque/magnetic flux)
				C18 (920)	Terminal 1 gain command (torque/magnetic flux)
				C19 (920)	Terminal 1 gain (torque/magnetic flux)
				C38 (932)	Terminal 4 bias command (torque/magnetic flux)
				C39 (932)	Terminal 4 bias (torque/magnetic flux)
				C40 (933)	Terminal 4 gain command (torque/magnetic flux)
				C41 (933)	Terminal 4 gain (torque/magnetic flux)
-	989	Parameter copy alarm release	-	-	-
PU	990	PU buzzer control	PU	990	PU buzzer control
	991	PU contrast adjustment		991	PU contrast adjustment

12.5.3 Communication parameters

The table below shows the parameters corresponding to each communication port.

- The PU port is common in the V500, F500, A500, and E500 Series.
- In the F700, and A700 Series, communication parameters for the built-in RS-485 terminal are provided.
- In the V500, F500, and A500 Series, communication parameters for the FR-A5NR computer link are provided.
- In the E500 Series, only the PU port is provided.
- In the S500 Series having the communication type in accordance with RS-485, the following parameters are applicable.

Function	FREQROL V500, F500, A500 and E500 Series (PU port)		FREQROL F700 and A700 Series (Built-in RS-485 terminal)		FREQROL V500, F500 and A500 Series (FR-A5NR computer link)		FREQROL S500 Series (Built-in port in accordance with RS-485)	
	Pr No.	Name	Pr No.	Name	Pr No.	Name	Pr No.	Name
Communication type	117	Communication station number	331	RS-485 communication station	331	Communication station number	n1 331	Communication station number
	118	Communication speed	332	RS-485 communication speed	332	Communication speed	n2 332	Communication speed
	119	Stop bit length/Data length	333	RS-485 communication stop bit length	333	Stop bit length/Data length	n3 333	Stop bit length/Data length
	120	Parity check presence/absence	334	RS-485 communication parity check selection	334	Parity check presence/absence	n4 334	Parity check presence/absence
	121	Number of communication retries	335	RS-485 communication number of retries	335	Number of communication retries	n5 335	Number of times of communication retries
	122	Communication check time interval	336	RS-485 communication check time interval	336	Communication check time interval	n6 336	Communication check time interval
	123	Waiting time setting	337	RS-485 communication waiting time setting	337	Waiting time setting	n7 337	Waiting time setting
	—	—	338	Communication operation command source	338	Operation command right	n8 338	Operation command right
	—	—	339	Communication speed command source	339	Speed command write	n9 339	Speed command right
	—	—	340	Communication startup mode selection	340	Link startup mode selection	n10 340	Link startup mode selection
	124	CR, LF presence/absence selection	341	RS-485 communication CR/LF selection	341	CR, LF presence/absence selection	n11 341	Absence/presence of CR and LF
	—	—	342	Communication EEPROM write selection	342	E ² PROM write selection	n12 342	E ² PROM write selection
	—	—	549	Protocol selection	—	—	—	—

A Common Items
B N:N Network
C Parallel Link
D Computer Link
E Inverter Communication
F Non-Protocol Communication (RS/RS2 Instruction)
G Non-Protocol Communication (FX2N-232IF)
H Programming Communication
I Remote Maintenance

MEMO

FX Series Programmable Controllers

User's Manual

[Non-Protocol Communication (RS/RS2 Instruction)]

Foreword

This manual explains the connections and programming procedures to use "non-protocol communication" provided in MELSEC-F FX Series Programmable Controllers and should be read and understood before attempting to install or use the unit.

Store this manual in a safe place so that you can take it out and read it whenever necessary. Always forward it to the end user.

This manual confers no industrial property rights or any rights of any other kind, nor does it confer any patent licenses. Mitsubishi Electric Corporation cannot be held responsible for any problems involving industrial property rights which may occur as a result of using the contents noted in this manual.

© 2005 MITSUBISHI ELECTRIC CORPORATION

A
Common Items

B
N:N Network

C
Parallel Link

D
Computer Link

E
Inverter Communication

F
Non-Protocol Communication (RS/RS2 Instruction)

G
Non-Protocol Communication (FX2N-232IF)

H
Programming Communication

I
Remote Maintenance

1. Outline

This chapter explains the outline of Non-protocol communication.

1.1 Outline of System

Non-protocol communication transfers non-protocol data using a printer, bar code reader, etc. In FX Series PLCs, non-protocol communication is applicable using RS and RS2 instructions. RS2 instructions are dedicated to FX3U and FX3UC PLCs, and allow communication using two channels at the same time when the channels are specified.

- 1) Up to 4096 points data can be sent, and up to 4096 points data can be received. However, make sure that the total number of sent and received data is 8000 points or less.
 - 2) Data transfer is enabled when a connected equipment supports non-protocol serial communication.
 - 3) The applicable total extension distance is 15m (49' 2") maximum in accordance with RS-232C communication, and 500m (1640' 5") maximum in accordance with RS-485 communication [50m (164' 0") when 485BD connection is used].
- RS instruction (FX2(FX), FX2C, FX0N, FX1S, FX1N, FX2N, FX3U, FX1NC, FX2NC, FX3UC)

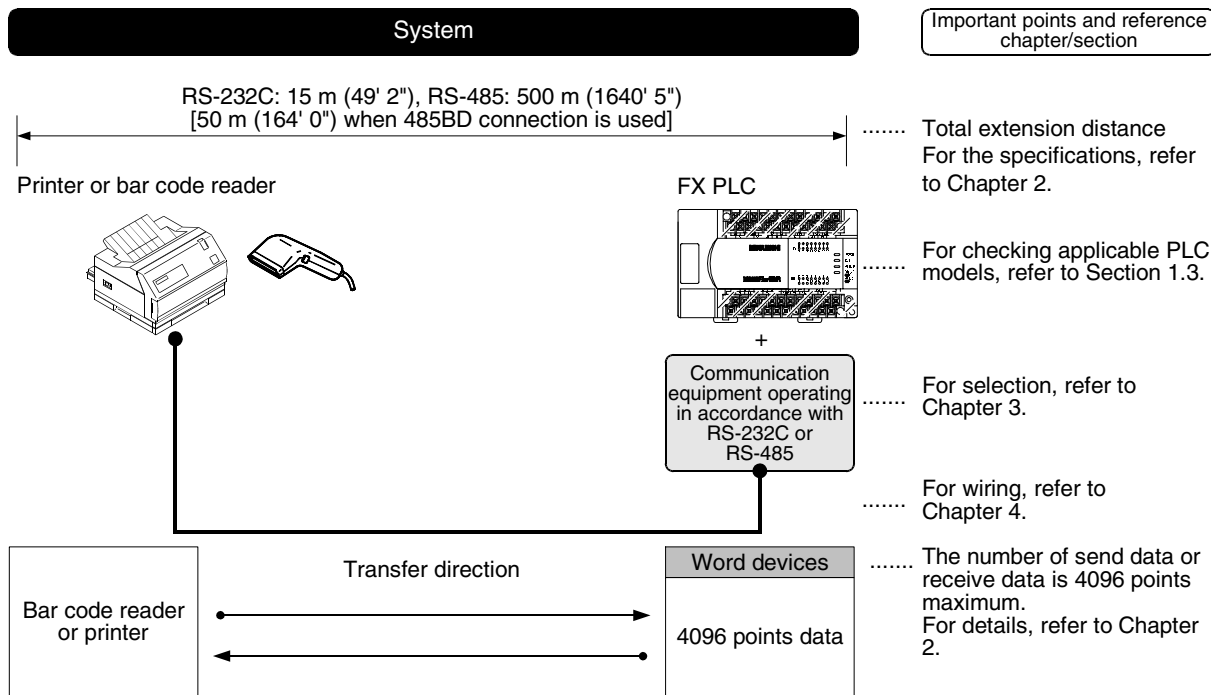

In PLCs except FX2N, FX3U, FX2NC and FX3UC PLCs, the number of send data or receive data is 256 points maximum.

A	Common Items
B	N:N Network
C	Parallel Link
D	Computer Link
E	Inverter Communication
F	Non-Protocol Communication (RS/RS2 Instruction)
G	Non-Protocol Communication (FX2N-232IF)
H	Programming Communication
I	Remote Maintenance

• RS2 instruction (FX3U and FX3UC)

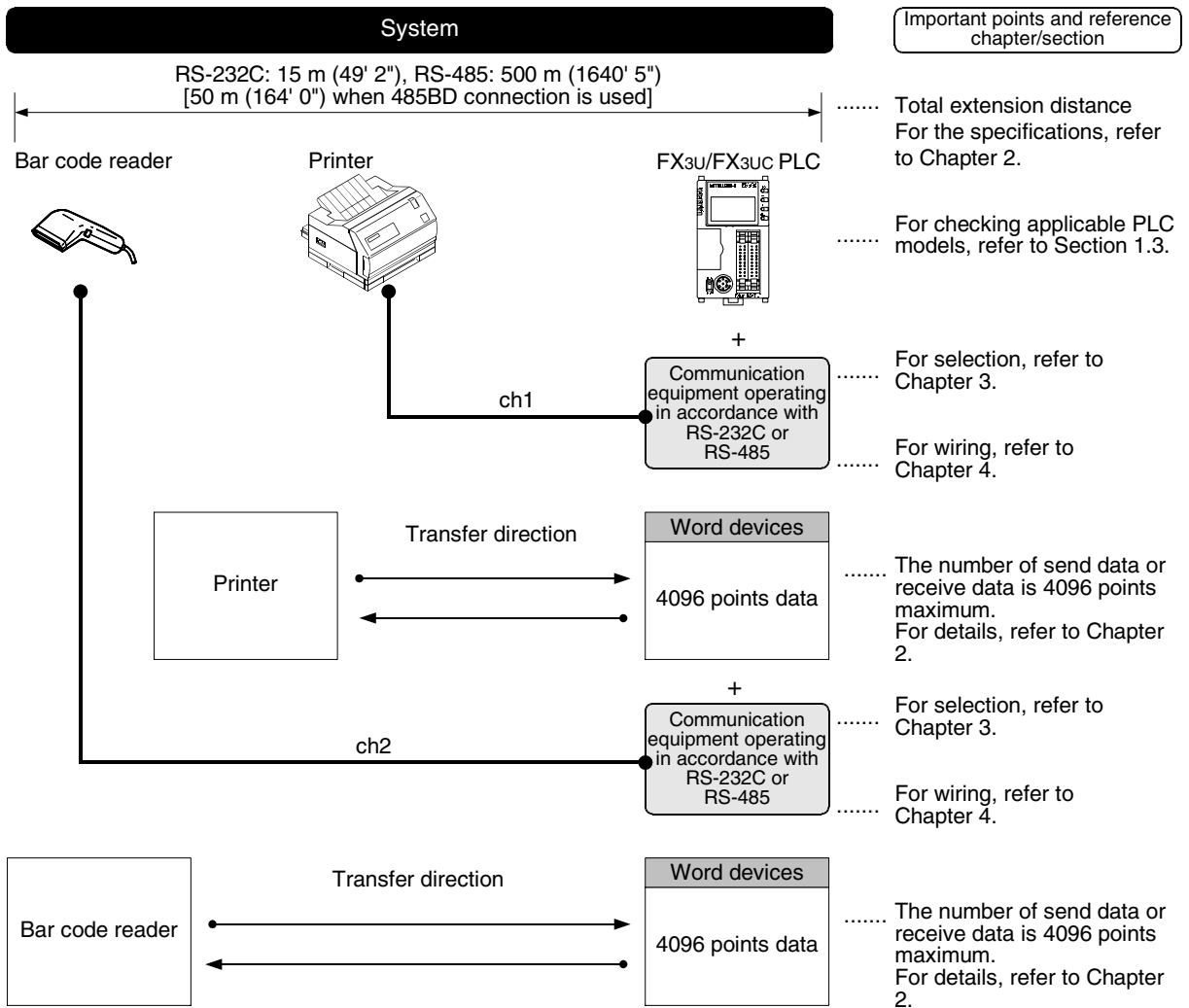

1.2 Major Procedures until Operation

The flow chart below shows the procedures for setting non-protocol communication until data transfer:

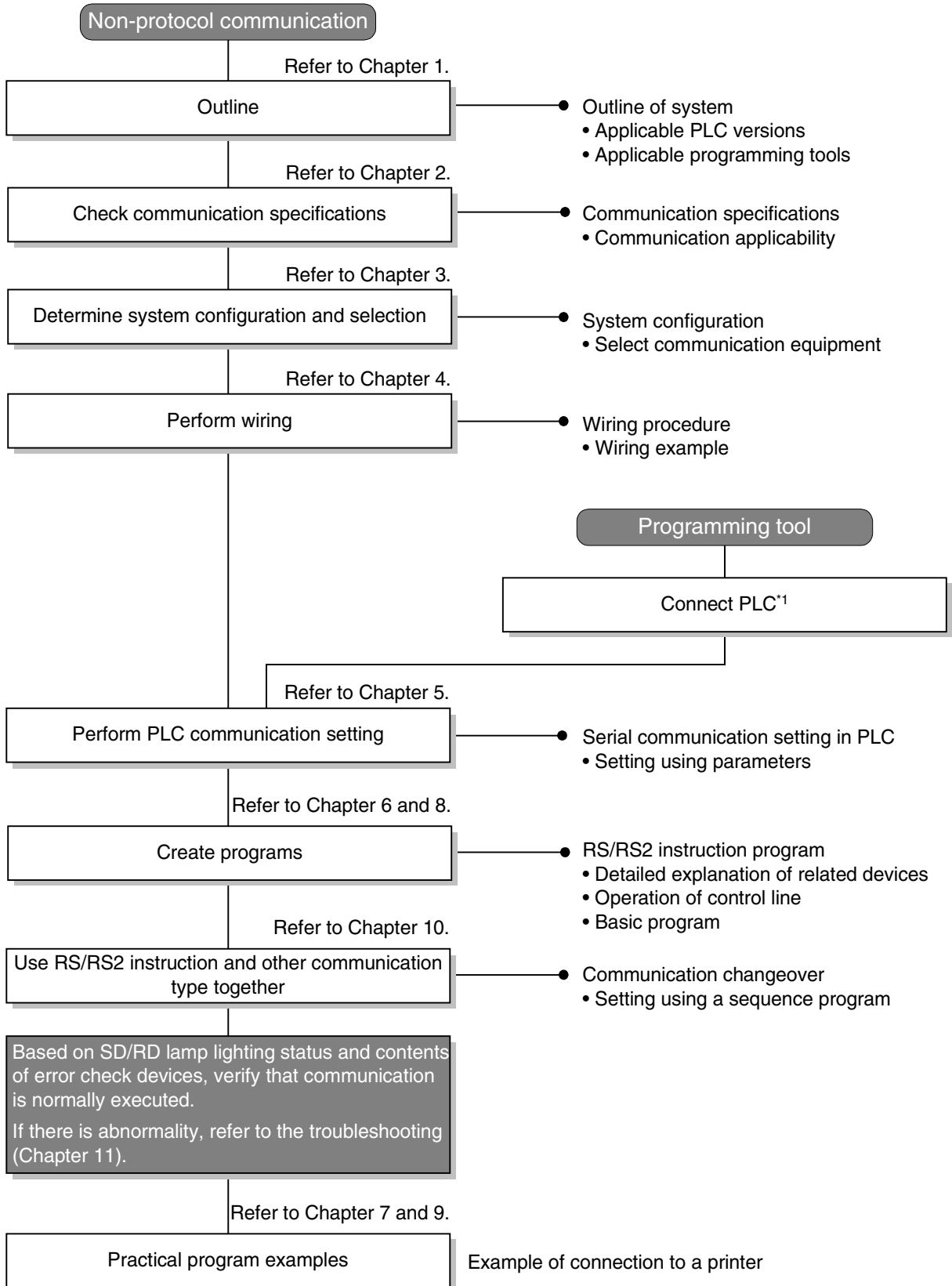

*1 For the method to connect a programming tool to a PLC, refer to the section "Programming Communication" in this manual or the manual of each programming tool.
 For details on operating procedures, refer to the manual of each programming tool.

A	Common Items
B	N:N Network
C	Parallel Link
D	Computer Link
E	Inverter Communication
F	Non-Protocol Communication (RS/RS2 Instruction)
G	Non-Protocol Communication (FX2N-232IF)
H	Programming Communication
I	Remote Maintenance

1.3 Communication Type Applicability in PLC

1.3.1 Applicable versions

The communication types are applicable in the following versions.

✓: Applicable (If applicable versions are limited, they are described inside ().)
 —: Not applicable

PLC	Applicability (applicable version)	Remarks
FX3UC Series	✓	Full-duplex communication/half-duplex communication
FX3U Series	✓	Full-duplex communication/half-duplex communication
FX2NC Series	✓	Full-duplex communication/half-duplex communication
FX2N Series	✓ (Ver. 1.06 or later)	Full-duplex communication (Ver. 2.00 or later)/half-duplex communication
FX1NC Series	✓	Half-duplex communication
FX1N Series	✓	Half-duplex communication
FX1S Series	✓	Half-duplex communication
FX0N Series	✓ (Ver. 1.20 or later)	Half-duplex communication
FX0s Series	—	Non-protocol communication is not provided
FX0 Series	—	Non-protocol communication is not provided
FX2c Series	✓	Half-duplex communication
FX2(FX) Series	✓ (Ver. 3.07 or later)*1	Half-duplex communication
FX1 Series	—	Non-protocol communication is not provided

*1. Applicable in products manufactured in January, 1994 (manufacturer's serial No.: 41****) and later.

1. Version check

The D8001(decimal) special data register contains information for determining the PLC version.

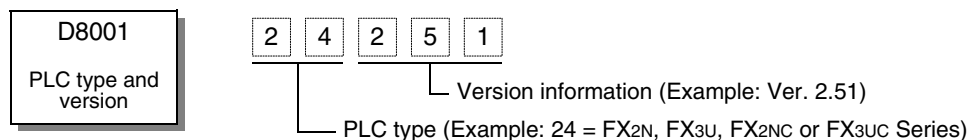

2. How to look at the manufacturer's serial number

The year and month of production of product can be seen from the Manufacturer's serial number "SERIAL" indicated on the label adhered to the right side of the product.

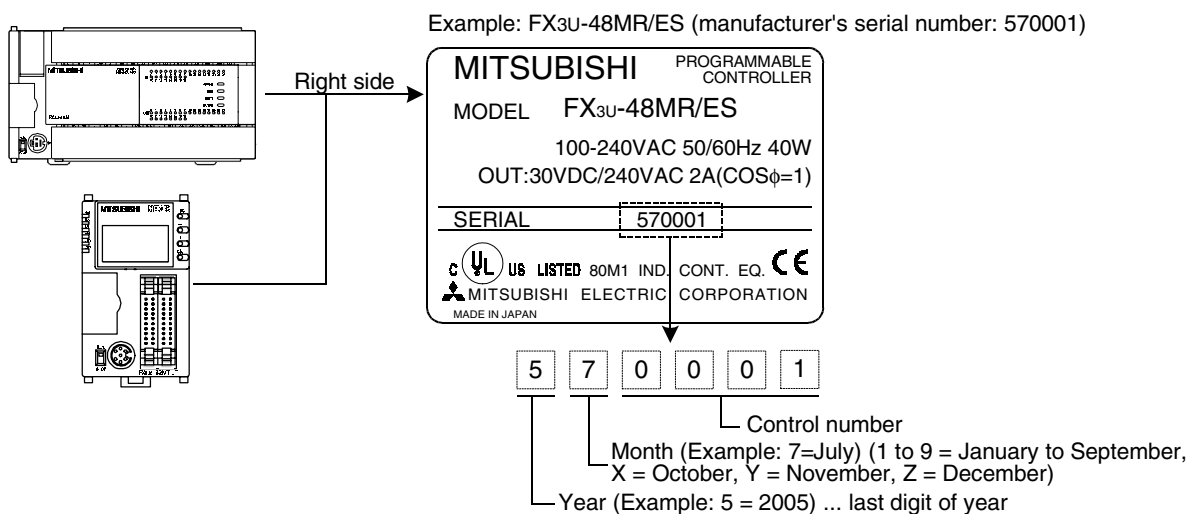

1.3.2 Products whose production was stopped

The table below shows series in which production of the main unit, communication equipment, etc. is stopped.

Use the description on system configuration, etc. in this manual for maintenance.

PLC	Date when production was stopped	Remarks
FX0 Series	June 30, 2002	Maintenance is offered within 7 years from the end of production (until June 30, 2009).
FX2c Series		
FX2(FX) Series		
FX1 Series		

1.4 Programming Tool Applicability

1.4.1 For applicable versions

The programming tool is applicable in each FX Series from the following version.

1. Japanese versions

✓: Applicable (If applicable versions are limited, they are described inside ().)
 —: Not applicable

Model name (Media model name is shown below)	Applicability (applicable version)	Remarks
FX3U and FX3UC PLCs		
GX Developer SW□D5C(F)-GPPW-J	✓ (Ver. SW8 P or later) Ver.8.13P	Select the model "FX3UC"
FX2N and FX2NC PLCs		
GX Developer SW□D5C(F)-GPPW-J	✓ (Ver. SW2 A or later)	Select the model "FX2N/FX2NC"
FX-PCS/WIN SW0PC-FXGP/WIN	✓ (Ver. 2.00 or later)	
FX-PCS-KIT/98 SW1PC-FXGP/98(-3,-5)	✓ (Ver. 4.00 or later)	
FX-PCS/98-3 SW1PC-FXGP/98-3	✓ (Ver. 4.00 or later)	
FX-PCS-KIT/V-3 SW1-PC-FXGP/V3	✓ (Ver. 2.00 or later)	
FX-A7PHP-KIT SW1RX-GPPFX	✓ (Ver. 3.00 or later)	
FX-20P(-SET0) FX-20P-MFXC	✓ (Ver. 4.00 or later)	
FX-10P(-SET0)	✓ (Ver. 3.00 or later)	
GOT-F900 Series display units F940WGOT-TWD F940GOT-*WD F940GOT-*BD-H F940GOT-*BD-RH	✓ (Refer to right column)	F940WGOT-TWD (Ver.1.00 or later) F940GOT-LWD, F940GOT-SWD (Ver.1.00 or later) F940GOT-LBD-H, F940GOT-SBD-H (Ver.1.00 or later) F940GOT-LBD-RH, F940GOT-SBD-RH (Ver.1.00 or later)

A	Common Items
B	N:N Network
C	Parallel Link
D	Computer Link
E	Inverter Communication
F	Non-Protocol Communication (RS/RS2 Instruction)
G	Non-Protocol Communication (FX2N-232IF)
H	Programming Communication
I	Remote Maintenance

Model name (Media model name is shown below)	Applicability (applicable version)	Remarks
FX1S, FX1N and FX1NC PLCs		
GX Developer SW□D5C(F)-GPPW-J	✓ (Ver. SW5 A or later)	Select the model "FX1S/FX1N"
FX-PCS/WIN SW0PC-FXGP/WIN	✓ (Ver. 4.00 or later)	
FX-PCS/98-3 SW1PC-FXGP/98-3	✓ (Ver. 5.00 or later)	
FX-20P(-SET0) FX-20P-MFXD	✓ (Ver. 5.00 or later)	
FX-10P(-SET0)	✓ (Ver. 4.00 or later)	
GOT-F900 Series display units F940WGOT-TWD F940GOT-*WD F940GOT-*BD-H F940GOT-*BD-RH	✓ (Refer to right column.)	F940WGOT-TWD (Ver. 1.00 or later) F940GOT-LWD, F940GOT-SWD (Ver. 1.00 or later) F940GOT-LBD-H, F940GOT-SBD-H (Ver. 1.00 or later) F940GOT-LBD-RH, F940GOT-SBD-RH (Ver. 1.00 or later)

2. English versions

✓: Applicable (If applicable versions are limited, they are described inside ().)
 —: Not applicable

Model name (Media model name is shown below)	Applicability (applicable version)	Remarks
FX3u and FX3UC PLCs		
GX Developer SW□D5C(F)-GPPW-E	✓ (Ver. SW8 P or later) Ver.8.13P	Select the model "FX3UC"
FX2N and FX2NC PLCs		
GX Developer SW□D5C(F)-GPPW-E	✓ (Ver. SW2 A or later)	Select the model "FX2N/FX2NC"
FX-PCS/WIN-E SW0PC-FXGP/WIN-E	✓ (Ver. 1.00 or later)	
FX-20P-E(-SET0) FX-20P-MFXC-E	✓ (Ver. 3.00 or later)	
FX-10P-E	✓ (Ver. 3.00 or later)	
GOT-F900 Series display units F940WGOT-TWD-E F940GOT-*WD-E F940GOT-*BD-H-E F940GOT-*BD-RH-E	✓ (Refer to right column)	F940WGOT-TWD-E (Ver. 1.00 or later) F940GOT-LWD-E, F940GOT-SWD-E (Ver. 1.00 or later) F940GOT-LBD-H-E, F940GOT-SBD-H-E (Ver. 1.00 or later) F940GOT-LBD-RH-E, F940GOT-SBD-RH-E (Ver. 1.00 or later)
FX1S, FX1N and FX1NC PLCs		
GX Developer SW□D5C(F)-GPPW-E	✓ (Ver. SW5 A or later)	Select the model "FX1S/FX1N"
FX-PCS/WIN-E SW0PC-FXGP/WIN-E	✓ (Ver. 3.00 or later)	
FX-20P-E(-SET0) FX-20P-MFXD-E	✓ (Ver. 4.00 or later)	
FX-10P-E	✓ (Ver. 4.00 or later)	
GOT-F900 Series display units F940WGOT-TWD-E F940GOT-*WD-E F940GOT-*BD-H-E F940GOT-*BD-RH-E	✓ (Refer to right column)	F940WGOT-TWD-E (Ver. 1.00 or later) F940GOT-LWD-E, F940GOT-SWD-E (Ver. 1.00 or later) F940GOT-LBD-H-E, F940GOT-SBD-H-E (Ver. 1.00 or later) F940GOT-LBD-RH-E, F940GOT-SBD-RH-E (Ver. 1.00 or later)

1.4.2 For non-applicable versions (setting an alternative model)

Even software not applicable to a PLC can make programs when an alternative model is set. In this case, however, programming is enabled only in the function ranges provided for instructions and program size in the alternative PLC model.

Model to be programmed	Model to be set	Priority: High → Low			
FX3UC Series	FX3UC	→	FX2N	→	FX2(FX)
FX3U Series	FX3U, FX3UC	→	FX2N	→	FX2(FX)
FX2NC Series	FX2NC, FX2N	→	FX2(FX)		
FX2N Series	FX2N	→	FX2(FX)		
FX1NC Series	FX1NC, FX1N	→	FX2N	→	FX2(FX)
FX1N Series	FX1N	→	FX2N	→	FX2(FX)
FX1S Series	FX1S	→	FX2(FX)		
FX0N Series	FX0N	→	FX2(FX)		
FX0S Series	FX0S	→	FX2(FX)		
FX0 Series	FX0	→	FX2(FX)		
FX2C Series	FX2C, FX2(FX)	→	FX2(FX)		
FX2(FX) Series	FX2(FX)	→	FX2(FX)		
FX1 Series	FX1				

A	Common Items
B	N:N Network
C	Parallel Link
D	Computer Link
E	Inverter Communication
F	Non-Protocol Communication (RS/RS2 Instruction)
G	Non-Protocol Communication (FX2N-232IF)
H	Programming Communication
I	Remote Maintenance

2. Specifications

This chapter explains the communication specifications and performance of non-protocol communication.

2.1 Communication Specifications (Reference)

Non-protocol communication is executed in the communication specifications shown in the table below.

Item	Specifications		Remarks
Transmission standard	RS-485 or RS-422 standard	RS-232C standard	
Maximum total extension distance	500 m (1640' 5") or less when using 485ADP 50 m (164' 0") or less when using 485BD —	15 m (49' 2") or less	
FX3UC Series			
FX3U Series			
FX2NC Series			
FX2N Series			
FX1NC Series			
FX1N Series			
FX1S Series			
FX0N Series			
FX2c Series			
FX2(FX) Series			
Protocol type	—		
Control procedure	Non-protocol communication		
Communication method	Half-duplex, bidirectional communication/ full-duplex, bidirectional communication		Adopted method varies depending on FX Series.
Baud rate	300, 600, 1200, 2400, 4800, 9600 or 19200 bps		
Character format			These items are set using parameters or using D8120, D8400 or D8420.
Start bit	—		
Data bit	7 or 8-bit		
Parity bit	None, odd or even		
Stop bit	1 or 2-bit		
Header	Provided or not provided		
Terminator	Provided or not provided		
Control line	—	Provided or not provided	
Sum check	Provided or not provided		Sum check is provided only in RS2 instruction.

2.2 Data Communication Specifications

2.2.1 Communication type applicability in PLC

1. Full-duplex communication

✓: Applicable (If applicable versions are limited, they are described inside ().)
 —: Not applicable

PLC Series	Applicability of communication in accordance with RS-485 (applicable version)	Applicability of communication in accordance with RS-232C (applicable version)
FX3UC Series	—	P
FX3U Series	—	P
FX2NC Series	—	P
FX2N Series	P (Ver. 2.00 or later) ^{*1}	P (Ver. 2.00 or later)
FX1NC Series	—	—
FX1N Series	—	—
FX1S Series	—	—
FX0N Series	—	—
FX0S Series	—	—
FX0 Series	—	—
FX2C Series	—	—
FX2(FX) Series	—	—

*1. Only the 485BD is applicable.
 Communication is applicable in products manufactured in November, 1994 (manufacturer's serial No.: 4Y****) and later.

2. Half-duplex communication

✓: Applicable (If applicable versions are limited, they are described inside ().)
 —: Not applicable

PLC Series	Applicability of communication in accordance with RS-485 (applicable version)	Applicability of communication in accordance with RS-232C (applicable version)
FX3UC Series	✓	✓
FX3U Series	✓	✓
FX2NC Series	✓	✓
FX2N Series	✓ (Ver. 1.06 or later)	✓ (Ver. 1.06 or later)
FX1NC Series	✓	✓
FX1N Series	✓	✓
FX1S Series	✓	✓
FX0N Series	✓ (Ver. 1.20 or later)	✓ (Ver. 1.20 or later)
FX0S Series	—	—
FX0 Series	—	—
FX2C Series	—	✓
FX2(FX) Series	—	✓ (Ver. 3.00 or later) ^{*2}

*2. Communication is applicable in products manufactured in November, 1994 (manufacturer's serial No.: 4Y****) and later.

A	Common Items
B	N:N Network
C	Parallel Link
D	Computer Link
E	Inverter Communication
F	Non-Protocol Communication (RS/RS2 Instruction)
G	Non-Protocol Communication (FX2N-232IF)
H	Programming Communication
I	Remote Maintenance

2.3 Number of Transfer Data

FX Series	Number of send/receive data	Remarks
FX3UC Series	0 to 4096 points	The total number of sent and received data should be 8000 points or less.
FX3U Series	0 to 4096 points	
FX2NC Series	0 to 4096 points	
FX2N Series	0 to 4096 points	
FX1NC Series	0 to 256 points	
FX1N Series	0 to 256 points	
FX1S Series	0 to 256 points	
FX0N Series	0 to 256 points	
FX0S Series	—	
FX0 Series	—	
FX2C Series	0 to 256 points	
FX2(FX) Series	0 to 256 points	

3. System Configuration and Selection

This chapter explains the system configuration and selection of communication equipment operating in accordance with RS-485 or RS-232C required by FX PLCs.

3.1 System Configuration

This section explains the outline of system configuration required to use non-protocol communication. Connect (optional) equipment operating in accordance with RS-485 or RS-232C to the FX PLC main unit.

1, **2** and **3** indicate the pattern types of combination of communication equipment.

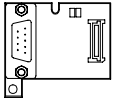
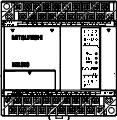
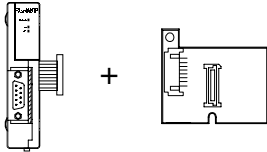
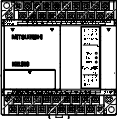
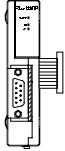
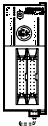
Communication equipment operating in accordance with RS-485 or RS-232C	FX PLC	Important point in selection	Total extension distance
<p>1</p>  <p>Communication board</p>		<p>Because it can be built inside a PLC, the installation area is not changed.</p>	<p>RS-485: 50 m (164' 0") RS-232C: 15 m (49' 2")</p>
<p>2</p>  <p>Communication adapter Special adapter connection board</p>		<p>Attach the special adapter connection board to the main unit, and then attach the communication adapter on the left side of the main unit.</p>	<p>RS-485: 500 m (1640' 5") RS-232C: 15 m (49' 2")</p>
<p>3</p>  <p>Communication adapter</p>		<p>Attach the communication adapter on the left side of the main unit.</p>	<p>RS-485: 500 m (1640' 5") RS-232C: 15 m (49' 2")</p>

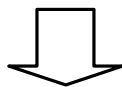

For combinations of communication equipment for each FX Series, refer to the next page.



A	Common Items
B	N:N Network
C	Parallel Link
D	Computer Link
E	Inverter Communication
F	Non-Protocol Communication (RS/RS2 Instruction)
G	Non-Protocol Communication (FX2N-232IF)
H	Programming Communication
I	Remote Maintenance

3.2 Applicable FX PLC and Communication Equipment

Select a combination of (optional) communication equipment, and put a check mark in the "Check" column. During selection, pay attention to the following:



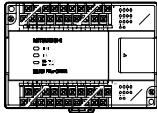

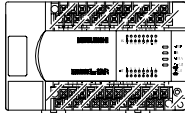

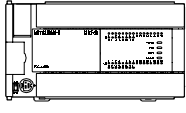
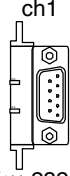
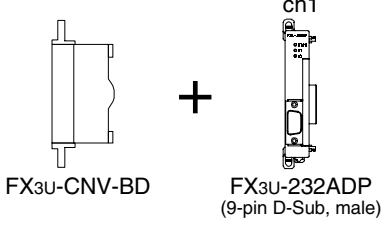
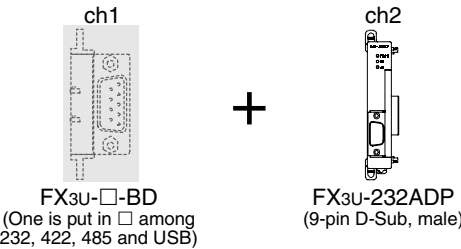
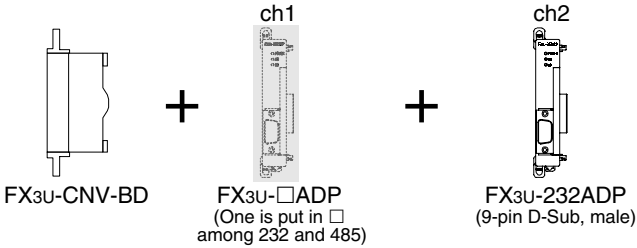
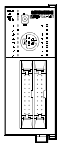
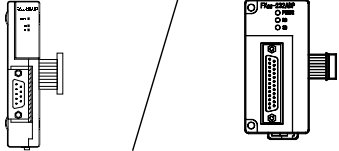
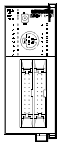
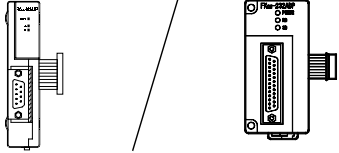

- Non-protocol communication is not provided in the FX0, FX0s, FX1 Series.

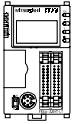
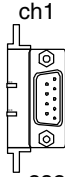
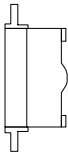
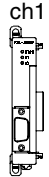
3.2.1 For communication in accordance with RS-232C

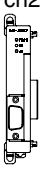
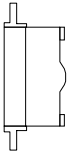

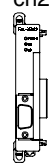
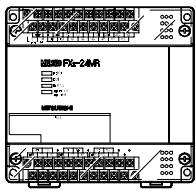

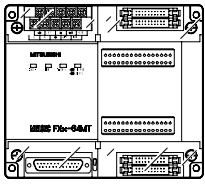
FX Series	Communication equipment (option)	Total extension distance	Check
 FX0N	 FX2NC-232ADP (9-pin D-Sub, male) / FX0N-232ADP (25-pin D-Sub, female)	15 m (49' 2")	
 FX1S	 FX1N-232-BD (9-pin D-Sub, male)	15 m (49' 2")	
	 FX1N-CNV-BD + FX2NC-232ADP (9-pin D-Sub, male) / FX1N-CNV-BD + FX0N-232ADP (25-pin D-Sub, female)	15 m (49' 2")	
 FX1N	 FX1N-232-BD (9-pin D-Sub, male)	15 m (49' 2")	
	 FX1N-CNV-BD + FX2NC-232ADP (9-pin D-Sub, male) / FX1N-CNV-BD + FX0N-232ADP (25-pin D-Sub, female)	15 m (49' 2")	
 FX2N	 FX2N-232-BD (9-pin D-Sub, male)	15 m (49' 2")	
	 FX2N-CNV-BD + FX2NC-232ADP (9-pin D-Sub, male) / FX2N-CNV-BD + FX0N-232ADP (25-pin D-Sub, female)	15 m (49' 2")	

FX Series	Communication equipment (option)	Total extension distance	Check
 <p>FX3U</p>	When using channel 1 (ch 1)		
	 <p>ch1 FX3U-232-BD (9-pin D-Sub, male)</p>	15 m (49' 2")	
	 <p>FX3U-CNV-BD + FX3U-232ADP (9-pin D-Sub, male)</p>	15 m (49' 2")	
	When using channel 2 (ch 2)		
	 <p>ch1 + ch2 FX3U-□-BD (One is put in □ among 232, 422, 485 and USB) + FX3U-232ADP (9-pin D-Sub, male)</p>	15 m (49' 2")	
	 <p>FX3U-CNV-BD + FX3U-□-ADP (One is put in □ among 232 and 485) + FX3U-232ADP (9-pin D-Sub, male)</p>	15 m (49' 2")	
 <p>FX1NC</p>	 <p>FX2NC-232ADP (9-pin D-Sub, male) / FX0N-232ADP (25-pin D-Sub, female)</p>	15 m (49' 2")	
 <p>FX2NC</p>	 <p>FX2NC-232ADP (9-pin D-Sub, male) / FX0N-232ADP (25-pin D-Sub, female)</p>	15 m (49' 2")	



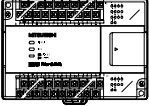
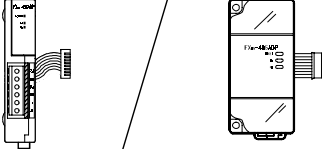

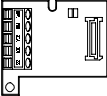

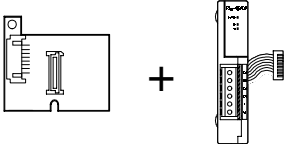
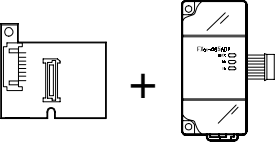
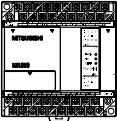
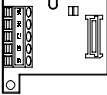
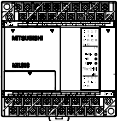
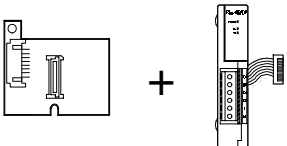
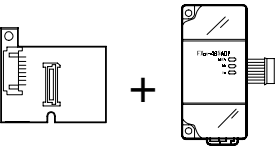
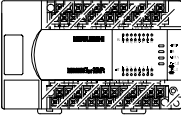
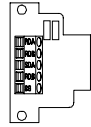
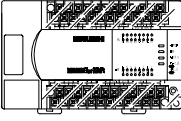
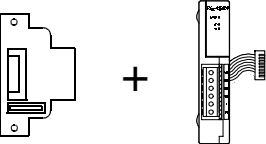
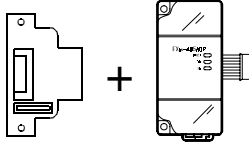
A	Common Items
B	N:N Network
C	Parallel Link
D	Computer Link
E	Inverter Communication
F	Non-Protocol Communication (RS/RS2 Instruction)
G	Non-Protocol Communication (FX2N-232IF)
H	Programming Communication
I	Remote Maintenance



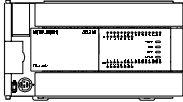
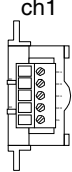

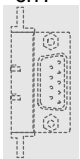
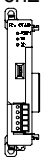
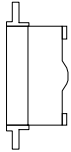
FX Series	Communication equipment (option)	Total extension distance	Check	
 <p>FX3UC</p>	<p>When using channel 1 (ch 1)</p>  <p>ch1 FX3U-232-BD (9-pin D-Sub, male)</p>	15 m (49' 2")		
	 <p>FX3U-CNV-BD</p> <p>+</p>  <p>ch1 FX3U-232ADP (9-pin D-Sub, male)</p>	15 m (49' 2")		
	<p>When using channel 2 (ch 2)</p>  <p>ch1 FX3U-□-BD (One is put in □ among 232, 422, 485 and USB)</p> <p>+</p>  <p>ch2 FX3U-232ADP (9-pin D-Sub, male)</p>	15 m (49' 2")		
	 <p>FX3U-CNV-BD</p> <p>+</p>  <p>ch1 FX3U-□-ADP (One is put in □ among 232 and 485)</p> <p>+</p>  <p>ch2 FX3U-232ADP (9-pin D-Sub, male)</p>	15 m (49' 2")		
	 <p>FX2(FX)</p>	 <p>FX-232ADP (25-pin D-Sub, female)</p>	15 m (49' 2")	
	 <p>FX2C</p>	 <p>FX-232ADP (25-pin D-Sub, female)</p>	15 m (49' 2")	

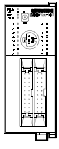
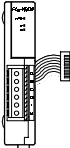
3.2.2 For communication in accordance with RS-485.

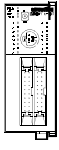
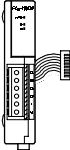
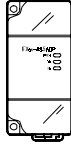
FX Series	Communication equipment (option)	Total extension distance	Check
 FX0N	 FX2NC-485ADP (European terminal block) / FX0N-485ADP (Terminal block)	500 m (1640' 5")	
 FX1S	 FX1N-485-BD (European terminal block)	50 m (164' 0")	
 FX1S	 +  FX1N-CNV-BD (European terminal block) / FX2NC-485ADP (European terminal block) / FX1N-CNV-BD (European terminal block) / FX0N-485ADP (Terminal block)	500 m (1640' 5")	
 FX1N	 FX1N-485-BD (European terminal block)	50 m (164' 0")	
 FX1N	 +  FX1N-CNV-BD (European terminal block) / FX2NC-485ADP (European terminal block) / FX1N-CNV-BD (European terminal block) / FX0N-485ADP (Terminal block)	500 m (1640' 5")	
 FX2N	 FX2N-485-BD	50 m (164' 0")	
 FX2N	 +  FX2N-CNV-BD (European terminal block) / FX2NC-485ADP (European terminal block) / FX2N-CNV-BD (European terminal block) / FX0N-485ADP (Terminal block)	500 m (1640' 5")	

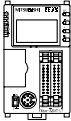
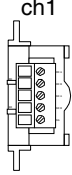
A	Common Items
B	N:N Network
C	Parallel Link
D	Computer Link
E	Inverter Communication
F	Non-Protocol Communication (RS/RS2 Instruction)
G	Non-Protocol Communication (FX2N-232IF)
H	Programming Communication
I	Remote Maintenance

FX Series	Communication equipment (option)	Total extension distance	Check	
When using channel 1 (ch 1)				
 <p>FX3U</p>	 <p>ch1</p> <p>FX3U-485-BD (European terminal block)</p>	50 m (164' 0")		
	 <p>FX3U-CNV-BD</p> <p>+</p>  <p>ch1</p> <p>FX3U-485ADP (European terminal block)</p>	500 m (1640' 5")		
	When using channel 2 (ch 2)			
	 <p>ch1</p> <p>FX3U-□-BD (One is put in □ among 232, 422, 485, and USB).</p> <p>+</p>  <p>ch2</p> <p>FX3U-485ADP (European terminal block)</p>	500 m (1640' 5")		
 <p>FX3U-CNV-BD</p> <p>+</p>  <p>ch1</p> <p>FX3U-□ADP (One is put in □ among 232 and 485).</p> <p>+</p>  <p>ch2</p> <p>FX3U-485ADP (European terminal block)</p>	500 m (1640' 5")			
 <p>FX1NC</p>	 <p>FX2NC-485ADP (European terminal block)</p> <p>/</p>  <p>FX0N-485ADP (Terminal block)</p>	500 m (1640' 5")		
 <p>FX2NC</p>	 <p>FX2NC-485ADP (European terminal block)</p> <p>/</p>  <p>FX0N-485ADP (Terminal block)</p>	500 m (1640' 5")		

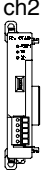
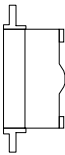
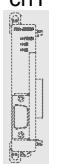
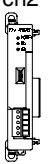
FX Series	Communication equipment (option)	Total extension distance	Check
 <p>FX3UC</p>	When using channel 1 (ch 1)		
	 <p>ch1</p> <p>FX3U-485-BD (European terminal block)</p>	<p>50 m (164' 0")</p>	
	 <p>FX3U-CNV-BD</p> <p>+</p>  <p>ch1</p> <p>FX3U-485ADP (European terminal block)</p>	<p>500 m (1640' 5")</p>	
	When using channel 2 (ch 2)		
	 <p>ch1</p> <p>FX3U-□-BD (One is put in □ among 232, 422, 485, and USB).</p> <p>+</p>  <p>ch2</p> <p>FX3U-485ADP (European terminal block)</p>	<p>500 m (1640' 5")</p>	
	 <p>FX3U-CNV-BD</p> <p>+</p>  <p>ch1</p> <p>FX3U-□-ADP (One is put in □ among 232 and 485).</p> <p>+</p>  <p>ch2</p> <p>FX3U-485ADP (European terminal block)</p>	<p>500 m (1640' 5")</p>	

A	Common Items
B	N:N Network
C	Parallel Link
D	Computer Link
E	Inverter Communication
F	Non-Protocol Communication (RS/RS2 Instruction)
G	Non-Protocol Communication (FX2N-232IF)
H	Programming Communication
I	Remote Maintenance

4. Wiring

This chapter explains the wiring.

WIRING PRECAUTIONS



DANGER

- Cut off all phases of the power source externally before installation or wiring work in order to avoid electric shock or damage of product.
- Make sure to attach the terminal cover offered as an accessory to the product before turning on the power or starting the operation after installation or wiring work.
Failure to do so may cause electric shock.

WIRING PRECAUTIONS



CAUTION

- Make sure to observe the precautions below in order to prevent any damage to the machine or any accident which may be caused by abnormal data written to the PLC due to the influence of noise:
 - 1) Do not lay close or bundle with the main circuit line, high-voltage line, or load line.
Otherwise, effects of noise or surge induction are likely to take place.
Keep a safe distance of least 100 mm (3.94") from the above lines during wiring.
 - 2) Ground the shield wire or shield of a shielded cable at one point on the PLC. However, do not ground at the same point as high voltage lines.
- Perform wiring properly to the FX0N/FX2N Series extension equipment of the terminal block type in accordance with the precautions below.
Failure to do so may cause electric shock, short-circuit, wire breakage, or damages to the product.
 - The disposal size of the cable end should follow the dimensions described in this manual.
 - Tightening torque should follow the torque described in this manual.
- Observe the following items to wire the lines to the European terminal board. Ignorance of the following items may cause electric shock, short circuit, disconnection, or damage of the product.
 - The disposal size of the cable end should follow the dimensions described in this manual.
 - Tightening torque should follow the torque described in this manual.
 - Twist the end of strand wire and make sure there is no loose wires.
 - Do not solder-plate the electric wire ends.
 - Do not connect electric wires of unspecified size or beyond the specified number of electric wires.
 - Fix the electric wires so that the terminal block and connected parts of electric wires are not directly stressed.

4.1 Wiring Procedure

1 Preparing for wiring

Prepare cables and terminal resistors required in the wiring.

→ For details, refer to Section 4.2.

2 Turning OFF the PLC power

Before starting the wiring work, make sure that the PLC power is OFF.

3 Connecting the power supply (only the FX0N-485ADP)

Connect the power supply to the 24V DC power terminal.

4 Wiring communication equipment

Connect communication equipment operating in accordance with RS-485 or RS-232C.

→ For details, refer to Section 4.3.

4.2 Selecting Cables and Terminal Resistors

Select cables using the procedure described below.

4.2.1 Twisted pair cable

Use twisted pair cables for connecting communication equipment operating in accordance with RS-485. The table below shows recommended model names and manufacturers of cables used in wiring.

1. Recommended cables

Manufacturer	Model name	Remarks
Mitsubishi Cable Industries, Ltd.	SPEV(SB)-0.2-2P	Two-pair cable of 0.2 mm ²
	SPEV(SB)-MPC-0.2 × 3P	Three-pair cable of 0.2 mm ²
	SPEV(SB)-0.5-2P	Two-pair cable of 0.5 mm ²
Showa Electric Wire & Cable Co., Ltd.	KMPEV-SB CWS-178 0.2SQ × 2P	Two-pair cable of 0.2 mm ²
	KMPEV-SB CWS-178 0.5SQ × 2P	Two-pair cable of 0.5 mm ²
Sumitomo Electric Industries, Ltd.	DPEV SB 0.3 × 3P	Three-pair cable of 0.3 mm ²
	DPEV SB 0.5 × 3P	Three-pair cable of 0.5 mm ²
The Furukawa Electric Co., Ltd.	D-KPEV-SB 0.2 × 3P	Three-pair cable of 0.2 mm ²
	D-KPEV-SB 0.5 × 3P	Three-pair cable of 0.5 mm ²
Fujikura Ltd.	IPEV-SB 2P × 0.3 mm ²	Two-pair cable of 0.3 mm ²
	IPEV-SB 2P × 0.5 mm ²	Two-pair cable of 0.5 mm ²

2. Cable structural drawing (reference)

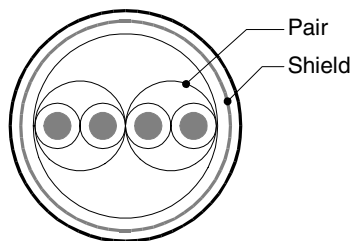

Example of two-pair cable structural drawing

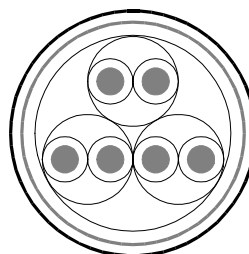

Example of three-pair cable structural drawing

4.2.2 Connecting cables

1. European type terminal block

Use shielded twisted pair cables for connecting communication equipment operating in accordance with RS-485.

The table below shows applicable cables and tightening torque.

	Cable size when one cable is connected	Cable size when two cables are connected	Cable size for bar terminal with insulating sleeve	Tightening torque	Tool size	
					A	B
FX3U-485-BD FX3U-485ADP	AWG22 to AWG20	AWG22	AWG22 to AWG20	0.22 to 0.25 N·m	0.4 (0.01")	2.5 (0.09")
FX2N-485-BD FX1N-485-BD	AWG26 to AWG16		—	0.6 N·m	0.6 (0.03")	3.5 (0.14")
FX2NC-485ADP	AWG26 to AWG16	AWG26 to AWG20	—	0.4 to 0.5 N·m	0.6 (0.03")	3.5 (0.14")

With regard to the cable end treatment, treat a stranded cable or solid cable as it is, or use a bar terminal with an insulating sleeve.

- When treating a stranded cable or solid cable as it is
 - Twist the end of a stranded cable so that wires don't get barbed.
 - Do not plate the end of a cable.

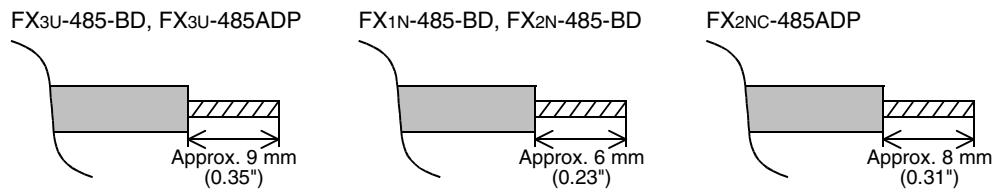

- When using a bar terminal with an insulating sleeve
 Because it is difficult to insert a cable into an insulating sleeve depending on the cable sheath thickness, select a proper cable according to the outline drawing.

Manufacturer	Model name	Caulking tool
Phoenix Contact	AI 0.5-8WH	CRIMPFOX UD6

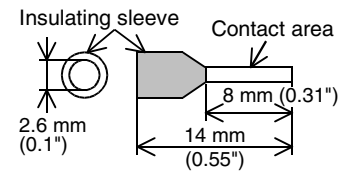

- Tool
 - When tightening a terminal on the European terminal block, use a small commercial screwdriver with straight shape whose tip is not wide as shown in the right figure.

Manufacturer	Model name
Phoenix Contact	SZS 0.4 × 2.5

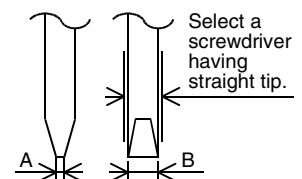

For the size A and size B, refer to the above table.

2. Terminal block

In the FX0N-485ADP and FX-485ADP, the terminal screw size is "M3".

Make sure to use a crimp-style terminal with the following sizes.

Make sure that the tightening torque is 0.5 to 0.8 N·m.

- When wiring one cable to one terminal

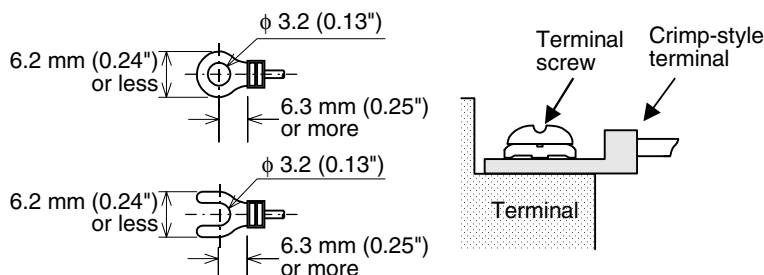

- When wiring two cables to one terminal

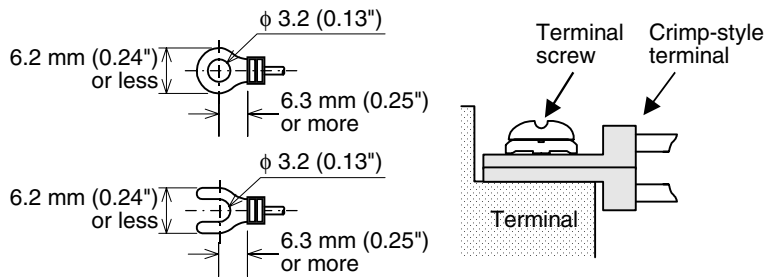

4.2.3 Connecting terminal resistors

Make sure to provide a terminal resistor at each end of a line.
 In the case of one-pair wiring, connect a terminal resistor to the RDA-RDB signal terminal in the communication equipment.
 In the case of two-pair wiring, connect a terminal resistor to the RDA-RDB signal terminal and SDA-SDB terminal in the communication equipment.

1. Terminal resistor type

In the case of one-pair wiring, use two terminal resistors of 110 Ω, 1/2 W.
 In the case of two-pair wiring, use four terminal resistors of 330 Ω, 1/4 W.
 Among terminal resistors supplied together with the communication equipment, select ones having the color codes shown to the right.

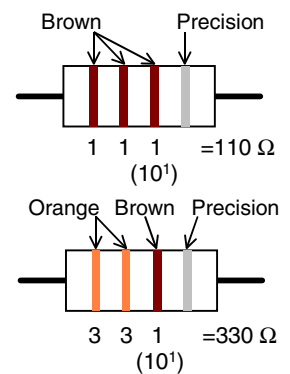

2. When using the FX3U-485-BD or FX3U-485ADP

The FX3U-485-BD and FX3U-485ADP have a built-in terminal resistor.
 Set the terminal resistor selector switch accordingly.

- FX3U-485-BD

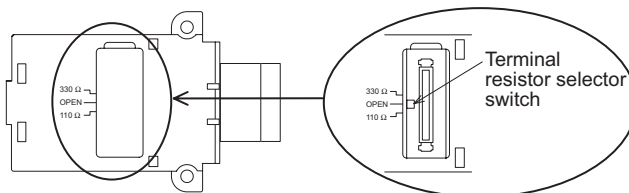

- FX3U-485ADP

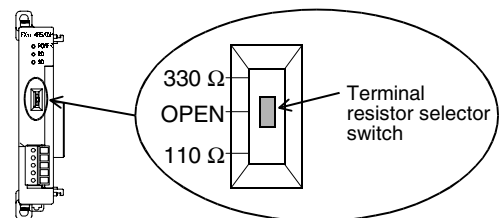

A	Common Items
B	N:N Network
C	Parallel Link
D	Computer Link
E	Inverter Communication
F	Non-Protocol Communication (RS/RS2 Instruction)
G	Non-Protocol Communication (FX2N-232IF)
H	Programming Communication
I	Remote Maintenance

4.3 Connection Diagram

4.3.1 Connector pin arrangement in communication equipment operating in accordance with RS-232C

FX-232ADP		FX0N-232ADP		FX1N-232-BD, FX2N-232-BD FX2NC-232ADP, FX3U-232-BD FX3U-232ADP		Signal name	Function
25-pin D-Sub (female) connector		25-pin D-Sub (female) connector		9-pin D-Sub (male) connector			
	8		—		1 ^{*1}	CD (DCD)	Receive carrier detection
	3		3		2	RD (RXD)	Receive data input
	2		2		3	SD (TXD)	Send data output
	20		20		4	ER (DTR)	Data terminal ready
	7		7		5	SG (GND)	Signal ground
	6		6		6	DR (DSR)	Data set ready
	1		—		—	FG	Frame ground

*1. The FX2NC-232ADP does not use the CD (DCD) signal.

4.3.2 Wiring for communication in accordance with RS-232C

Representative wiring examples are shown in this subsection. When pin numbers in the counterpart equipment are different, wire the pins as shown below.

1. When connected equipment has the terminal specifications

PLC					External equipment operating in accordance with RS-232C					
Name	9-pin D-Sub (female) connector		25-pin D-Sub (male) connector		CS, RS		Name	DR, ER		
	FX3U-232-BD FX2N-232-BD FX1N-232-BD FX3U-232ADP	FX2NC-232ADP	FX0N-232ADP	FX-232ADP	9-pin D-Sub	25-pin D-Sub		9-pin D-Sub	25-pin D-Sub	
FG	—			1	FG	—	1	FG	—	1
RD(RXD)	2		3		RD(RXD)	2	3	RD(RXD)	2	3
SD(TXD)	3		2		SD(TXD)	3	2	SD(TXD)	3	2
ER(DTR) *1	4		20		RS(RTS)	7	4	ER(DTR)	4	20
SG(GND)	5		7		SG(GND)	5	7	SG(GND)	5	7
DR(DSR) *1	6		6		CS(CTS)	8	5	DR(DSR)	6	6

*1. When the control line is not used, wiring is not required for this signal.
 Because the interlink mode (provided only in FX2N, FX3U, FX2NC, and FX3UC PLCs) uses the control line, wiring is required for this signal.

2. When connected equipment has the modem specifications

PLC					External equipment operating in accordance with RS-232C					
Name	9-pin D-Sub (female) connector		25-pin D-Sub (male) connector		CS, RS		Name	DR, ER		
	FX3U-232-BD FX2N-232-BD FX1N-232-BD FX3U-232ADP	FX2NC-232ADP	FX0N-232ADP	FX-232ADP	9-pin D-Sub	25-pin D-Sub		9-pin D-Sub	25-pin D-Sub	
FG	—			1	FG	—	1	FG	—	1
CD(DCD)	1	—		8	CD(DCD)	1	8	CD(DCD)	1	8
RD(RXD)	2		3		RD(RXD)	2	3	RD(RXD)	2	3
SD(TXD)	3		2		SD(TXD)	3	2	SD(TXD)	3	2
ER(DTR)	4		20		RS(RTS)	7	4	ER(DTR)	4	20
SG(GND)	5		7		SG(GND)	5	7	SG(GND)	5	7
DR(DSR)	6		6		CS(CTS)	8	5	DR(DSR)	6	6

• The FX0N-232ADP and FX2NC-232ADP do not use the CD (DCD) signal.

4.3.3 Wiring for communication in accordance with RS-485

One-pair wiring and two-pair wiring (for FS-422) are applicable in communication in accordance with RS-485. Perform proper wiring according to the counterpart equipment.

4.3.4 One-pair wiring

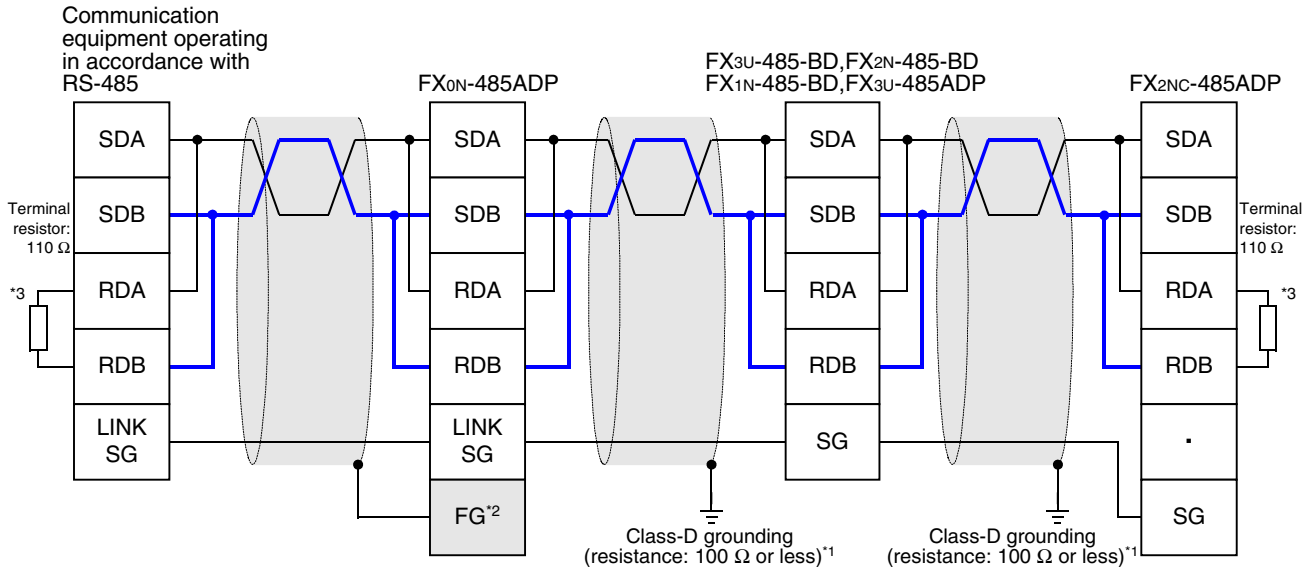

- *1 Make sure to perform Class-D grounding to the shield of a twisted pair cable connected to the FX2N-485-BD, FX1N-485-BD, FX3U-485-BD, FX2NC-485ADP or FX3U-485ADP.
- *2 Make sure to connect the **FG** terminal to the (grounding) terminal in the PLC requiring Class-D grounding. If the grounding terminal is not provided in the PLC, directly perform Class-D grounding.
- *3 Make sure to provide a terminal resistor at each end of a line.
 - The FX3U-485-BD and FX3U-485ADP have a built-in terminal resistor. Set the terminal resistor selector switch accordingly.
 - The FX0N-485ADP, FX2NC-485ADP, FX2N-485-BD and FX1N-485-BD are supplied together with terminal resistors.
- When the FX2N-485-BD is used, echo transfer is generated because the FX2N-485-BD adopts full-duplex interface.

4.3.5 Two-pair wiring

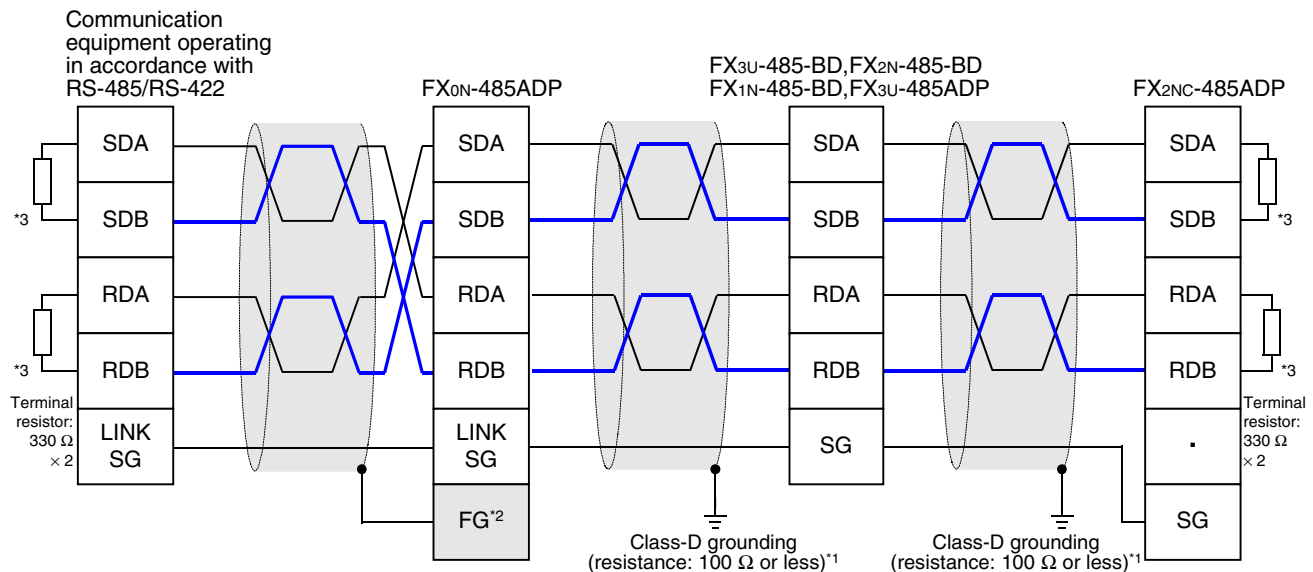

- *1 Make sure to perform Class-D grounding to the shield of a twisted pair cable connected to the FX2N-485-BD, FX1N-485-BD, FX3U-485-BD, FX2NC-485ADP or FX3U-485ADP.
- *2 Make sure to connect the **FG** terminal to the (grounding) terminal in the PLC requiring Class-D grounding. If the grounding terminal is not provided in the PLC, directly perform Class-D grounding.
- *3 Make sure to provide a terminal resistor at each end of a line.
 - The FX3U-485-BD and FX3U-485ADP have a built-in terminal resistor. Set the terminal resistor selector switch accordingly.
 - The FX0N-485ADP, FX2NC-485ADP, FX2N-485-BD and FX1N-485-BD are supplied together with terminal resistors.

A	Common Items
B	N:N Network
C	Parallel Link
D	Computer Link
E	Inverter Communication
F	Non-Protocol Communication (RS/RS2 Instruction)
G	Non-Protocol Communication (FX2N-232IF)
H	Programming Communication
I	Remote Maintenance

4.4 Grounding

Grounding should be performed as stated below.

- The grounding resistance should be 100Ω or less.
- Independent grounding should be performed for best results.
When independent grounding can not be performed, perform "shared grounding" as shown in the following figure.

→ For details, refer to the Hardware Edition of each series.

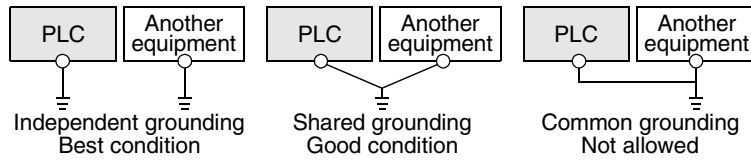

- The grounding wire size should be AWG 14 (2 mm²) or larger.
- The grounding point should be close to the PLC, and all grounding wires should be as short as possible.

5. Communication Setting in FX Programmable Controller

This chapter explains the communication setting types and setting methods for non-protocol communication using RS instruction.

5.1 Communication Setting Method Mechanism

This section explains the communication setting method types and setting contents reflection methods in FX PLCs.

1. Setting method types

- 1) Specifying the setting using parameters.
 Register the setting as parameters by executing communication setting on the personal computer screen using the sequence programming software, and transfer them to a PLC.
 (This method using parameters is not available in FX2(FX), FX2C, and FX0N PLCs.)
- 2) Specifying the settings by writing data to special data registers
 Prepare a sequence program which sets the communication format and timeout determination time, and then transfer the program to the PLC.

Caution

A PLC operates in the same way without regard to a selected method shown above. If both methods are selected, priority is given to the method using parameters.

2. Communication setting method applicability in each FX Series

FX Series	Specification using parameters	Specification by writing settings data to special data registers
FX1S, FX1N, FX2N, FX3U, FX1NC, FX2NC, FX3UC	✓ (Recommended)	✓
FX0N, FX2(FX), FX2C	—	✓

3. Setting data flow

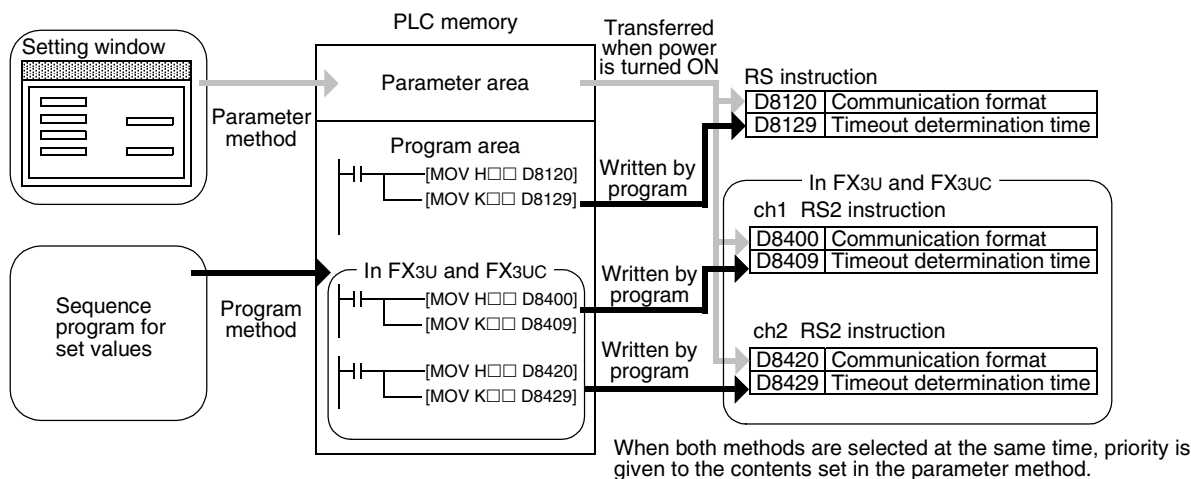

4. Timing at which the settings becomes valid

- 1) When specifying the settings by parameters
 When the PLC power is turned ON, the contents of parameters set on the parameter setting window using sequence programming software are automatically transferred to D8120, D8129, D8400, D8409, D8420 and D8429 in the PLC.
 As soon as the parameters are transferred to the PLC, the settings becomes valid.
 After the programs (parameters) are transferred to the PLC, it is necessary to turn OFF the PLC power once, and then turn it ON again.

- 2) When specifying the settings by writing data to special data registers
 After writing a sequence program, set the PLC mode from STOP to RUN to write the preset data to D8120, D8400 or D8420. After that, set the PLC mode to STOP once, and then set it to RUN again. Or turn OFF the PLC power once, and then turn it ON again.
 As soon as the PLC mode is set to RUN from STOP or the PLC power is turned ON from OFF, the settings becomes valid.

5.2 Communication Setting in Parameter Method (GX Developer)

Two software packages, GX Developer and FXGP/WIN for Windows, are available in the parameter method. This section explains the parameter method using GX Developer.

5.2.1 Operating procedure

This subsection explains the serial communication setting method. Suppose that GX Developer is already started up.

1 Opening the parameter setting window

Double-click [Parameter]-[PLC parameter] from the project tree.

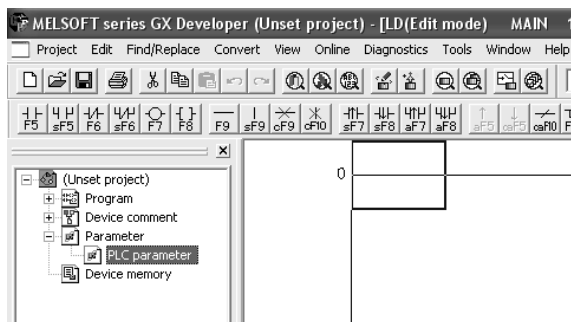

If the project tree is not displayed, select [View] - [Project data list] from the tool menu.

2 Setting the serial communication (parameters)

Click the [PLC system(2)] tab in the dialog box

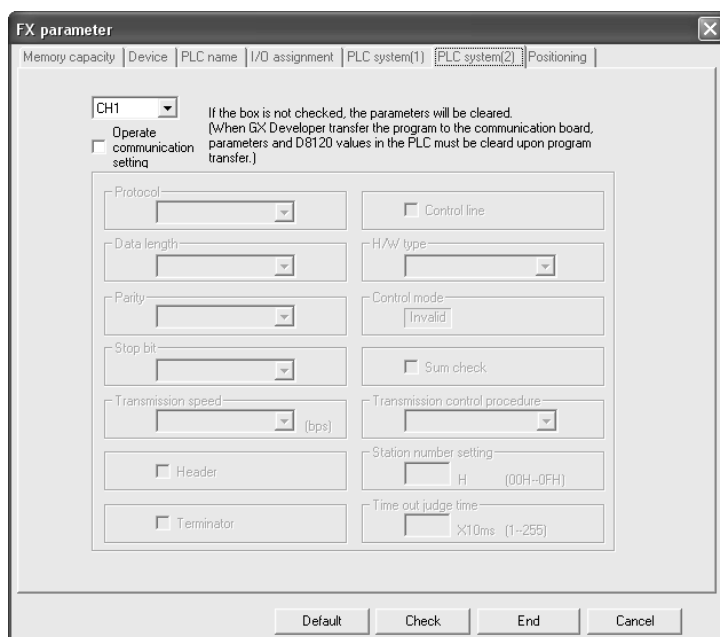

3 Setting the serial communication (parameters)

Select a channel to be used by putting a check mark in the check box for "Operate communication setting".

Execute the setting according to the connected communication equipment.

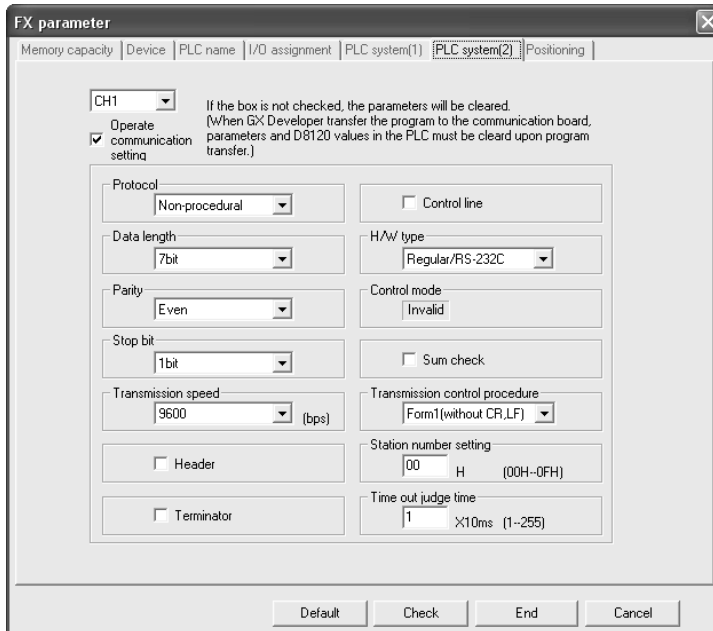

Caution

When setting "H/W type" to "RS485", put a check mark (✓) in the "Control line" check box.

4 Writing parameters to the PLC

Select [Online] - [Write to PLC] from the tool menu, put a check mark (✓) next to the "Parameter" and "Program" options, and then click [Execute].

A	Common Items
B	N:N Network
C	Parallel Link
D	Computer Link
E	Inverter Communication
F	Non-Protocol Communication (RS/RS2 Instruction)
G	Non-Protocol Communication (FX2N-232IF)
H	Programming Communication
I	Remote Maintenance

5.3 Communication Setting in Parameter Method (FXGP/WIN)

Two software packages, GX Developer and FXGP/WIN for Windows, are available in the parameter method. This section explains the parameter method using FXGP/WIN. Ch2 cannot be set using FXGP/WIN.

5.3.1 Operating procedure

This subsection explains the serial communication setting method. Suppose that FXGP/WIN is already started up.

1 Displaying the serial communication (parameter) setting

Select [Option] - [Serial setting (parameter)] from the tool menu. The following dialog box appears according to absence/presence of the parameter settings.

1. When there is no parameter setting

There is no communication setting. Click the [Yes] button.

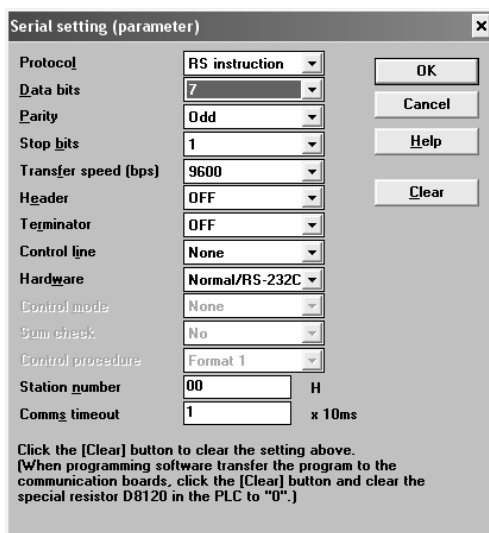
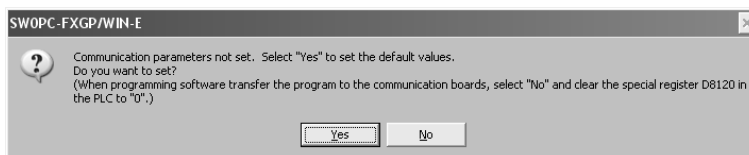

2. When there are already parameter settings.

The existing communication setting contents are displayed.

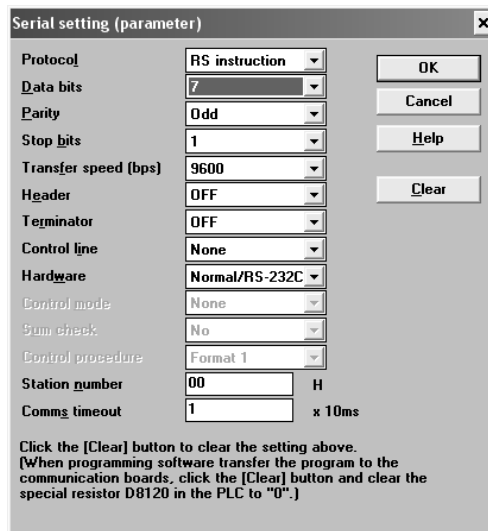

2 Executing serial communication (parameter) settings

Execute the settings according to the connected communication equipment.

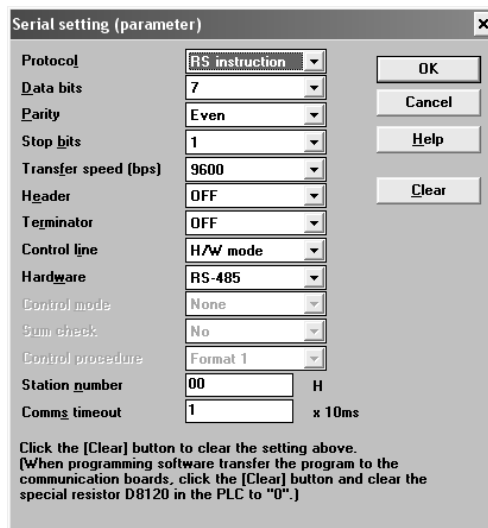

Caution

When setting "Hardware" to "RS-485", set "Control line" to "H/W mode".

3 Writing a sequence program (parameters) to the PLC

Select [PLC] - [Transfers] - [Write] from the tool menu, and click [OK].

A	Common Items
B	N:N Network
C	Parallel Link
D	Computer Link
E	Inverter Communication
F	Non-Protocol Communication (RS/RS2 Instruction)
G	Non-Protocol Communication (FX2N-232IF)
H	Programming Communication
I	Remote Maintenance

6. Creating Programs (RS Instruction)

This chapter explains how to create programs for non-protocol communication using RS instruction and how such programs operate.

6.1 Checking Contents of Related Devices

The tables below show devices used in non-protocol communication using RS instruction.

1. Bit devices

R: Read, W: Write

Device	Name	Description	Attribute
M8063	Serial communication error (ch1)	This device turns ON when a communication error occurs. When this device (serial communication error) turns ON, D8063 stores the corresponding error code.	R
M8120	Communication setting keep	This device keeps the communication setting status (for FX0N PLC).	W
M8121	Sending wait flag	This device remains ON while the PLC is waiting to send.	R
M8122	Sending request	When this device is set to ON, the PLC starts to send.	R/W
M8123	Receiving complete flag	This device turns ON when receiving is completed. While this device (receiving complete flag) is ON, the PLC cannot receive any data.	R/W
M8124	Carrier detection flag	This device turns ON in synchronization with the CD signal.	R
M8129*1	Timeout determination flag	This device turns ON when data receiving is suspended and the next set of data is not given within the time set by the timeout settings device (D8129).	R/W
M8161	8-bit processing mode	This device sets the send/receive data bit length to 16-bit or 8-bit. ON: 8-bit mode OFF: 16-bit mode	W

*1. Not provided in FX0N, FX2(FX), FX2C, and FX2N (before Ver. 2.00) PLCs.

2. Word devices

R: Read, W: Write

Device	Name	Description	Attribute
D8063	Error code display	When the serial communication error flag (M8063) turns ON, this device stores the corresponding error code.	R/W
D8120	Communication format setting	This device sets the communication format.	R/W
D8122	Amount of data remaining to be sent	This device stores the amount of remaining data to be sent.	R
D8123	Amount of data received	This device stores the amount of received data.	R
D8124	Header	This device sets the header (initial value: STX (H02)).	R/W
D8125	Terminator	This device sets the terminator (initial value: ETX (H03)).	R/W
D8129*1	Timeout time setting	This device sets the timeout time.	R/W
D8405*2	Communication parameter display	This device stores communication parameters set in the PLC.	R
D8419*2	Operation mode display	This device stores the communication type being used.	R

*1. Not provided in FX0N, FX2(FX), FX2C, and FX2N (before Ver. 2.00) PLCs.

*2. Provided only in FX3U and FX3UC PLCs.

6.2 How to Use RS Instruction

This section explains the function, operation and programming method of RS instruction.

1. Applicable devices

Oper- and Type	Bit Devices							Word Devices										Others						
	System/User							Digit Specification				System/User				Special Unit	Index		Con- stant	Real Number	Charac- ter String	Pointer		
	X	Y	M	T	C	S	D□.b	KnX	KnY	KnM	KnS	T	C	D	R	U□\G□	V	Z	Modify	K	H	E	"□"	P
(S•) m																								
(D•) n																								

▲: Applicable only in FX3U, FX3UC PLCs.

m, n: 0 to 4096 points in FX2N, FX3U, FX2NC, and FX3UC PLCs
 (However, "m + n" should not be more than 8000 points.)
 0 to 256 points in FX2(FX), FX2C, FX0N, FX1S, FX1N, and FX1NC PLCs

2. Program example

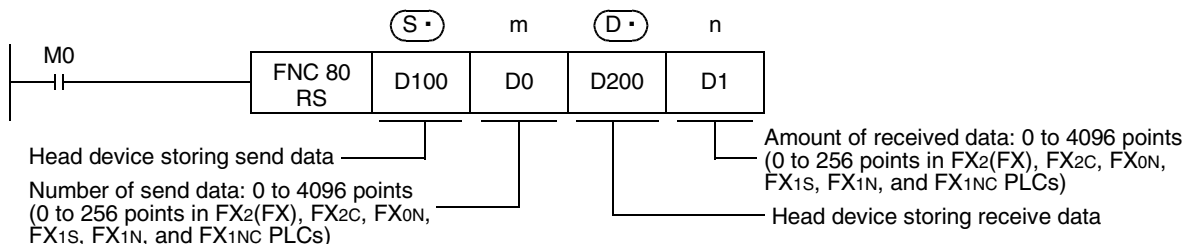

6.2.1 Applicable frames

Message frames used in communication can be selected by setting the communication format. The table below shows the message frames applicable in RS instruction.

Format	Header	Data	Terminator	Header: Provided / Terminator: Provided
1		Data		Header: Not provided Terminator: Not provided
2		Data	Terminator	Header: Not provided Terminator: Provided
3	Header	Data		Header: Provided Terminator: Not provided
4	Header	Data	Terminator	Header: Provided Terminator: Provided

1. Header

When "header provided" is selected in the communication format settings, the lowest-order byte of D8124 is used.

When data is sent, the lowest-order byte of D8124 is added at the head of the specified send data to be sent. When data is received, receiving begins when the data on lowest-order byte of D8124 is received.

2. Terminator

When "terminator provided" is selected in the communication format settings, the lowest-order byte of D8125 is used.

When data is sent, the lowest-order byte of D8125 is added at the end of the specified send data.

When data is received, receiving is completed*1 when the data on lowest-order byte of D8125 is received.

*1. Receiving is completed also when the amount of received data specified by the RS instruction is received or when the receiving of data is suspended and the next set of data is not executed within the timeout time set by D8129.

6.2.2 Function and operation

RS instruction specifies the head device storing the sent data sent from the PLC, amount of data, head device storing the received data and the maximum allowable amount of received data.
 Create a program as shown below.

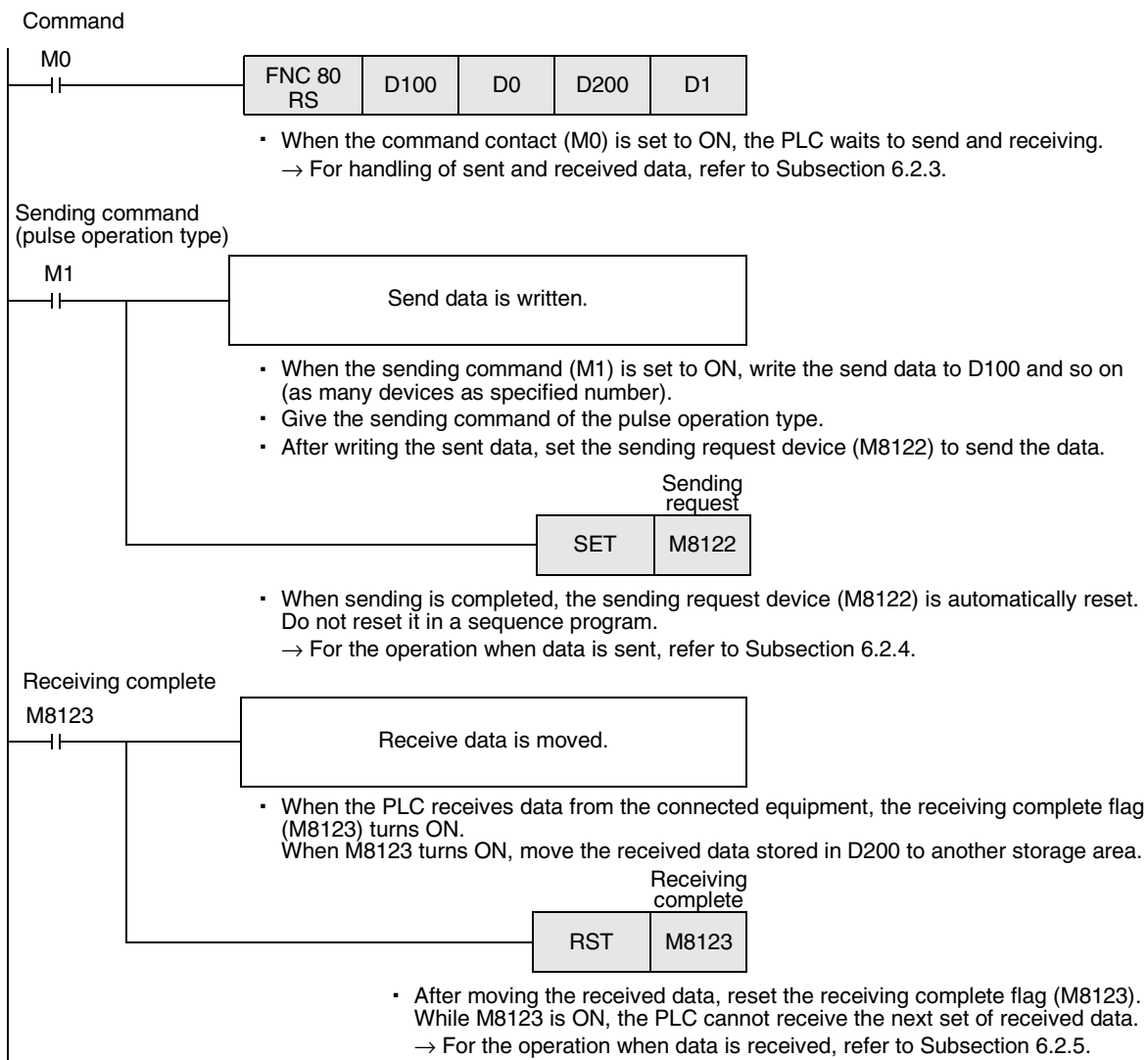

6.2.3 Send/receive data and amount of data

RS instruction can handle sent and received data in two modes, 16-bit mode and 8-bit mode. Data is handled as shown below in each mode. (In the examples shown below, "header provided" and "terminator provided" are selected in the communication setting.)

1. Handling of 16-bit data (when M8161 is set to OFF)

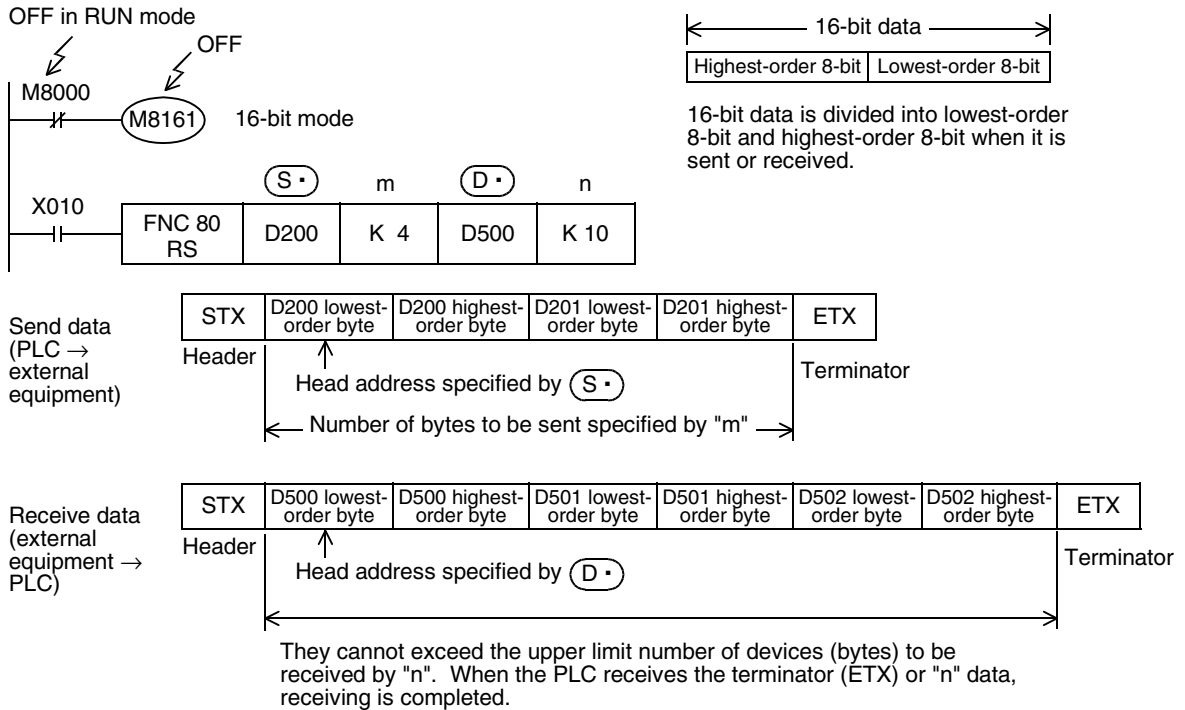

1) Send data and amount of remaining send data

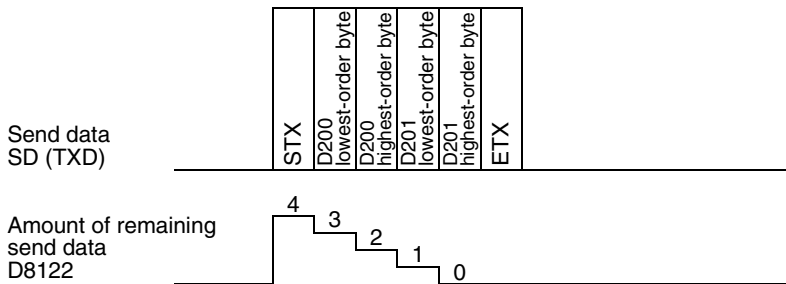

2) Receive data and amount of data already received

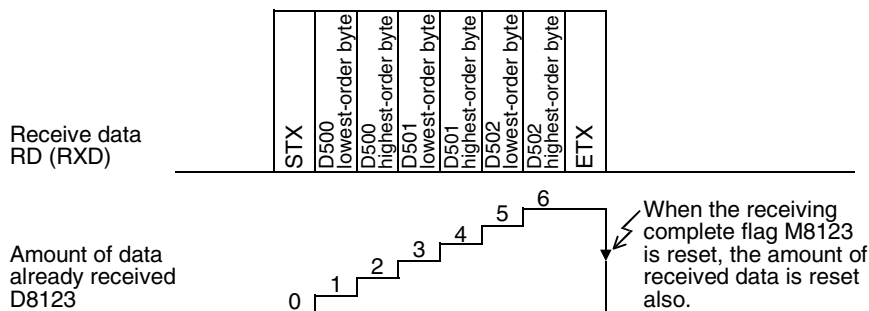

Caution on other instructions using M8161

M8161 is shared by RS, ASCII, HEX, CCD, and CRC (provided only in FX3U and FX3UC PLCs) instructions.

A Common Items
 B N:N Network
 C Parallel Link
 D Computer Link
 E Inverter Communication
 F Non-Protocol Communication (RS/RS2 Instruction)
 G Non-Protocol Communication (FX2N-232IF)
 H Programming Communication
 I Remote Maintenance

2. Handling of 8-bit data (when M8161 is set to ON)

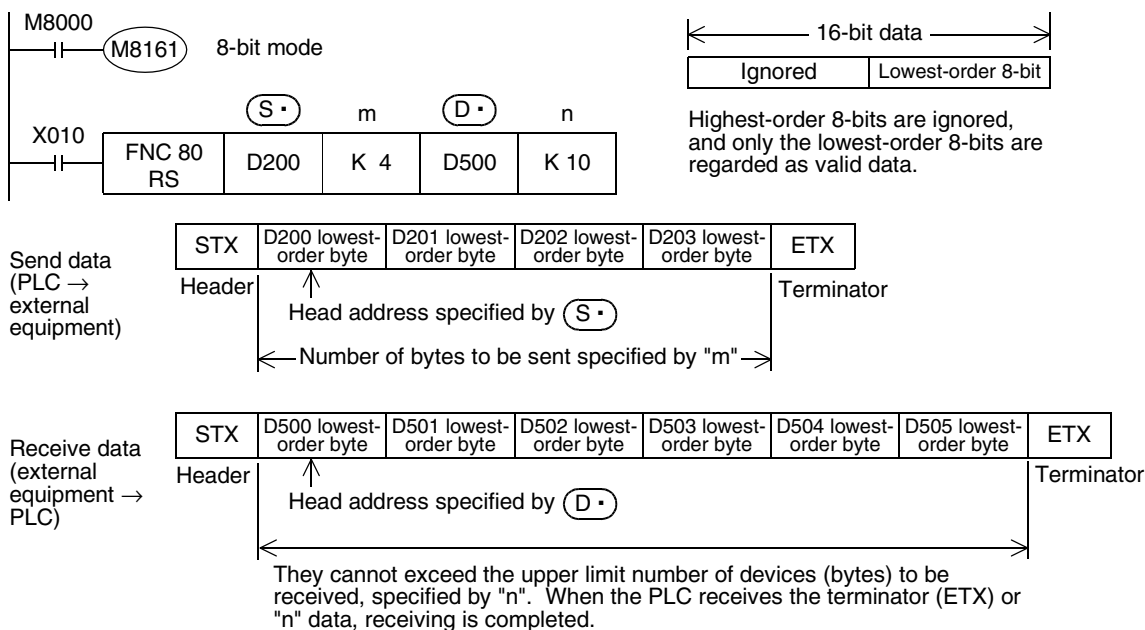

1) Send data and amount of remaining data

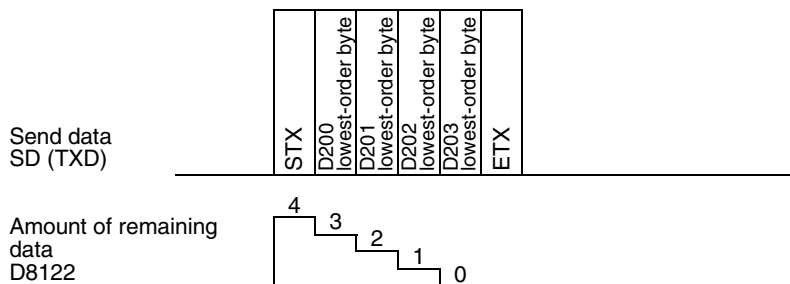

2) Receive data and amount of received data

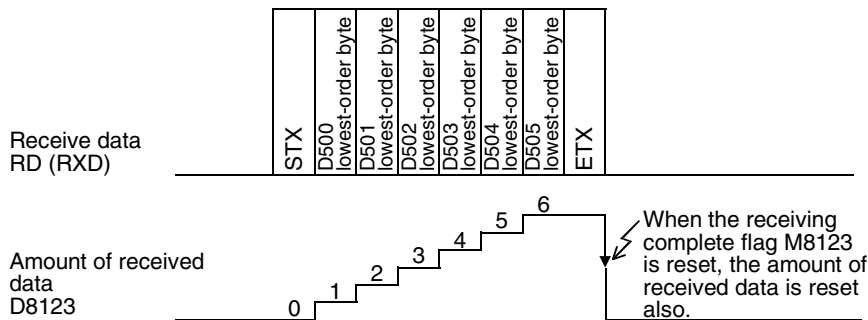

Caution on other instructions using M8161

M8161 is shared by RS, ASCII, HEX, CCD, and CRC (provided only in FX3U and FX3UC PLCs) instructions.

6.2.4 Operation when data is sent

When the sending request flag (M8122) is set to ON while RS instruction is driven, the PLC sends the data stored in the data registers (S•) to ((S•)+m-1) specified by the RS instruction.
When sending of the data is complete, the sending request flag (M8122) is automatically set to OFF.

1. Timing at which sending is started

When RS instruction is executed after the sending request flag (M8122) is set to ON, the PLC starts to send. When sending begins, the PLC sends the data stored in the data registers specified by the RS instruction in interrupt processing without regarding the operation cycle.

2. Timing at which sending is completed

When all send data is sent, sending is completed.
(If the terminator is set, the terminator is included in the send data.)

3. Cautions on sending

When sending data, observe the following cautions

- 1) While the sending request flag (M8122) is ON, do not change the amount of send data or contents of send data.
- 2) Do not set the sending request flag (M8122) to OFF in a sequence program.
If the send data is changed while the sending request flag (M8122) is ON or if the sending request flag (M8122) is set to OFF in a sequence program, correct data is not sent.

6.2.5 Operation when data is received

When RS instruction is executed, the PLC waits to receive. When the PLC receives data from the connected equipment and receiving is completed, the receiving complete flag (M8123) is set to ON.

When the PLC receives data, it stores the received data to the data registers (D•) to ((D•)+n-1) specified by the RS instruction.

While the receiving complete flag (M8123) is ON, the PLC cannot receive new data.

1. Timing at which receiving is started

When the PLC receives data while it is waiting to receive, it starts receiving data.

When receiving begins, the PLC stores the received data in interrupt processing without regarding the operation cycle.

When the header (D8124) is specified in the communication format, however, the PLC starts receiving when it receives the code set in the header. And the PLC stores the received data except the header.

2. Timing at which receiving is completed

Receiving is completed in the following three conditions. When either condition is established, receiving is completed.

- 1) When the PLC receives as much data as specified by the RS instruction
- 2) When "terminator provided" is selected in the communication format, and the PLC receives the code set in the terminator (D8125)
- 3) When data receiving is suspended and the PLC does not receive the next set of data within the time set in the timeout determination time setting device (D8129)
At this time, the timeout determination flag (M8129) turns ON.
(The timeout determination flag is not provided in FX0N, FX2(FX), FX2C, and FX2N (before Ver. 2.00) PLCs.)

A	Common Items
B	N:N Network
C	Parallel Link
D	Computer Link
E	Inverter Communication
F	Non-Protocol Communication (RS/RS2 Instruction)
G	Non-Protocol Communication (FX2N-232IF)
H	Programming Communication
I	Remote Maintenance

3. Operation of the timeout determination flag (which is not provided in FX0N, FX2(FX), FX2C, and FX2N (before Ver. 2.00) PLCs)

When data receiving is suspended, counting of the timeout time is started immediately. If the PLC does not receive the next set of data within the timeout determination time set by D8129, the timeout determination flag (M8129) is set to ON. At this time, the receiving complete flag (M8123) is set to ON also. The timeout determination time (D8129) can be set to a value from 1 to 255 (10 ms to 2550 ms).

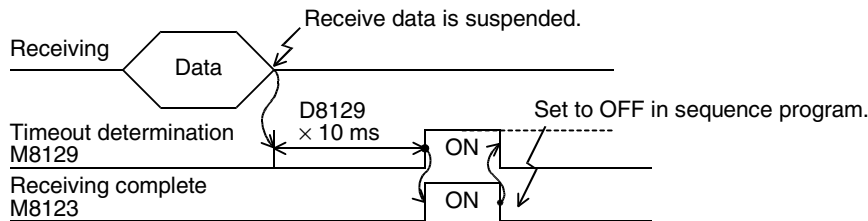

The timeout determination flag (M8129) does not turn OFF automatically. Set it to OFF in a sequence program. (When M8123 is set to OFF, M8129 is set to OFF also.) By using this function, the PLC can receive data without the terminator from such equipment that the number of send data varies.

4. When the control line is set to the interlink mode

When the interlink mode is selected in the communication format, the following sequence is adopted from the start of receiving to receiving completion:

- 1) When the amount of data already received becomes "number of bytes to be received -30", the control line ER (DTR) turns OFF. When the control line ER (DTR) turns OFF, the counterpart equipment should suspend data sending. After the control line ER (DTR) turns OFF, the PLC can receive up to 30 characters (bytes).
- 2) When the counterpart equipment suspends data sending, the PLC sets the timeout determination flag (M8129) and receiving complete flag (M8123) to ON after the timeout determination time (D8129). Move the received data in a sequence program, and then set to OFF the receiving complete flag (M8123) and timeout determination flag (M8129).
- 3) When the receiving complete flag (M8123) is set to OFF, the control line ER (DTR) turns ON. When the control line ER (DTR) turns ON, begin sending data again from the counterpart equipment.
- 4) Repeat the steps 1) to 3) until data receiving is completed.

5. Cautions on receiving

When receiving data, observe the following cautions:

- 1) While the receiving complete flag (M8123) is ON, the PLC cannot receive the next set of data. When the receiving complete flag is set to OFF, the PLC waits to receive.
- 2) When RS instruction is driven, the receiving complete flag (M8123) remains OFF in an FX1S, FX1N, or FX1NC PLC if the amount of received data (n) is "0", but the PLC does not start to wait to receive. To make the PLC wait to receive, it is necessary to set the amount of received data "n" to "1" or more and set the receiving complete flag to OFF from ON.

6.3 Operation of Control Line

6.3.1 FX2(FX), FX2C, FX1S, FX0N, FX1N, FX1NC, and FX2N (before Ver. 2.00) PLCs

FX2, FX2C, FX1S, FX0N, FX1N, FX1NC, and FX2N (before Ver. 2.00) PLCs execute half-duplex, bidirectional communication.

When the sending flag is set to ON during receiving, the sending wait flag M8121 turns ON. When the receiving complete flag turns ON from OFF, the PLC starts to send.

1. When the control line is not provided

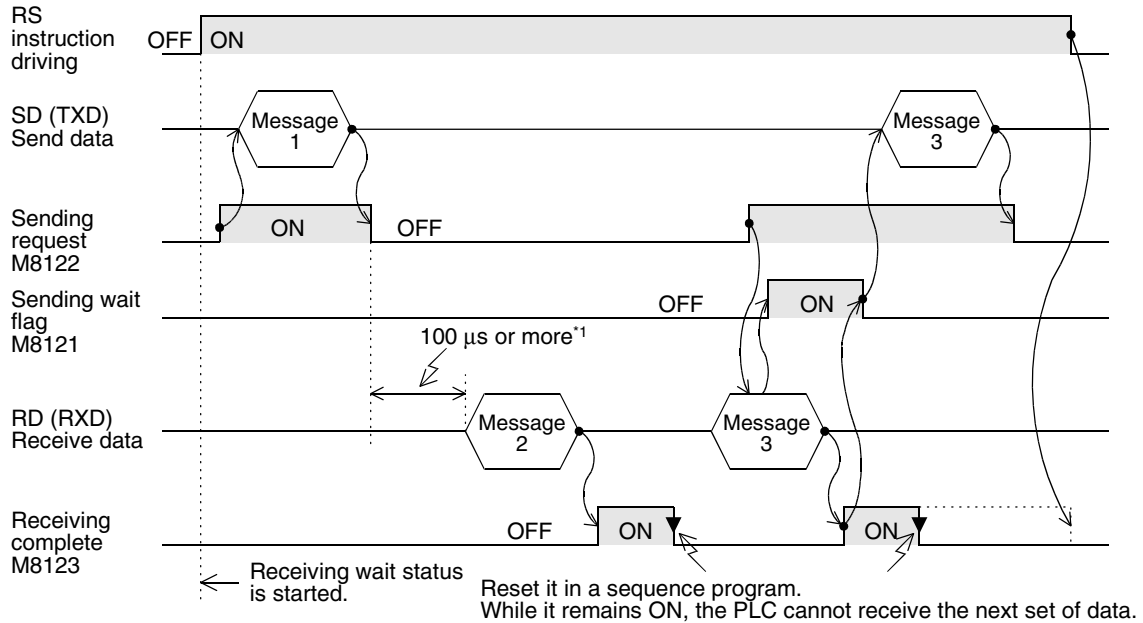

*1. Set it to 2 scan times or more in FX1S, FX0N, FX2(FX), FX2C, FX1N, and FX1NC PLCs.

2. When the control line is in the standard mode

Use this mode when only sending or receiving.

1) When only sending is executed

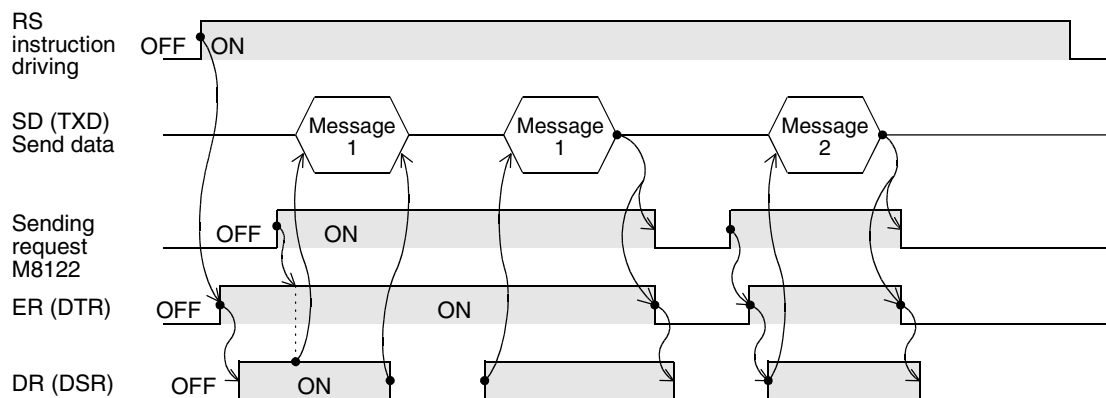

2) When only receiving is executed [The DR (DSR) signal is not used.]

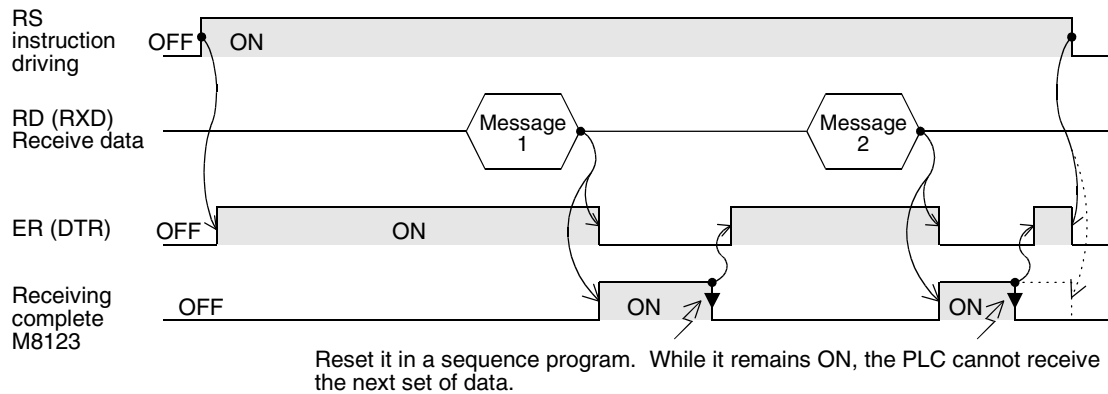

3. When the control line is in the modem mode

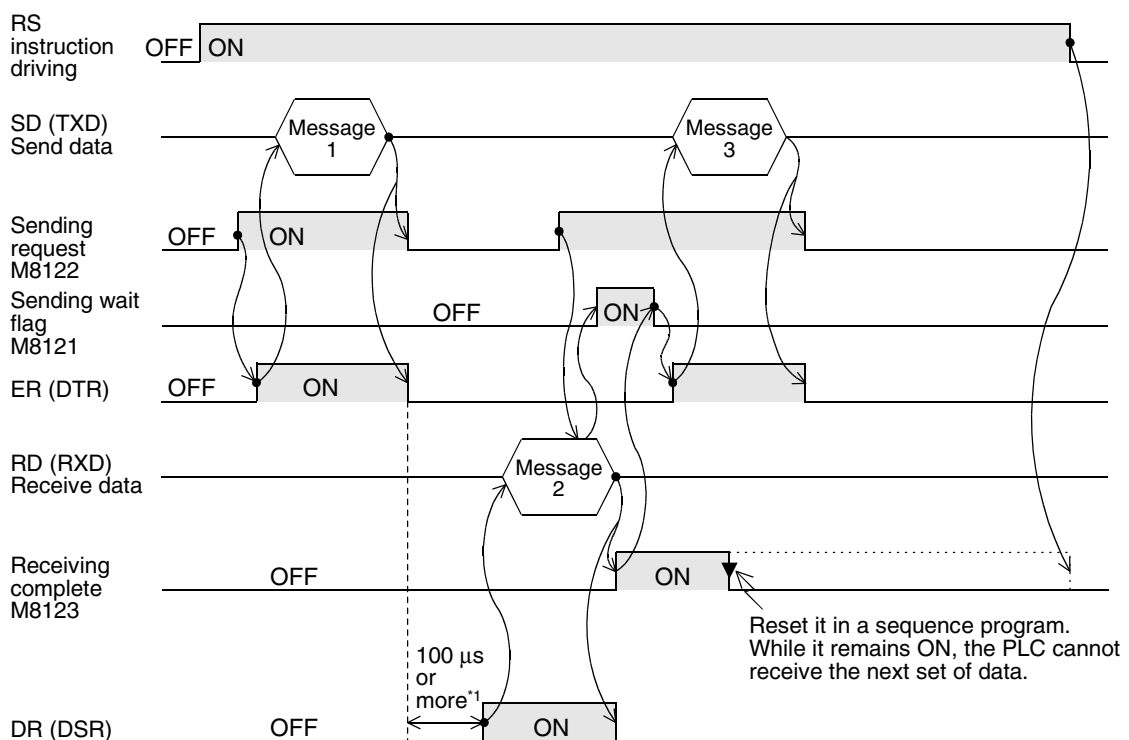

*1. Set it to 2 scan times or more in FX1S, FX0N, FX2(FX), FX2C, FX1N, and FX1NC PLCs.

6.3.2 FX2N (Ver. 2.00 or later), FX3U, FX2NC, and FX3UC PLCs

FX2N (Ver. 2.00 or later), FX3U, FX2NC, and FX3UC PLCs execute full-duplex, bidirectional communication. When executing half-duplex, bidirectional communication, pay attention not to set the sending flag to ON while receiving. If the sending flag is set to ON, the PLC starts to send. As a result, the counterpart equipment may not be able to receive data, and the sent and received data may be destroyed. In full-duplex, bidirectional communication, the sending wait flag M8121 does not turn ON. In FX3U and FX3UC PLCs, however, the sending wait flag M8121 remains ON while the DR (DSR) is OFF, the PLC waits to send, and the control line is in the standard mode or interlink mode.

1. Without control line

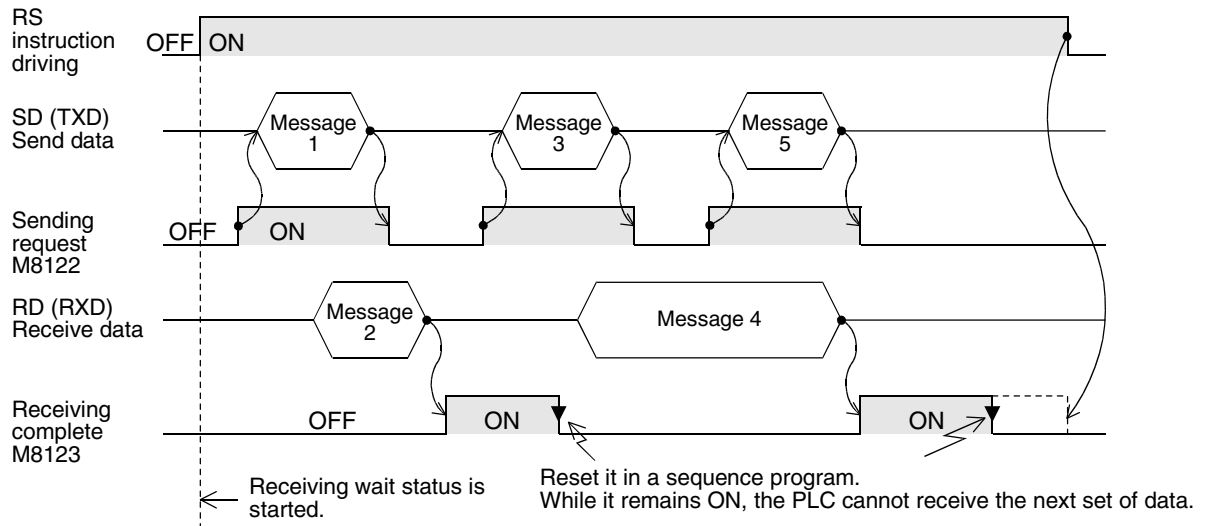

2. When the control line is in the standard mode

Use this mode when only sending or receiving.

The control line and transfer sequence are equivalent to those in FX2N PLCs (before Ver. 2.00). Refer to Subsection 6.3.1.

3. When the control line is in the modem mode

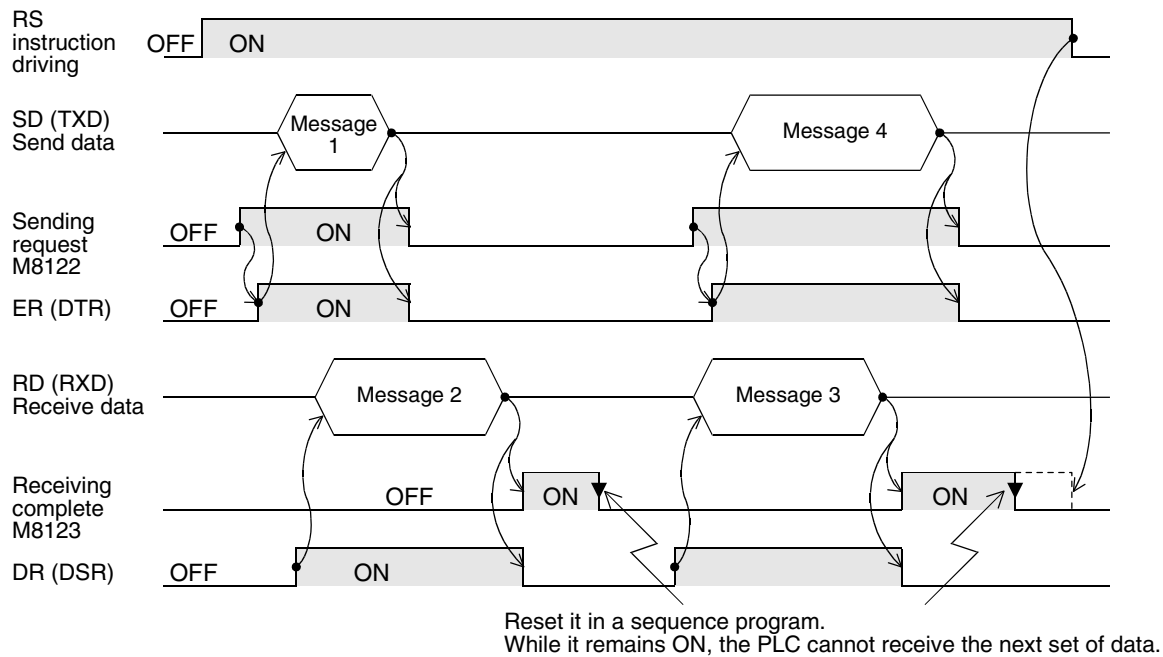

A	Common Items
B	N:N Network
C	Parallel Link
D	Computer Link
E	Inverter Communication
F	Non-Protocol Communication (RS/RS2 Instruction)
G	Non-Protocol Communication (FX2N-232IF)
H	Programming Communication
I	Remote Maintenance

4. When the control line is in the interlink mode

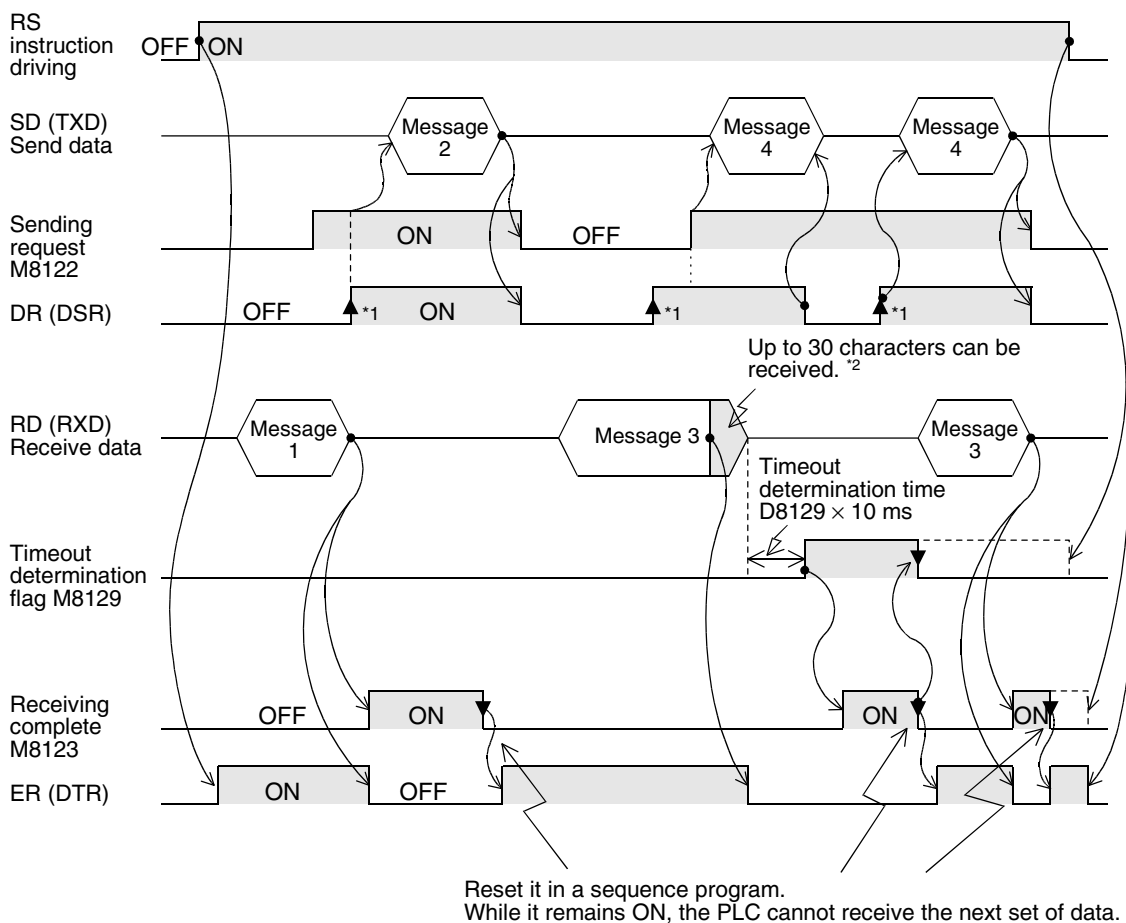

- *1. On the counterpart equipment side, set the DR (DSR) signal to ON when the PLC is ready to receive. The FX2N, FX3U, FX2NC or FX3UC PLC sends the send data when both the DR (DSR) signal and the sending request turn ON.
- *2. In the interlink mode, the PLC sets ER (DTR) signal to OFF 30 characters before reaching the specified amount of received data, and asks the counterpart equipment to stop sending. After that, the PLC can only receive up to 30 characters. In this case, temporarily stop sending, and then send the remaining data after ER (DTR) signal turns ON again. When sending is stopped, the PLC finishes receiving after the timeout determination time has come. When sending is not stopped, the PLC finishes receiving after it has received the final send data or 30 characters. Accordingly, make sure that the amount of received data is "30 + α".

6.4 Important Points in Creating Programs

- 1) RS instruction can be used as many times as necessary in a program, but make sure that only one RS instruction is driven at a time.
 For switching RS instruction to be driven, provide the OFF time longer than one scan time.
- 2) In FX2(FX), FX2C, FX0N, FX1S, FX1N and FX1NC PLCs, make sure to provide an interval of two scan times or more between completion of sending and the start of receiving or between completion of receiving and the start of sending.
 In FX2N PLCs (whose version is before Ver. 2.00), provide an interval of 100 μs or more.
 In FX2N (whose version is Ver. 2.00 or later), FX3U, FX2NC and FX3UC PLCs, this interval is not necessary.
- 3) While RS instruction is being driven, change of D8120 is not accepted.
 To change D8120, set RS instruction to OFF, set D8120 to "0", and then set a new value to D8120.
- 4) In the interlink mode, set the amount of received data n to "31" or more.
 If it is set to "30" or less, the control line ER (DTR) is set to OFF as soon as the PLC receives data. As a result, the received data may be partially skipped.
- 5) Do not use another instruction which uses the same communication port. If such an instruction is used, communication may not be executed normally.
 FX3U and FX3UC PLCs: RS2 instruction, IVDR instruction, etc.
 FX2N and FX2NC PLCs: EXTR instruction

6.5 Communication Error

When a communication error occurs, the error flag M8063 turns ON and D8063 stores the error code.

Error code	Description
6301	Parity error, overrun error or framing error

→ Confirm the contents in "Chapter 11. Troubleshooting".

A	Common Items
B	N:N Network
C	Parallel Link
D	Computer Link
E	Inverter Communication
F	Non-Protocol Communication (RS/RS2 Instruction)
G	Non-Protocol Communication (FX2N-232IF)
H	Programming Communication
I	Remote Maintenance

7. Practical Program Example (RS Instruction)

7.1 Example of Printing Using RS Instruction (in Connection in Accordance with RS-232C)

In this example, a printer having the RS-232C interface is connected to a PLC, and data sent from the PLC is printed.

1. System configuration

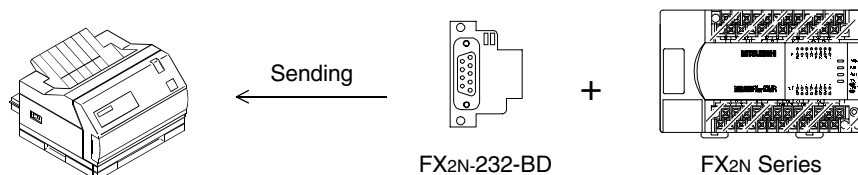

Use a communication cable suitable to the pin arrangement of the printer connector.
 (For representative wiring, refer to Chapter 4.)

2. Communication format

Align the communication format in the PLC with that in the used printer.
 (The table below shows the communication format in the main unit.)

Data length	8-bit
Parity	Even
Stop bit	2-bit
Baud rate	2400 bps
Header	Not provided
Terminator	Not provided
Control line (hardware)	Not provided
Communication method (protocol)	Non-protocol method

3. Sequence program

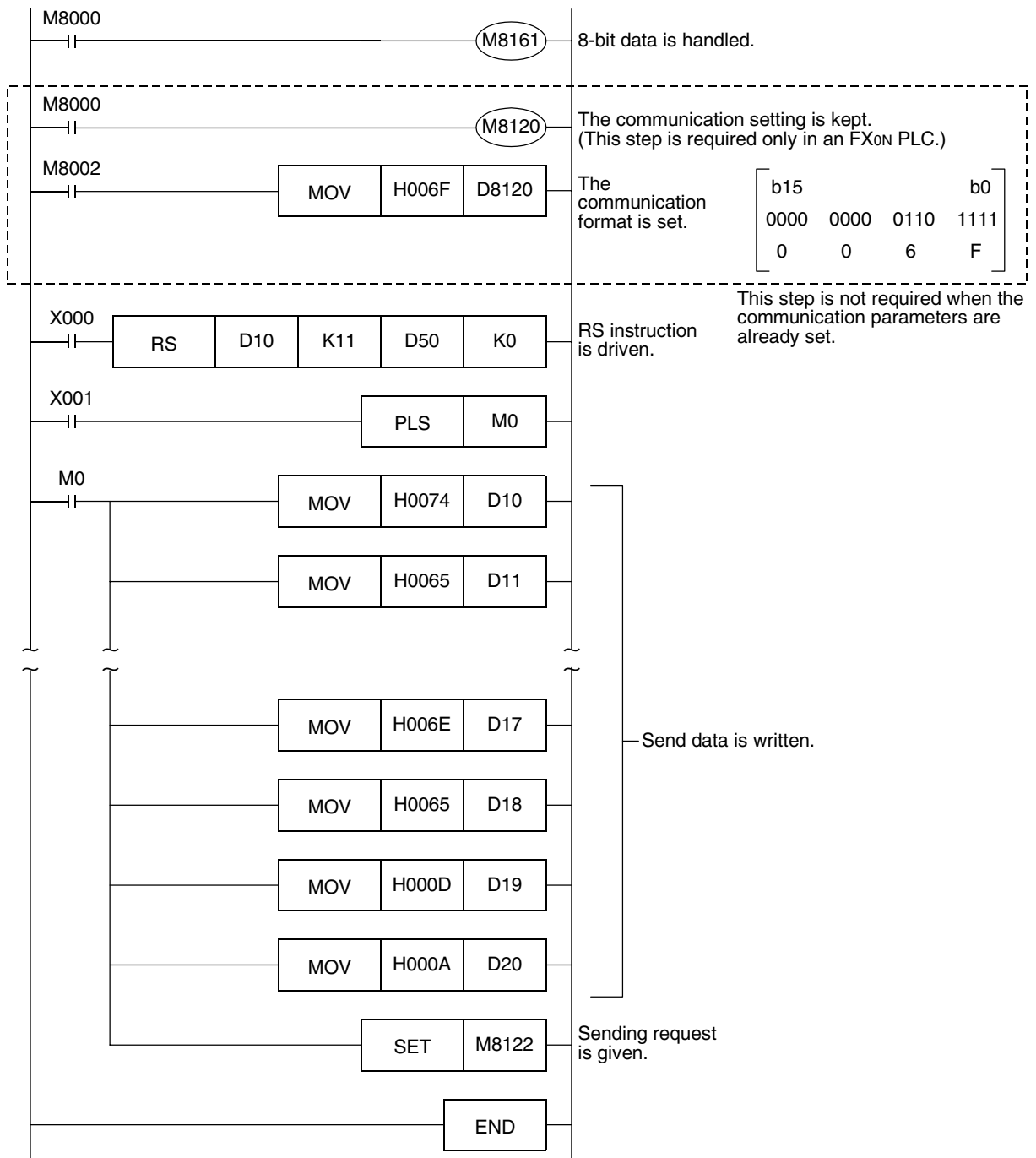

4. Operation

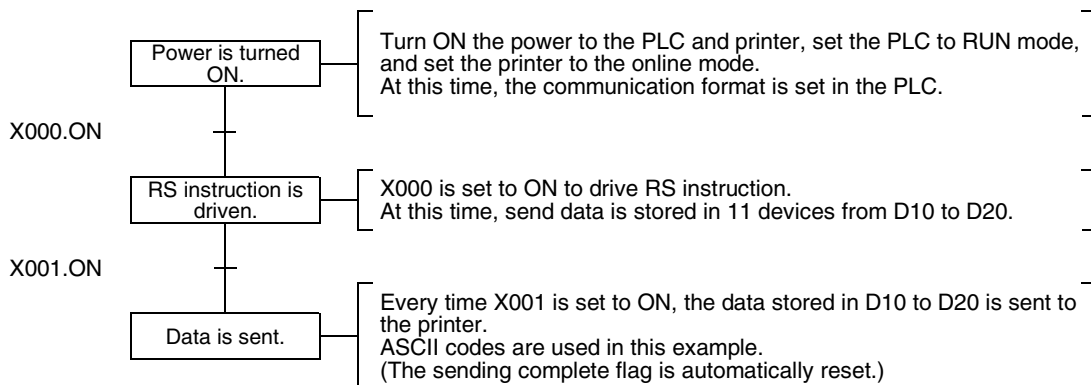

A	Common Items
B	N:N Network
C	Parallel Link
D	Computer Link
E	Inverter Communication
F	Non-Protocol Communication (RS/RS2 Instruction)
G	Non-Protocol Communication (FX2N-232IF)
H	Programming Communication
I	Remote Maintenance

8. Creating Programs (RS2 Instruction)

This chapter explains how to create programs for non-protocol communication using RS2 instruction and how such programs operate.

RS2 instruction is supported only in FX3U and FX3UC PLCs.

RS2 instruction has the following additional functions which are not provided in RS instruction:

- 1) Up to 4 characters (bytes) can be specified as the header and terminator.
- 2) The sum check can be added automatically.
- 3) The communication port (channel) can be specified.

8.1 Checking Contents of Related Devices

The tables below show devices used in non-protocol communication using RS2 instruction.

1. Bit devices

R: Read, W: Write

Device		Name	Description	Attribute	
ch1	ch2				
M8063	M8438	Serial communication error	This device turns ON when a communication error occurs. When this device (serial communication error) turns ON, D8063 or D8438 stores the corresponding error code.	R	
M8401	M8421	Sending wait flag	This device remains ON while the PLC is waiting to send.	R	
M8402	M8422	Sending request	When this device is set to ON, the PLC starts to send.	R/W	
M8403	M8423	Receiving complete flag	This device turns ON when receiving is completed. While this device (receiving complete flag) is ON, the PLC cannot receive any receive data.	R/W	
M8404	M8424	Carrier detection flag	This device turns ON in synchronization with the CD (DCD) signal.	R	
*1	M8405	M8425	Data set ready (DSR) flag	This device turns ON in synchronization with the DR (DSR) signal.	R
M8409	M8429	Timeout determination flag	This device turns ON when data receiving is suspended and the next set of receive data is not given within the time set by the timeout time setting device.	R/W	

*1. Available in Ver.2.30 or later of FX3U or FX3UC PLC

2. Word devices

R: Read, W: Write

Device		Name	Description	Attribute																				
ch1	ch2																							
D8063	D8438	Serial communication error code	When the serial communication error flag turns ON, this device stores the corresponding error code.	R/W																				
D8400	D8420	Communication format setting	This device sets the communication format.	R/W																				
D8402	D8422	Amount of remaining send data	This device stores the amount of remaining send data.	R																				
D8403	D8423	Amount of data already received	This device stores the amount of data already received.	R																				
D8405	D8425	Communication parameter display	This devices stores communication parameters set in the PLC.	R																				
D8409	D8429	Timeout time setting	This device sets the timeout time.	R/W																				
D8410	D8430	Header 1 and header 2	These devices set the headers 1 to 4. <div style="text-align: center;"> <table border="1" style="margin: auto;"> <tr> <th colspan="5">Header</th> </tr> <tr> <td style="width: 20px;">1</td> <td style="width: 20px;">2</td> <td style="width: 20px;">3</td> <td style="width: 20px;">4</td> <td style="width: 100px;">Data</td> </tr> </table> </div>	Header					1	2	3	4	Data	R/W										
Header																								
1	2	3	4	Data																				
D8411	D8431	Header 3 and header 4	<table border="1" style="width: 100%; border-collapse: collapse;"> <thead> <tr> <th style="width: 10%;">Header</th> <th style="width: 35%;">ch1</th> <th style="width: 35%;">ch2</th> <th style="width: 20%;">Initial value</th> </tr> </thead> <tbody> <tr> <td>1</td> <td>D8410 (lowest-order byte)</td> <td>D8430 (lowest-order byte)</td> <td>H02 (STX)</td> </tr> <tr> <td>2</td> <td>D8410 (highest-order byte)</td> <td>D8430 (highest-order byte)</td> <td>H00</td> </tr> <tr> <td>3</td> <td>D8411 (lowest-order byte)</td> <td>D8431 (lowest-order byte)</td> <td>H00</td> </tr> <tr> <td>4</td> <td>D8411 (highest-order byte)</td> <td>D8431 (highest-order byte)</td> <td>H00</td> </tr> </tbody> </table> When "H00" is set to the header 1, headers are not provided. The area before H00 (in units of bytes) is used to set the headers.	Header	ch1	ch2	Initial value	1	D8410 (lowest-order byte)	D8430 (lowest-order byte)	H02 (STX)	2	D8410 (highest-order byte)	D8430 (highest-order byte)	H00	3	D8411 (lowest-order byte)	D8431 (lowest-order byte)	H00	4	D8411 (highest-order byte)	D8431 (highest-order byte)	H00	R/W
Header	ch1	ch2	Initial value																					
1	D8410 (lowest-order byte)	D8430 (lowest-order byte)	H02 (STX)																					
2	D8410 (highest-order byte)	D8430 (highest-order byte)	H00																					
3	D8411 (lowest-order byte)	D8431 (lowest-order byte)	H00																					
4	D8411 (highest-order byte)	D8431 (highest-order byte)	H00																					
D8412	D8432	Terminator 1 and terminator 2	These devices set the terminators 1 to 4. <div style="text-align: center;"> <table border="1" style="margin: auto;"> <tr> <th colspan="5">Terminator</th> </tr> <tr> <td style="width: 100px;">Data</td> <td style="width: 20px;">1</td> <td style="width: 20px;">2</td> <td style="width: 20px;">3</td> <td style="width: 20px;">4</td> </tr> </table> </div>	Terminator					Data	1	2	3	4	R/W										
Terminator																								
Data	1	2	3	4																				
D8413	D8433	Terminator 3 and terminator 4	<table border="1" style="width: 100%; border-collapse: collapse;"> <thead> <tr> <th style="width: 10%;">Terminator</th> <th style="width: 35%;">ch1</th> <th style="width: 35%;">ch2</th> <th style="width: 20%;">Initial value</th> </tr> </thead> <tbody> <tr> <td>1</td> <td>D8412 (lowest-order byte)</td> <td>D8432 (lowest-order byte)</td> <td>H03 (ETX)</td> </tr> <tr> <td>2</td> <td>D8412 (highest-order byte)</td> <td>D8432 (highest-order byte)</td> <td>H00</td> </tr> <tr> <td>3</td> <td>D8413 (lowest-order byte)</td> <td>D8433 (lowest-order byte)</td> <td>H00</td> </tr> <tr> <td>4</td> <td>D8413 (highest-order byte)</td> <td>D8433 (highest-order byte)</td> <td>H00</td> </tr> </tbody> </table> When "H00" is set to the terminator 1, terminators are not provided. The area before H00 (in units of bytes) is used to set the terminators.	Terminator	ch1	ch2	Initial value	1	D8412 (lowest-order byte)	D8432 (lowest-order byte)	H03 (ETX)	2	D8412 (highest-order byte)	D8432 (highest-order byte)	H00	3	D8413 (lowest-order byte)	D8433 (lowest-order byte)	H00	4	D8413 (highest-order byte)	D8433 (highest-order byte)	H00	R/W
Terminator	ch1	ch2	Initial value																					
1	D8412 (lowest-order byte)	D8432 (lowest-order byte)	H03 (ETX)																					
2	D8412 (highest-order byte)	D8432 (highest-order byte)	H00																					
3	D8413 (lowest-order byte)	D8433 (lowest-order byte)	H00																					
4	D8413 (highest-order byte)	D8433 (highest-order byte)	H00																					
D8414	D8434	Receiving sum (receive data)	This device stores the received sum check value.	R																				
D8415	D8435	Receiving sum (calculation result)	This device stores the sum check value calculated from the received data.	R																				
D8416	D8436	Sending sum	This device stores the sum check value added to the send data.	R																				
D8419	D8439	Operation mode display	This device stores the current communication being executed.	R																				

A	Common Items
B	N:N Network
C	Parallel Link
D	Computer Link
E	Inverter Communication
F	Non-Protocol Communication (RS/RS2 Instruction)
G	Non-Protocol Communication (FX2N-232IF)
H	Programming Communication
I	Remote Maintenance

8.2 How to Use RS2 Instruction

This section explains the function, operation and programming method of RS2 instruction.

1. Applicable devices

Oper- and Type	Bit Devices							Word Devices										Others						
	System/User							Digit Specification				System/User				Special Unit	Index		Con- stant	Real Number	Charac- ter String	Pointer		
	X	Y	M	T	C	S	D□.b	KnX	KnY	KnM	KnS	T	C	D	R	U□\G□	V	Z	Modify	K	H	E	"□"	P
(S•)														✓	✓				✓					
m														✓	✓					✓	✓			
(D•)														✓	✓				✓					
n														✓	✓					✓	✓			
n1																				✓	✓			

m, n: 0 to 4096 points
 (However, "m + n" should not be more than 8000 points.)
 n1: K1 or K2

2. Program example

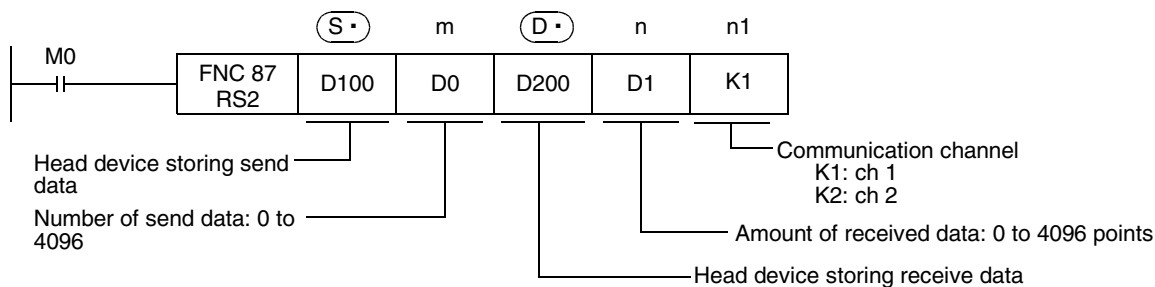

8.2.1 Applicable frames

Message frames used in communication can be selected by setting the communication format. The table below shows message frames applicable in RS2 instruction.

1	Data
2	Data CR+LF
3	Data Terminator
4	Data Terminator CR+LF
5	Data Terminator Sum check
6	Data Terminator Sum check CR+LF
7	Header Data
8	Header Data CR+LF
9	Header Data Terminator
10	Header Data Terminator CR+LF
11	Header Data Terminator Sum check
12	Header Data Terminator Sum check CR+LF

1. Header

When "header provided" is selected in the communication format settings, the values of D8410 and D8411 are used for ch.1, and the values of D8430 and D8431 are used for ch.2. Up to four headers can be set.

Header	Header 1	Header 2	Header 3	Header 4
ch1	D8410 (lowest-order byte)	D8410 (highest-order byte)	D8411 (lowest-order byte)	D8411 (highest-order byte)
ch2	D8430 (lowest-order byte)	D8430 (highest-order byte)	D8431 (lowest-order byte)	D8431 (highest-order byte)

When data is sent, the data set in the above devices is added at the head of the specified send data. When data is received, receiving begins when the data set in the above devices is received continuously.

Even if "header provided" is selected, headers are not provided if the header 1 is set to "00H". The area before 00H (in units of bytes) is used to set the headers.

2. Terminator

When "terminator provided" is selected in the communication format setting, the values of D8412 and D8413 are used for ch.1, and the values of D8432 and D8433 are used for ch.2. Up to four terminators can be set.

Terminator	Terminator 1	Terminator 2	Terminator 3	Terminator 4
ch1	D8412 (lowest-order byte)	D8412 (highest-order byte)	D8413 (lowest-order byte)	D8413 (highest-order byte)
ch2	D8432 (lowest-order byte)	D8432 (highest-order byte)	D8433 (lowest-order byte)	D8433 (highest-order byte)

When data is sent, the data set in the above devices is added at the end of the specified send data. When data is received, receiving is completed*1 when the data set in the above devices is received.

Even if "terminator provided" is selected, terminators are not provided if the terminator 1 is set to "00H". The area before 00H (in units of bytes) is used to set the terminators.

*1. Receiving is completed also when receiving of the amount of received data specified by the RS2 instruction is finished or when receiving of data is suspended and receiving of the next set of data is not executed within the timeout time set by D8409 or D8429.

A	Common Items
B	N:N Network
C	Parallel Link
D	Computer Link
E	Inverter Communication
F	Non-Protocol Communication (RS/RS2 Instruction)
G	Non-Protocol Communication (FX2N-232IF)
H	Programming Communication
I	Remote Maintenance

3. Sum check

When "sum check provided" is selected in the communication format setting, the sum check is executed for the sent and received data.

When selecting "sum check provided", make sure to select "terminator provided".

When data is sent, the sum of "data" + "terminator" is calculated, and added to the send data.

When data is received, it is checked whether the received sum is equivalent to the sum calculated by the PLC.

→ For details on the sum check, refer to Subsection 8.2.6.

4. CR + LF

When "CR + LF provided" is selected in the communication format setting, the character code of "CR + LF" is added at the end of the send data.

When data is received, receiving is completed when "CR + LF" is received continuously.

However, receiving is completed when receiving of the specified amount of received data is finished or when receiving of data was suspended and receiving of next data was not executed within the timeout determination time.

Make sure that "CR" is not included in the message.

8.2.2 Function and operation

RS2 instruction specifies the head device storing the send data sent from the PLC, amount of data, head device storing the received data and maximum allowable amount of received data.

Create a program as shown below.

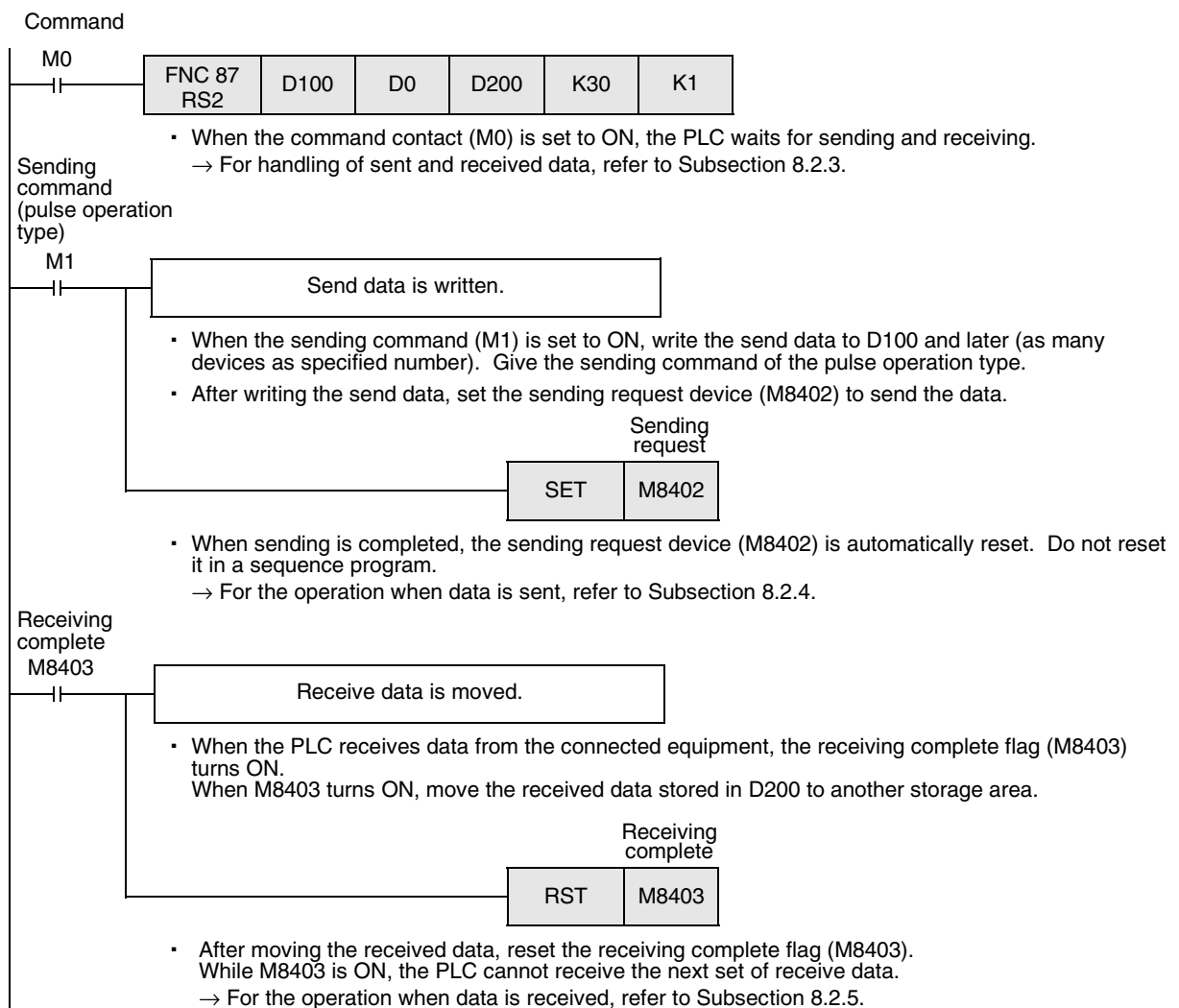

8.2.3 Send/receive data and amount of data

RS2 instruction can handle send data and receive data while storing two characters in one data register.

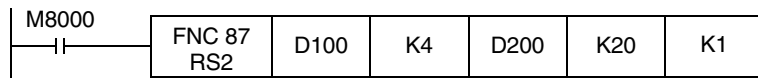

- Communication format setting
- Control line not provided
 - Headers provided [DLE + STX (D8410: 0210H D8411: 0000H)]
 - Terminators provided [DLE + ETX (D8412: 0310H D8413: 0000H)]
 - Sum check provided
 - CR + LF added

1. Send data and amount of remaining send data

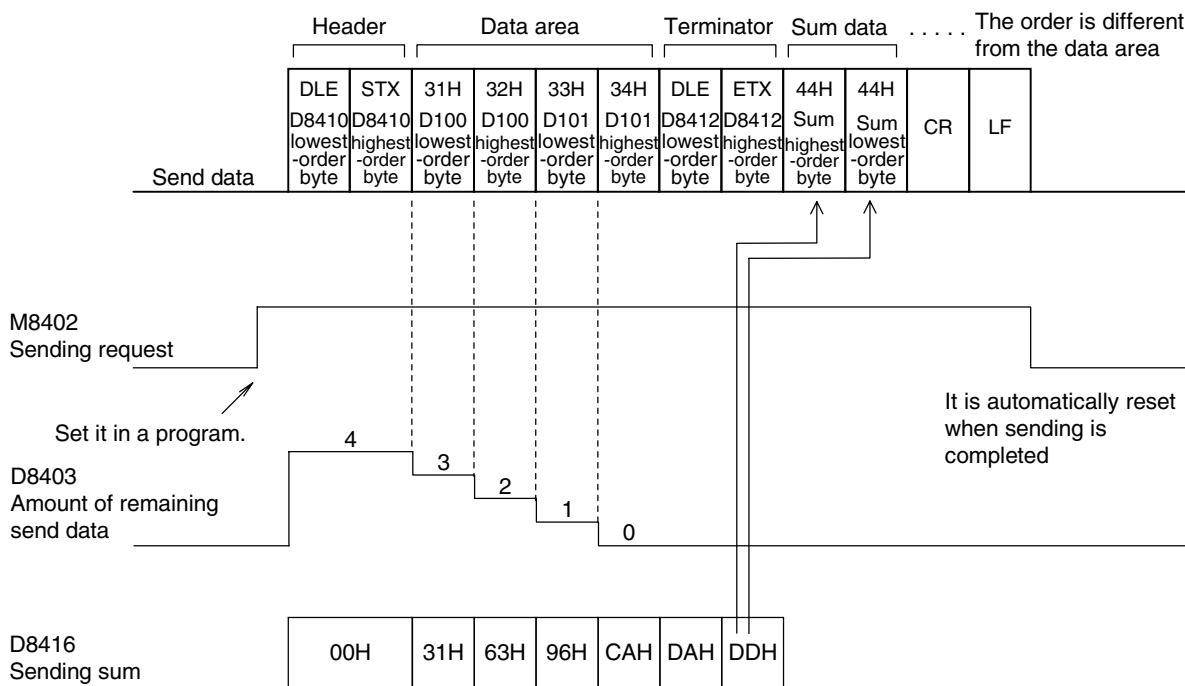

2. Receive data and amount of data already received

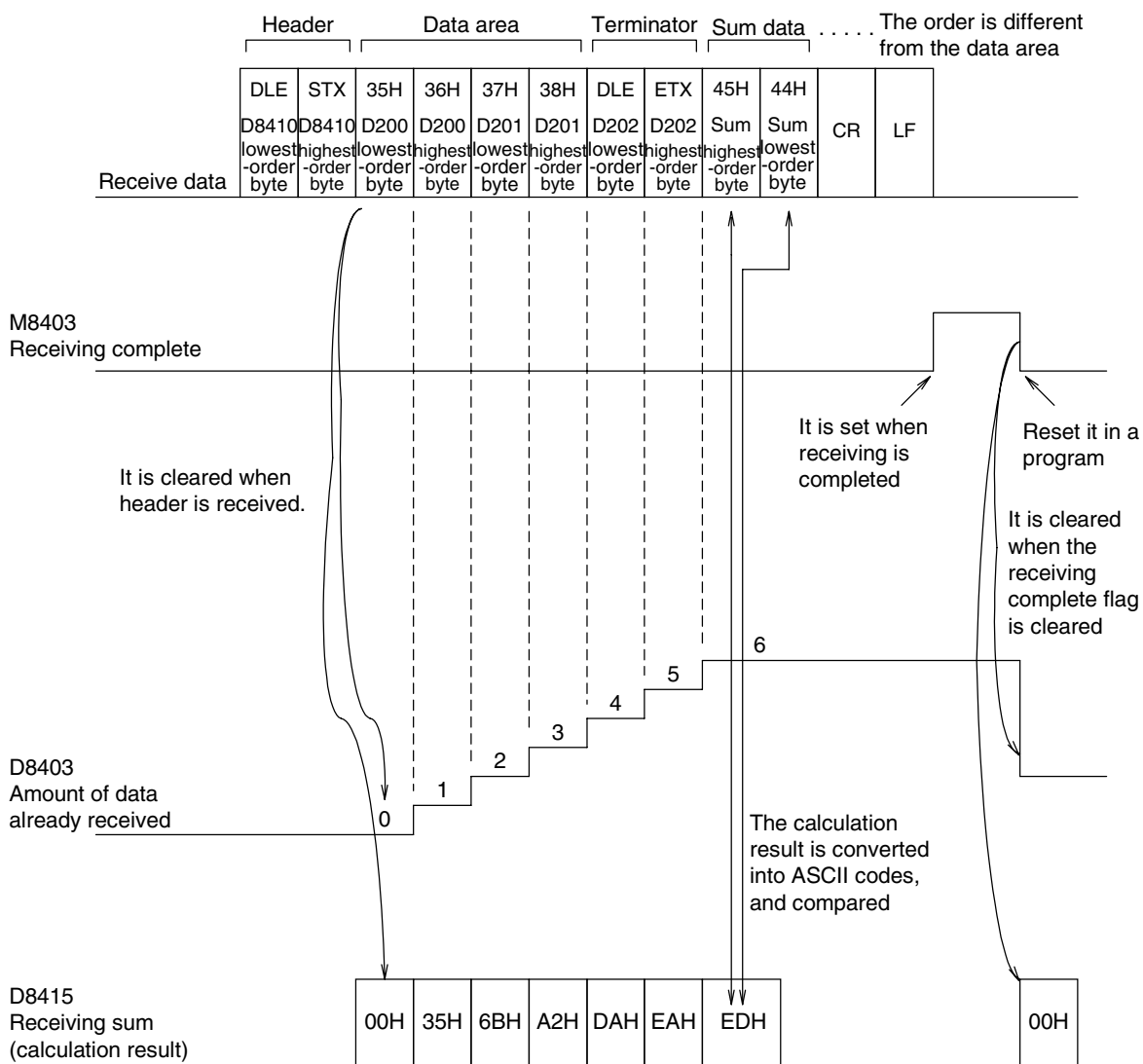

Caution

The 8-bit mode is not applicable in RS2 instruction.

8.2.4 Operation when data is sent

When the sending request flag is set to ON while RS2 instruction is driven, the PLC sends the data stored in the specified data registers (S \cdot) to (S \cdot +m-1).
 When using the communication port (ch1), set M8402.
 When using the communication port (ch2), set M8422.
 When sending of the data is completed, the sending request flag is automatically set to OFF.

1. Timing at which sending is started

When RS2 instruction is executed after the sending request flag is set to ON, the PLC starts to send.
 When sending is started, the PLC sends the data stored in the data registers specified by RS2 instruction in interrupt processing with no regard for the operation cycle.

2. Timing at which sending is completed

When all send data*1 are sent, sending is completed.

- *1. The "terminators", "sum check" and "CR + LF" set in the communication format are included also in the send data.

3. Cautions on sending

When sending data, observe the following cautions

- 1) While the sending request flag is ON, do not change the number of send data or the contents of send data.
- 2) Do not set the sending request flag to OFF in a sequence program.
 If the send data is changed while the sending request flag is ON or if the sending request flag is set to OFF in a sequence program, correct data is not sent.

8.2.5 Operation when data is received

When RS2 instruction is executed, the PLC waits to receive. When the PLC receives data from the connected equipment and receiving is completed, the receiving complete flag is set to ON.
 When the communication port (ch1) is used, M8403 turns ON.
 When the communication port (ch2) is used, M8423 turns ON.
 When the PLC receives data, it stores the received data to the data registers (D \cdot) to (D \cdot +n-1) specified by the RS2 instruction.
 While the receiving complete flag is ON, the PLC cannot receive new data.

1. Timing at which receiving is started

When the PLC receives data while it is waiting to receive, it starts receiving data.
 When receiving begins, the PLC stores the received data in interrupt processing without regarding the operation cycle.
 When the headers are specified in the communication format, however, the PLC starts receiving when it continuously receives the codes set in the headers. And the PLC stores the received data except the headers.

2. Timing at which receiving is completed

Receiving is completed in the following three conditions. When either condition is established, receiving is completed.

- 1) When the PLC receives as many receive data as specified by RS2 instruction
- 2) When the "terminators", "sum check" and "CR + LF" set in the communication format are received normally.

..... Data	CR+LF		
..... Data	Terminator		
..... Data	Terminator	CR+LF	
..... Data	Terminator	Sum check	
..... Data	Terminator	Sum check	CR+LF

- 3) When data receiving is suspended and the PLC does not receive the next set of data within the time set in the timeout determination time setting device (D8409 or D8429) the timeout determination flag (M8409 or M8429) turns ON.

A	Common Items
B	N:N Network
C	Parallel Link
D	Computer Link
E	Inverter Communication
F	Non-Protocol Communication (RS/RS2 Instruction)
G	Non-Protocol Communication (FX2N-232IF)
H	Programming Communication
I	Remote Maintenance

3. Operation of timeout determination flag

When data receiving is suspended, if the PLC does not receive the next set of data within the preset timeout determination time, the timeout determination flag is set to ON.

At this time, the receiving complete flag is also set to ON.

The timeout determination time can be set to a value from 1 to 255 (10 ms to 2550 ms).

Name	ch1	ch2
Timeout determination flag	M8409	M8429
Timeout determination time	D8409	D8429

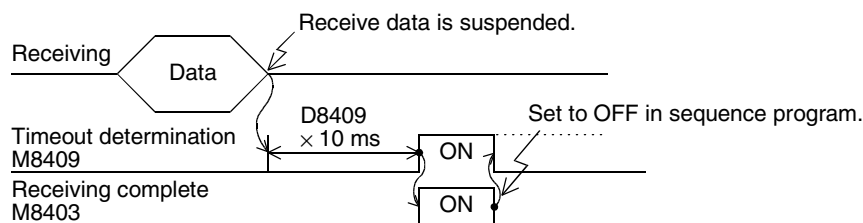

The timeout determination flag does not turn OFF automatically. Set it to OFF in a sequence program. (When the receiving complete flag is set to OFF, the timeout determination flag is also set to OFF.)

By using this function, the PLC can receive data without the terminator from such equipment that the number of send data varies.

4. When the control line is set to the interlink mode

When the interlink mode is selected in the communication format, the following sequence is adopted from start of receiving to completion of receiving:

- 1) When the amount of data already received becomes "preset amount of received data -30", the control line ER (DTR) turns OFF.
 When the control line ER (DTR) turns OFF, the counterpart equipment should suspend data sending.
 After the control line ER (DTR) turns OFF, the PLC can receive up to 30 characters (bytes).
- 2) When the counterpart equipment suspends data sending, the PLC sets to ON the timeout determination flag and receiving complete flag after the preset timeout determination time.
 Move the received data in a sequence program, and then set the receiving complete flag and timeout determination flag to OFF.
- 3) When the receiving complete flag is set to OFF, the control line ER (DTR) turns ON.
 When the control line ER (DTR) turns ON, restart data sending from the counterpart equipment.
- 4) Repeat the steps 1) to 3) until data receiving is completed.

5. Cautions on receiving

When receiving data, observe the following cautions

- 1) While the receiving complete flag is ON, the PLC cannot receive the next set of receive data.
 When the receiving complete flag is set to OFF, the PLC waits to receive.
- 2) Set the amount of received data to a value including "terminators", "sum check" and "CR+LF".
 If the specified amount of received data is small, the serial communication error flag (M8063 or M8438) turns ON.

8.2.6 Sum check code

The sum check code indicates a two-digit ASCII code converted from the lowest-order byte (8-bit) of the result (sum) acquired by adding the sum check target data as hexadecimal data.

By setting a parameter, set whether or not the sum check code is added in the message.

- When "sum check provided" is selected, the sum check code is added in the message during sending. During receiving, the sum check code is compared with the value calculated from the received data to check the received data.
- When "sum check not provided" is selected, the sum check code is not added, so the received data is not checked either.

A calculation example of the sum check code is shown below.

Example: When the communication format (parameters) is set as follows

- Control line not provided
- Headers provided [DLE+STX (D8410: 0210H, D8411: 0000H)]
- Terminators provided [DLE+ETX (D8412: 0310H, D8413: 0000H)]

In the case of send data

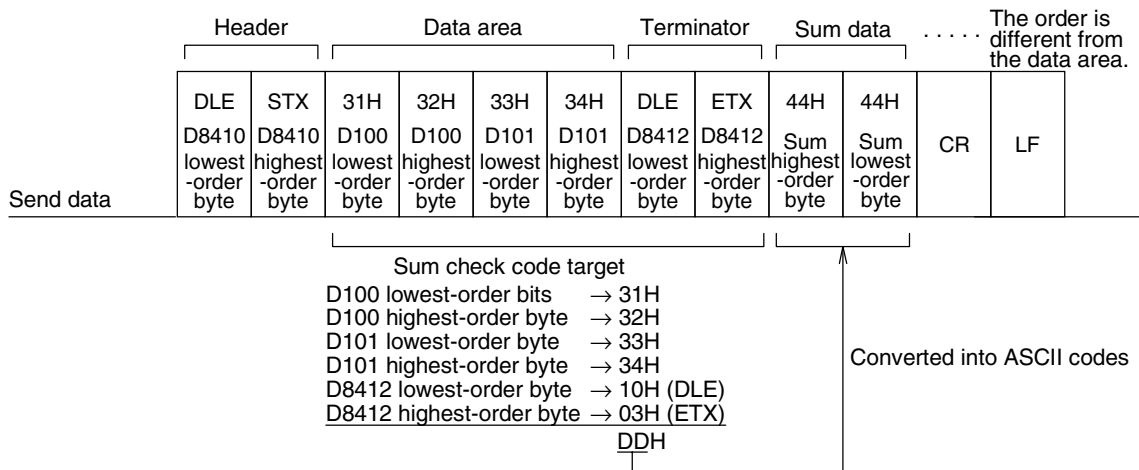

In the case of receive data

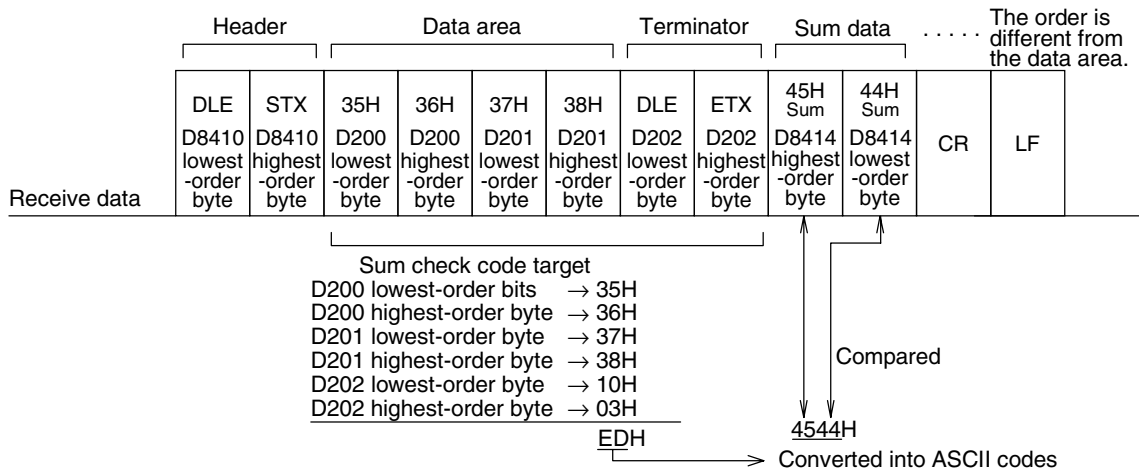

A	Common Items
B	N:N Network
C	Parallel Link
D	Computer Link
E	Inverter Communication
F	Non-Protocol Communication (RS/RS2 Instruction)
G	Non-Protocol Communication (FX2N-232IF)
H	Programming Communication
I	Remote Maintenance

8.3 Operation of Control Line

1. When the control line is not provided

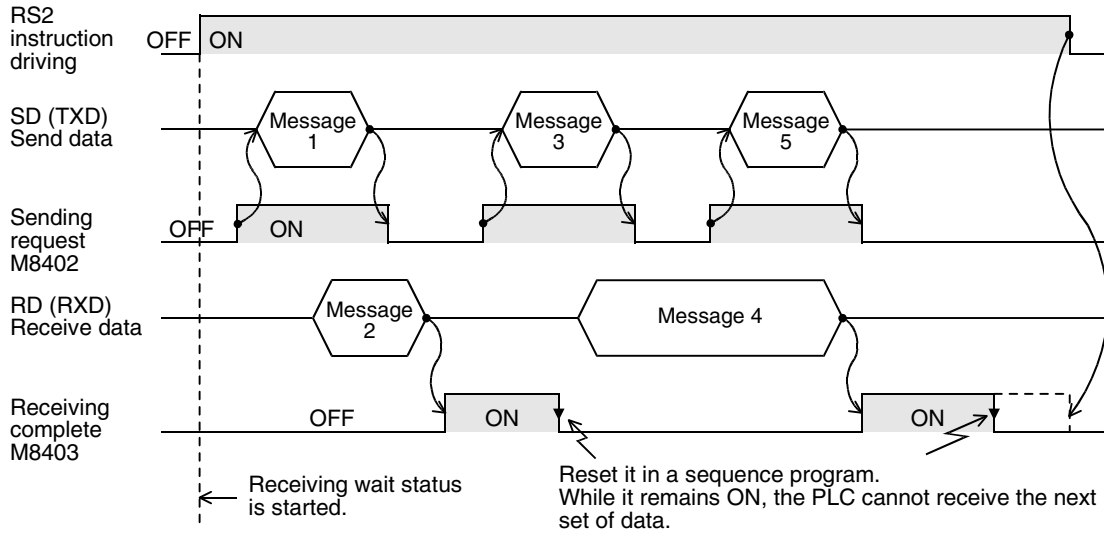

2. When the control line is in the standard mode

Use this mode when only sending or receiving.

1) When only sending is executed

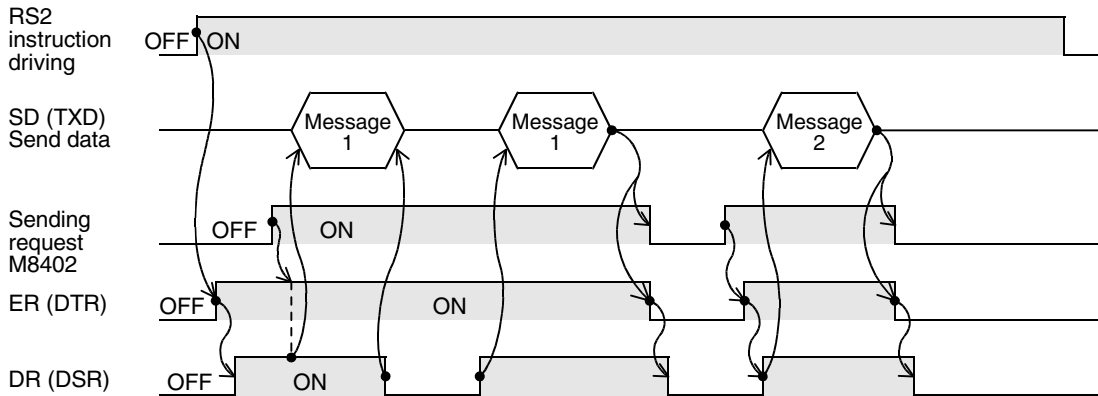

2) When only receiving is executed [The DR (DSR) signal is not used.]

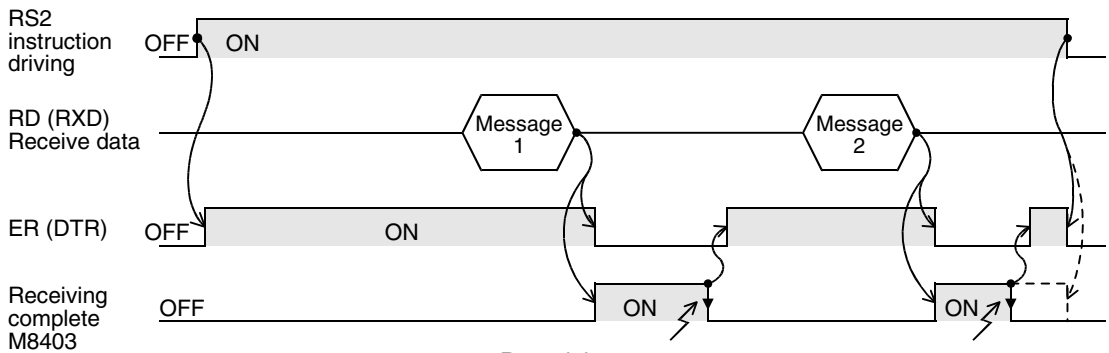

Reset it in a sequence program. While it remains ON, the PLC cannot receive the next set of data.

3. When the control line is in the modem mode

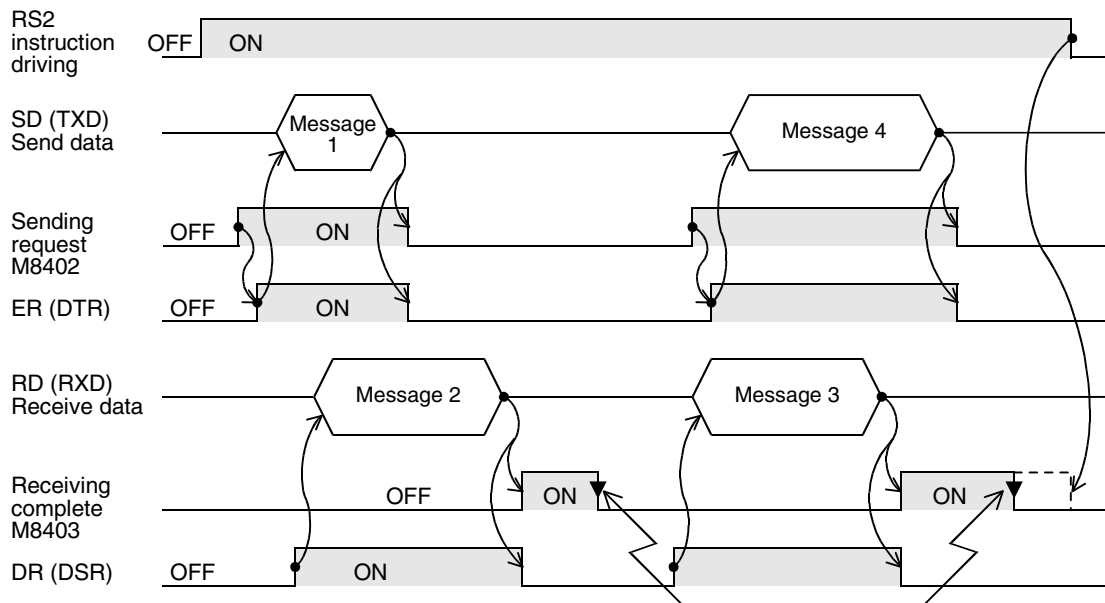

Reset it in a sequence program.
 While it remains ON, the PLC cannot receive the next set of data.

A	Common Items
B	N:N Network
C	Parallel Link
D	Computer Link
E	Inverter Communication
F	Non-Protocol Communication (RS/RS2 Instruction)
G	Non-Protocol Communication (FX2N-232IF)
H	Programming Communication
I	Remote Maintenance

4. When the control line is in the interlink mode

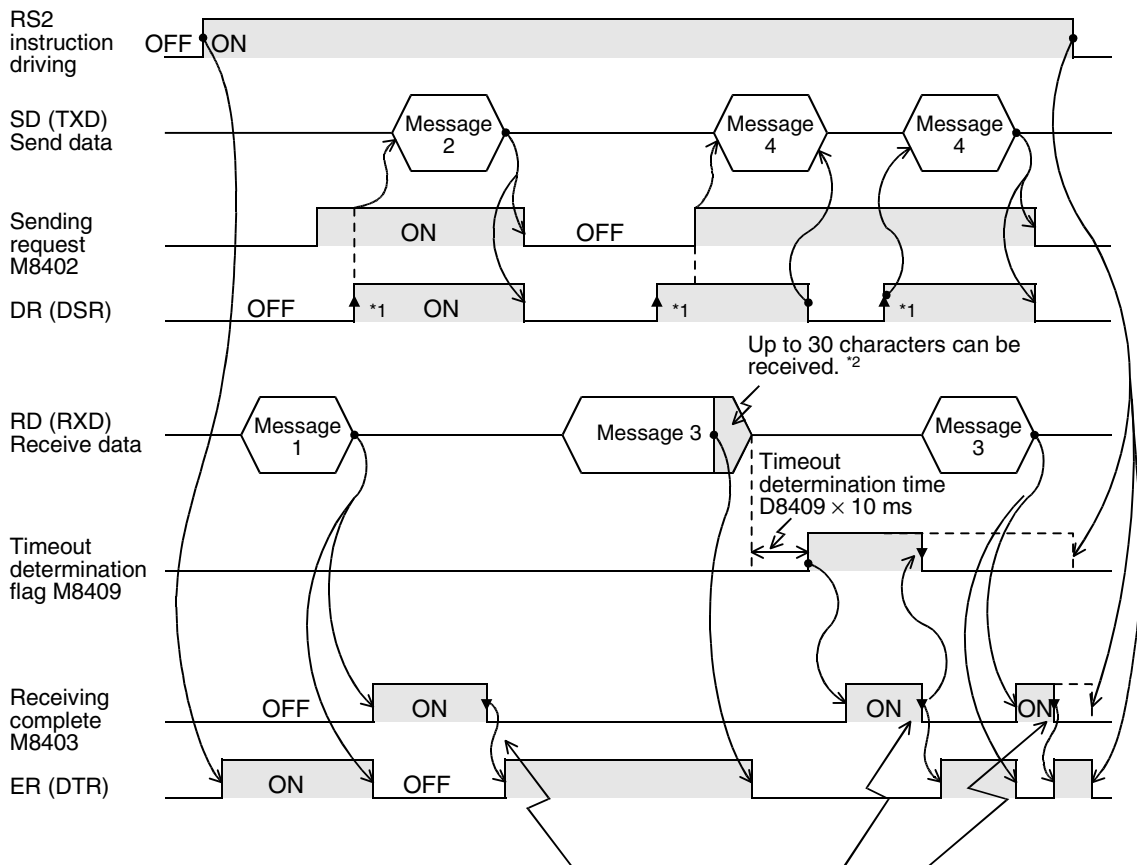

- *1. On the counterpart equipment side, set the DR (DSR) signal to ON when the PLC is ready to receive. The FX3U/FX3UC PLC sends the send data when both the DR (DSR) signal and the sending request turn ON.
- *2. In the interlink mode, the PLC sets the ER (DTR) signal to OFF 30 characters before reaching the specified amount of received data, and asks the counterpart equipment to stop sending. After that, the PLC can only receive up to 30 characters. In this case, temporarily stop sending, and then send the remaining data after the ER (DTR) signal turns ON again. When sending is stopped, the PLC finishes receiving after the timeout determination time has come. When sending is not stopped, the PLC finishes receiving after it has received the final send data or 30 characters. Accordingly, make sure that the number of receive characters are "30 + α".

8.4 Important Points in Creating Programs

- 1) RS2 instruction can be used as many times as necessary in a program, but make sure that only one RS2 instruction is driven in each communication port at a time.
 For switching RS2 instruction to be driven, provide the OFF time longer than one scan time.
- 2) Do not use another instruction (such as RS instruction or IVDR instruction) which uses the same communication port. If such an instruction is used, communication may not be executed normally.
- 3) While RS2 instruction is driven, change of D8400 or D8420 is not accepted.
 For changing D8400 or D8420, set RS2 instruction to OFF, set D8400 or D8420 to "0", and then set a new value to D8400 or D8420.
- 4) In the interlink mode, set the amount of received data "n" to "31" or more.
 If it is set to "30" or less, the control line ER (DTR) is set to OFF as soon as the PLC receives data.
- 5) FX3U and FX3UC PLCs execute full-duplex, bidirectional communication. When using half-duplex, bidirectional communication, pay attention not to turn ON the sending flag while receiving.

8.5 Communication Error

When a communication error occurs, the error flag M8063 turns ON during communication using ch1, or the error flag M8438 turns ON during communication using ch2.
 And D8063 or D8438 stores the error code.

Error code		Description
D8063 (ch1)	D8438 (ch2)	
6301	3801	Parity error, overrun error or framing error
6303	3803	Receive data sum mismatch
6304	3804	Defective data format

→ Confirm the contents in "Chapter 11. Troubleshooting".

A	Common Items
B	N:N Network
C	Parallel Link
D	Computer Link
E	Inverter Communication
F	Non-Protocol Communication (RS/RS2 Instruction)
G	Non-Protocol Communication (FX2N-232IF)
H	Programming Communication
I	Remote Maintenance

9. Practical Program Example (RS2 Instruction)

9.1 Example of Printing Using RS2 Instruction (in Connection in Accordance with RS-232C)

In this example, a printer having the RS-232C interface is connected to a PLC, and the data sent from the PLC is printed.

1. System configuration

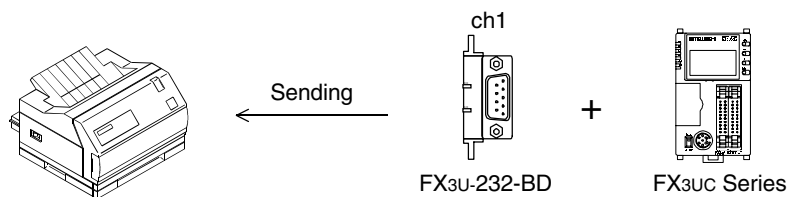

Use a communication cable suitable to the pin arrangement of the connector of the used printer.

Communication format

Align the communication format in the PLC with that in the used printer.
 (The table below shows the communication format in the main unit.)

Data length	8-bit
Parity	Even
Stop bit	2-bit
Baud rate	2400 bps
Header	Not provided
Terminator	Not provided
Control line (H/W)	Standard/RS-232C, provided
Communication method (protocol)	Non-protocol method
CR, LF	Not provided

2. Sequence program

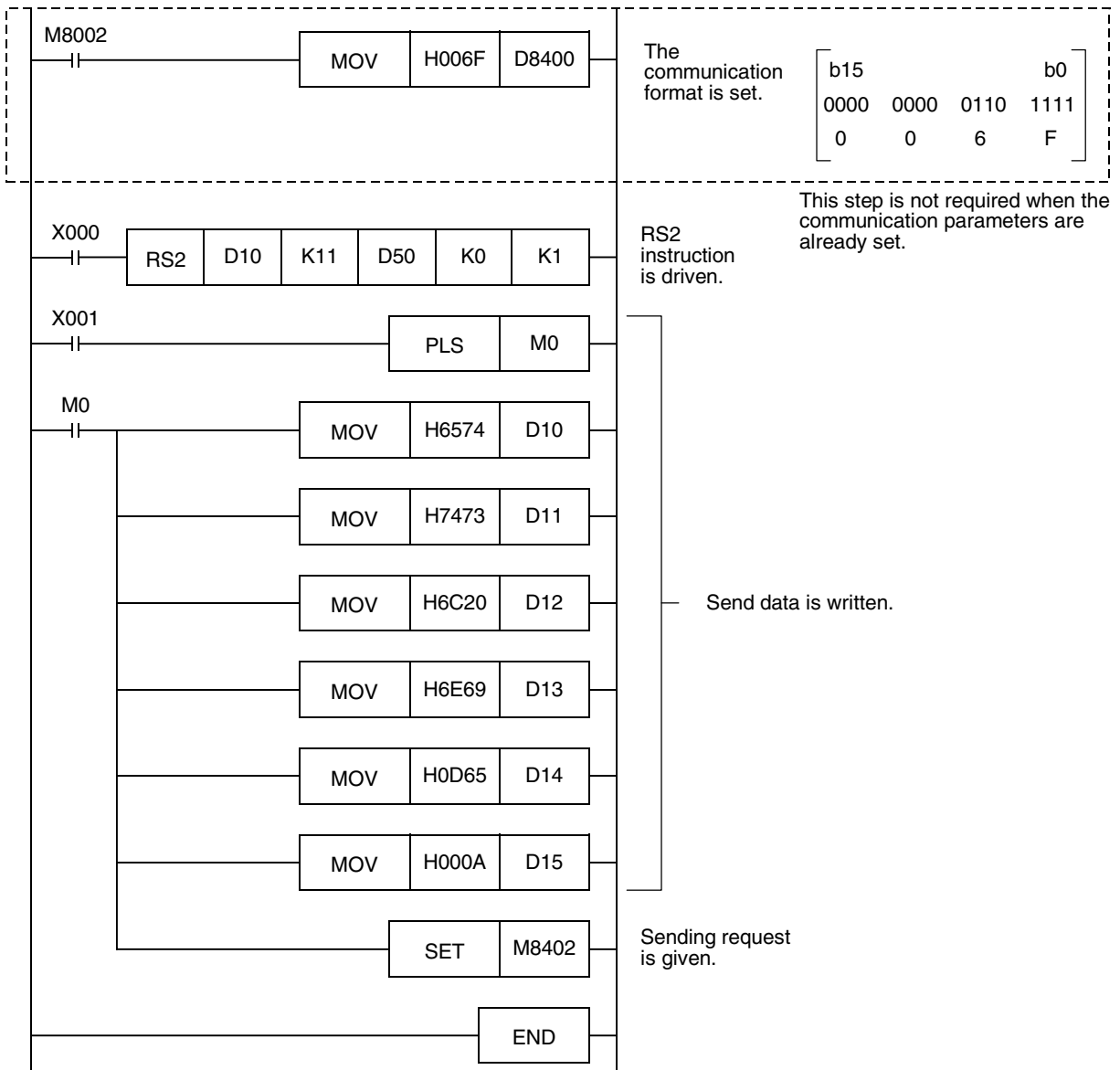

3. Operation

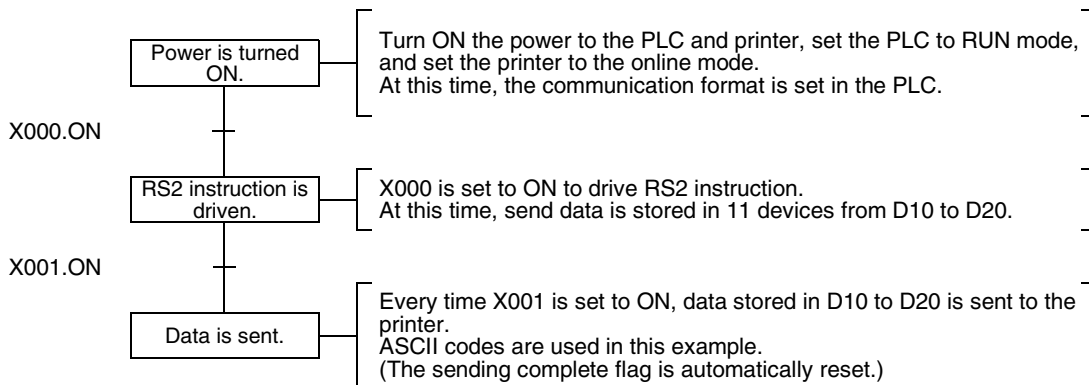

A	Common Items
B	N:N Network
C	Parallel Link
D	Computer Link
E	Inverter Communication
F	Non-Protocol Communication (RS/RS2 Instruction)
G	Non-Protocol Communication (FX2N-232IF)
H	Programming Communication
I	Remote Maintenance

10. When Combined with Another Communication

This chapter explains how to use non-protocol communication (RS or RS2 instruction) together with another communication type.

10.1 Other Communication Type Used Together

In FX PLCs, the following communication types can be changed over.

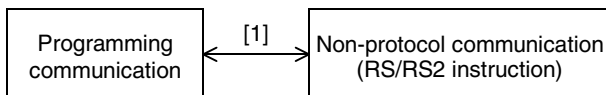

[1] Applicable only in FX2N (Ver. 2.01 or later), FX3U, FX2NC, and FX3UC PLCs.

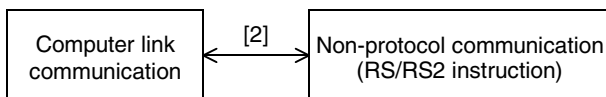

[2] Applicable only in FX3U and FX3UC PLCs.

When changing over the above communication types, it is necessary to set the communication using a sequence program.

The tables below show devices used in sequence programs.

1) RS instruction

Device	Name	Description
D8120	Communication format setting	Sets the communication format.
D8419	Operation mode display (in FX3U and FX3UC)	Allows the communication type being executed to be checked.

2) RS2 instruction

Device		Name	Description
ch1	ch2		
D8400	D8420	Communication format setting	Sets the communication format.
D8419	D8439	Operation mode display	Allows the communication type being executed to be checked.

→ For the communication setting method, refer to Section 10.6.

→ For details on the operation mode display, refer to Subsection 11.4.1.

10.2 When Combined with Programming Communication

In FX2N (Ver. 2.01 or later), FX3U, FX2NC, and FX3UC PLCs, non-protocol communication in accordance with RS-232C using RS instruction can be changed over to the programming communication for peripheral equipment.

10.2.1 For FX2N and FX2NC PLCs

In FX2N (Ver. 2.01 or later) and FX2NC PLCs, non-protocol communication using RS instruction by way of RS-232C port in the FX2N-232-BD (for FX2N PLCs), FX0N-232ADP, or FX2NC-232ADP can be changed over to the communication with a programming tool (programming communication) in the following methods. If the counterpart equipment executes another type of communication while the programming communication is selected, the PLC sends back "NAK".

1. When changing over using RUN mode and STOP mode

Set the communication format to one of the settings shown below for executing non-protocol communication (in accordance with RS-232C) using RS instruction in RUN mode and executing the programming communication in STOP mode.

Item	Contents			
	H0086	H0186	H0286	H0386
Data length	7-bit			
Parity bit	Even			
Stop bit	1-bit			
Baud rate (bps)	9600 bps			
Header	Not provided	Provided	Not provided	Provided
Terminator	Not provided		Provided	
Control line	Not provided			

2. When changing over by RS instruction in RUN mode

When changing over non-protocol communication using RS instruction to the programming communication in RUN mode, set RS instruction to OFF, and then overwrite the communication format (D8120) to "H0000". Before starting up RS instruction again, make sure to properly overwrite the communication format (D8120) used in RS instruction.

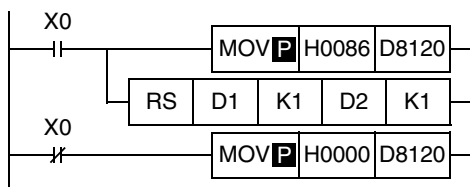

In this setting also, the communication mode can be changed over using RUN mode and STOP mode if the condition shown in 1 above is satisfied.

3. Caution on using RS instruction and programming communication together

Do not use the communication setting by parameters. Use the communication format device (D8120).

10.2.2 For FX3U and FX3UC PLCs

In FX3U and FX3UC PLCs, non-protocol communication using RS instruction can be changed over to the communication with a programming tool (programming communication) in the following methods.

If the counterpart equipment executes another type of communication while the programming communication is selected, the PLC sends back "NAK".

In FX3U and FX3UC PLCs, the communication type operating in the communication port can be checked in the operation mode display device (D8419).

1. When changing over using RUN mode and STOP mode

Set the communication format as shown below for executing non-protocol communication (in accordance with RS-232C) using RS instruction in RUN mode and executing the programming communication in STOP mode. Make sure to set the communication format used in RS instruction to D8120, and write it before executing the RS instruction.

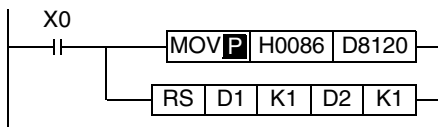

2. When changing over by RS instruction in RUN mode

When changing over non-protocol communication using RS instruction to the programming communication in RUN mode, set RS instruction to OFF, and then overwrite the communication format (D8120) to "H0000". Before starting up RS instruction again, make sure to properly overwrite the communication format (D8120) used in RS instruction.

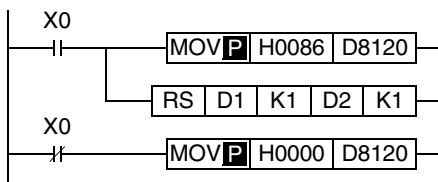

3. Caution on using RS instruction and programming communication together

Do not use the communication setting by parameters. Use the communication format device (D8120).

10.3 When Combined with Computer Link Communication (Only in FX3U and FX3UC)

In FX3U and FX3UC PLCs, non-protocol communication (in accordance with RS-232C or RS-485) using RS instruction can be changed over to a protocol dedicated to computer link in the following methods. The protocol supported by the communication port can be checked in the operation mode display device (D8149).

1. When changing over using RUN mode and STOP mode

Set the communication format as shown below for executing non-protocol communication (in accordance with RS-232C or RS-485) using RS instruction in RUN mode and executing computer link in STOP mode. Set computer link using parameters.

Make sure to set the communication format used in THE RS instruction to D8120, and write it before executing the RS instruction.

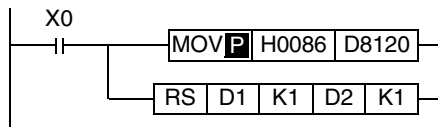

2. When changing over by RS instruction in RUN mode

When changing over non-protocol communication using RS instruction to computer link in RUN mode, set RS instruction to OFF, and then overwrite the communication format (D8120) to "H0000".

Set computer link using parameters.

Before starting up RS instruction again, make sure to properly overwrite the communication format (D8120) used in RS instruction.

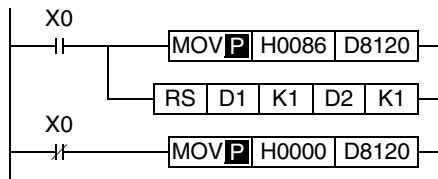

A

Common Items

B

N:N Network

C

Parallel Link

D

Computer Link

E

Inverter Communication

F

Non-Protocol Communication (RS/RS2 Instruction)

G

Non-Protocol Communication (FX2N-232IF)

H

Programming Communication

I

Remote Maintenance

10.4 When Combined with Programming Communication

In FX3U and FX3UC PLCs, non-protocol communication using RS2 instruction can be changed over to the communication with a programming tool (programming communication) in the following methods.

If the counterpart equipment executes another type of communication while the programming communication is selected, the PLC sends back "NAK".

In FX3U and FX3UC PLCs, the communication type operating in the communication port can be checked in the operation mode display devices (D8419 and D8439).

1. When changing over using RUN mode and STOP mode

Set the communication format as shown below for executing non-protocol communication (in accordance with RS-232C) using RS2 instruction in RUN mode and executing the programming communication in STOP mode.

Make sure to set the communication format used in RS2 instruction to D8400 or D8420, and write it before executing RS2 instruction.

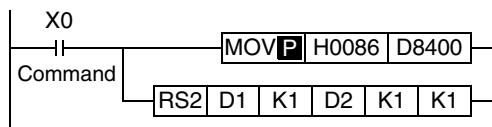

2. When changing over by RS2 instruction in RUN mode

When changing over non-protocol communication using RS2 instruction to the programming communication in RUN mode, set the RS2 instruction to OFF, and then overwrite the communication format (D8400 or D8420) to "H0000".

Before starting up RS2 instruction again, make sure to properly overwrite the communication format (D8400 or D8420) used in the RS2 instruction.

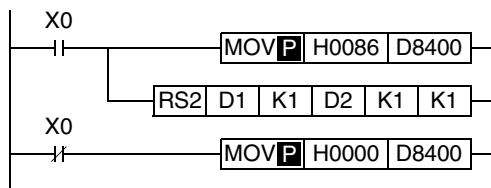

3. Caution on using RS2 instruction and programming communication together

Do not use the communication setting by parameters. Use the communication format device (D8400 or D8420).

10.5 Using RS2 Instruction and Computer Link Communication Together

In FX3U and FX3UC PLCs, non-protocol communication (in accordance with RS-232C or RS-485) using RS2 instruction can be changed over to computer link in the following methods.

In FX3U and FX3UC PLCs, the communication type operating in the communication port can be checked in the operation mode display devices (D8419 and D8439).

1. When changing over using RUN mode and STOP mode

Set the communication format as shown below for executing non-protocol communication (in accordance with RS-232C) using RS2 instruction in RUN mode and executing a protocol for computer link in STOP mode.

Set computer link using parameters.

Make sure to set the communication format used in RS2 instruction to D8400 or D8420, and write it before executing RS2 instruction.

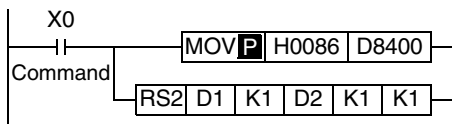

Non-protocol communication (in accordance with RS-485) cannot be changed over to computer link using RUN mode and STOP mode.

When changing over non-protocol communication (in accordance with RS-485) to computer link, refer to "2. When changing over the communication by executing RS2 instruction in RUN mode" below.

2. When changing over by RS2 instruction in RUN mode

When changing over non-protocol communication using RS2 instruction to computer link in RUN mode, set RS2 instruction to OFF, and then overwrite the communication format (D8400 or D8420) to "H0000".

Set computer link using parameters.

Before starting up RS2 instruction again, make sure to properly overwrite the communication format (D8400 or D8420) used in RS2 instruction.

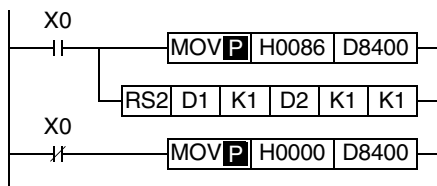

A	Common Items
B	N:N Network
C	Parallel Link
D	Computer Link
E	Inverter Communication
F	Non-Protocol Communication (RS/RS2 Instruction)
G	Non-Protocol Communication (FX2N-232IF)
H	Programming Communication
I	Remote Maintenance

10.6 Communication Setting Method Using Sequence Program

In the setting method using a sequence program, transfer values to the communication format device (D8120, D8400 or D8420).

This section explains related devices and the setting method using a sequence program.

10.6.1 Communication setting for RS instruction

The following device is used in the communication setting.

1. D8120 (communication format)

By setting values to D8120, the data length, parity, baud rate, etc. can be set. The table below shows the contents of D8120.

Bit No.	Name	Contents	
		0 (bit = OFF)	1 (bit = ON)
b0	Data length	7-bit	8-bit
b1 b2	Parity	b2, b1 (0, 0): Not provided (0, 1): Odd (1, 1): Even	
b3	Stop bit	1-bit	2-bit
b4 b5 b6 b7	Baud rate (bps)	b7, b6, b5, b4 (0, 0, 1, 1): 300 (0, 1, 0, 0): 600 (0, 1, 0, 1): 1200 (0, 1, 1, 0): 2400	b7, b6, b5, b4 (0, 1, 1, 1): 4800 (1, 0, 0, 0): 9600 (1, 0, 0, 1): 19200
b8	Header	Not provided	Provided (D8124) initial value: STX (02H)
b9	Terminator	Not provided	Provided (D8125) initial value: ETX (03H)
b10 b11	Control line	Non-protocol communication	b11, b10 (0, 0): Not provided <RS-232C interface> (0, 1): Standard mode <RS-232C interface> (1, 0): Interlink mode <RS-232C interface> (FX2N whose version is Ver. 2.00 or later, FX3U, FX2NC, and FX3UC) (1, 1): Modem mode <RS-232C interface, RS-485/RS-422 interface*2>
		Computer link	b11, b10 (0, 0): RS-485/RS-422 interface (1, 0): RS-232C interface
b12		Not applicable	
b13*1	Sum check	Not added	Added
b14*1	Protocol	Not used	Used
b15*1	Control procedure	Format 1	Format 4

*1. Make sure to set as "0" when using non-protocol communication.

*2. When using the RS-485/RS-422 interface, only FX1S, FX0N, FX1N, FX2N, FX3U, FX1NC, FX2NC, and FX3UC PLCs are applicable.

For setting the communication type, make the following program.

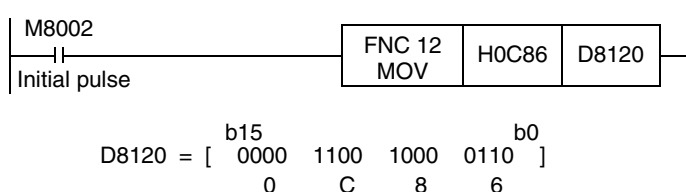

Data length	7-bit
Parity	Even
Stop bit	1-bit
Baud rate	9600 bps
Protocol	Non-protocol
Header	Not provided
Terminator	Not provided
Control line	Modem mode

10.6.2 Communication setting for RS2 instruction

The following devices are used in the communication setting.
 When using the communication port (ch1), set D8400.
 When using the communication port (ch2), set D8420.

1. D8400 and D8420 (communication format)

By setting values to D8400 or D8420, the data length, parity, baud rate, etc. can be set.
 The table below shows the contents of D8400 and D8420.

Bit No.	Name	Contents	
		0 (bit = OFF)	1 (bit = ON)
b0	Data length	7-bit	8-bit
b1 b2	Parity	b2, b1 (0, 0): Not provided (0, 1): Odd (1, 1): Even	
b3	Stop bit	1-bit	2-bit
b4 b5 b6 b7	Baud rate (bps)	b7, b6, b5, b4 (0, 0, 1, 1): 300 (0, 1, 0, 0): 600 (0, 1, 0, 1): 1200 (0, 1, 1, 0): 2400	b7, b6, b5, b4 (0, 1, 1, 1): 4800 (1, 0, 0, 0): 9600 (1, 0, 0, 1): 19200
b8	Header	Not provided	Provided*2
b9	Terminator	Not provided	Provided*2
b10 b11 b12	Control line	Non-protocol communication	b12, b11, b10 (0, 0, 0): Not provided <RS-232C interface> (0, 0, 1): Standard mode <RS-232C interface> (0, 1, 0): Interlink mode <RS-232C interface> (0, 1, 1): Modem mode <RS-232C interface> (1, 1, 1): Communication in accordance with RS-485 <RS-485/RS-422 interface>
b13	Sum check	Not added	Added*3
b14*1	Protocol	Not used	Used
b15	Control procedure (CR, LF)	CR, LF: Not used (Format 1)	CR, LF: Used (Format 4)

- *1. Make sure to set as "0" when using non-protocol communication.
- *2. In RS2 instruction, up to four headers and up to four terminators can be set.
- *3. When executing non-protocol communication using RS2 instruction, add the sum check code after the terminators.
 Make sure to set the terminators when adding the sum check code.

For setting the communication type, make the following program.

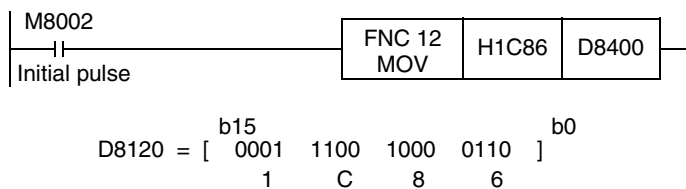

Data length	7-bit
Parity	Even
Stop bit	1-bit
Baud rate	9600 bps
Protocol	Non-protocol
Header	Not provided
Terminator	Not provided
Control line	Communication in accordance with RS-485

11. Troubleshooting

This chapter explains troubleshooting and error codes.

11.1 Checking FX PLC Version Applicability

Verify that the FX PLC main unit is an applicable version in non-protocol communication.

→ For the version applicability, refer to Section 1.3.

11.2 Checking Communication Status Based on LED Indication

Check the status of the "RD" and "SD" indicator LEDs provided in the optional equipment.

LED status		Operation status
RD	SD	
Flashing	Flashing	Data is being sent or received.
Flashing	Off	Data is received, but is not sent.
Off	Flashing	Data is sent, but is not received
Off	Off	Data is not sent nor received.

11.3 Checking Installation

1. Mounting status

If the communication equipment is not securely connected to the PLC, communication is disabled.

→ For the mounting method, refer to the manual of each communication equipment.

2. Power supply (for FX0N-485ADP)

The FX0N-485ADP requires a driving power supply. Verify that the power supply is provided correctly.

3. Wiring

Verify that the wiring to each communication equipment is correct. Incorrect wiring disables communication.

→ For the wiring method check, refer to Chapter 4.

11.4 Checking Sequence Program

1. Communication settings in a sequence program

Verify that N:N Network (D8176 to D8180) and parallel link (M8070 and M8071) are not set.
 Verify that the communication format (D8120, D8400 or D8420) is set correctly. If a communication port is set more than once, communication is disabled.
 After changing any settings, make sure to turn OFF the PLC power, and then turn it ON again.

2. Communication settings using parameters

Verify that the communication settings using parameters are correct. If the contents of the settings do not agree, communication is not executed correctly.
 After changing any settings, make sure to turn OFF the PLC power, and then turn it ON again.

3. Presence of VRRD and VRSC instructions (except FX3U and FX3UC PLCs)

Verify that VRRD and VRSC instructions are not used in a program.
 If these instructions are used, delete them, turn OFF the PLC power, and then turn it ON again.

4. Presence of IVCK, IVDR, IVRD, IVWR, and IVBWR instructions (in FX3U and FX3UC PLCs)

Verify that IVCK, IVDR, IVRD, IVWR and IVBWR instructions are not used in the same channel.
 If these instructions are used in the same channel, delete them, turn OFF the PLC power, and then turn it ON again.

5. Presence of EXTR instruction (in FX2N and FX2NC PLCs)

Verify that EXTR instruction is not used in a program.
 If this instruction is used, delete it, turn OFF the PLC power, and then turn it ON again.

6. Presence of RS and RS2 instruction

Verify that two or more RS/RS2 instructions are not driven in the same channel.
 If two or more RS/RS2 instructions are driven, modify the program so that only one RS/RS2 instruction is driven.

11.4.1 Checking communication port settings (in FX3U and FX3UC PLCs)

1. Checking the operation mode

In FX3U and FX3UC PLCs, the communication port operation status can be checked.
 D8419 stores the communication type code currently adopted in the communication port (ch1).
 D8439 stores the communication type code currently adopted in the communication port (ch2).
 The table below shows the contents of the communication type codes.

Code	Description
0	Programming communication
2	Protocol dedicated to computer link
3	N:N Network
4	RS instruction
5	RS2 instruction
6	Parallel link
7	Inverter instruction

If the operation mode is different, check the parameters and sequence programs.

A	Common Items
B	N:N Network
C	Parallel Link
D	Computer Link
E	Inverter Communication
F	Non-Protocol Communication (RS/RS2 Instruction)
G	Non-Protocol Communication (FX2N-232IF)
H	Programming Communication
I	Remote Maintenance

11.5 Checking Absence/Presence of Errors

1. Checking for communication errors

When a communication error occurs, the serial communication error flag turns ON.

In all PLCs except FX3U and FX3UC PLCs and when the communication port (ch1) is used in FX3U and FX3UC PLCs, M8063 turns ON.

When the communication port (ch2) is used in FX3U and FX3UC PLCs, M8438 turns ON.

When the serial communication error flag turns ON, D8063 or D8438 stores the corresponding error code.

2. Checking the error code

When the serial communication error flag turns ON, a corresponding error code shown below is stored in D8063 or D8438.

Error code		Contents of error
ch1 (D8063)	ch2 (D8438)	
6301	3801	Parity error, overrun error or framing error
6302	3802	Defective communication character
6303	3803	Communication data sum mismatch
6304	3804	Defective data format
6305	3805	Defective command
6306	3806	Monitoring timeout
6307	3807	Modem initialization error
6308	3808	N:N Network parameter error
6312	3812	Parallel link parameter error
6313	3813	Parallel link sum error
6314	3814	Parallel link format error
6320	3820	Error in communication with inverter

When an error code above is stored, check the following items:

- Wiring
- Parameter settings

12. Related Data

12.1 Related Device List (RS Instruction)

1. Bit devices

R: Read, W: Write

Device	Name	Description	Attribute
M8063	Serial communication error flag	This device turns ON when a communication error occurs.	R
M8120	Communication setting keep	This device keeps the communication setting status (for FX0N PLC).	W
M8121	Sending wait flag	This device remains ON while the PLC is waiting to send.	R
M8122	Sending request	When this device is set to ON by SET instruction, the PLC starts to send.	R/W
M8123	Receiving complete flag	This device turns ON when receiving is completed.	R/W
M8124	Carrier detection flag	This device turns ON and OFF in synchronization with the CD signal.	R
M8129*1	Timeout determination flag	This device turns ON when data receiving is suspended and the next set of receive data is not given within the time set by the timeout determination time setting device (D8129).	R/W
M8161	8-bit processing mode	This device sets the send/receive data to 16-bit data or 8-bit data.	W

*1. Not provided in FX0N, FX2(FX), FX2C, and FX2N (before Ver. 2.00) PLCs.

2. Word devices

R: Read, W: Write

Device	Name	Description	Attribute
D8063	Serial communication error code	When the serial communication error flag (M8063) turns ON, this device stores the corresponding error code.	R/W
D8120	Communication format setting	This device sets the communication format.	R/W
D8122	Amount of remaining send data	This device stores the amount of remaining send data.	R
D8123	Amount of data already received	This device stores the amount of data already received.	R
D8124	Header	This device sets the header (initial value: STX (H02)).	R/W
D8125	Terminator	This device sets the terminator (initial value: ETX (H03)).	R/W
D8129*1	Timeout determination time setting	This device sets the timeout time.	R/W
D8405*2	Communication parameter display	This device stores communication parameters set in the PLC.	R
D8419*2	Operation mode display	This device stores the communication type being used.	R

*1. Not provided in FX0N, FX2(FX), FX2C, and FX2N (before Ver. 2.00) PLCs.

*2. Provided only in FX3U and FX3UC PLCs.

12.2 Details of related devices (RS instruction)

This section explains devices used in non-protocol communication.

12.2.1 Serial communication error [M8063]

This device turns ON when an error occurs in serial communication.

1. Detailed contents

This device works as the serial communication error flag.
When this device turns ON, a corresponding error code is stored in D8063.

2. Cautions on use

The serial communication error flag does not turn OFF even after communication recovers its normal status.
Clear it by changing the PLC mode from STOP to RUN.

12.2.2 Communication setting keep [M8120]

Set this device to ON in a sequence program so that the communication setting is kept (for FX0N PLCs).

1. Detailed contents

In FX0N PLCs, set M8120 to ON in a sequence program so that the communication format setting is kept.

2. Cautions on use

In FX0N PLCs, the communication setting status is kept only when M8120 is set to ON.
In any PLC other than the FX0N PLCs, setting of M8120 is not required.

12.2.3 Sending wait flag [M8121]

This device remains ON while the PLC is waiting to send.

1. Detailed contents

- In full-duplex communication in FX3U and FX3UC PLCs
While the control line is set to the standard or interlink mode in a communication parameter, when the control line DR (DSR) turns OFF while sending data, the PLC waits to send and M8121 turns ON.
- In full-duplex communication in all PLCs except FX3U and FX3UC PLCs
M8121 does not turn ON.
- In half-duplex communication
When the sending request device is set to ON while data is being received, the PLC waits to send and M8121 turns ON.

12.2.4 Sending request [M8122]

When this device is set to ON by SET instruction, the PLC starts to send.

1. Detailed contents

When this device is set to ON by SET instruction, the PLC starts to send. When sending is completed, this device is automatically set to OFF.

2. Cautions on use

When setting this device to ON, set the drive condition in the pulse type.
In FX2(FX), FX2C, FX1S, FX0N, FX1N, FX1NC, and FX2N (before Ver. 2.00) PLCs, note the following contents:

- While the PLC is receiving data, next data is sent after the receiving is finished. During this period, the sending wait flag remains ON.
- From when the head data is received until the receiving complete flag turns ON, it is regarded that data is being received. If a sending request is given while the head data is being received, data is confused.

A	Common Items
B	N:N Network
C	Parallel Link
D	Computer Link
E	Inverter Communication
F	Non-Protocol Communication (RS/RS2 Instruction)
G	Non-Protocol Communication (FX2N-232IF)
H	Programming Communication
I	Remote Maintenance

12.2.5 Receiving complete flag [M8123]

This device turns ON when receiving is completed.

1. Detailed contents

This device turns ON when receiving is completed.
 Receiving is completed in one of the following three conditions.

- When the PLC receives as many receive data as specified by RS instruction
- When "terminator provided" is selected in the communication format, and the PLC receives the code set in the terminator
- When data receiving is suspended and the PLC does not receive the next set of data within the time set in the timeout determination time setting device
 When the receiving complete flag turns ON, transfer the received data to another storage destination, and then set this flag to OFF.
 When this flag is set to OFF, the PLC waits to receive.

2. Cautions on use

When RS instruction is driven while the amount of received data is set to "0", the PLC does not wait to receive. In such a case, set the amount of received data to "1" or more, set the receiving complete flag to ON, and then set it to OFF.

12.2.6 Carrier detection flag [M8124]

This device turns ON and OFF in synchronization with the CD (DCD) signal.

1. Detailed contents

The CD (DCD) signal (channel receiving carrier detection) turns ON when the modem line is established. While the carrier detection flag is OFF, the dial number can be sent. While the carrier detection flag is ON, data can be sent and received.

12.2.7 Timeout determination flag [M8129]

This device turns ON when data receiving is suspended, and the next set of receive data is not given within the time set by the timeout determination time setting device.

1. Detailed contents

This device turns ON when data receiving is suspended and the next set of receive data is not given within the time set by the timeout determination time setting device. And the receiving complete flag turns ON also. The timeout determination flag turns OFF when the PLC waits to receive. By using this function, the PLC can receive data without the terminator from such equipment where the number of send data varies.

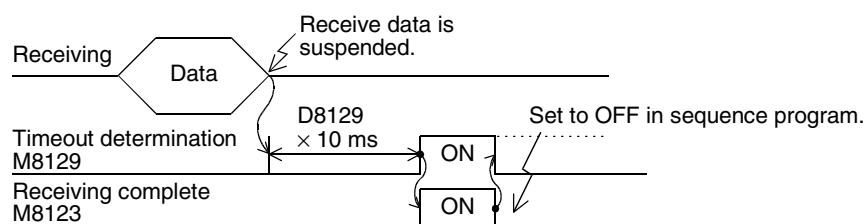

12.2.8 Serial communication error code [D8063]

When a serial communication error occurs, this device stores the corresponding error code.

1. Detailed contents

When a serial communication error occurs, this device stores the corresponding error code shown below.

Error code	Contents of error
6301	Parity error, overrun error or framing error
6302	Defective communication character
6303	Communication data sum mismatch
6304	Defective data format
6305	Defective command
6306	Monitoring timeout
6307	Modem initialization error
6308	N:N Network parameter error
6312	Parallel link character error
6313	Parallel link sum error
6314	Parallel link format error
6320	Error in communication with inverter

2. Cautions on use

The serial communication error code is not cleared even after communication recovers its normal status. Clear it by changing the PLC mode from STOP to RUN.

12.2.9 Communication format setting [D8120]

This device sets the communication format.

1. Detailed contents

This device can set the data length, parity, baud rate, etc.

The table below shows the contents of the communication format setting.

Bit No.	Name	Contents	
		0 (bit = OFF)	1 (bit = ON)
b0	Data length	7-bit	8-bit
b1 b2	Parity	b2, b1 (0, 0): Not provided (0, 1): Odd (1, 1): Even	
b3	Stop bit	1-bit	2-bit
b4 b5 b6 b7	Baud rate (bps)	b7, b6, b5, b4 (0, 0, 1, 1): 300 (0, 1, 0, 0): 600 (0, 1, 0, 1): 1200 (0, 1, 1, 0): 2400	b7, b6, b5, b4 (0, 1, 1, 1): 4800 (1, 0, 0, 0): 9600 (1, 0, 0, 1): 19200
b8	Header	Not provided	Provided (D8124) Initial value: STX (02H)
b9	Terminator	Not provided	Provided (D8125) Initial value: ETX (03H)
b10 b11	Control line	Non-protocol communication	b11, b10 (0, 0): Not provided <RS-232C interface> (0, 1): Standard mode <RS-232C interface> (1, 0): Interlink mode <RS-232C interface> (FX2N whose version is Ver. 2.00 or later, FX3U, FX2NC, and FX3UC) (1, 1): Modem mode <RS-232C interface, RS-485/RS-422 interface *2>
		Computer link	b11, b10 (0, 0): RS-485/RS-422 interface (1, 0): RS-232C interface
b12		Not applicable	
b13*1	Sum check	Not added	Added
b14*1	Protocol	Not used	Used
b15*1	Control procedure	Format 1	Format 4

*1. Make sure to set as "0" when using non-protocol communication.

*2. When using the RS-485/RS-422 interface, only FX1S, FX0N, FX1N, FX2N, FX3U, FX1NC, FX2NC, and FX3UC PLCs are applicable.

2. Cautions on use

In all PLCs except FX2(FX), FX2C, and FX0N PLCs, the communication format can be set using parameters. When setting the communication format in FX0N PLCs, set the communication setting latched (battery backed) device (M8120) to ON.

12.2.10 Amount of remaining send data [D8122]

This device stores the amount of remaining send data.

1. Detailed contents

This device stores the amount of remaining send data in 8-bit (1 byte) units. Only data in communication frames are regarded as targets of counting.

A Common Items
 B N:N Network
 C Parallel Link
 D Computer Link
 E Inverter Communication
 F Non-Protocol Communication (RS/RS2 Instruction)
 G Non-Protocol Communication (FX2N-232IF)
 H Programming Communication
 I Remote Maintenance

12.2.11 Amount of data already received [D8123]

This device stores the amount of data already received.

1. Detailed contents.

This device stores the amount of data already received in 8-bit (1 byte) units.

12.2.12 Header [D8124]

This device sets the header.

1. Detailed contents

When "header provided" is selected in the communication format setting, the lowest-order byte of D8124 is used.

When data is sent, the data in the lowest-order byte of D8124 is added at the head of the specified send data.

When data is received, receiving begins when the data in the lowest-order byte of D8124 is received.

12.2.13 Terminator [D8125]

This device sets the terminator.

1. Detailed contents

When "terminator provided" is selected in the communication format setting, the lowest-order byte of D8125 is used.

When data is sent, the lowest-order byte of D8125 is added at the end of the specified send data.

When data is received, receiving is completed when the data in the lowest-order byte of D8125 is received.

12.2.14 Timeout determination time [D8129]

This device sets the timeout determination time.

1. Detailed contents

This device sets the error evaluation time (in units of 10 ms) used when receiving of data is interrupted.

The setting range is from 1 to 255 (10 ms to 2550 ms).

2. Cautions on use

In all PLCs except FX2(FX), FX2C, and FX0N PLCs, the timeout determination time can be set using a parameter.

When setting the timeout determination time in FX0N PLCs, set the communication setting latched (battery backed) device (M8120) to ON.

12.2.15 Communication parameter display [D8405]

This device stores the communication parameters set in the PLC (in FX3U and FX3UC PLCs).

1. Detailed contents

When the PLC power is turned ON, D8405 stores the contents of the communication parameters.

The contents of the parameters are the same as those of the communication format setting device (D8120).

12.2.16 Operation mode display [D8419]

This device stores the communication type being used.

1. Detailed contents

This device stores the code of the communication type currently being used in the communication port. The table below shows the contents of the codes.

Code	Description
0	Programming communication
2	Protocol dedicated to computer link
3	N:N Network
4	RS instruction
5	RS2 instruction
6	Parallel link
7	Inverter instruction

2. Cautions on use

This device stores "4" while RS instruction is driven or when RS instruction is not changed over to another mode.

12.3 Related Devices (RS2 Instruction)

1. Bit devices

R: Read, W: Write

	Device		Name	Description	Attribute
	ch1	ch2			
	M8063	M8438	Serial communication error	This device turns ON when a communication error occurs. When this device (serial communication error) turns ON, D8063 or D8438 stores the corresponding error code.	R
	M8401	M8421	Sending wait flag	This device remains ON while the PLC is waiting to send.	R
	M8402	M8422	Sending request	When this device is set to ON, the PLC starts to send.	R/W
	M8403	M8423	Receiving complete flag	This device turns ON when receiving is completed. While this device (receiving complete flag) is ON, the PLC cannot receive any receive data.	R/W
	M8404	M8424	Carrier detection flag	This device turns ON in synchronization with the CD (DCD) signal.	R
*1	M8405	M8425	Data set ready (DSR) flag	This device turns ON in synchronization with the DR (DSR) signal.	R
	M8409	M8429	Timeout determination flag	This device turns ON when data receiving is suspended and the next set of receive data is not given within the time set by the timeout time setting device.	R/W

*1. Available in Ver.2.30 or later of FX3U or FX3UC PLC

2. Word devices

R: Read, W: Write

Device		Name	Description	Attribute
ch1	ch2			
D8063	D8438	Serial communication error code	When the serial communication error flag turns ON, this device stores the corresponding error code.	R/W
D8400	D8420	Communication format setting	This device sets the communication format.	R/W
D8402	D8422	Amount of remaining send data	This device stores the amount of remaining send data.	R
D8403	D8423	Amount of data already received	This device stores the amount of data already received.	R
D8405	D8425	Communication parameter display	This device stores communication parameters set in the PLC.	R
D8409	D8429	Timeout time setting	This device sets the timeout time.	R/W
D8410	D8430	Header 1 and header 2	These devices set the headers 1 to 4.	R/W
D8411	D8431	Header 3 and header 4		R/W
D8412	D8432	Terminator 1 and terminator 2	These devices set the terminators 1 to 4.	R/W
D8413	D8433	Terminator 3 and terminator 4		R/W
D8414	D8434	Receiving sum (receive data)	This device stores the received sum check value.	R
D8415	D8435	Receiving sum (calculation result)	This device stores the sum check value calculated from the received data.	R
D8416	D8436	Sending sum	This device stores the sum check value added to the send data.	R
D8419	D8439	Operation mode display	This device stores the communication type being used.	R

12.4 Details of Related Devices (RS2 Instruction)

12.4.1 Serial communication error [M8063 and M8438]

These devices turn ON when an error occurs in serial communication.

1. Detailed contents

These devices work as the serial communication error flag.

M8063 turns ON when an error occurs in serial communication using the communication port (ch1).

M8438 turns ON when an error occurs in serial communication using the communication port (ch2).

When M8063 turns ON, a corresponding error code is stored in D8063.

When M8438 turns ON, a corresponding error code is stored in D8438.

2. Cautions on use

The serial communication error flag does not turn OFF even after communication recovers its normal status. Clear it by changing the PLC mode from STOP to RUN.

12.4.2 Sending wait flag [M8401 and M8421]

These devices remain ON while the PLC is waiting to send.

1. Detailed contents

M8401 remains ON while the PLC is waiting to send in communication using the communication port 1 (ch1).

M8421 remains ON while the PLC is waiting to send in communication using the communication port 2 (ch2).

- In full-duplex communication

While the control line is set to the standard or interlink mode in a communication parameter, when the control line DR (DSR) turns OFF while sending data, the PLC waits to send and M8401 or M8421 turns ON.

- In half-duplex communication

When the sending request device is set to ON while data is being received, the PLC waits to send and M8401 or M8421 turns ON.

12.4.3 Sending request [M8402 and M8422]

When these devices are set to ON by SET instruction, the PLC starts to send.

1. Detailed contents

When these devices are set to ON by SET instruction, the PLC starts to send. When sending is completed, these devices are automatically set to OFF.

When the communication port (ch1) is used, M8402 is set.

When the communication port (ch2) is used, M8422 is set.

2. Cautions on use

When setting these devices to ON, set the drive condition in the pulse type.

12.4.4 Receiving complete flag [M8403 and M8423]

These devices turn ON when receiving is completed.

1. Detailed contents

These devices turn ON when receiving is completed.

When the communication port (ch1) is used, M8403 is set.

When the communication port (ch2) is used, M8423 is set.

Receiving is completed in either of the following three conditions.

- When the PLC receives as many receive data as the number specified by the RS2 instruction
- When the terminators are set, and the PLC receives the code set in the terminators
- When data receiving is suspended and the PLC does not receive the next set of data within the time set in the timeout determination time setting device

When the receiving complete flag turns ON, transfer the received data to another storage destination, and then set this flag to OFF.

When this flag is set to OFF, the PLC waits to receive.

2. Cautions on use

When RS2 instruction is driven while the amount of received data is set to "0", the PLC does not start to wait to receive. In such a case, set the amount of received data to "1" or more, set the receiving complete flag to ON, and then set it to OFF.

12.4.5 Carrier detection flag [M8404 and M8424]

These devices turn ON/OFF in synchronization with the CD (DCD) signal.

1. Detailed contents

The CD (DCD) signal (channel receiving carrier detection) turns ON when the modem line is established.

When the communication port (ch1) is used, M8404 turns ON/OFF.

When the communication port (ch2) is used, M8424 turns ON/OFF.

While the carrier detection flag is OFF, the dial number can be sent.

While the carrier detection flag is ON, data can be sent and received.

12.4.6 Data set ready (DSR) flag [M8405 and M8425]

These devices turn ON/OFF in synchronization with the DR (DSR) signal.

1. Detailed contents

The state of DR (DSR) signal can be checked when executing RS2 instruction.

When the communicating port (ch1) is used, M8405^{*1} turns ON/OFF.

When the communication port (ch2) is used, M8425^{*1} turns ON/OFF.

The images of M8405 and M8425 are updated during END processing.

*1. Supported in FX3U and FX3UC PLCs Ver.2.30 and later.

A	Common Items
B	N:N Network
C	Parallel Link
D	Computer Link
E	Inverter Communication
F	Non-Protocol Communication (RS/RS2 Instruction)
G	Non-Protocol Communication (FX2N-232IF)
H	Programming Communication
I	Remote Maintenance

12.4.7 Timeout determination flag [M8409 and M8429]

These devices turn ON when data receiving is suspended, and the next set of receive data is not given within the time set by the timeout determination time setting device.

1. Detailed contents

These devices turn ON when data receiving is suspended and the next set of receive data is not given within the time set by the timeout determination time setting device. The receiving complete flag also turns ON. When communication port (ch1) is used, M8409 turns ON. When communication port (ch2) is used, M8429 turns ON. The timeout determination flag turns OFF when the PLC waits to receive. Using this function, the PLC can receive data from equipment where the amount of send data varies without the terminators.

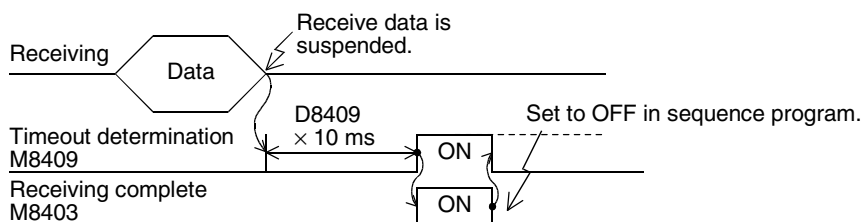

12.4.8 Serial communication error code [D8063 and D8438]

When a serial communication error occurs, these devices store the corresponding error codes.

1. Detailed contents

When a serial communication error occurs, these devices store the corresponding error codes shown below. When communication port (ch1) is used, M8063 turns ON. When communication port (ch2) is used, M8438 turns ON.

Error code		Contents of error
ch1 (D8063)	ch2 (D8438)	
6301	3801	Parity error, overrun error or framing error
6302	3802	Incorrect communication character
6303	3803	Communication data sum mismatch
6304	3804	Incorrect data format
6305	3805	Incorrect command
6306	3806	Monitoring timeout
6307	3807	Modem initialization error
6308	3808	N:N Network parameter error
6312	3812	Parallel link parameter error
6313	3813	Parallel link sum error
6314	3814	Parallel link format error
6320	3820	Error in communication with inverter

2. Cautions on use

The serial communication error code is not cleared even after communication recovers its normal status. Clear it by changing the PLC mode from STOP to RUN.

12.4.9 Communication format setting [D8400 and D8420]

These devices set the communication format.

1. Detailed contents

These devices can set the data length, parity, baud rate, etc.

When communication port (ch1) is used, D8400 sets the communication format.

When communication port (ch2) is used, D8420 sets the communication format.

The table below shows the contents of the communication format settings. Computer link setting is not applicable for D8400.

Bit No.	Name	Contents			
		0 (bit = OFF)	1 (bit = ON)		
b0	Data length	7-bit	8-bit		
b1 b2	Parity	b2, b1 (0, 0): Not provided (0, 1): Odd (1, 1): Even			
b3	Stop bit	1-bit	2-bit		
b4 b5 b6 b7	Baud rate (bps)	b7, b6, b5, b4 (0, 0, 1, 1): 300 (0, 1, 0, 0): 600 (0, 1, 0, 1): 1200 (0, 1, 1, 0): 2400	b7, b6, b5, b4 (0, 1, 1, 1): 4800 (1, 0, 0, 0): 9600 (1, 0, 0, 1): 19200		
b8*1	Header	Not provided	Provided*3		
b9*1	Terminator	Not provided	Provided*3		
b10 b11 b12	Control line	Non-protocol communication	b12, b11, b10 (0, 0, 0): Not provided <RS-232C interface> (0, 0, 1): Standard mode <RS-232C interface> (0, 1, 0): Interlink mode <RS-232C interface> (0, 1, 1): Modem mode <RS-232C interface> (1, 1, 1): Communication in accordance with RS-485 <RS-485/RS-422 interface>		
		Computer link	b12, b11, b10 (0, 0, 0): RS-485/RS-422 interface (0, 1, 0): RS-232C interface		
b13	Sum check	Not added	Added*4		
b14*2	Protocol	Not used	Used		
b15	Control procedure (CR, LF)	Non-protocol communication	CR, LF: Not used (Format 1)	Non-protocol communication	CR, LF: Used (Format 2)
		Computer link	CR, LF: Not used (Format 1)	Computer link	CR, LF: Used (Format 4)

*1. Make sure to set as "0" when using computer link.

*2. Make sure to set as "0" when using non-protocol communication.

*3. In RS2 instruction, up to four headers and up to four terminators can be set.

*4. When executing non-protocol communication using RS2 instruction, add the sum check after the terminators.

Make sure to set the terminators when adding the sum check.

2. Cautions on use

In FX3U and FX3UC PLCs, the communication format can be set using parameters.

A Common Items
 B N:N Network
 C Parallel Link
 D Computer Link
 E Inverter Communication
 F Non-Protocol Communication (RS/RS2 Instruction)
 G Non-Protocol Communication (FX2N-232IF)
 H Programming Communication
 I Remote Maintenance

12.4.10 Amount of remaining send data [D8402 and D8422]

These devices store the amount of remaining send data.

1. Detailed contents

These devices store the amount of remaining send data in 8-bit (1 byte) units.
When communication port (ch1) is used, D8402 stores the value.
When communication port (ch2) is used, D8422 stores the value.
Only data in communication frames are regarded as the targets of counting.

12.4.11 Amount of data already received [D8403 and D8423]

These devices store the amount of data already received.

1. Detailed contents.

These devices stores the amount of data already received in 8-bit (1 byte) units.
When communication port (ch1) is used, D8403 stores the value.
When communication port (ch2) is used, D8423 stores the value.

12.4.12 Communication parameter display [D8405 and D8425]

These devices store the communication parameters set in the PLC.

1. Detailed contents

When the PLC power is turned ON, these devices store the contents of the communication parameters.
The setting contents are the same as those of the communication format setting device.
When communication port (ch1) is used, D8405 stores the contents.
When communication port (ch2) is used, D8425 stores the contents.

12.4.13 Timeout determination time [D8409 and D8429]

These devices set the timeout determination time.

1. Detailed contents

These devices set the error evaluation time (in 10 ms units) used when receiving of data is interrupted.
When communication port (ch1) is used, D8409 sets the time.
When communication port (ch2) is used, D8429 stores the time.
The setting range is from 1 to 255 (10 ms to 2550 ms).

12.4.14 Header [D8410, D8411, D8430 and D8431]

These devices set the headers 1, 2, 3 and 4.

1. Detailed contents

When "header provided" is selected in the communication format setting, the headers are set in the sent and received data.

Up to four headers can be set in each channel.

When communication port (ch1) is used, D8410 and D8411 set the headers.

When communication port (ch2) is used, D8430 and D8431 set the headers.

The headers are set in the following order.

Header	Header 1	Header 2	Header 3	Header 4
ch1	D8410 (lowest-order byte)	D8410 (highest-order byte)	D8411 (lowest-order byte)	D8411 (highest-order byte)
ch2	D8430 (lowest-order byte)	D8430 (highest-order byte)	D8431 (lowest-order byte)	D8431 (highest-order byte)

When data is sent, the data set in the headers is added at the head of the specified send data.

When data is received, receiving begins when the data set in the headers is received.

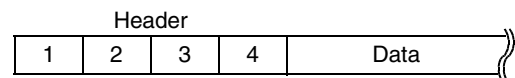

2. Cautions on use

Even if "header provided" is selected, headers are not provided if header 1 is set to "H00".

The area before "H00" (in byte units) is used to set the headers.

12.4.15 Terminator [D8412, D8413, D8432 and D8433]

These devices set the terminators 1, 2, 3 and 4.

1. Detailed contents

When "terminator provided" is selected in the communication format setting, the terminators are set in the sent and received data.

Up to four terminators can be set in each channel.

When communication port (ch1) is used, D8412 and D8413 set the terminators.

When communication port (ch2) is used, D8432 and D8433 set the terminators.

The terminators are set in the following order.

Terminator	Terminator 1	Terminator 2	Terminator 3	Terminator 4
ch1	D8412 (lowest-order byte)	D8412(highest-order byte)	D8413 (lowest-order byte)	D8413 (highest-order byte)
ch2	D8432 (lowest-order byte)	D8432 (highest-order byte)	D8433 (lowest-order byte)	D8433 (highest-order byte)

When data is sent, the data set in the terminators is added at the end of the specified send data.

When data is received, receiving is completed when the data set in the terminators is received.

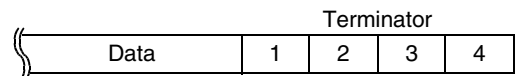

2. Cautions on use

Even if "terminator provided" is selected, terminators are not provided if terminator 1 is set to "H00".

The area before "H00" (in byte units) is used to set the terminators.

12.4.16 Receiving sum (receive data) [D8414 and D8434]

These devices store the received sum check value.

1. Detailed contents

When "sum check provided" is selected in the communication format setting, the sum check is executed for the sent and received data.

These devices store the sum added to the received data sent from the counterpart equipment.

When communication port (ch1) is used, D8414 stores the receiving sum.

When communication port (ch2) is used, D8434 stores the receiving sum.

2. Cautions on use

When selecting "sum check provided", make sure to also select "terminator provided".

12.4.17 Receiving sum (calculation result) [D8415 and D8435]

These devices store the sum check value calculated using the received data.

1. Detailed contents

When "sum check provided" is selected in the communication format settings, the sum check is executed for the sent and received data.

These devices store the sum calculated by the FX PLC from the data received sent from the external equipment.

When communication port (ch1) is used, D8415 stores the receiving sum.

When communication port (ch2) is used, D8435 stores the receiving sum.

2. Cautions on use

When selecting "sum check provided", make sure to also select "terminator provided".

12.4.18 Sending sum [D8416 and D8436]

These devices store the sum check value added to the send data.

1. Detailed contents

When "sum check provided" is selected in the communication format settings, the sum check is executed for the sent and received data.

These devices store the sum calculated from the send data.

When communication port (ch1) is used, D8416 stores the sending sum.

When communication port (ch2) is used, D8436 stores the sending sum.

2. Cautions on use

When selecting "sum check provided", make sure to select "terminator provided".

12.4.19 Operation mode display [D8419 and D8439]

These devices store the communication type being used.

1. Detailed contents

These devices store the code of the communication type currently being used in the communication port.

When communication port (ch1) is used, D8419 stores the communication type.

When communication port (ch2) is used, D8439 stores the communication type.

The table below shows the contents of the communication type codes.

Code	Description
0	Programming communication
2	Protocol dedicated to computer link
3	N:N Network
4	RS instruction
5	RS2 instruction
6	Parallel link
7	Inverter instruction

2. Cautions on use

These devices store "5" while RS2 instruction is being driven or when RS2 instruction is not changed over to another mode.

12.5 ASCII Code Table

<ASCII code table (8-bit code expressed in hexadecimal)>
 The ASCII codes A1H to DFH indicate Japanese characters.

Hexa decimal	0	1	2	3	4	5	6	7	8	9	A	B	C	D	E	F
0		DLE	SP	0	@	P	`	p				-	々	ミ		
1	SOH	DC1	!	1	A	Q	a	q			。	ア	チ	ム		
2	STX	DC2	”	2	B	R	b	r			「	イ	ツ	メ		
3	ETX	DC3	#	3	C	S	c	s			」	ウ	テ	モ		
4	EOT	DC4	\$	4	D	T	d	t			,	エ	ト	ヤ		
5	ENQ	NAK	%	5	E	U	e	u			.	オ	ナ	ユ		
6	ACK	SYN	&	6	F	V	f	v			ヲ	カ	ニ	ヨ		
7	BEL	ETB	'	7	G	W	g	w			ア	キ	ヌ	ラ		
8	BS	CAN	(8	H	X	h	x			イ	ク	ネ	リ		
9	HT	EM)	9	I	Y	i	y			ウ	ケ	ノ	ル		
A	LF	SUB	*	:	J	Z	j	z			エ	コ	ハ	レ		
B	VT	ESC	+	;	K	[k	{			オ	サ	ヒ	ロ		
C	FF	FS	,	<	L	*1	l				ヤ	シ	フ	ワ		
D	CR	GS	-	=	M]	m	}			ユ	ス	ハ	ン		
E	SO	RS	.	>	N	^	n	~			ヨ	セ	ホ	ン		
F	SI	US	/	?	O	_	o	DEL			ツ	リ	マ	。		

*1. \ (ASCII CODE:5C) symbol is displayed as "¥" in Japanese.

MEMO

FX Series Programmable Controllers

User's Manual

[Non-Protocol Communication (FX2N-232IF)]

Foreword

This manual explains "non protocol communication" provided in MELSEC-F FX Series Programmable Controllers using the FX2N-232IF and should be read and understood before attempting to install or use the unit.

Also, store this manual in a safe place so that you can take it out and read it whenever necessary. Always forward it to the end user.

This manual confers no industrial property rights or any rights of any other kind, nor does it confer any patent licenses. Mitsubishi Electric Corporation cannot be held responsible for any problems involving industrial property rights which may occur as a result of using the contents noted in this manual.

© 2005 MITSUBISHI ELECTRIC CORPORATION

A
Common Items

B
N:N Network

C
Parallel Link

D
Computer Link

E
Inverter Communication

F
Non-Protocol Communication (RS/RS2 Instruction)

G
Non-Protocol Communication (FX2N-232IF)

H
Programming Communication

I
Remote Maintenance

1. Outline

The communication special function block operating in accordance with RS-232C FX2N-232IF (hereafter referred to as "232IF") is connected to an FX2N, FX3U, FX2NC, or FX3UC PLC to transfer serial data in the full-duplex method between equipment having RS-232C interface such as personal computer, bar code reader and printer.

For the contents of the hardware, refer to the "FX2N-232IF Hardware Manual".

1.1 Features

1. Two or more 232IF (equipment operating in accordance with RS-232C) can be connected.

Two or more pieces of external equipment having RS-232C interface can be connected to an FX PLC.

- 1) For FX2N and FX3U PLCs
Up to eight pieces of external equipment can be connected to one PLC.
- 2) For FX2NC PLCs
Up to four pieces of external equipment can be connected to one PLC.
- 3) For FX3UC PLCs
Up to seven pieces of external equipment can be connected to one PLC.

2. Non-protocol communication

Communication is executed in the full-duplex, asynchronous system, non-protocol method. The communication format can be specified using the buffer memory (BFM).

The FROM and TO instructions are applicable for the buffer memory.

(In FX3U and FX3UC PLCs, other instructions are also applicable.)

3. Send/receive data buffer of 512 bytes/256 words

The send data buffer and receive data buffer can store 512 bytes/256 words respectively.

In the RS-232C interlink connection mode, the 232IF can receive data beyond 512 bytes/256 words.

4. Built-in ASCII-Hexadecimal conversion function

By using this built-in conversion function, hexadecimal numeric values (0 to F) inside the send data buffer can be converted into ASCII codes when being sent, and received ASCII codes can be converted into hexadecimal values (0 to F) when being stored in the received data buffer.

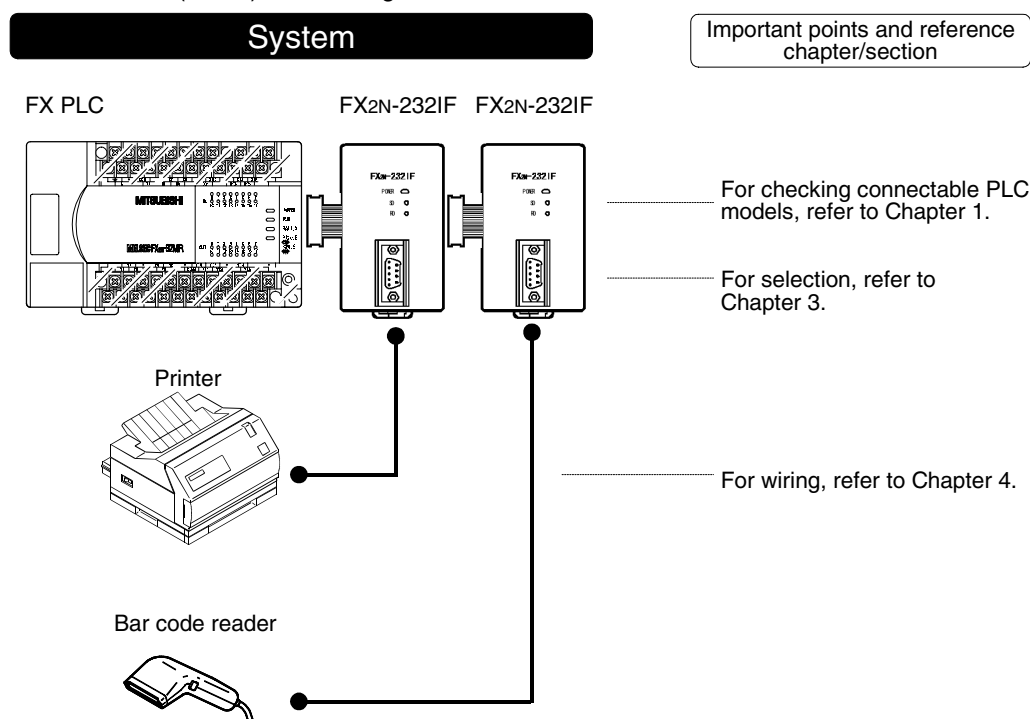

A	Common Items
B	N:N Network
C	Parallel Link
D	Computer Link
E	Inverter Communication
F	Non-Protocol Communication (RS/RS2 Instruction)
G	Non-Protocol Communication (FX2N-232IF)
H	Programming Communication
I	Remote Maintenance

1.2 Major Procedures until Operation

The flow chart below shows the procedures for setting non-protocol communication (operating in accordance with 232IF) until data transfer:

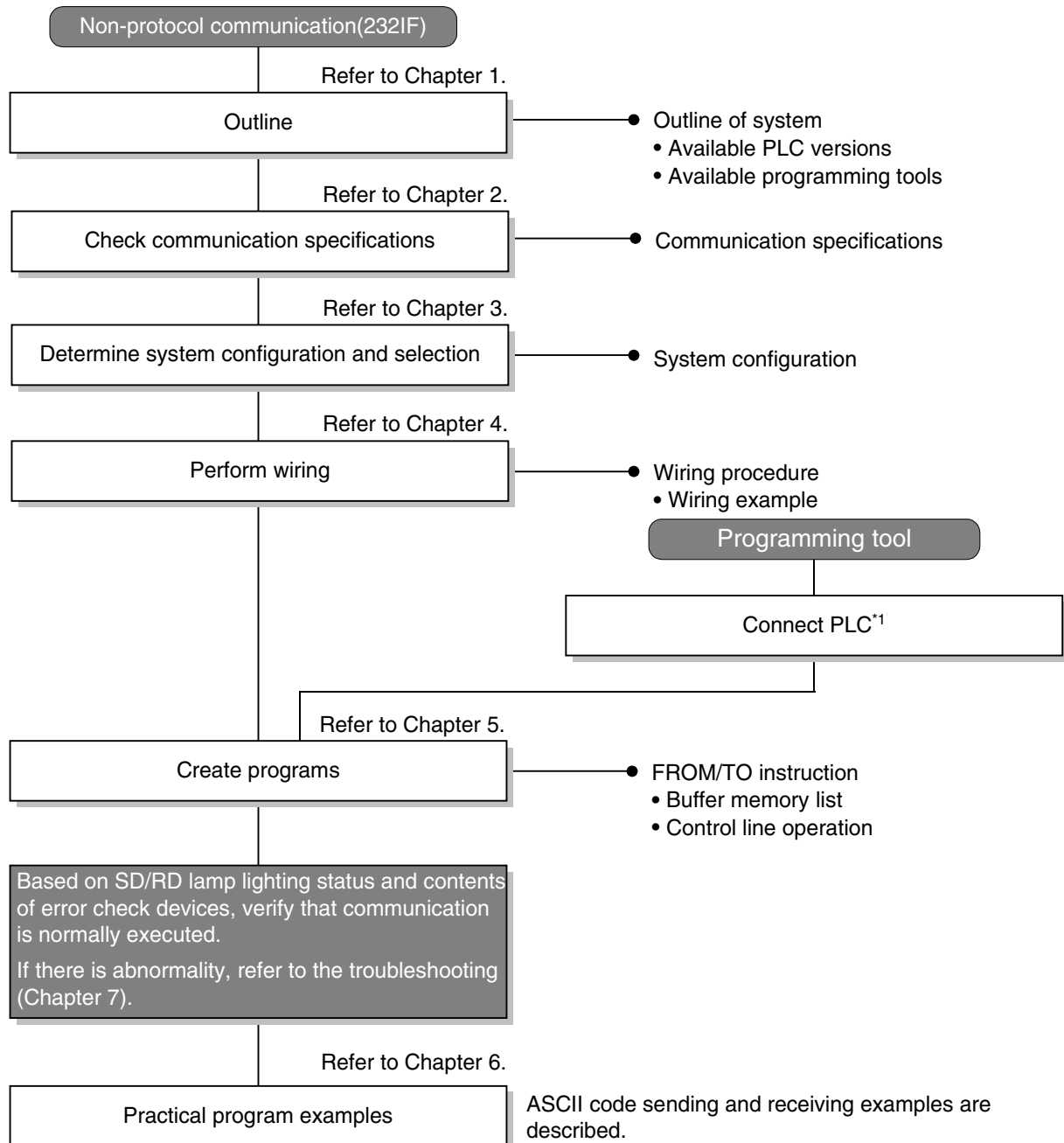

*1 For the method to connect a programming tool to a PLC, refer to the section "Programming Communication" in this manual or the manual of each programming tool.
 For details on operating procedures, refer to the manual of each programming tool.

1.3 Communication Type Applicability in PLC

1.3.1 Applicable versions

The communication types are applicable in the following versions.

✓: Applicable (If applicable versions are limited, they are described inside ().)
 —: Not applicable

PLC	Applicability (applicable version)	Remarks
FX3UC Series	✓	
FX3U Series	✓	
FX2NC Series	✓	
FX2N Series	✓	
FX1NC Series	—	232IF is not connectable.
FX1N Series	—	232IF is not connectable.
FX1S Series	—	232IF is not connectable.
FX0N Series	—	232IF is not connectable.
FX0s Series	—	232IF is not connectable.
FX0 Series	—	232IF is not connectable.
FX2c Series	—	232IF is not connectable.
FX2(FX) Series	—	232IF is not connectable.
FX1 Series	—	232IF is not connectable.

1.3.2 Products whose production was stopped

The table below shows series in which production of the main unit, communication equipment, etc. is stopped.

Use the description on system configuration, etc. in this manual for maintenance.

PLC	Date when production was stopped	Remarks
FX0 Series	June 30, 2002	Maintenance is offered within 7 years from the end of production (until June 30, 2009).
FX2c Series		
FX2(FX) Series		
FX1 Series		

A	Common Items
B	N:N Network
C	Parallel Link
D	Computer Link
E	Inverter Communication
F	Non-Protocol Communication (RS/RS2 Instruction)
G	Non-Protocol Communication (FX2N-232IF)
H	Programming Communication
I	Remote Maintenance

1.4 Programming Tool Applicability

1.4.1 For applicable versions

The programming tool is applicable in each FX Series from the following version:

1. Japanese versions

✓: Applicable (If applicable versions are limited, they are described inside ().)
 —: Not applicable

Model name (Media model name is shown below.)	Applicability (applicable version)	Remarks
FX3U and FX3UC PLCs		
GX Developer SW□D5C(F)-GPPW-J	✓ (Ver. SW8 P or later) Ver. 8.13P	Select the model "FX3UC"
FX2N and FX2NC PLCs		
GX Developer SW□D5C(F)-GPPW-J	✓ (Ver. SW2 A or later)	Select the model "FX2N/FX2NC"
FX-PCS/WIN SW0PC-FXGP/WIN	✓ (Ver. 2.00 or later)	
FX-PCS-KIT/98 SW1PC-FXGP/98(-3,-5)	✓ (Ver. 4.00 or later)	
FX-PCS/98-3 SW1PC-FXGP/98-3	✓ (Ver. 4.00 or later)	
FX-PCS-KIT/V-3 SW1-PC-FXGP/V3	✓ (Ver. 2.00 or later)	
FX-A7PHP-KIT SW1RX-GPPFX	✓ (Ver. 3.00 or later)	
FX-20P(-SET0) FX-20P-MFXC	✓ (Ver. 4.00 or later)	
FX-10P(-SET0)	✓ (Ver. 3.00 or later)	
GOT-F900 Series display units F940WGOT-TWD F940GOT-*WD F940GOT-*BD-H F940GOT-*BD-RH	✓ (Refer to right column)	F940WGOT-TWD (Ver. 1.00 or later) F940GOT-LWD, F940GOT-SWD (Ver. 1.00 or later) F940GOT-LBD-H, F940GOT-SBD-H (Ver. 1.00 or later) F940GOT-LBD-RH, F940GOT-SBD-RH (Ver. 1.00 or later)

2. English versions

✓: Applicable (If applicable versions are limited, they are described inside ().)
 —: Not applicable

Model name (Media model name is shown below.)	Applicability (applicable version)	Remarks
FX3u and FX3UC PLCs		
GX Developer SW□D5C(F)-GPPW-E	✓ (Ver. SW8 P or later) Ver. 8.13P	Select the model "FX3UC"
FX2N and FX2NC PLCs		
GX Developer SW□D5C(F)-GPPW-E	✓ (Ver. SW2 A or later)	Select the model "FX2N/FX2NC"
FX-PCS/WIN-E SW0PC-FXGP/WIN-E	✓ (Ver. 1.00 or later)	
FX-20P-E(-SET0) FX-20P-MFXC-E	✓ (Ver. 3.00 or later)	
FX-10P-E	✓ (Ver. 3.00 or later)	
GOT-F900 Series display units F940WGOT-TWD-E F940GOT-*WD-E F940GOT-*BD-H-E F940GOT-*BD-RH-E	✓ (Refer to right column)	F940WGOT-TWD-E (Ver. 1.00 or later) F940GOT-LWD-E, F940GOT-SWD-E (Ver. 1.00 or later) F940GOT-LBD-H-E, F940GOT-SBD-H-E (Ver. 1.00 or later) F940GOT-LBD-RH-E, F940GOT-SBD-RH-E (Ver. 1.00 or later)

1.4.2 For non-applicable versions (setting an alternative model)

Even software not applicable to a PLC can make programs when an alternative model is set. In this case, however, programming is enabled only in the function ranges such as instructions and program size provided in a PLC selected as the alternative model.

Model to be programmed	Model to be set	Priority: High → Low			
		→		→	
FX3UC Series	FX3UC	→	FX2N	→	FX2(FX)
FX3U Series	FX3U, FX3UC	→	FX2N	→	FX2(FX)
FX2NC Series	FX2NC, FX2N	→	FX2(FX)		
FX2N Series	FX2N	→	FX2(FX)		

A	Common Items
B	N:N Network
C	Parallel Link
D	Computer Link
E	Inverter Communication
F	Non-Protocol Communication (RS/RS2 Instruction)
G	Non-Protocol Communication (FX2N-2321F)
H	Programming Communication
I	Remote Maintenance

2. Specification

This chapter explains the communication specifications.

2.1 Communication Specifications

Non-protocol communication type is used in the communication specifications shown in the table below.

Item	Specifications	Remarks
Transmission standard	RS-232C standard	
Maximum total extension distance	15 m (49' 2")	
Protocol type	Non-protocol communication	
Communication method	Full-duplex, asynchronous system	
Baud rate	300/600/1200/2400/4800/9600/19200 bps	
Character format	—	
Start bit	—	
Data bit	7-bit/8-bit	
Parity bit	None, odd or even	
Stop bit	1-bit/2-bit	
Header	Provided or not provided	Up to four bytes can be specified.
Terminator	Provided or not provided	
Control line	Provided or not provided	
Sum check	Provided or not provided	

3. System Configuration and Selection

This chapter explains the system configuration and selection of the FX PLC and 232IF.

3.1 System Configuration

This section explains the outline of the system configuration required to use the 232IF.

1 and **2** indicate the pattern types of combination of communication equipment.

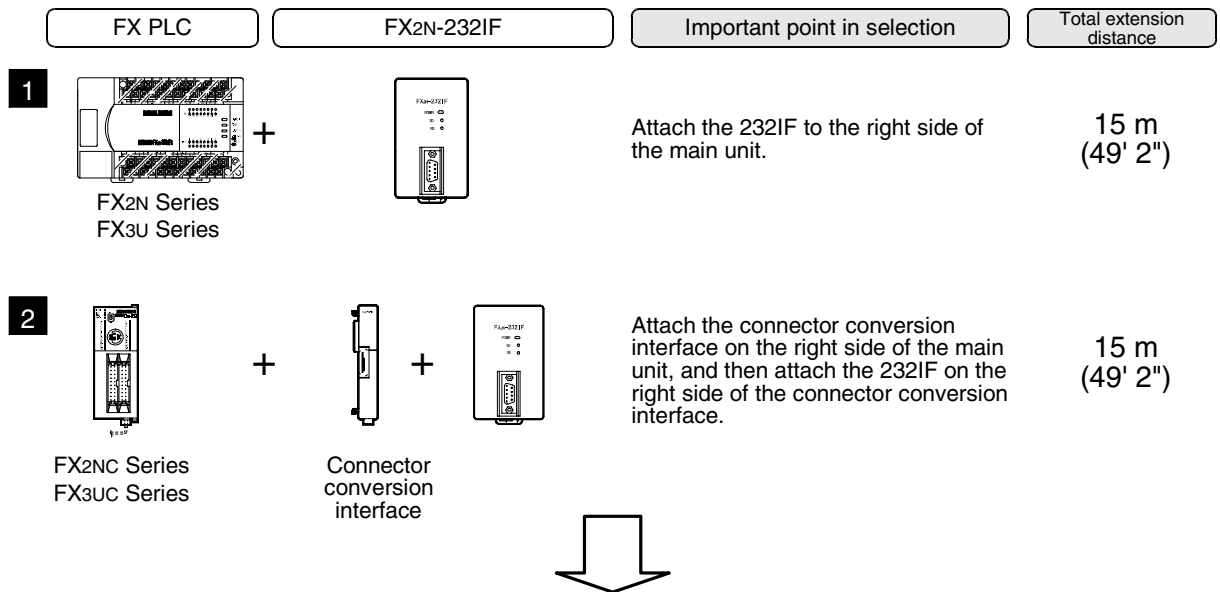



For combinations of communication equipment for each FX Series, refer to the next section.



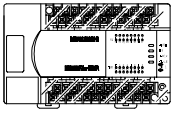
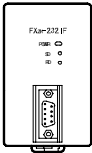
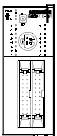

3.2 Applicable FX PLC and Communication Equipment

Select a combination of 232IF, and put a check mark in the "Check" column.
 In selection, pay attention to the following:

- The capacity of the 5V DC power supplied from the PLC is limited. The current consumption at 5V DC of the 232IF is 40 mA. Make sure that total current consumption at 5V DC including other blocks does not exceed the specified value.

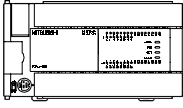
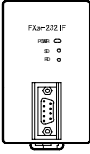
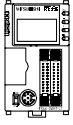
FX Series	Communication equipment (option)	Total extension distance	Check
 FX2N	 FX2N-232IF (9-pin D-Sub, male)	15 m (49' 2")	
 FX2NC	 +  FX2NC-CNV-IF FX2N-232IF (9-pin D-Sub, male)	15 m (49' 2")	

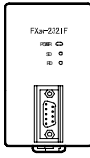
A	Common Items
B	N:N Network
C	Parallel Link
D	Computer Link
E	Inverter Communication
F	Non-Protocol Communication (RS/RS2 Instruction)
G	Non-Protocol Communication (FX2N-232IF)
H	Programming Communication
I	Remote Maintenance

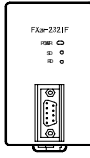
FX Series	Communication equipment (option)	Total extension distance	Check
 FX3U	 FX2N-232IF (9-pin D-Sub, male)	15 m (49' 2")	
 FX3UC	 +  FX2NC-CNV-IF FX2N-232IF (9-pin D-Sub, male)	15 m (49' 2")	
	 +  FX3UC-1PS-5V FX2N-232IF (9-pin D-Sub, male)	15 m (49' 2")	

3.3 Connection to PLC

The 232IF can be directly connected to an FX PLC main unit or to the right side of another function block or powered extension unit.

The unit number is assigned to each special unit/block in the way "No. 0, No. 1, No. 2 ..." from the unit/block nearest to the main unit. (for FX3UC PLC, the unit number is assigned in the way "No. 1, No. 2, No. 3 ...".)

Up to eight 232IF units can be connected to an FX2N/FX3U PLC, up to four 232IF units can be connected to an FX2NC PLC, and up to seven 232IF units can be connected to an FX3UC PLC.

1. For FX2N PLC

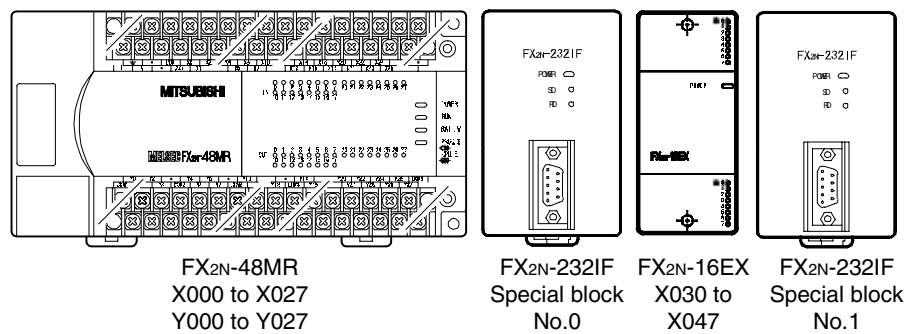

2. For FX3U PLC

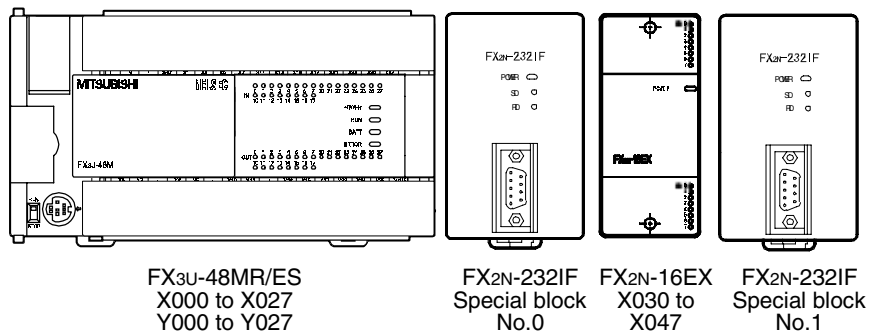

3. For FX2NC PLC

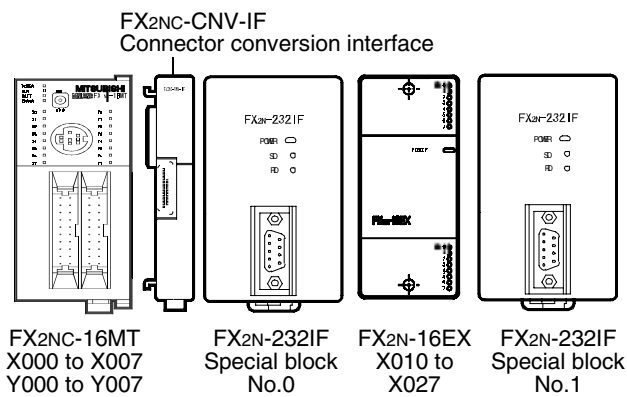

4. For FX3UC PLC

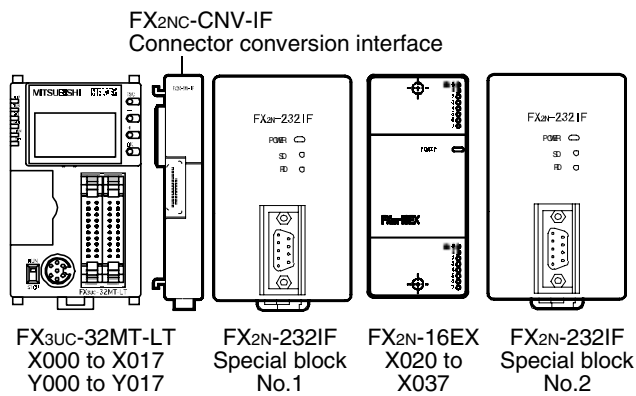

A	Common Items
B	N:N Network
C	Parallel Link
D	Computer Link
E	Inverter Communication
F	Non-Protocol Communication (RS/RS2 Instruction)
G	Non-Protocol Communication (FX2N-232IF)
H	Programming Communication
I	Remote Maintenance

4. Wiring

This chapter explains wiring.

4.1 Pin Arrangement

The table below shows the pin arrangement of the 232IF.
 Example of applicable connector: 17JE-13090-02 (D8C2) by DDK Ltd.

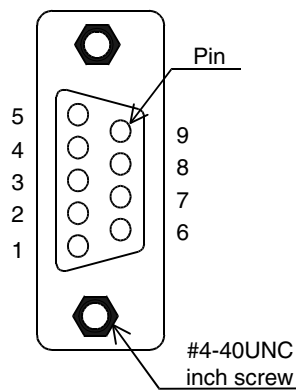

Pin No.	Signal name	Function	Signal direction 232IF: Counterpart equipment
1	CD(DCD)	Carrier detection	←
2	RD(RXD)	Receive data (with LED indicator)	←
3	SD(TXD)	Send data (with LED indicator)	→
4	ER(DTR)	Data terminal ready	→
5	SG(GND)	Signal ground	—
6	DR(DSR)	Data set ready	←
7	RS(RTS)	Sending request (receiving enable)*1	→
8	CS(CTS)	Sending enable	←
9	CI(RI)	Calling indicator	←

*1. The signal inside () is adopted in the interlink connection mode.

4.2 Connection to Counterpart Equipment Having Terminal Specifications (without Control Line)

BFM # 0 (communication format): b9 = 0, b8 = 0 (control line not provided)

PLC side		RS-232C external equipment side		
Name	FX2N-232IF	Name	9-pin D-Sub	25-pin D-Sub
SD(TXD)	3	SD(TXD)	3	2
RD(RXD)	2	RD(RXD)	2	3
SG(GND)	5	SG(GND)	5	7

4.3 Connection to Counterpart Equipment Having Terminal Specifications (with Control Line)

4.3.1 Standard RS-232C mode

Cross cable, BFM #0 (communication format): b9 = 0, b8 = 1 (standard RS-232C mode)

PLC side		RS-232C external equipment side		
Name	FX2N-232IF	Name	9-pin D-Sub	25-pin D-Sub
SD(TXD)	3	SD(TXD)	3	2
RD(RXD)	2	RD(RXD)	2	3
RS(RTS)	7	RS(RTS)	7	4
CS(CTS)	8	CS(CTS)	8	5
CD(DCD)	1	CD(DCD)	1	8
ER(DTR)	4	ER(DTR)	4	20
DR(DSR)	6	DR(DSR)	6	6
SG(GND)	5	SG(GND)	5	7

When the FX2N-232IF receives RS (request to send) signal at its carrier to send (CS) pin, the FX2N-232IF transfers signals as if the counterpart equipment exists.

- *1. It is not necessary to connect the CD signal if monitoring the CD signal is not required. For the CD signal, the 232IF indicates only the status.
- *2. The 232IF indicates only the status.

4.3.2 Interlink connection mode

Interlink serial cross cable, BFM #0 (communication format): b9 = 1, b8 = 1 (RS-232C interlink connection mode)

PLC side		RS-232C external equipment side		
Name	FX2N-232IF	Name	9-pin D-Sub	25-pin D-Sub
SD(TXD)	3	SD(TXD)	3	2
RD(RXD)	2	RD(RXD)	2	3
RS(RTS)	7	RS(RTS)	7	4
CS(CTS)	8	CS(CTS)	8	5
ER(DTR)	4	ER(DTR)	4	20
DR(DSR)	6	DR(DSR)	6	6
SG(GND)	5	SG(GND)	5	7

In the interlink connection mode, the 232IF can receive data larger than 512 bytes which is the upper limit of the received data buffer in the 232IF.

- *1. In this mode, request to send (RS) signal works as the receiving enable signal for the 232IF. When the 232IF receives data beyond the maximum number of receivable bytes, it turns OFF which works as the receive ready signal (RS signal) to ask the counterpart equipment to stop sending. At this time, by withdrawing the data located in the received data buffer using a sequence program, the 232IF can receive remaining data.

4.4 Connection to Counterpart Equipment Having Modem Specifications

Straight cable, BFM #0 (communication format): b9 = 0, b8 = 1 (standard RS-232C mode)

PLC side		RS-232C external equipment side		
Name	FX2N-232IF	Name	9-pin D-Sub	25-pin D-Sub
SD(TXD)	3	SD(TXD)	3	2
RD(RXD)	2	RD(RXD)	2	3
RS(RTS)	7	RS(RTS)	7	4
CS(CTS)	8	CS(CTS)	8	5
CD(DCD)	1	CD(DCD)	1	8
ER(DTR)	4	ER(DTR)	4	20
DR(DSR)	6	DR(DSR)	6	6
SG(GND)	5	SG(GND)	5	7
CI(RI)	9	CI(RI)	9	22

- *1. It is not necessary to connect the CD signal if monitoring the CD signal is not required. For the CD signal, the 232IF indicates only the status.
- *2. The 232IF indicates only the status.
- *3. It is not necessary to connect the CI signal if monitoring of the CI signal is not required. For the CI signal, the 232IF indicates only the status.

5. Creating Programs

This chapter explains how to create programs for non-protocol communication type using the 232IF.

5.1 Outline of Communication between FX PLC and 232IF

An FX PLC and 232IF transfer data each other through the buffer memory (BFM).

5.1.1 For FROM and TO instructions

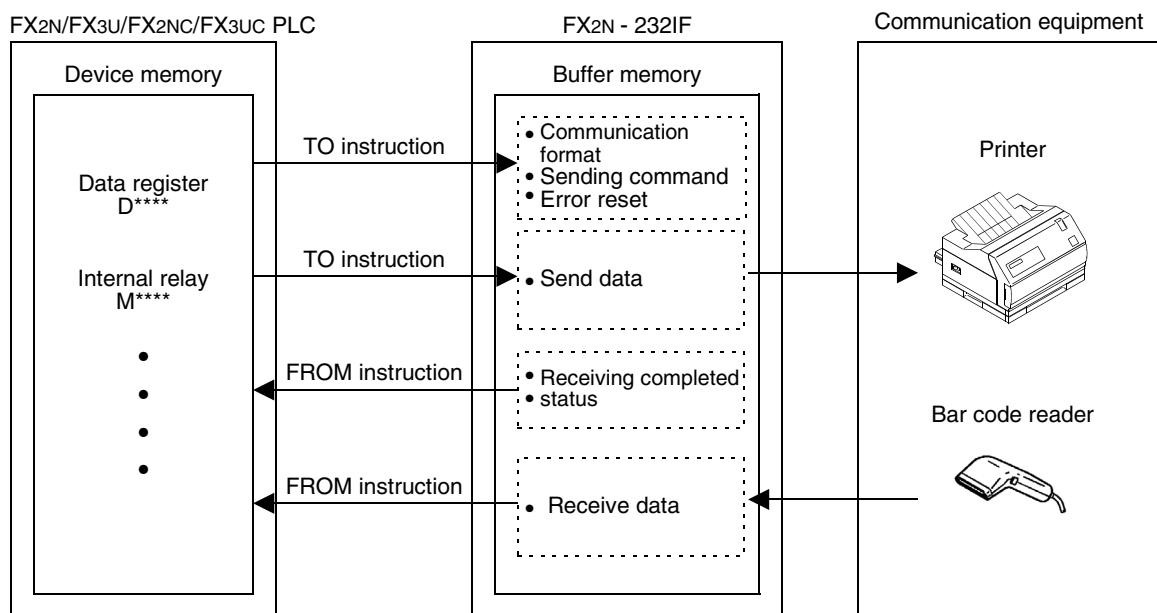

5.1.2 For direct specification of buffer memory (U□\G□)

FX3U and FX3UC PLCs allow not only FROM and TO instructions but also direct specification of the buffer memory (U□\G□) using MOV instruction, etc.

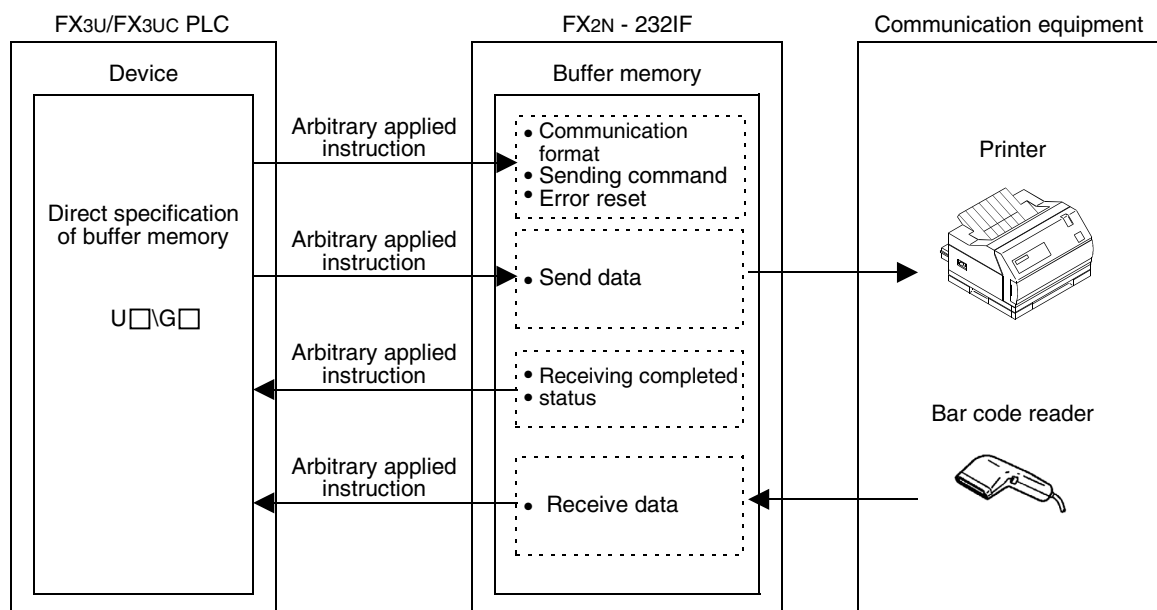

5.2 FROM and TO Instructions

This section explains how to use FROM and TO instructions.

5.2.1 FROM instruction

FROM instruction reads data of the buffer memory in a special block.

1. Applicable devices

- For FX2N/FX2NC PLCs

Operand Type	Bit Devices						Word Devices										Others		
	System User						Digit Specification				System User			Index			Constant		Pointer
	X	Y	M	T	C	S	KnX	KnY	KnM	KnS	T	C	D	V	Z	Modify	K	H	P
m1																✓	✓	✓	
m2																✓	✓	✓	
(D•)								✓	✓	✓	✓	✓	✓	✓	✓	✓			
n																✓	✓	✓	

- For FX3U/FX3UC PLCs

Operand Type	Bit Devices								Word Devices								Others							
	System User								Digit Specification				System User				Special Unit	Index			Constant	Real Number	Character String	Pointer
	X	Y	M	T	C	S	D□.b	KnX	KnY	KnM	KnS	T	C	D	R	U□\G□	V	Z	Modify	K	H	E	"□"	P
m1													✓	✓					✓	✓				
m2													✓	✓					✓	✓				
(D•)								✓	✓	✓	✓	✓	✓	✓		✓	✓	✓						
n													✓	✓					✓	✓				

2. Function and operation

- 16-bit operation (FROM and FROMP)

Special function block (BFM) → PLC (word device)

"n" 16-bit data starting from the buffer memory (BFM) No. m2 inside a special function block No. m1 are transferred (read) to "n" devices starting from (D•) inside a PLC.

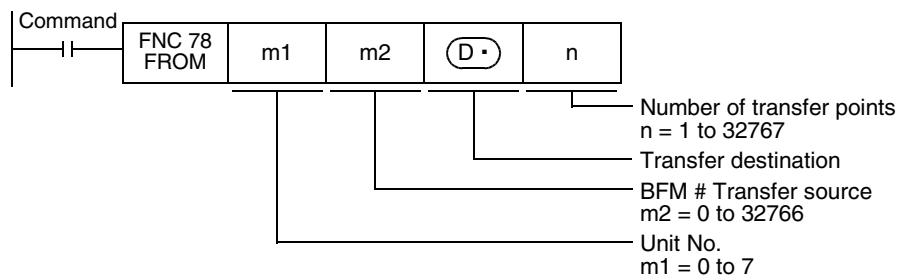

- 32-bit operation (DFROM and DFROMP)

Special function block (BFM) → PLC (word device)

"n" 32-bit data starting from the buffer memory (BFM) No. m2 inside a special function block No. m1 are transferred (read) to "n" devices starting from [(D•)+1, (D•)] inside a PLC.

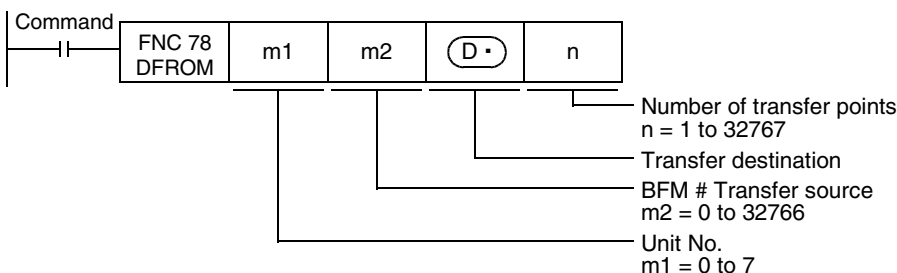

5.2.2 TO instruction

TO instruction writes data to the buffer memory in a special block.

1. Applicable devices

- For FX2N/FX2NC PLCs

Operand Type	Bit Devices						Word Devices										Others		
	System User						Digit Specification				System User			Index			Constant		Pointer
	X	Y	M	T	C	S	KnX	KnY	KnM	KnS	T	C	D	V	Z	Modify	K	H	P
m1																	✓	✓	
m2																	✓	✓	
(S•)							✓	✓	✓	✓	✓	✓	✓	✓	✓	✓	✓	✓	
n																	✓	✓	

- For FX3U/FX3UC PLCs

Operand Type	Bit Devices								Word Devices										Others					
	System User								Digit Specification				System User				Special Unit	Index		Constant	Real Number	Character String	Pointer	
	X	Y	M	T	C	S	D□.b	KnX	KnY	KnM	KnS	T	C	D	R	U□\G□	V	Z	Modify	K	H	E	"□"	P
m1													✓	✓					✓	✓				
m2													✓	✓					✓	✓				
(S•)							✓	✓	✓	✓	✓	✓	✓	✓		✓	✓	✓	✓	✓				
n													✓	✓					✓	✓				

2. Function and operation

- 16-bit operation (TO and TOP)

PLC (word device) → Special function block (BFM)

"n" 16-bit data starting from (S•) inside a PLC are transferred (written) to "n" buffer memories starting from the buffer memory No. m2 inside a special function block No. m1.

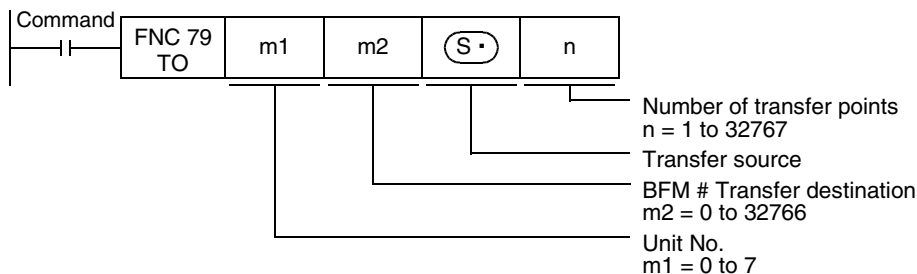

- 32-bit operation (DTO and DTOPT)

PLC (word device) → Special function block (BFM)

"n" 32-bit data starting from [(S•)+1, (S•)] inside a PLC are transferred (written) to "n" buffer memories starting from the buffer memory No. m2 inside a special function block No. m1.

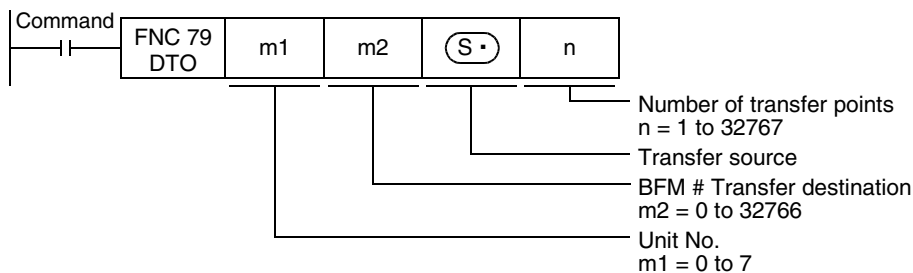

5.3 Direct Specification of Buffer Memory (U□\G□)

In FX3U and FX3UC PLCs, it is enabled to directly specify buffer memories and read/write data from/to the specified buffer memories even with instructions other than the FROM and TO.

1. How to specify a buffer memory directly

When directly specifying a buffer memory, put the following setting directly into the source or destination.

U□\G□

Specifies the block number _____ Specifies the buffer memory number

Example 1: When reading data from the buffer memory No. 4 in the special function block No. 1, and transferring it to D0

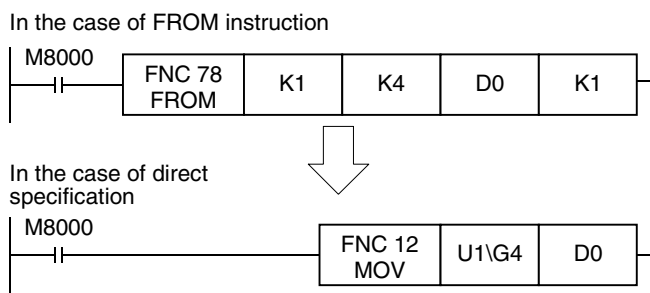

Example 2: When writing the numeric value K1 to the buffer memory No. 1000 in the special function block No. 1 (pulse operation type)

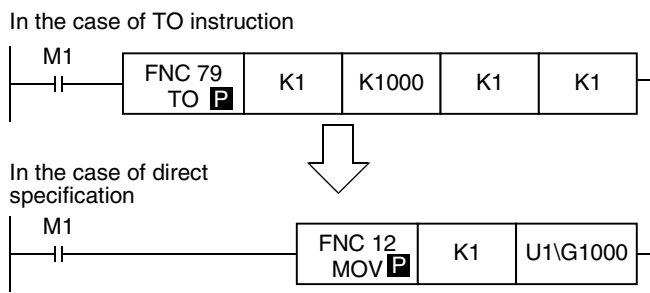

Example 3: When multiplying the value stored in the buffer memory No. 1000 in the special function block No. 1 by the numeric value "K2", and writing the multiplication result to the buffer memories Nos. 2000 and 2001 in the special function block No. 2

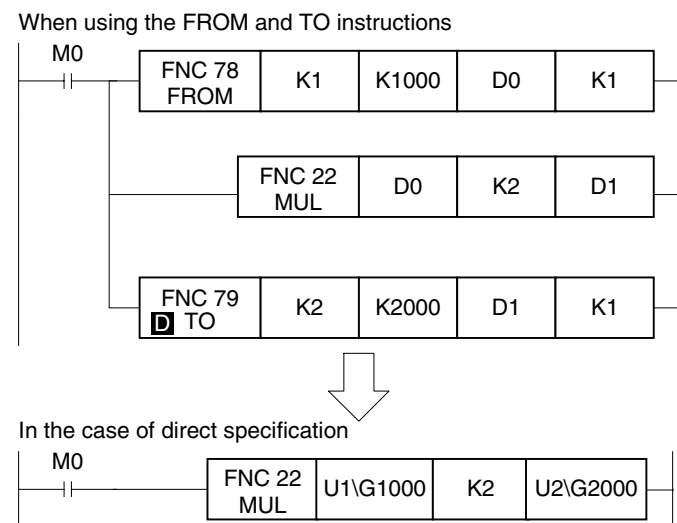

Caution

The FX3UC PLC main unit has the built-in CC-Link/LT master. When extending special function blocks, set the block No. from "1".

A	Common Items
B	N:N Network
C	Parallel Link
D	Computer Link
E	Inverter Communication
F	Non-Protocol Communication (RS/RS2 Instruction)
G	Non-Protocol Communication (FX2N-2321F)
H	Programming Communication
I	Remote Maintenance

5.4 Buffer Memory (BFM)

This section explains the contents of the buffer memory (BFM).

5.4.1 Buffer memory list

BFM No.	Name	Setting range	Initial value	R: For read W: For write
#0	Communication format		0087H	W
#1	Command		0	W
#2	Maximum number of receivable bytes	1 to 512 (when data length is 16-bit) 1 to 256 (when data length is 8-bit) "0" is handled as "512" or "256"	0	W
#3	Receiving timeout time	1 to 32767 (× 10 ms) "0" is handled as "no timeout time".	0	W
#4	Sending header (lowest-order 2 bytes)	4 bytes maximum,	0 (no header)	W
#5	Sending header (highest-order 2 bytes)	0 suppression	0	
#6	Sending terminator (lowest-order 2 bytes)	4 bytes maximum,	0 (no terminator)	W
#7	Sending terminator (highest-order 2 bytes)	0 suppression	0	
#8	Receiving header (lowest-order 2 bytes)	4 bytes maximum,	0 (no header)	W
#9	Receiving header (highest-order 2 bytes)	0 suppression	0	
#10	Receiving terminator (lowest-order 2 bytes)	4 bytes maximum,	0 (no terminator)	W
#11	Receiving terminator (highest-order 2 bytes)	0 suppression	0	
#12	Receiving suspension waiting time (in interlink connection mode)	0 to 32767(× 10 ms)	0	W
#13	Amount of remaining send data	0 to 512 (when data length is 16-bit) 0 to 256 (when data length is 8-bit)	0	R
#14	Amount of received data buffers	0 to 256+15 ^{*1}	0	R
#15	Sending sum result		0	R
#16	Receiving sum result		0	R
#20	Time from CS ON to sending start	0 to 32,767(× 10 ms)	0	W
#21	Time from actual sending completion to RS OFF (complete flag ON)	0 to 32,767(× 10 ms)	0	W
#28	Status		0	R
#29	Error code		0	R
#30	Model code		K7030	R
#1000	Number of bytes to be sent	0 to 512 (when data length is 16-bit) 0 to 256 (when data length is 8-bit)	0	W
#1001 to #1256	Send data buffer		0	W
#2000	Number of received bytes	0 to 512+30 ^{*1} (when data length is 16-bit) 0 to 256+15 ^{*1} (when data length is 8-bit)	0	R
#2001 to #2256	Receive data buffer		0	R

BFM No.	Name	Setting range	Initial value	R: For read W: For write
#2257 to #2271	Preliminary receive data buffer for interlink connection mode		0	R

Caution

Buffer memories specified as "W: For write" can be read also.
 Do not use undefined buffer memory numbers in programs.

- *1. Provided for preliminary buffers for the interlink connection mode.

A	Common Items
B	N:N Network
C	Parallel Link
D	Computer Link
E	Inverter Communication
F	Non-Protocol Communication (RS/RS2 Instruction)
G	Non-Protocol Communication (FX2N-2321F)
H	Programming Communication
I	Remote Maintenance

5.4.2 Communication format <BFM #0>

Bit	Contents	0	1	Initial value
b0	Data length	7-bit	8-bit	1 : 8-bit
b1 b2	Parity	(00) : Not provided (01) : Odd (11) : Even		(11) : Even
b3	Stop bit	1-bit	2-bit	0 : 1-bit
b4 b5 b6 b7	Baud rate (bps)	(0011) : 300 (0100) : 600 (0101) : 1200 (0110) : 2400 (0111) : 4800 (1000) : 9600 (1001) : 19200		(1000) : 9600 bps
b8 b9	Control line	(00) : Not provided (01) : Standard RS-232C (11) : RS-232C interlink mode		(00) : Not provided
b10 b11	CR and LF addition	(00) : Both CR and LF are not added. (01) : Only CR is added. (11) : Both CR and LF are added.		(00) : Not provided
b12 b13	Absence/presence of check sum and ASCII-Hexadecimal conversion	(00) : Both check sum and ASCII-hexadecimal conversion are not provided. (01) : Only ASCII-hexadecimal conversion is provided. (10) : Only check sum is provided. (11) : Both check sum and ASCII-hexadecimal conversion are provided.		(00) : Not provided
b14	Send/receive data buffer data length	16-bit	8-bit	0 : 16-bit
b15	Undefined (cannot be used)	—		0 : Undefined

The communication format setting contents are determined when the sending/receiving enable command (BFM #1, b0) turns ON.

Accordingly, it is necessary to transfer the communication format setting in advance using TO instruction before setting to ON the sending/receiving enable command.

However, the sending header and sending terminator are determined when the sending command (BFM #1, b1) turns ON. And the receiving header and receiving terminator are determined when the sending/receiving enable command (BFM #1, b0) turns ON and the receiving complete flag reset command (BFM #1, b2) turns ON. Accordingly, if only the header and terminator are changed in the middle of communication, such change will become valid at the next sending/receiving operation, (so it is not necessary to turn OFF the sending/receiving enable command).

Example of communication format setting (specified in hexadecimal constant)

When specifying the communication format as shown in the table below, make the following program.

Data length	8-bit
Parity	Odd
Stop bit	1-bit
Baud rate	2400 bps
Control line	Not provided
CR and LF	Not added
Check sum	Not provided
ASCII-hexadecimal conversion	Not provided
Buffer data length	8-bit

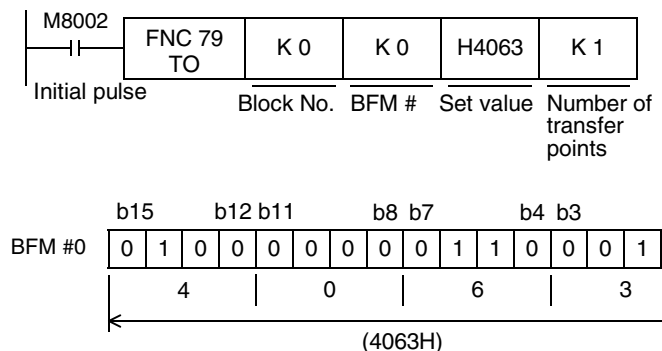

1. Communication format

Select the communication format used to send and receive data in the 232IF among the formats shown on the right.

- 1) The header can be specified before the data in the communication format.
- 2) In the communication format [1], hexadecimal (binary) values and ASCII codes can be sent and received.
 When using the communication formats [2] to [9], make sure to use ASCII codes as the sent and received data.
 The received data should not include the header, terminator and CR. (In the communication formats [4], [7] and [9], the data area after "CR" is not received.)
 By specifying b13 and b12 of the BFM #0, the ASCII-Hexadecimal conversion function can be used in communication.

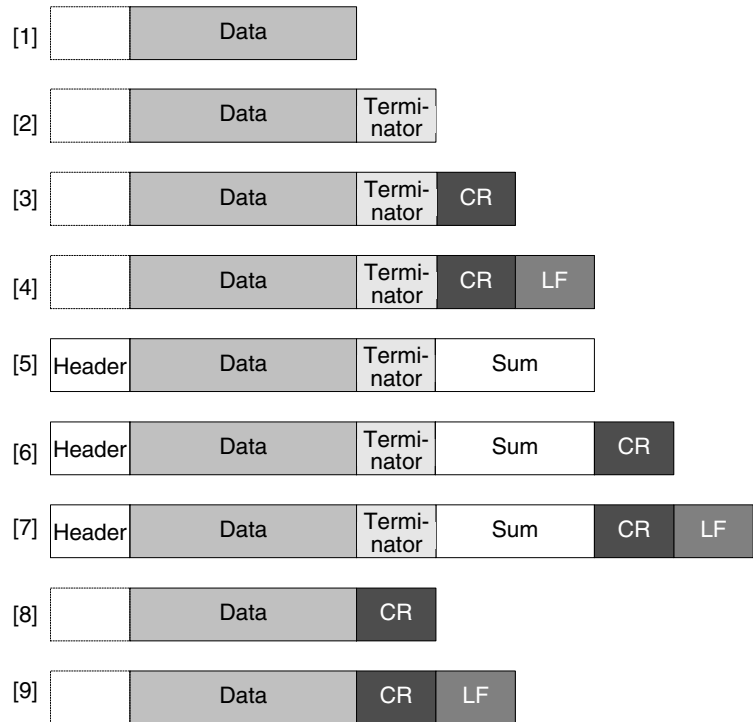

- 3) ASCII codes "01H" to "1FH" can be used as the head terminator.
- 4) In the RS-232C interlink connection mode, the communication formats [2] to [7] are valid.

2. b0 to b7 (data length, parity, stop bit and baud rate)

Align the setting of b0 to b7 with the communication specifications in the connected counterpart equipment.

3. b9 and b8 (control line)

- 1) When "control line not provided (b9 = 0, b8 = 0)" is specified, data is transferred using only the SD and RD signals without using the control line.
- 2) When the "standard RS-232C mode (b9 = 0, b8 = 1)" is specified, use a cross cable to connect equipment having the terminal specifications, and use a straight cable to connect equipment having the modem specifications.
- 3) When the "RS-232C interlink connection mode (b9 = 1, b8 = 1)" is specified, the sending request (RS) signal works as the receiving enable signal for the 232IF. When the 232IF receives data beyond the maximum number of receivable bytes (BFM #2), it turns OFF the receiving enable (RS) signal to ask the counterpart equipment to suspend sending.
 At this time, by withdrawing the contents of the received data buffer to data registers in the PLC using a sequence program, the 232IF can continuously receive the remaining data.
 When this mode is specified, make sure to perform the interlink connection for RS-232C.

→ For the wiring of equipment according to each setting, refer to Chapter 4.
 → For the operation of the control line, refer to Section 5.5.

4. b11 and b10 (CR and LF addition)

The following specification methods are applicable:

- 1) Both CR and LF are not added (b11 = 0, b10 = 0).
 - 2) Only CR is added (b11 = 0, b10 = 1).
 - 3) Both CR and LF are added (b11 = 1, b10 = 1).
- For the CR/LF addition format, refer to the communication format list above.

A	Common Items
B	N:N Network
C	Parallel Link
D	Computer Link
E	Inverter Communication
F	Non-Protocol Communication (RS/RS2 Instruction)
G	Non-Protocol Communication (FX2N-232IF)
H	Programming Communication
I	Remote Maintenance

5. b13 and b12 (absence/presence of check sum and ASCII-Hexadecimal conversion)

The following specification methods are applicable:

- 1) Both the check sum and ASCII-Hexadecimal conversion are not provided (b13 = 0, b12 = 0).
 - 2) Only the ASCII-Hexadecimal conversion is provided (b13 = 0, b12 = 1).
 - 3) Only the check sum is provided (b13 = 1, b12 = 0).
 - 4) Both the check sum and ASCII-Hexadecimal conversion are provided (b13 = 1, b12 = 1).
- For the check sum addition format, refer to the communication format list above.

<ASCII-Hexadecimal conversion>

When "ASCII-Hexadecimal conversion provided" is specified, the hexadecimal numeric value data (0 to F) inside the send data buffer (BFM #1001 to 1256) is converted into ASCII data before being sent. And the received ASCII data is converted into the hexadecimal numeric value data (0 to F) before being stored in the received data buffer (BFM #2001 to 2256).

The number of sent/received bytes at this time indicates the number of hexadecimal data.

<Sending format in conversion from hexadecimal data into ASCII data>

Example: When the send data is "10ABH", the header is "STX" and the terminator is "ETX"

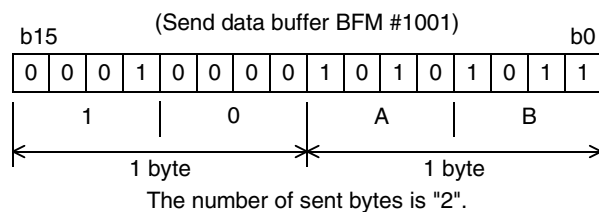

Data is converted into ASCII data when being sent.

S	A	B	1	0	E
T	A	B	1	0	T
X	A	B	1	0	X
02H	41H	42H	31H	30H	03H

<Receiving format in conversion from ASCII data into hexadecimal data>

Example: When the received data is "10ABH", the header is "STX" and the terminator is "ETX"

S	A	B	1	0	E
T	A	B	1	0	T
X	A	B	1	0	X
02H	41H	42H	31H	30H	03H

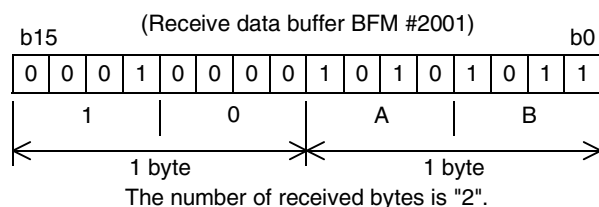

6. b14 (send/receive data buffer data length)

The data is handled as shown below according to the buffer data length.

1) 16-bit (b14 = 0)

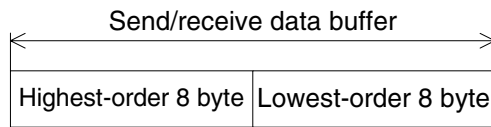

16-bit data is divided into lowest-order 8-bit and highest-order 8-bit when being sent or received.

Example of send data buffer

S	BFM	BFM	BFM	BFM	E
T	#1001	#1001	#1002	#1002	T
X	lowest-order byte	highest-order byte	lowest-order byte	highest-order byte	X

2) 8-bit (b14 = 1)

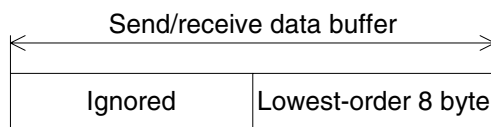

Highest-order 8-bit are ignored. Only lowest-order 8-bit are sent and received as valid data.

Example of send data buffer

S	BFM	BFM	BFM	BFM	E
T	#1001	#1002	#1003	#1004	T
X	lowest-order byte	lowest-order byte	lowest-order byte	lowest-order byte	X

A

Common Items

B

N:N Network

C

Parallel Link

D

Computer Link

E

Inverter Communication

F

Non-Protocol Communication (RS/RS2 Instruction)

G

Non-Protocol Communication (FX2N-2321F)

H

Programming Communication

I

Remote Maintenance

5.4.3 Command <BFM #1>

The BFM #1 gives a command for sending or receiving data or resetting the status information to the 232IF.

Bit	Contents
b0	Sending/receiving enable (ER ON)
b1	Sending command
b2	Receiving complete flag reset command
b3	Error reset

1. b0 (sending/receiving enable)

While b0 is ON, the 232IF can send and receive data.

Because the contents of the following set items are determined at the rising edge of b0, transfer these values in advance using TO instruction before setting b0 to ON:

- BFM #0 (communication format)
- BFM #9 and 8 (receiving header)
- BFM #11 and 10 (receiving terminator)

At the rising edge of b0, the error occurrence status (BFM #28, b3) and error code (BFM #29) are cleared.

2. b1 (sending command)

At the rising edge of b1, the contents of the send data buffer (BFM #1001 to 1256) are sent by as much as the number of bytes to be sent (BFM #1000) to the counterpart equipment.

When sending is completed, the sending complete status (BFM #28, b0) is set to ON. When the next sending command (b1) is given, the sending complete status (BFM #28, b0) is automatically set to OFF.

When the sending command is given, the contents of the following set items are determined:

- BFM #5 and 4 (sending header)
- BFM #7 and 6 (sending terminator)

3. b2 (receiving complete flag reset command)

When b2 is set to ON, the following items are cleared:

- BFM #28, b1 (receiving complete)
- BFM #2000 (number of received bytes)
- BFM #2001 to 2256 (receive data buffer)

After receiving is completed, it is necessary to clear the receiving complete status (BFM #28, b1) because the 232IF cannot receive next data while b1 of the BFM #28 remains ON.

When the receiving complete flag reset command is given, the contents of the following set items are determined:

- BFM #9 and 8 (receiving header)
- BFM #11 and 10 (receiving terminator)

In the RS-232C interlink connection mode (BFM #0, b9 = 1, b8 =1), the receiving complete flag reset command works as the receiving continue command for receiving data beyond the maximum number of receivable bytes (BFM #2), and clears the following items:

- BFM #28, b4 (receiving suspended)
- BFM #2000 (number of received bytes)
- BFM #2001 to 2256 (receive data buffer)
- BFM #2257 to 2271 (preliminary receive data buffer)

The receiving enable (RS) signal is automatically set to ON.

4. b3 (error reset)

When b3 is set to ON, the contents of the error occurrence status (BFM #28, b3) and error code (BFM #29) are cleared.

5.4.4 Maximum number of receivable bytes <BFM #2>

Setting range: 1 to 512 bytes (when the buffer data length is 16-bit)
 1 to 256 bytes (when the buffer data length is 8-bit)
 "0" is handled as "512" or "256 bytes". The initial value is "0".

This bit specifies the maximum number of bytes which can be received by the 232IF.

When the 232IF receives the maximum number of receivable bytes, it sets the receiving complete flag (BFM #28, b1) to ON.

If the receiving terminator (BFM #11 and 10) or receiving timeout time (BFM #3) are set, the 232IF recognizes that receiving is completed even if the already received data does not reach the maximum number of receivable bytes when the either condition is satisfied.

5.4.5 Receiving timeout time <BFM #3>

Setting range: 1 to 32767 (× 10 ms)
 "0" is regarded as no timeout time. The initial value is "0".

This bit specifies the limit of waiting time for receive data.

When the 232IF does not receive the next set of data within the receiving timeout time after the receiving edge of each data, the receiving timeout flag (BFM #28, b2) turns ON. At this time, the 232IF recognizes that receiving is completed, and sets the receiving complete flag (BFM #28, b1) to ON.

5.4.6 Sending header <BFM #5 (highest-order 2 bytes) and BFM #4 (lowest-order 2 bytes)>

Setting range: 4 bytes maximum, 0 suppression
 The initial value is "0" (no sending header).

Up to four headers can be specified for the send data for the 232IF. When the number of headers is less than 4, "0" in upper positions is ignored (0 suppression) and is not transferred.

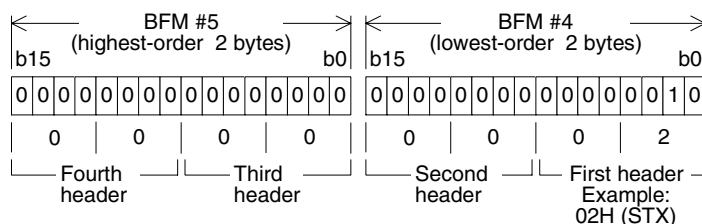

The transfer order is "fourth header → third header → second header → first header" when four headers are set.

5.4.7 Sending terminator <BFM #7 (highest-order 2 bytes) and BFM #6 (lowest-order 2 bytes)>

Setting range: 4 bytes maximum, 0 suppression
 The initial value is "0" (no sending terminator).

Up to four terminators can be specified for the send data for the 232IF. When the number of terminators is less than 4, "0" in upper positions is ignored (0 suppression) and is not transferred.

For the terminator transferred first, specify an ASCII code from "01H" to "1FH". (For other terminators after that, any ASCII code other than "01H" to "1FH" can be specified.)

The register structure and transfer order are the same as those of the sending header described above.

5.4.8 Receiving header <BFM #9 (highest-order 2 bytes) and BFM #8 (lowest-order 2 bytes)>

Setting range: 4 bytes maximum, 0 suppression
 The initial value is "0" (no sending header).

Up to four headers can be specified for the received data for the 232IF. When the number of headers is less than 4, "0" in upper positions is ignored (0 suppression) and is not transferred.

The register structure and transfer order are the same as those of the sending header described above.

A	Common Items
B	N:N Network
C	Parallel Link
D	Computer Link
E	Inverter Communication
F	Non-Protocol Communication (RS/RS2 Instruction)
G	Non-Protocol Communication (FX2N-232IF)
H	Programming Communication
I	Remote Maintenance

5.4.9 Receiving terminator <BFM #11 (highest-order 2 bytes) and BFM #10 (lowest-order 2 bytes)>

Setting range: 4 bytes maximum, 0 suppression

The initial value is "0" (no sending terminator).

Up to four terminators can be specified for the received data for the 232IF. When the number of terminators is less than 4, "0" in upper positions is ignored (0 suppression) and is not transferred.

For the terminator received first, specify an ASCII code from "01H" to "1FH". (For other terminators after that, any ASCII code other than "01H" to "1FH" can be specified.)

The register structure and transfer order are the same as those of the sending header described above.

5.4.10 Receiving suspension waiting time <BFM #12>

Setting range: 0 to 32767 (× 10 ms)

The initial value is "0 ms".

When the 232IF receives data beyond the maximum number of receivable bytes (BFM #2) in the RS-232C interlink connection mode (BFM #0, b9 = 1, b8 = 1), it sets the receiving enable (RS) signal to OFF to ask the counterpart equipment to suspend sending.

The BFM #12 sets the time after the receiving enable (RS) signal is set to OFF until the receiving suspended status bit (BFM #28, b4) is set to ON. Make sure that the time set by the BFM #12 is longer than the time after the 232IF sets the receiving enable (RS) signal to OFF until the counterpart equipment completely suspends sending.

If the receiving suspended status bit (BFM #28, b4) is set to ON before the counterpart equipment stops sending, the 232IF cannot receive the remaining data any more.

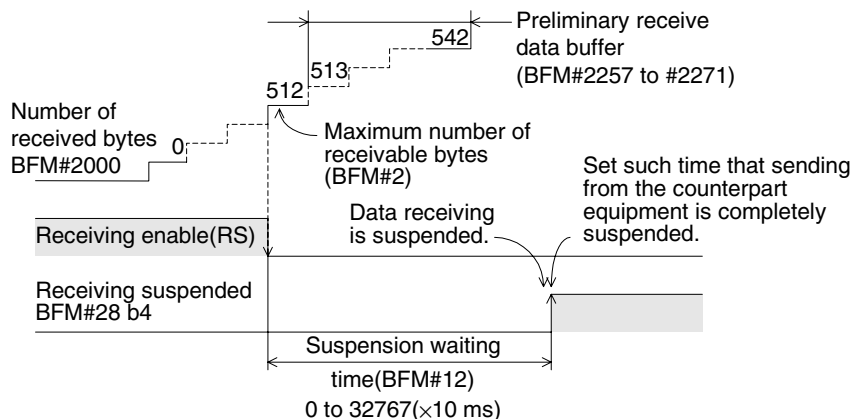

5.4.11 Amount of remaining send data <BFM #13>

Stored value: 0 to 512 (when the buffer data length is 16-bit)

0 to 256 (when the buffer data length is 8-bit)

This buffer stores the value set in the number of bytes to be sent (BFM #1000) subtracted by the number of already sent data.

5.4.12 Amount of received data buffers <BFM #14>

Stored value: 0 to 256+15 ("15" is provided for the preliminary receive data buffer.)

This buffer stores the amount of received data buffers which have already received data among the received data buffers BFM #2001 to 2256 and preliminary receive data buffers for interlink connection mode BFM #2257 to 2271.

5.4.13 Sending sum result <BFM #15>

Initial value: 0

This buffer stores the value of the check sum added to the send data.

The sum check target range and check sum calculation method are as shown below.

Sum check target range and check sum calculation method (Example)

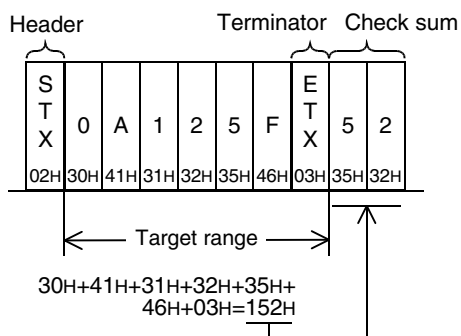

The total of data including the terminators except the first header (only the first one byte) is calculated, the least significant byte of the calculation result is converted into an ASCII code, and then sent and received. The ASCII data is sorted in the order of "upper digit, lower digit".

5.4.14 Receiving sum result <BFM #16>

Initial value: 0

This buffer stores the sum check value of the received data.

If the check sum value added to the received data is different from the receiving sum result, "receiving sum check error" occurs.

The sum check target range and check sum calculation method are the same as those shown in "5.4.13 Sending sum result" above.

5.4.15 Time from CS ON to sending start <BFM #20>

Set value: 0 to 32767 (× 10 ms)

Initial value: 0 ms

This buffer sets the time after the sending enable (CS) signal is set to ON until the 232IF actually starts to send.

When "control line not provided" is specified, this buffer sets the time after the sending command is given until sending is started.

Set proper time according to the modem, etc.

5.4.16 Time from actual sending completion to RS OFF <BFM #21>

Set value: 0 to 32767 (× 10 ms)

Initial value: 0 ms

This buffer sets the time after the 232IF completes sending until RS signal turns OFF and the sending complete flag (BFM #28, b0) turns ON.

Set proper time according to the modem, etc.

A

Common Items

B

N:N Network

C

Parallel Link

D

Computer Link

E

Inverter Communication

F

Non-Protocol Communication (RS/RS2 Instruction)

G

Non-Protocol Communication (FX2N-232IF)

H

Programming Communication

I

Remote Maintenance

5.4.17 Status <BFM #28>

Bit	Contents	Bit	Contents
b0	Sending complete	b8	RS(RTS)
b1	Receiving complete	b9	ER(DTR)
b2	Receiving timeout	b10	Undefined
b3	Error occurrence	b11	Undefined
b4	Receiving suspended	b12	DR(DSR)
b5	Undefined	b13	CD(DCD)
b6	Sending	b14	DS(CTS)
b7	Receiving	b15	CI(RI)

This buffer stores the 232IF status and sending/receiving result as the status information. The PLC can read this buffer using the FROM instruction.

1. b0 (sending complete)

When sending of data as much as the number of bytes to be sent (BFM #1000) is completed, the sending complete flag (b0) is set to ON.

The sending complete flag (b0) is automatically set to OFF when the next sending command (BFM #1, b1) is set to ON.

2. b1 (receiving complete)

When data as much as the maximum number of receivable bytes (BFM #2) is received, the receiving complete flag (b1) is set to ON.

If the receiving terminator (BFM #11 and 10) or receiving timeout time (BFM #3) is set, the 232IF recognizes that receiving is completed even if the already received data does not reach the maximum number of received bytes when the either condition is satisfied.

It is necessary to set to OFF this receiving complete flag in a sequence program. The 232IF is not ready for receiving the next data while this bit is ON. Use the receiving complete flag reset command (BFM #1, b2) to set this bit to OFF.

3. b2 (receiving timeout)

When the receiving timeout time (BFM #3) has come during receiving, the receiving timeout bit (b2) is set to ON. And the receiving complete flag (b1) is set to ON also.

The receiving timeout status (b2) is set to OFF when the receiving complete flag reset command (BFM #1, b2) is executed.

4. b3 (error occurrence)

When an error occurs during sending or receiving, the error occurrence status bit (b3) is set to ON and the contents of the error are stored in the error code (BFM #29).

5. b4 (receiving suspended)

When the 232IF receives data beyond the maximum number of receivable bytes (BFM #2) in the RS-232C interlink connection mode (BFM #0, b9 = 1, b8 = 1), it sets the receiving enable (RS) signal to OFF and asks the counterpart equipment to suspend sending. After the receiving suspension waiting time (BFM #12), the 232IF sets the receiving suspended status bit (b4) to ON.

For continuously receiving data beyond the maximum number of receivable bytes (BFM #2) in the interlink connection mode, it is necessary to monitor the rising edge of this receiving suspended status bit (b4) in a sequence program, and withdraw data as much as the number of received bytes (BFM #2000) or amount of received data buffers (BFM #14) from the received data buffer (BFM #2001 to 2271) to data registers inside the PLC.

6. b6 (sending)

This bit remains ON from when the sending command (BFM #1, b1) is given until the sending complete flag (BFM #28, b0) is set to ON.

7. b7 (receiving)

This bit remains ON from when the head data is received until the receiving complete flag (BFM #28, b1) is set to ON.

8. b8 (RS), b9 (ER), b12 (DR), b13 (CD), b14 (CS) and b15 (CI)

These bits indicate the operation status in their ON/OFF status.

5.4.18 Error code <BFM #29>

For the error codes, refer to Section 7.2.

5.4.19 Model code <BFM #30>

The model code of the 232IF is "K7030".

The model code is a specific code assigned to each special extension equipment. By reading the model code in the PLC, the equipment type can be checked.

5.4.20 Number of bytes to be sent <BFM #1000>

Setting range: 0 to 512 bytes (when the buffer data length is 16-bit)
 0 to 256 bytes (when the buffer data length is 8-bit)

This buffer specifies how many bytes should be sent among 512 bytes/256 words in 16-bit send data buffer (BFM #1001 to 1256).

5.4.21 Send data buffer <BFM #1001 to 1256>

The send data buffers are 16-bit buffers for storing the send data. The send data buffers can store up to 512 bytes/256 words.

Structure of send/receive data buffer

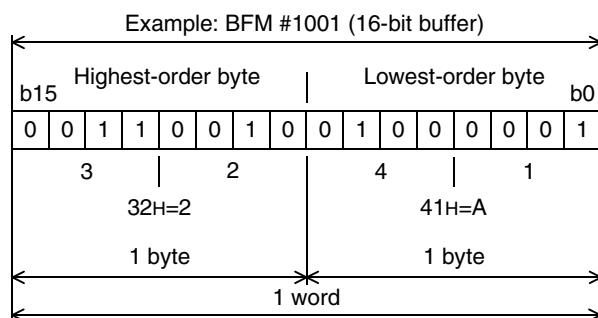

Values in the send data buffers and receive data buffers are handled as hexadecimal values.

5.4.22 Number of received bytes <BFM #2000>

Stored value: 0 to 512+30*¹ bytes (when the buffer data length is 16-bit)
 0 to 256+15*¹ bytes (when the buffer data length is 8-bit)

This buffer stores the number of bytes received from the counterpart equipment. The value stored in this buffer is cleared when the receiving complete flag reset command (BFM #1, b2) is given.

*1. "30" or "15" bytes are provided for the preliminary buffer in the interlink connection mode.

5.4.23 Receive data buffer <BFM #2001 to 2256>

The received data buffers are 16-bit buffers for storing the data received from the counterpart equipment. The received data buffers can store up to 512 bytes/256 words.

The received data buffer structure is same as the send data buffer structure.

The contents of the received data buffer are cleared when the receiving complete flag reset command (BFM #1, b2) is given.

5.4.24 Preliminary receive data buffer for interlink connection mode <BFM #2257 to 2271>

The preliminary receive data buffers are provided for storing the data beyond 512 bytes in the interlink connection mode. The preliminary receive data buffers are used to receive the data sent after the receiving enable (RS) signal is set to OFF until the counterpart equipment suspends sending.

The contents of the preliminary receive data buffer are cleared when the receiving complete flag reset command (BFM #1, b2) is given.

A	Common Items
B	N:N Network
C	Parallel Link
D	Computer Link
E	Inverter Communication
F	Non-Protocol Communication (RS/RS2 Instruction)
G	Non-Protocol Communication (FX2N-232IF)
H	Programming Communication
I	Remote Maintenance

5.5 Operation of Control Line

5.5.1 When control line is not provided [BFM #0, (b9, b8) = (0, 0)]

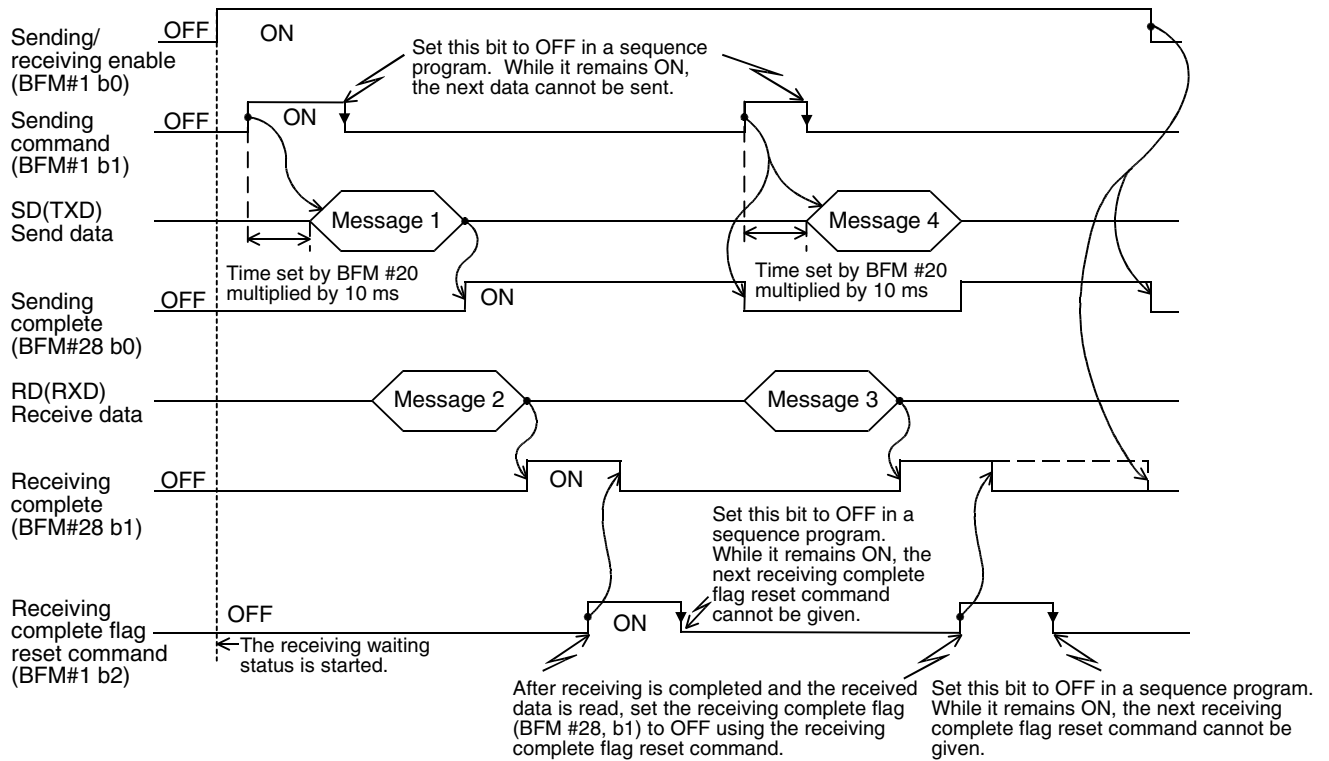

5.5.2 When control line is in standard RS-232C mode [BFM #0, (b9, b8) = (0, 1)]

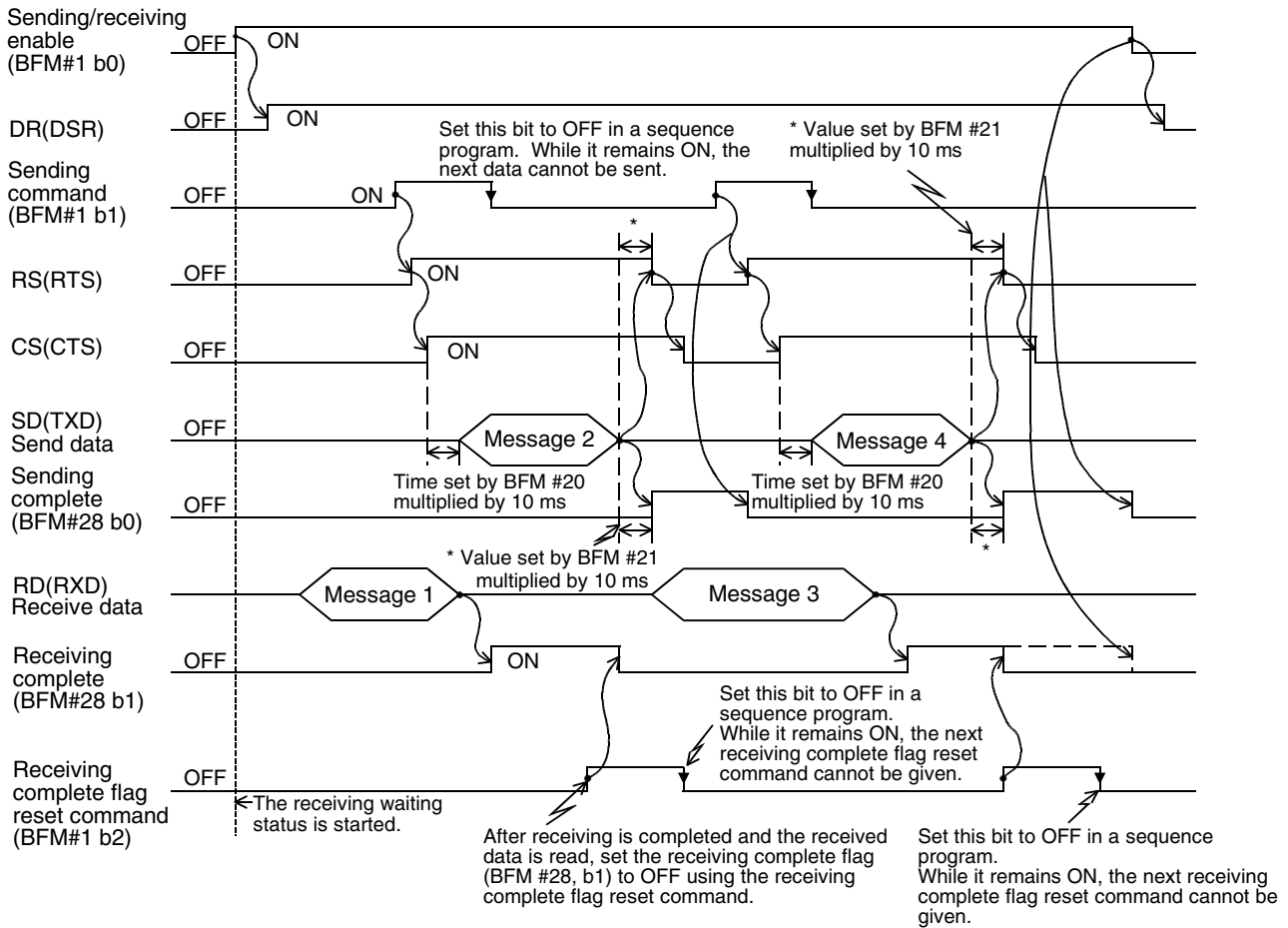

A	Common Items
B	N:N Network
C	Parallel Link
D	Computer Link
E	Inverter Communication
F	Non-Protocol Communication (RS/RS2 Instruction)
G	Non-Protocol Communication (FX2N-2321F)
H	Programming Communication
I	Remote Maintenance

5.5.3 When control line is in RS-232C interlink mode [BFM #0, (b9, b8) = (1, 1)]

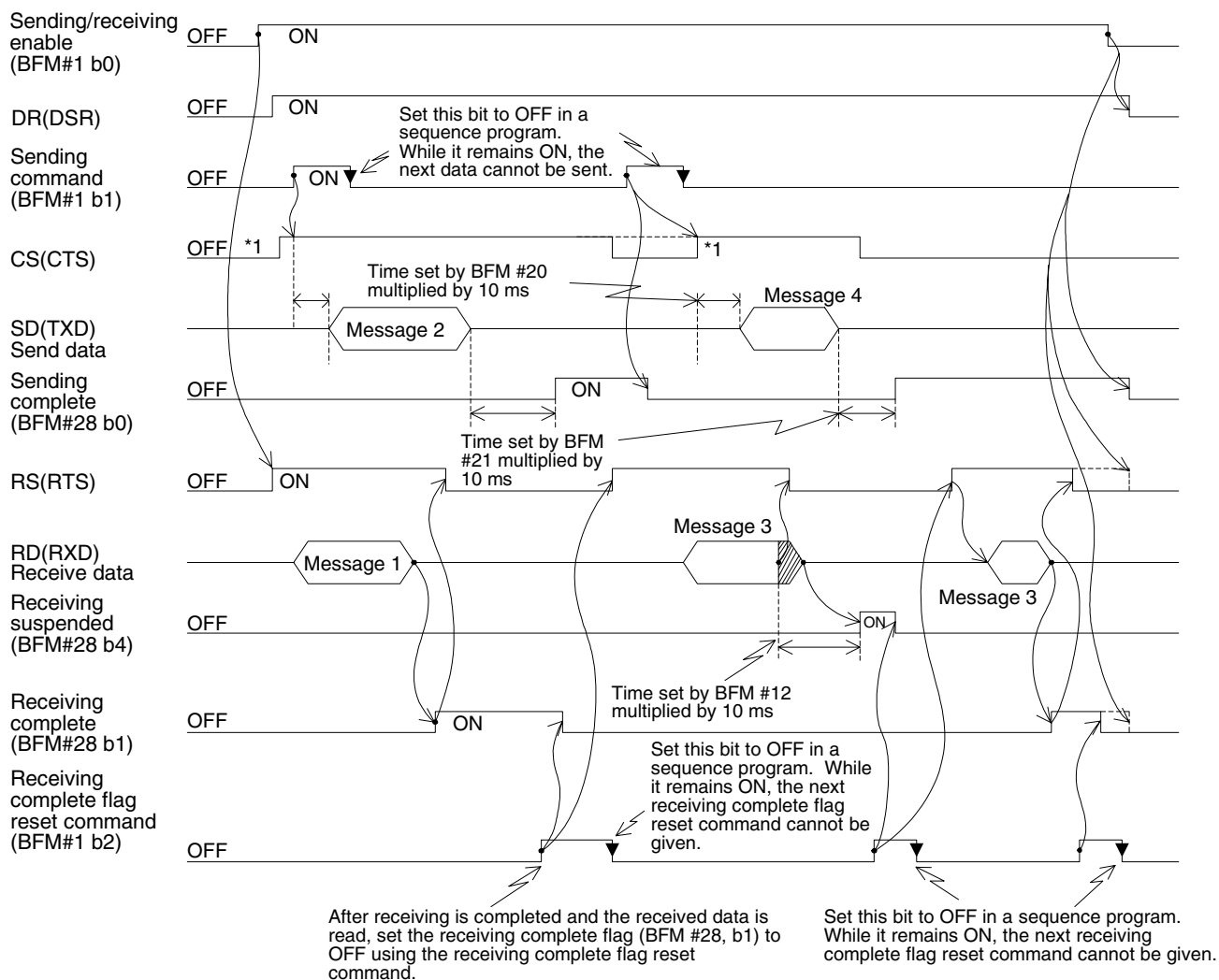

- *1. Make sure that the CS (CTS) signal turns ON in the 232IF while the counterpart equipment is ready to receive.
- *2. When the already received data exceeds the maximum number of receivable bytes specified by the BFM #2, the RS (RTS) signal turns OFF. Accordingly, sending is suspended from the counterpart equipment within 30 bytes when the send/receive data buffer data length is 16-bit (BFM #0, b14= 0), or within 15 bytes when the send/receive data buffer data length is 8-bit (BFM #0, b14= 1). If sending is not suspended, the 232IF cannot receive all sent data.
- *3. Read as much data as the number of received bytes (BFM #14) from the received data buffer (BFM #2001 to 2271) to data registers in the PLC, and then set it to ON.

6. Practical Program Examples

6.1 Example of Sending/Receiving Data Having 16-bit Buffer Length

In this example, data having the 16-bit buffer length is sent and received between the 232IF and equipment having the terminal specifications. In this example, ASCII codes stored in the data registers D201 to D205 in the PLC are sent to the counterpart equipment, and the data received from the counterpart equipment is stored to the data registers D301 to D304 in the PLC.

1. System configuration

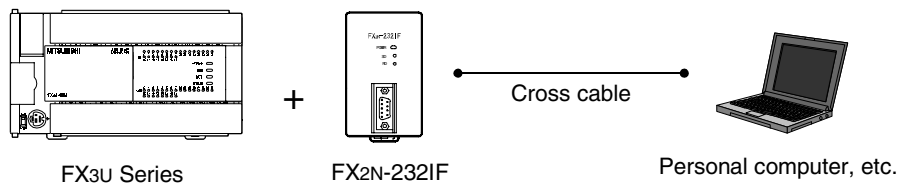

2. Example of setting buffer memory

Suppose that each buffer memory not described here is set to the initial value.

1) Communication format <BFM #0>

Bit	Contents	Setting
b0	Data length	(1) : 8-bit
b1 b2	Parity	(1,1) : Even
b3	Stop bit	(1) : 2-bit
b4 b5 b6 b7	Baud rate	(1001) : 19200 bps
b8 b9	Control line	(00) : Not provided
b10 b11	CR and LF addition	(00) : Not provided
b12 b13	Absence/presence of check sum and ASCII-Hexadecimal conversion	(00) : Not provided
b14	Send/receive data buffer data length	(0) : 16-bit
b15	Undefined	—

← Item to specify 16-bit data

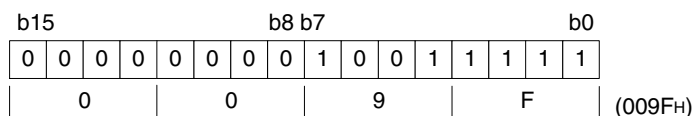

2) Command <BFM #1>

M0 → b0: Sending/receiving enable (ER ON)

M1 → b1: Sending command

M2 → b2: Receiving complete flag reset command

M3 → b3: Error reset

3) Maximum number of receivable bytes <BFM #2>

8 bytes

3. Operation chart

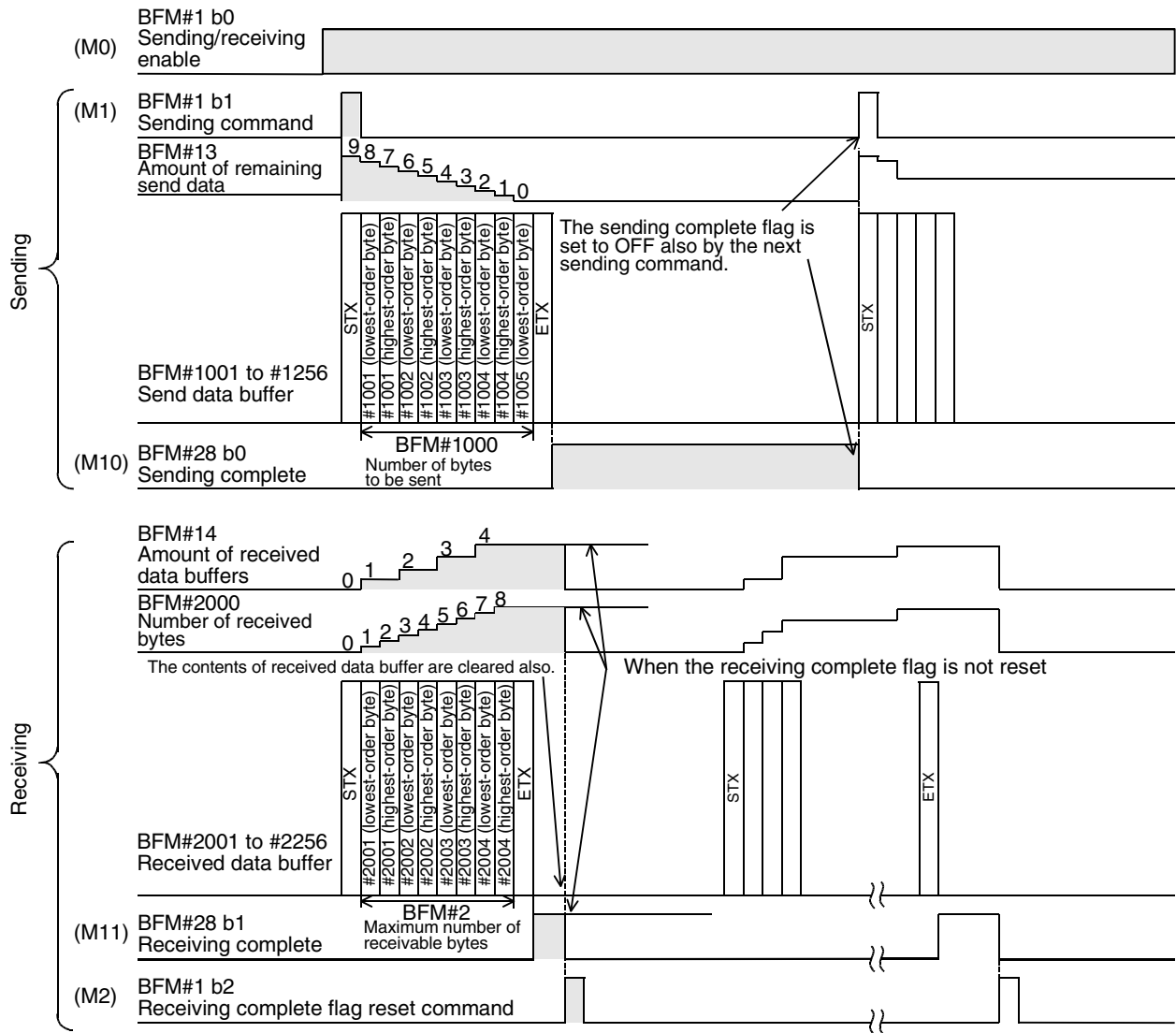

A	Common Items
B	N:N Network
C	Parallel Link
D	Computer Link
E	Inverter Communication
F	Non-Protocol Communication (RS/RS2 Instruction)
G	Non-Protocol Communication (FX2N-2321F)
H	Programming Communication
I	Remote Maintenance

4. Sequence program example

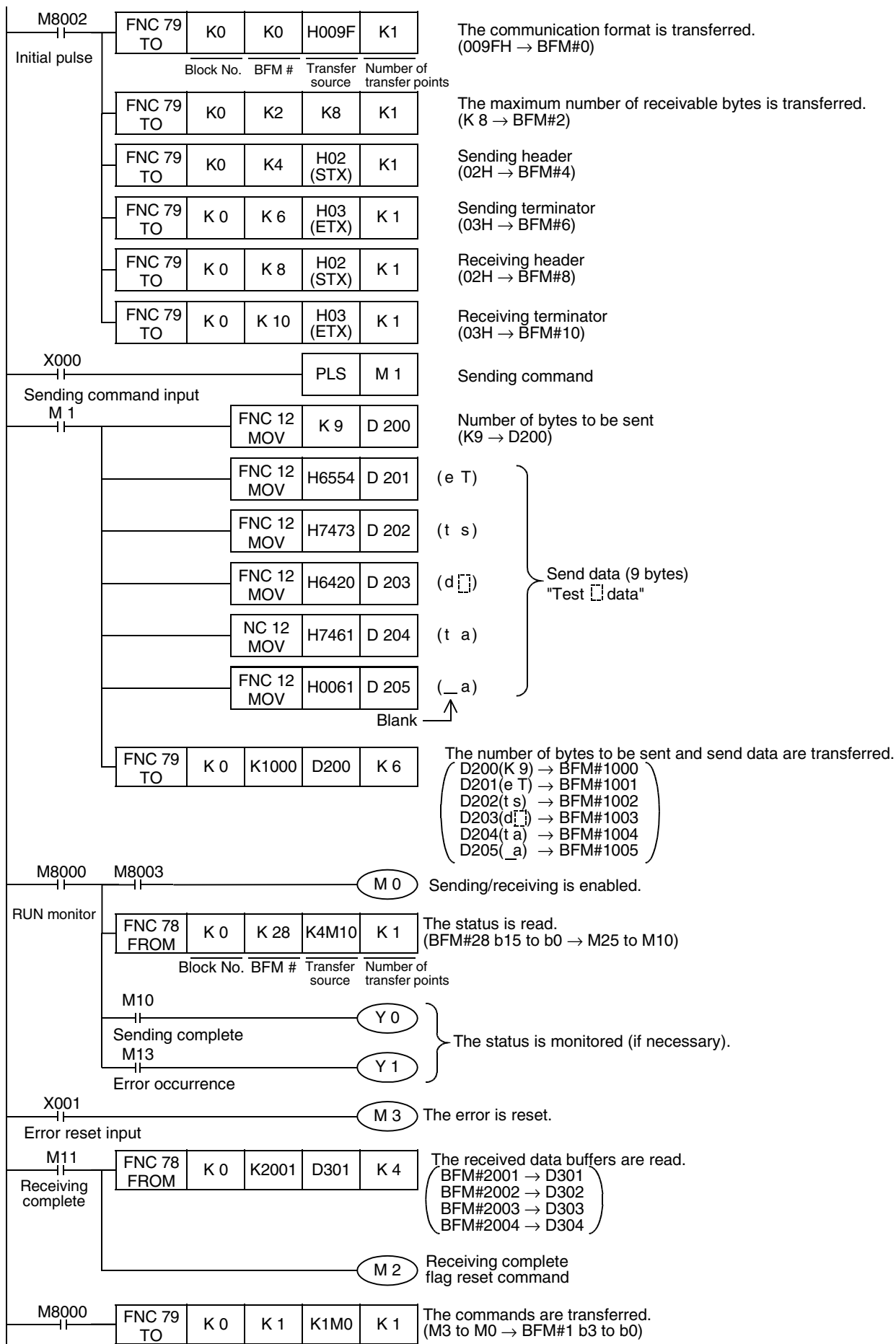

6.2 Sending/Receiving Data Having 8-bit Buffer Length

In this example, data having the 8-bit buffer length is sent and received between the 232IF and equipment having the terminal specifications. In this example, ASCII codes stored in the data registers D201 to D209 in the PLC are sent to the counterpart equipment, and the data received from the counterpart equipment is stored to the data registers D301 to D308 in the PLC.

1. System configuration

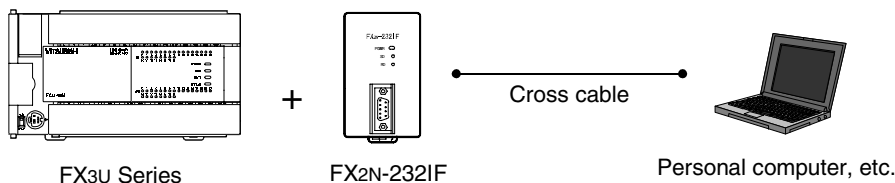

2. Example of setting buffer memory

Suppose that each buffer memory not described here is set to the initial value.

1) Communication format <BFM #0>

Bit	Contents	Setting
b0	Data length	(1) : 8-bit
b1 b2	Parity	(1,1) : Even
b3	Stop bit	(1) : 2-bit
b4 b5 b6 b7	Baud rate	(1001) : 19200 bps
b8 b9	Control line	(00) : Not provided
b10 b11	CR and LF addition	(00) : Not provided
b12 b13	Absence/presence of check sum and ASCII-Hexadecimal conversion	(00) : Not provided
b14	Send/receive data buffer data length	(0) : 8-bit ← Item to specify 8-bit data
b15	Undefined	—

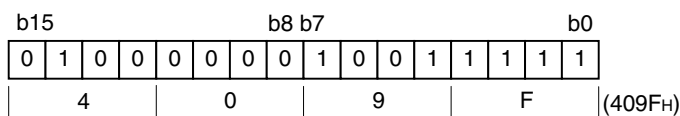

2) Command <BFM #1>

M0 → b0: Sending/receiving enable (ER ON)

M1 → b1: Sending command

M2 → b2: Receiving complete flag reset command

M3 → b3: Error reset

3) Maximum number of receivable bytes <BFM #2>

8 bytes

4) Header and terminator <BFM #4 to 11>

BFM #4 and 8 (sending header and receiving header): 02H (STX)

BFM #6 and 10 (sending terminator and receiving terminator): 03H (ETX)

- 5) Status <BFM #28>
 b0 → M10: Sending complete b8 → M18 : RS(RTS)
 b1 → M11: Receiving complete b9 → M19 : ER(DTR)
 b2 → M12: Receiving timeout b10 → M20: Undefined
 b3 → M13: Error occurrence b11 → M21: Undefined
 b4 → M14: Receiving suspended b12 → M22: DR(DSR)
 b5 → M15: Undefined b13 → M23: CD(DCD)
 b6 → M16: Sending b14 → M24: CS(CTS)
 b7 → M17: Receiving b15 → M25: CI(RI)
- 6) Number of bytes to be sent <BFM #1000>
 9 bytes
- 7) Send data buffer <BFM #1001 and later>
 The send data "Test data" in ASCII codes is provided to 9 bytes (as specified in the buffer for the number of bytes to be sent described above).

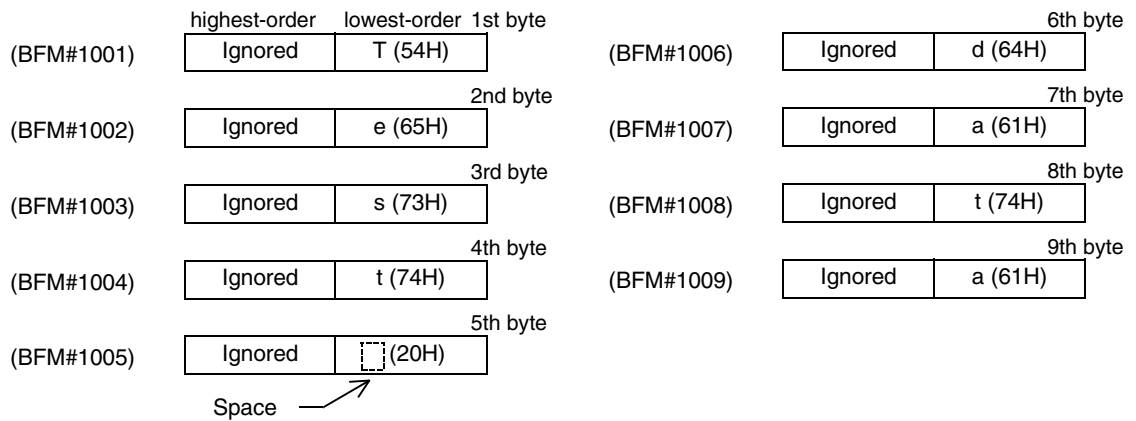

- 8) Receive data buffer <BFM #2001 and later>
 Eight bytes specified by the maximum number of receivable bytes (BFM #2) are read to the data registers D301 to D308 in the PLC.

3. Operation chart

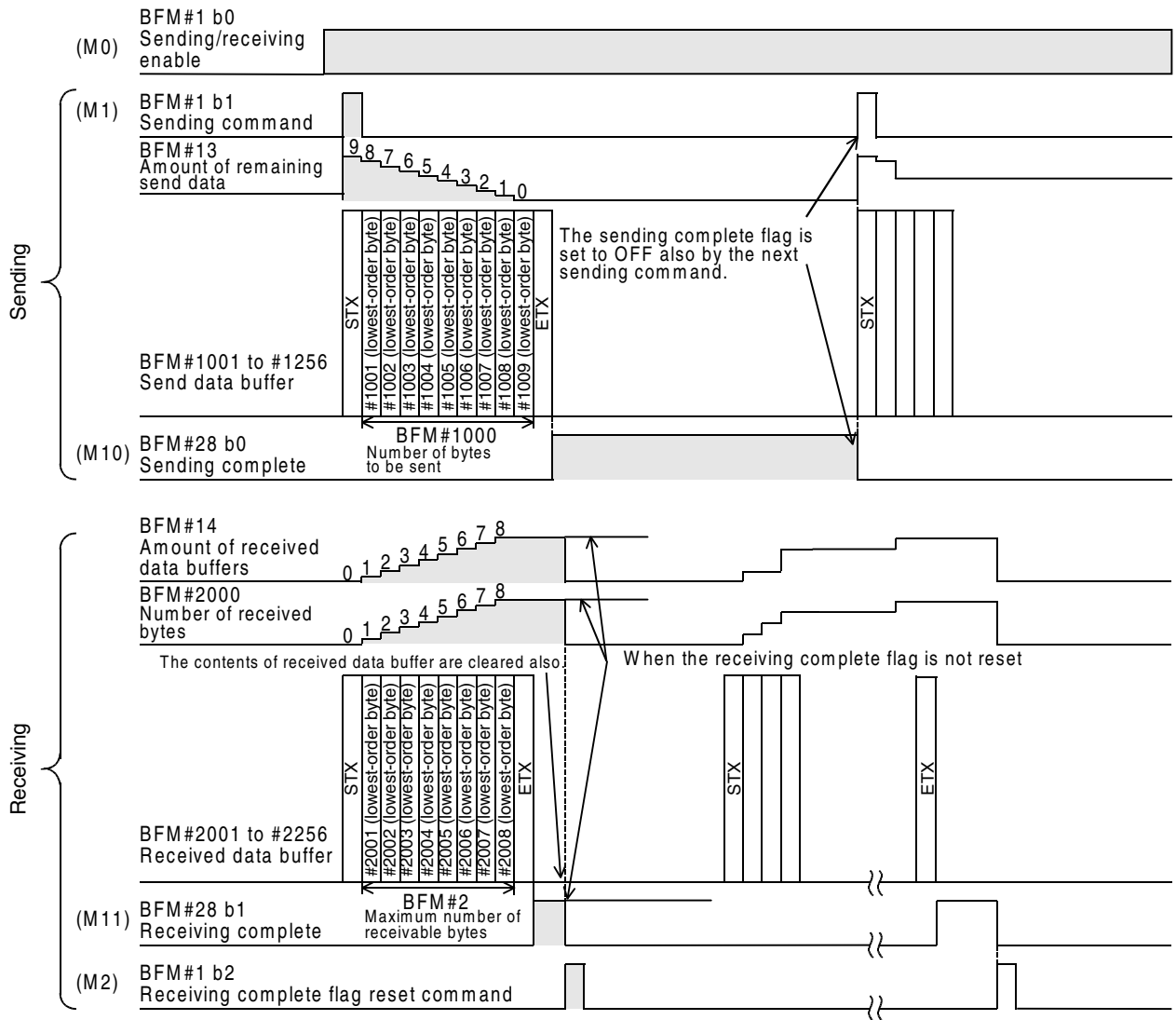

A	Common Items
B	N:N Network
C	Parallel Link
D	Computer Link
E	Inverter Communication
F	Non-Protocol Communication (RS/RS2 Instruction)
G	Non-Protocol Communication (FX2N-2321F)
H	Programming Communication
I	Remote Maintenance

4. Program example

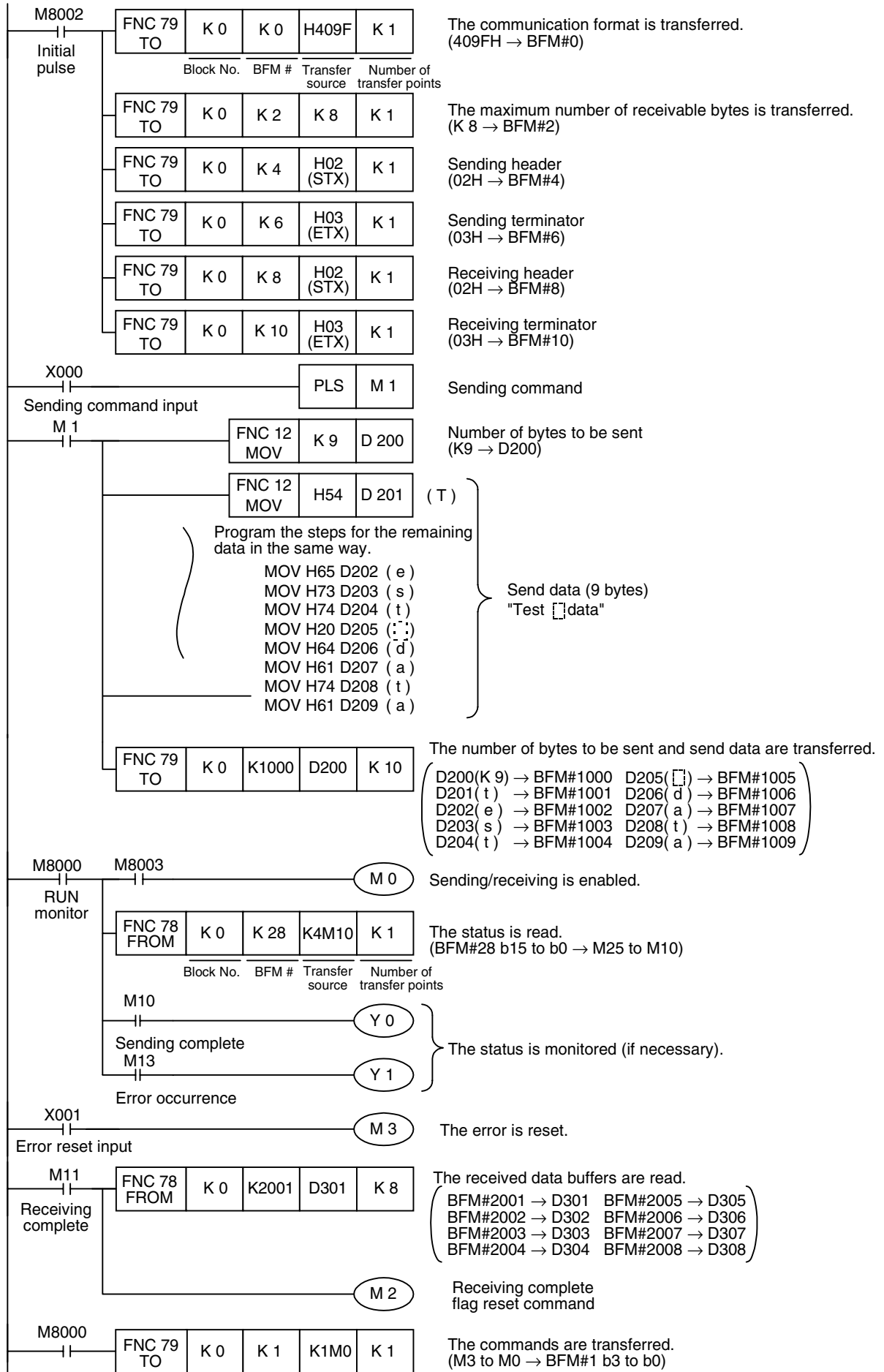

7. Troubleshooting

7.1 Check Items

- 1) Check the POWER LED in the 232IF.
 - While the POWER LED is ON, the drive power is being supplied normally.
 - If the POWER LED is OFF, the drive power is abnormal.
- 2) Verify that the power supply is correctly wired to terminals in the 232IF.
- 3) Check the SD LED and RD LED in the 232IF.
 - If the RD LED does not turn ON when the 232IF receives data or if the SD LED does not turn ON when the 232IF sends data, check the connection and wiring.
 - If the RD LED turns ON when the 232IF receives data or if the SD LED turn ON when the 232IF sends data, the installation and wiring are normal.
- 4) Verify that the communication setting (BFM #0) in the 232IF is aligned correctly with the communication setting in the external counterpart equipment. If the communication setting is not aligned, align it.
- 5) Check the timing at which data is sent and received. For example, when sending data, verify that the counterpart equipment is ready to receive.
- 6) When the terminator is not used, verify that the quantity of data to be sent matches the receivable data quantity. If the quantity of send data may vary, use the terminator.
- 7) Verify that the external equipment is operating normally.
- 8) Verify that the adopted data format is equivalent. If the data format is different, modify it.

7.2 Error Codes

When an error occurs while data is being sent or received, the 232IF sets bit 3 of the BFM #28 to ON, and stores the corresponding error code to the BFM #29.

Code	Contents	Cause and countermeasures
0	No error	—
1	Receiving parity error, overrun error or framing error	The communication format such as the baud rate does not agree. The control timing does not agree.
2	Undefined	—
3	Defective received character	The received data is not ASCII codes.
4	Receiving sum check error	The sent sum does not agree with the received sum result (BFM #16).
5	Receive data buffer overflow (only in interlink connection mode)	The number of received bytes exceeds "512+30" bytes. Decrease the maximum number of receivable bytes (BFM #2), and increase the preliminary receive data buffer area.
6	Baud rate setting error	Non-existing baud rate is specified.
7	Receiving CR error	CR is not located in the specified position.
8	Receiving LF error	LF is not located in the specified position.
9	Head sending/receiving terminator setting error	The head terminator is something other than 01H to 1FH.
10	Receiving terminator error	The terminator is not located in the specified position. Or the terminator does not agree.
11	Undefined	—
12	Transmission order error	The transmission order does not agree.

A	Common Items
B	N:N Network
C	Parallel Link
D	Computer Link
E	Inverter Communication
F	Non-Protocol Communication (RS/RS2 Instruction)
G	Non-Protocol Communication (FX2N-232IF)
H	Programming Communication
I	Remote Maintenance

MEMO

FX Series Programmable Controllers

User's Manual [Programming Communication]

Foreword

This manual explains "programming communication" provided in MELSEC-F FX Series Programmable Controllers and should be read and understood before attempting to install or use the unit. Also, store this manual in a safe place so that you can take it out and read it whenever necessary. Always forward it to the end user.

This manual confers no industrial property rights or any rights of any other kind, nor does it confer any patent licenses. Mitsubishi Electric Corporation cannot be held responsible for any problems involving industrial property rights which may occur as a result of using the contents noted in this manual.

© 2005 MITSUBISHI ELECTRIC CORPORATION

A
Common Items

B
N:N Network

C
Parallel Link

D
Computer Link

E
Inverter Communication

F
Non-protocol Communication (RS/RS2 Instruction)

G
Non-protocol Communication (FX2N-232IF)

H
Programming Communication

I
Remote Maintenance

1. Outline

This chapter explains the outline of sequence programming communication.

1.1 Outline of System

Sequence programming communication transfers programs and monitors devices when a programming tool of the PLC is connected.

- 1) A PLC can be directly connected to the RS-232C port in a personal computer with one cable.
- 2) Sequence programs can be transferred and devices can be monitored through the USB port in a personal computer. This function is not provided in the FX2(FX) and FX2c Series.
- 3) It is possible to monitor devices using one programming tool, and change programs using another programming tool. This function is not provided in the FX2(FX), FX2c, and FX0N Series.
- 4) Two display units or one display unit and one programming tool can be connected at the same time. This function is not provided in the FX2(FX), FX2c, and FX0N Series.

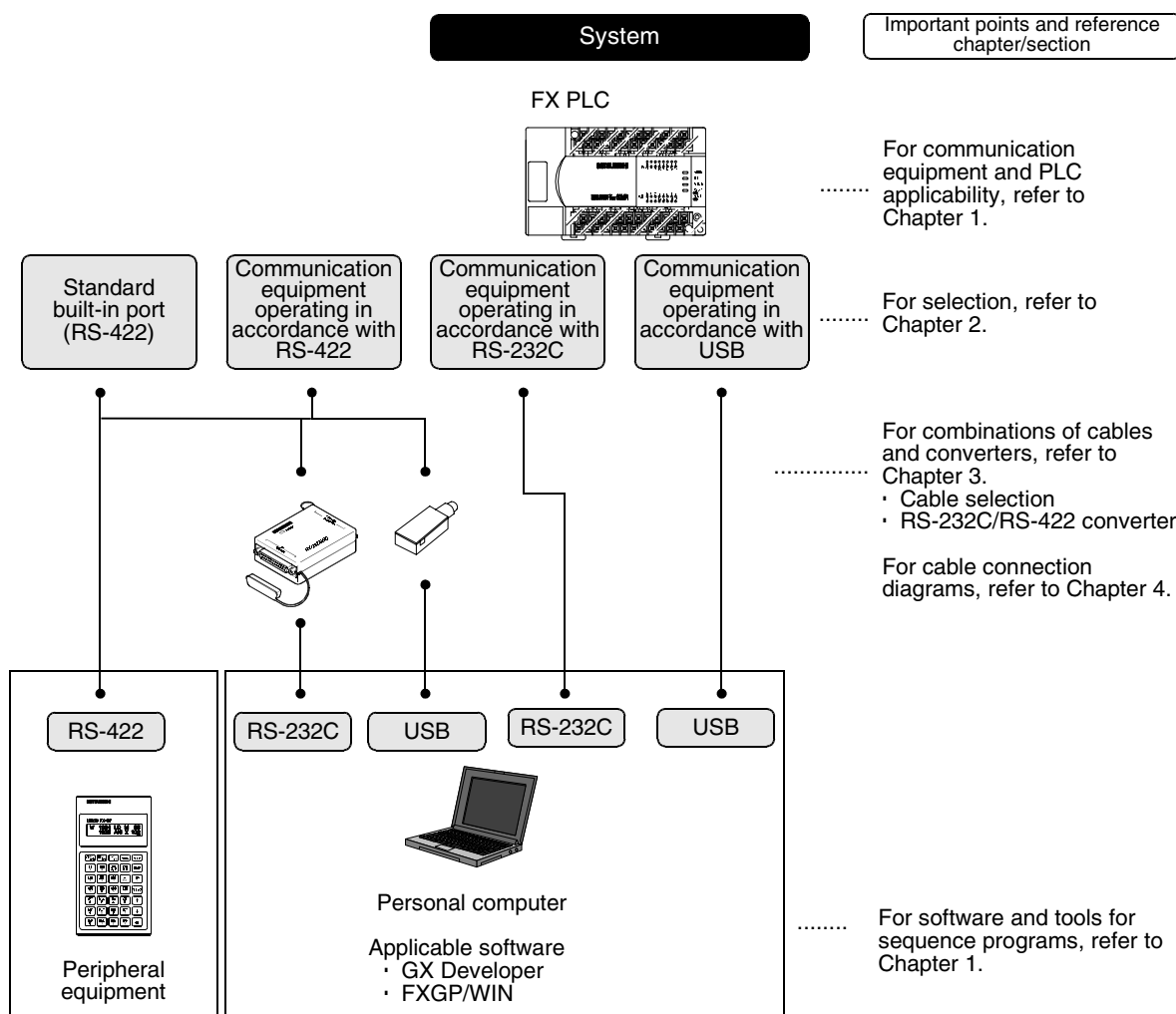

A	Common Items
B	N:N Network
C	Parallel Link
D	Computer Link
E	Inverter Communication
F	Non-Protocol Communication (RS/RS2 Instruction)
G	Non-Protocol Communication (FX2N-232IF)
H	Programming Communication
I	Remote Maintenance

1.2 Major Procedures until Operation

The flow chart below shows the procedures for setting programming communication until data link:

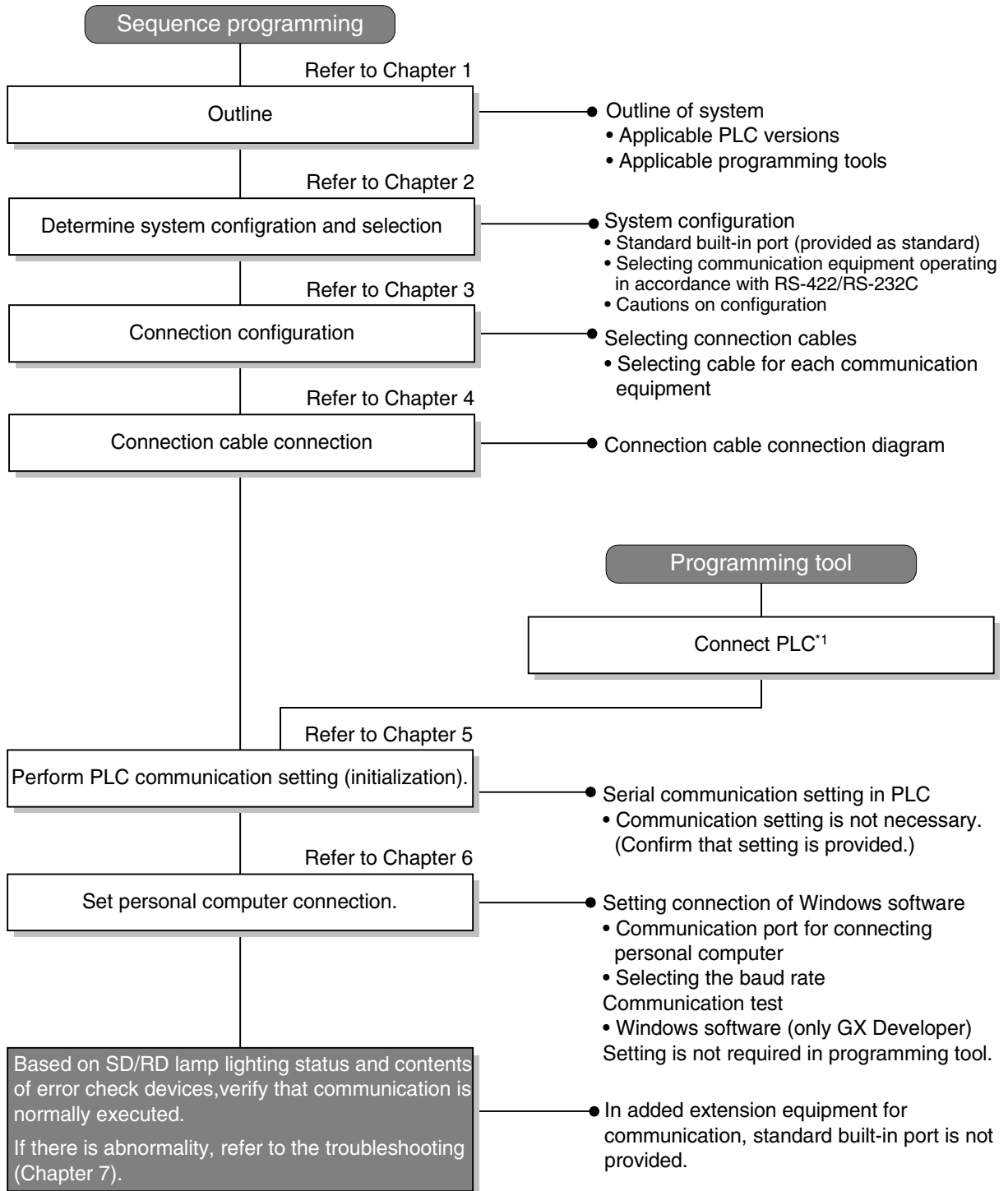

*1 For the method to connect a programming tool to a PLC, refer to this manual or the manual of each programming tool.
 For the details including the operation methods, refer to the manual of each programming tool.

1.3 Communication Type Applicability in PLC

1.3.1 Applicable versions

The communication types are applicable in the following versions.

✓: Applicable (If applicable versions are limited, they are described inside ().)

—: Not applicable

PLC	Standard built-in port	Optional communication equipment operating in accordance with RS-422	Optional communication equipment operating in accordance with RS-232C	Optional communication equipment operating in accordance with USB	Remarks
FX3UC Series	✓	✓	✓	✓	Programming communication is provided in all of the standard built-in port and optional communication equipment operating in accordance with RS-422/RS-232C/USB.
FX3U Series	✓	✓	✓	✓	
FX2NC Series	✓	—	✓	—	
FX2N Series	✓	✓	✓	—	
FX1NC Series	✓	—	✓	—	
FX1N Series	✓	✓	✓	—	
FX1S Series	✓	✓	✓	—	
FX0N Series	✓	—	—	—	Programming communication is provided in all of the standard built-in port, but is not provided in any optional communication equipment operating in accordance with RS-422/RS-232C/USB.
FX0S Series	✓	—	—	—	
FX0 Series	✓	—	—	—	
FX2C Series	✓	—	—	—	
FX2(FX) Series	✓	—	—	—	
FX1 Series	✓	—	—	—	

1.3.2 Products whose production was stopped

The table below shows series in which production of the main unit, communication equipment, etc. is stopped.

Use the description on system configuration, etc. in this manual for maintenance.

PLC	Date when production was stopped	Remarks
FX0 Series	June 30, 2002	Maintenance is offered within 7 years from the end of production (until June 30, 2009).
FX2C Series		
FX2(FX) Series		
FX1 Series		

A	Common Items
B	N:N Network
C	Parallel Link
D	Computer Link
E	Inverter Communication
F	Non-Protocol Communication (RS/RS2 Instruction)
G	Non-Protocol Communication (FX2N-232IF)
H	Programming Communication
I	Remote Maintenance

1.4 Programming Tool Applicability

1.4.1 For applicable versions

The programming tool is applicable in each FX Series from the following version:

1. Japanese versions

✓: Applicable (If applicable versions are limited, they are described inside ().)
 —: Not applicable

Model name (Media model name is shown below)	Applicability (applicable version)	Remarks
FX3U and FX3UC PLCs		
GX Developer SW□D5C(F)-GPPW-J	✓ (Ver. SW8 P or later) Ver. 8.13P	Select the model "FX3UC"
FX2N and FX2NC PLCs		
GX Developer SW□D5C(F)-GPPW-J	✓ (Ver. SW2 A or later)	Select the model "FX2N/FX2NC"
FX-PCS/WIN SW0PC-FXGP/WIN	✓ (Ver. 2.00 or later)	
FX-PCS-KIT/98 SW1PC-FXGP/98(-3,-5)	✓ (Ver. 4.00 or later)	
FX-PCS/98-3 SW1PC-FXGP/98-3	✓ (Ver. 4.00 or later)	
FX-PCS-KIT/V-3 SW1-PC-FXGP/V3	✓ (Ver. 2.00 or later)	
FX-A7PHP-KIT SW1RX-GPPFX	✓ (Ver. 3.00 or later)	
FX-20P(-SET0) FX-20P-MFXC	✓ (Ver. 4.00 or later)	
FX-10P(-SET0)	✓ (Ver. 3.00 or later)	
GOT-F900 Series display units F940WGOT-TWD F940GOT-*WD F940GOT-*BD-H F940GOT-*BD-RH	✓ (Refer to right column)	F940WGOT-TWD (Ver. 1.00 or later) F940GOT-LWD, F940GOT-SWD (Ver. 1.00 or later) F940GOT-LBD-H, F940GOT-SBD-H (Ver. 1.00 or later) F940GOT-LBD-RH, F940GOT-SBD-RH (Ver. 1.00 or later)
FX1S, FX1N and FX1NC PLCs		
GX Developer SW□D5C(F)-GPPW-J	✓ (Ver. SW5 A or later)	Select the model "FX1S/FX1N"
FX-PCS/WIN SW0PC-FXGP/WIN	✓ (Ver. 4.00 or later)	
FX-PCS/98-3 SW1PC-FXGP/98-3	✓ (Ver. 5.00 or later)	
FX-20P(-SET0) FX-20P-MFXD	✓ (Ver. 5.00 or later)	
FX-10P(-SET0)	✓ (Ver. 4.00 or later)	
GOT-F900 Series display units F940WGOT-TWD F940GOT-*WD F940GOT-*BD-H F940GOT-*BD-RH	✓ (Refer to right column)	F940WGOT-TWD (Ver. 1.00 or later) F940GOT-LWD, F940GOT-SWD (Ver. 1.00 or later) F940GOT-LBD-H, F940GOT-SBD-H (Ver. 1.00 or later) F940GOT-LBD-RH, F940GOT-SBD-RH (Ver. 1.00 or later)

2. English versions

✓: Applicable (If applicable versions are limited, they are described inside ().)
 —: Not applicable

Model name (Media model name is shown below)	Applicability (applicable version)	Remarks
FX3u and FX3UC PLCs		
GX Developer SW□D5C(F)-GPPW-E	✓ (Ver. SW8 P or later) Ver. 8.13P	Select the model "FX3UC"
FX2N and FX2NC PLCs		
GX Developer SW□D5C(F)-GPPW-E	✓ (Ver. SW2 A or later)	Select the model "FX2N/FX2NC"
FX-PCS/WIN-E SW0PC-FXGP/WIN-E	✓ (Ver. 1.00 or later)	
FX-20P-E(-SET0) FX-20P-MFXC-E	✓ (Ver. 3.00 or later)	
FX-10P-E	✓ (Ver. 3.00 or later)	
GOT-F900 Series display units F940WGOT-TWD-E F940GOT-*WD-E F940GOT-*BD-H-E F940GOT-*BD-RH-E	✓ (Refer to right column.)	F940WGOT-TWD-E (Ver. 1.00 or later) F940GOT-LWD-E, F940GOT-SWD-E (Ver. 1.00 or later) F940GOT-LBD-H-E, F940GOT-SBD-H-E (Ver. 1.00 or later) F940GOT-LBD-RH-E, F940GOT-SBD-RH-E (Ver. 1.00 or later)
FX1S, FX1N and FX1NC PLCs		
GX Developer SW□D5C(F)-GPPW-E	✓ (Ver. SW5 A or later)	Select the model "FX1S/FX1N"
FX-PCS/WIN-E SW0PC-FXGP/WIN-E	✓ (Ver. 3.00 or later)	
FX-20P-E(-SET0) FX-20P-MFXD-E	✓ (Ver. 4.00 or later)	
FX-10P-E	✓ (Ver. 4.00 or later)	
GOT-F900 Series display units F940WGOT-TWD-E F940GOT-*WD-E F940GOT-*BD-H-E F940GOT-*BD-RH-E	✓ (Refer to right column)	F940WGOT-TWD-E (Ver. 1.00 or later) F940GOT-LWD-E, F940GOT-SWD-E (Ver. 1.00 or later) F940GOT-LBD-H-E, F940GOT-SBD-H-E (Ver. 1.00 or later) F940GOT-LBD-RH-E, F940GOT-SBD-RH-E (Ver. 1.00 or later)

A	Common Items
B	N:N Network
C	Parallel Link
D	Computer Link
E	Inverter Communication
F	Non-Protocol Communication (RS/RS2 Instruction)
G	Non-Protocol Communication (FX2N-232IF)
H	Programming Communication
I	Remote Maintenance

1.4.2 For non-applicable versions (setting an alternative model)

Even software not applicable in a PLC can make programs when an alternative model is set. In this case, however, programming is enabled only in the function ranges such as instructions and program size provided in a PLC selected as the alternative model.

Model to be programmed	Model to be set	Priority: High → Low			
FX3UC Series	FX3UC	→	FX2N	→	FX2(FX)
FX3U Series	FX3U, FX3UC	→	FX2N	→	FX2(FX)
FX2NC Series	FX2NC, FX2N	→	FX2(FX)		
FX2N Series	FX2N	→	FX2(FX)		
FX1NC Series	FX1NC, FX1N	→	FX2N	→	FX2(FX)
FX1N Series	FX1N	→	FX2N	→	FX2(FX)
FX1S Series	FX1S	→	FX2(FX)		
FX0N Series	FX0N	→	FX2(FX)		
FX0S Series	FX0S	→	FX2(FX)		
FX0 Series	FX0	→	FX2(FX)		
FX2C Series	FX2C, FX2(FX)	→	FX2(FX)		
FX2(FX) Series	FX2(FX)	→	FX2(FX)		
FX1 Series	FX1				

2. System Configuration and Selection

This chapter explains the system configuration and selection of communication equipment operating in accordance with RS-422, RS-232C or USB required by FX PLCs.

2.1 System Configuration

This section explains the outline of system configuration required to use programming communication. Connect (optional) communication equipment operating in accordance with RS-422, RS-232C or USB to the built-in port in an FX PLC or the FX PLC main unit.

2.1.1 For communication equipment operating in accordance with RS-422

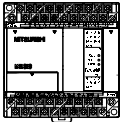
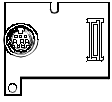
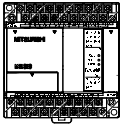
	Communication equipment operating in accordance with RS-422	FX PLC	Important point in selection	Total extension distance
1	Not required		The standard port built in a PLC is used.	30 m (98' 5")
2	 Communication board	+ 	Because the communication board can be built inside a PLC, the installation area is not changed.	30 m (98' 5")



For combinations of communication equipment for each FX Series, refer to the next section.

2.1.2 For communication equipment operating in accordance with RS-232C

1, **2** and **3** indicate the pattern types of combination of communication equipment.

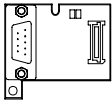
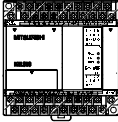
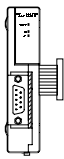
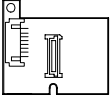
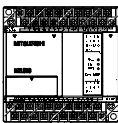
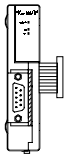
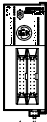
Communication equipment operating in accordance with RS-232C	FX PLC	Important point in selection	Total extension distance
<p>1</p>  <p>Communication board</p>		<p>Because the communication board can be built inside a PLC, the installation area is not changed.</p>	<p>15 m (49' 2")</p>
<p>2</p>  <p>Communication adapter</p>	 <p>Connector conversion board</p>	 <p>Attach the connector conversion board to the main unit, and then attach the communication adapter on the left side of the main unit.</p>	<p>15 m (49' 2")</p>
<p>3</p>  <p>Communication adapter</p>		<p>Attach the communication adapter on the left side of the main unit.</p>	<p>15 m (49' 2")</p>

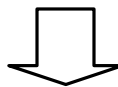

For combinations of communication equipment for each FX Series, refer to the next section.

2.1.3 For communication equipment operating in accordance with USB

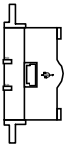
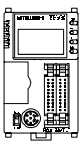
Communication equipment operating in accordance with USB	FX PLC	Important point in selection	Total extension distance
 <p>Communication board</p>		<p>Because the communication board can be built inside a PLC, the installation area is not changed.</p>	<p>5 m (16' 4")</p>

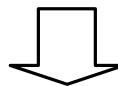



For combinations of communication equipment for each FX Series, refer to the next section.

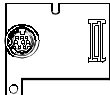
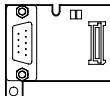
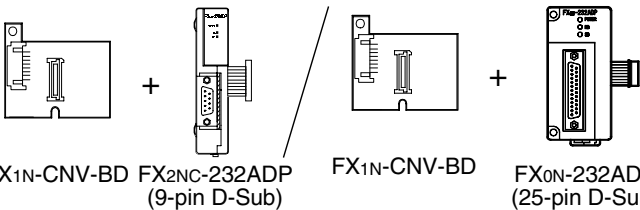

2.2 Applicable FX PLC and Communication Equipment

Select a combination of (optional) communication equipment, and put a check mark in the "Check" column. In selection, pay attention to the following:

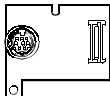
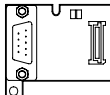
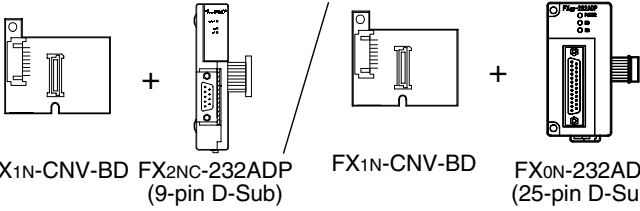
- In the table below, only the outside dimensions are different between units of shown in "232ADP/232ADP". Select either one.
- Only one unit of communication equipment can be connected.
- In the FX0, FX0s and FX0N Series, only the standard built-in port (8-pin MINI-DIN) is provided.
- In the FX1, FX2(FX), and FX2C Series, only the standard built-in port (25-pin D-Sub type) is provided.

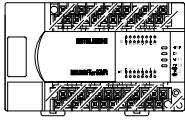

FX Series	Communication equipment (option)	Total extension distance	Check
 FX1S Standard built-in port (8-pin MINI-DIN)	 FX1N-422-BD (8-pin MINI-DIN)	30 m (98' 5")	
	 FX1N-232-BD (9-pin D-Sub)	15 m (49' 2")	
	 FX1N-CNV-BD FX2NC-232ADP (9-pin D-Sub) / FX1N-CNV-BD FX0N-232ADP (25-pin D-Sub)	15 m (49' 2")	
 FX1N Standard built-in port (8-pin MINI-DIN)	 FX1N-422-BD (8-pin MINI-DIN)	30 m (98' 5")	
	 FX1N-232-BD (9-pin D-Sub)	15 m (49' 2")	
	 FX1N-CNV-BD FX2NC-232ADP (9-pin D-Sub) / FX1N-CNV-BD FX0N-232ADP (25-pin D-Sub)	15 m (49' 2")	

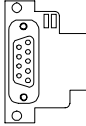
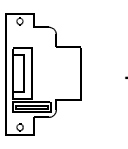
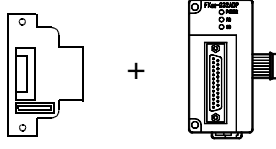
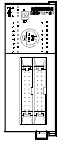
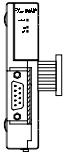
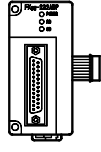
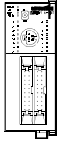
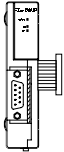
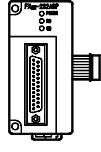
A	Common Items
B	N:N Network
C	Parallel Link
D	Computer Link
E	Inverter Communication
F	Non-Protocol Communication (RS/RS2 Instruction)
G	Non-Protocol Communication (FX2N-232IF)
H	Programming Communication
I	Remote Maintenance

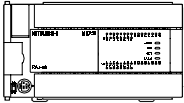
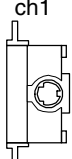
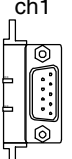
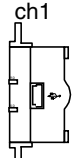
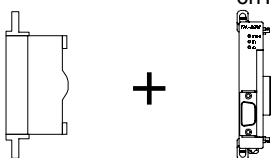
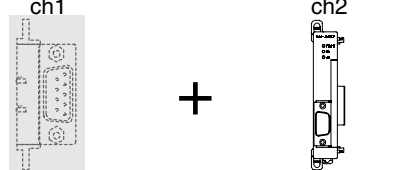
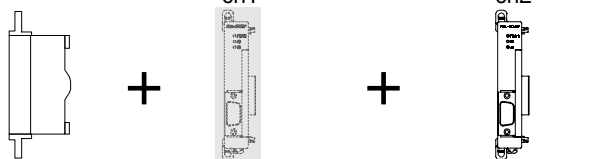
FX Series	Communication equipment (option)	Total extension distance	Check
 <p>FX2N Standard built-in port (8-pin MINI-DIN)</p>	 <p>FX2N-422-BD (8-pin MINI-DIN)</p>	30 m (98' 5")	
	 <p>FX2N-232-BD (9-pin D-Sub)</p>	15 m (49' 2")	
	 <p>FX2N-CNV-BD FX2NC-232ADP (9-pin D-Sub)</p>  <p>FX2N-CNV-BD FX0N-232ADP (25-pin D-Sub)</p>	15 m (49' 2")	
 <p>FX1NC Standard built-in port (8-pin MINI-DIN)</p>	 <p>FX2NC-232ADP (9-pin D-Sub)</p>  <p>FX0N-232ADP (25-pin D-Sub)</p>	15 m (49' 2")	
 <p>FX2NC Standard built-in port (8-pin MINI-DIN)</p>	 <p>FX2NC-232ADP (9-pin D-Sub)</p>  <p>FX0N-232ADP (25-pin D-Sub)</p>	15 m (49' 2")	

FX Series	Communication equipment (option)	Total extension distance	Check
 <p>FX3U Standard built-in port (8-pin MINI-DIN)</p>	When using channel 1 (ch 1)		
	 <p>ch1 FX3U-422-BD (8-pin MINI-DIN)</p>	30 m (98' 5")	
	 <p>ch1 FX3U-232-BD (9-pin D-Sub, male)</p>	15 m (49' 2")	
	 <p>ch1 FX3U-USB-BD (MINI-USB B)</p>	5 m (16' 4")	
	 <p>FX3U-CNV-BD + FX3U-232ADP (9-pin D-Sub, male)</p>	15 m (49' 2")	
	When using channel 2 (ch 2)		
	 <p>ch1 + ch2 FX3U-□-BD (One is put in □ among 232, 422, 485 and USB) + FX3U-232ADP (9-pin D-Sub, male)</p>	15 m (49' 2")	
	 <p>FX3U-CNV-BD + ch1 + ch2 FX3U-□-ADP (One is put in □ among 232 and 485) + FX3U-232ADP (9-pin D-Sub, male)</p>	15 m (49' 2")	

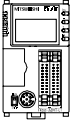
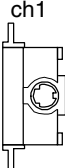
A	Common Items
B	N:N Network
C	Parallel Link
D	Computer Link
E	Inverter Communication
F	Non-Protocol Communication (RS/RS2 Instruction)
G	Non-Protocol Communication (FX2N-232IF)
H	Programming Communication
I	Remote Maintenance

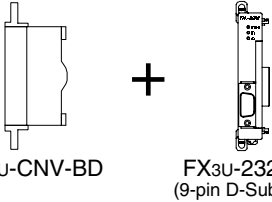
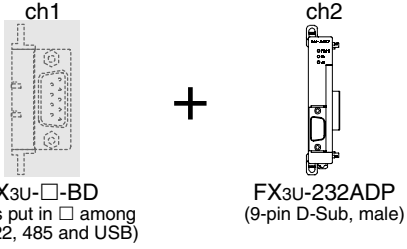
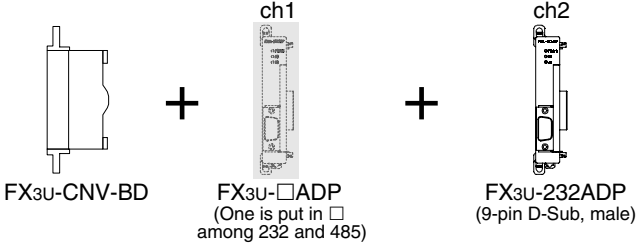
FX Series	Communication equipment (option)	Total extension distance	Check
 <p>FX3UC Standard built-in port (8-pin MINI-DIN)</p>	When using channel 1 (ch 1)		
	 <p>ch1 FX3U-422-BD (8-pin MINI-DIN)</p>	30 m (98' 5")	
	 <p>ch1 FX3U-232-BD (9-pin D-Sub, male)</p>	15 m (49' 2")	
	 <p>ch1 FX3U-USB-BD (MINI-USB B)</p>	5 m (16' 4")	
	 <p>FX3U-CNV-BD + FX3U-232ADP (9-pin D-Sub, male)</p>	15 m (49' 2")	
	When using channel 2 (ch 2)		
	 <p>ch1 + ch2 FX3U-□-BD (One is put in □ among 232, 422, 485 and USB) + FX3U-232ADP (9-pin D-Sub, male)</p>	15 m (49' 2")	
	 <p>FX3U-CNV-BD + ch1 + ch2 FX3U-□-ADP (One is put in □ among 232 and 485) + FX3U-232ADP (9-pin D-Sub, male)</p>	15 m (49' 2")	

2.3 Caution on Selection

Some cautions should be observed when using a programming tool in optional FX PLC communication equipment.
 Consider the following contents in selection.

2.3.1 When using 422BD

1. Current consumption at 5V DC of the expansion board

When the 422BD is attached to a PLC, it consumes the following current:

- 1) For FX3U and FX3UC PLCs
 The FX3U-422-BD consumes 20 mA at 5V DC from an FX3U/FX3UC PLC.
- 2) For FX2N PLCs
 The FX2N-422-BD consumes 60 mA at 5V DC from an FX2N PLC.

2. Current consumption of the special extension equipment and peripheral equipment

Make sure that the current consumption at 5V DC including the 422BD described above, special extension equipment, and peripheral equipment shown below does not exceed the power capacity at 5V DC in an FX2N/FX3U/FX3UC PLC.

Peripheral equipment	Connection cable	Current consumption at 5V DC*1
FX-20P(-E)	FX-20P-CAB0 or FX20P-CAB + FX-20P-CADP	180 mA
FX-10P(-E)		120 mA
Personal computer (for programming)	<F2-232CAB (for 25-pin D-Sub), F2-232CAB-1 (for 9-pin D-Sub) or F2-232CAB-2 (for 14-pin half-pitch)> + FX-232AW(C) + FX-422CAB0	220 mA
	<F2-232CAB (for 25-pin D-Sub), F2-232CAB-1 (for 9-pin D-Sub) or F2-232CAB-2 (for 14-pin half-pitch)> + FX-232AWC-H + FX-422CAB0	120 mA
	USB cable (for connecting personal computer: A plug, male type) (for connecting FX-USB-AW: MINI B plug, male type) + FX-USB-AW	15 mA
FX-10DU(-E)	FX-20P-CAB0 or FX20P-CAB + FX-20P-CADP	220 mA
FX-20DU(-E)	FX-20DU-CAB0	180 mA
FX-10DM(-E)	FX-20P-CAB0 or FX20P-CAB + FX-20P-CADP	220 mA
FX-25DU(-E), FX-30DU(-B)(-E), FX-40DU(-B)(-ES), FX-40DU-TK(B)(-E), FX-50DU-TK(S)(-E), and ET-50 Series	FX-50DU-CAB0(-1M, -10M, -20M, -30M)	0 mA
	FX-40DU-CAB(-10M, -20M, -30M) + FX-422AW0	160 mA
F940GOT-SWD(LWD)(-E), F930GOT-BWD(-E), ET-940 Series F930GOT-BBD-K(-E), and F920GOT-BBD-K	FX-50DU-CAB0(-1M, -10M, -20M, -30M, L)	0 mA
F940 Handy GOT (RH type)	F9GT-H(RH)CAB2-150 + F9GT-H(RH)CAB-3M(-10M) or F9GT-HCAB-3M(-10M) + F9GT-HCNB + FX-50DU-CAB0(-1M)	0 mA
F920GOT-BBD5-K	FX-50DU-CAB0(-1M)	220 mA
F920 Handy GOT RH type	F9GT-HCAB2-150, F9GT-HCAB-3M(-10M)	0 mA
GOT-A900 Series (CPU direct connection type)	FX9GT-CAB0(-150,-10M)	0 mA
GOT1000 Series (CPU direct connection type)	GT01-C□R4-8P ("10", "30", "100", "200", or "300" is put in □.)	0 mA

*1. The power consumption of the FX3U-422-BD and FX2N-422-BD is not included.

3. Connection of the FX-2PIF

The FX-2PIF cannot be connected to the 422BD.
 Connect it to the standard port.

2.3.2 When using 232BD or 232ADP

When the 232BD or 232ADP is attached to a PLC, it consumes the current shown in the table below. Make sure that the power capacity of 5V DC in the FX2N/FX3U/FX1NC/FX2NC/FX3UC PLC is not exceeded.

✓: Attachable, —: Not attachable

Model name	Power consumption at 5 VDC	FX2N	FX3U	FX1NC	FX2NC	FX3UC
FX3U-232-BD	20 mA	—	✓	—	—	✓
FX2N-232-BD	20 mA	✓	—	—	—	—
FX3U-232ADP	30 mA	—	✓	—	—	✓
FX2NC-232ADP	100 mA	✓	—	✓	✓	—
FX0N-232ADP	200 mA	✓	—	✓	✓	—

2.3.3 Other cautions

1. For FX1S, FX1N, FX1NC and FX2N (whose version is before Ver. 2.00) PLCs

- 1) Verify that the communication format is in the initial status (D8120 = K0).
 Check using the peripheral equipment how the communication is set using parameters.
 If the communication is set so that non-protocol procedure (RS instruction) or a dedicated protocol is used, clear the setting to "0" using the peripheral equipment.
- 2) If RS instruction is used in a program, delete it, turn OFF the PLC power, and then turn it ON again.

2. For FX2N (whose version is Ver. 2.00 or later) and FX2NC (whose version is before Ver. 3.00) PLCs

- 1) Verify that the communication format is in the initial status (D8120 = K0).
 Check using the peripheral equipment how the communication is set using parameters.
 If the communication is set so that non-protocol procedure (RS instruction) or a dedicated protocol is used, clear the setting to "0" using the peripheral equipment.
- 2) If RS instruction is used in a program, do not execute it. If it is executed, the PLC operates according to RS instruction.

3. For FX2N (whose version is Ver. 3.00 or later) and FX2NC (whose version is Ver. 3.00 or later) PLCs

- 1) Verify that the communication format is in the initial status (D8120 = K0).
 Check using the peripheral equipment how the communication is set using parameters.
 If the communication is set so that non-protocol procedure (RS instruction) or a dedicated protocol is used, clear the setting to "0" using the peripheral equipment.
- 2) If RS instruction is used in a program, do not execute it. If it is executed, the PLC operates according to RS instruction.
- 3) If EXTR instruction is used in a program, delete it, turn OFF the PLC power, and then turn it ON again.

4. For FX3U and FX3UC PLCs

- 1) Verify that the communication format in a communication port used in programming communication is set correctly (D8120, D8400, D8420 = K0).
 Check using the peripheral equipment whether the communication is set correctly using parameters.
- 2) Verify that RS or RS2 instruction is not executed in a program in a communication port used in programming communication.
 Do not execute RS and RS2 instructions.
- 3) If an inverter communication instruction is used in a program in a communication port used in programming communication, delete it, turn OFF the PLC power, and then turn it ON again.

3. Selecting Connection Cables

This chapter explains the connection cable selection method.

3.1 Connection Procedure

1 Checking the connector shape

Check the shape (male or female, etc.) of the connector of a connected programming tool (such as personal computer) and the shape of the connector of a PLC, and verify that connection is possible.

2 Connecting the cable connector to the programming tool

Check the shape of the connector of a cable for the programming tool, and connect the cable correctly.

3 Connecting the cable connector to the PLC

Check the connector of a cable for the PLC, and connect the cable correctly. The cable connector has one of the following shapes:

- 8-pin MINI-DIN, male
- 25-pin D-Sub, male
- 9-pin D-Sub, female
- 5-pin MINI-USB B plug, female

1. Selecting a connection cable

According to the combination of the connected programming tool and PLC (communication equipment), select a proper cable.

A

Common Items

B

N:N Network

C

Parallel Link

D

Computer Link

E

Inverter Communication

F

Non-Protocol Communication (RS/RS2 Instruction)

G

Non-Protocol Communication (FX2N-232IF)





H

Programming Communication

I

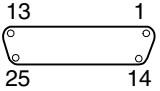

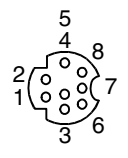
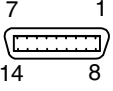
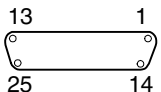
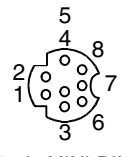
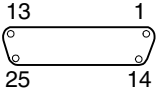
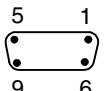

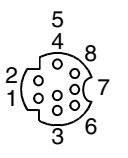
Remote Maintenance

3.2 Connector Shape in Each Product

Model name (series)	Connector shape	Model name (series)	Connector shape
PLC		Personal computer	
FX1, FX2(FX) and FX2C PLCs	 <p>25-pin D-Sub, female</p>	PC-AT compatible machine - DOS/V personal computer - Windows personal computer	 <p>9-pin D-Sub, male</p>
FX0, FX0S, FX0N, FX1S, FX1N, FX2N, FX3U, FX1NC, FX2NC and FX3UC PLCs	 <p>8-pin MINI-DIN, female</p>	PC-9800 Series (NEC) - Notebook type personal computer	 <p>14-pin Half-pitch, female</p>
PLC (communication equipment)		PC-9800 Series (NEC) - Desktop type personal computer	 <p>25-pin D-Sub, female</p>
FX1N-422-BD FX2N-422-BD FX3U-422-BD	 <p>8-pin MINI-DIN, female</p>		
FX0N-232ADP	 <p>25-pin D-Sub, female</p>		
FX1N-232-BD FX2N-232-BD FX3U-232-BD FX2NC-232ADP FX3U-232ADP	 <p>9-pin D-Sub, male</p>		
FX3U-USB-BD	 <p>5-pin MINI-USB B plug, female</p>		
Handy programming panel			
FX-10P(-E), FX-10P-SET0(-E), FX-20P(-E), FX-20P-SET0(-E)	 <p>8-pin MINI-DIN, female</p>		

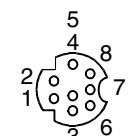
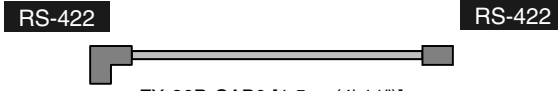
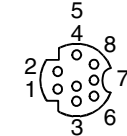
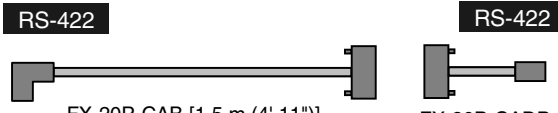
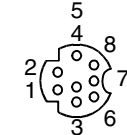

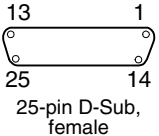
3.3 Combinations of Connection Cables

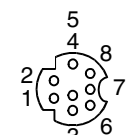
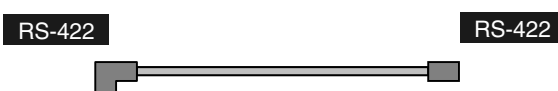
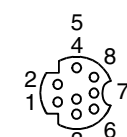
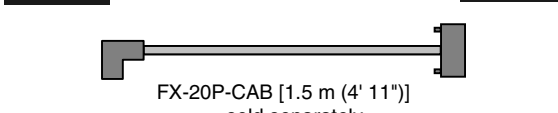
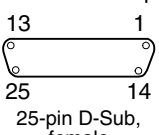
3.3.1 Handy programming panel

Programming tool connector shape	Cable combination	PLC connector shape	Cable length
 <p>FX-10P(-E) FX-20P(-E)</p>  <p>8-pin MINI-DIN, female</p>	 <p>RS-422</p> <p>FX-20P-CAB0 [1.5 m (4' 11")] ... sold separately</p>	Standard built-in port FX1N-422-BD FX2N-422-BD FX3U-422-BD  <p>8-pin MINI-DIN, female</p>	1.5 m (4' 11")
	 <p>RS-422</p> <p>FX-20P-CAB [1.5 m (4' 11")] ... supplied with</p> <p>RS-422</p> <p>FX-20P-CADP [0.3 m (0' 11")] ... sold separately</p>	Standard built-in port  <p>8-pin MINI-DIN, female</p>	1.8 m (5' 10")
	 <p>RS-422</p> <p>FX-20P-CAB [1.5 m (4' 11")] ... supplied with</p>	Standard built-in port  <p>25-pin D-Sub, female</p>	1.5 m (4' 11")
 <p>FX-10P-SET0(-E) FX-20P-SET0(-E)</p>  <p>8-pin MINI-DIN, female</p>	 <p>RS-422</p> <p>FX-20P-CAB0 [1.5 m (4' 11")] ... supplied with</p>	Standard built-in port FX1N-422-BD FX2N-422-BD FX3U-422-BD  <p>8-pin MINI-DIN, female</p>	1.5 m (4' 11")
	 <p>RS-422</p> <p>FX-20P-CAB [1.5 m (4' 11")] ... sold separately</p>	Standard built-in port  <p>25-pin D-Sub, female</p>	1.5 m (4' 11")

A	Common Items
B	N:N Network
C	Parallel Link
D	Computer Link
E	Inverter Communication
F	Non-Protocol Communication (RS/RS2 Instruction)
G	Non-Protocol Communication (FX2N-232IF)
H	Programming Communication
I	Remote Maintenance

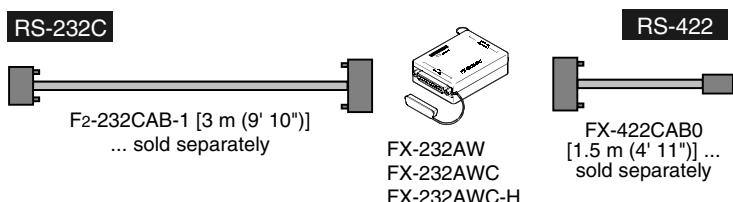
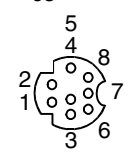
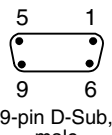
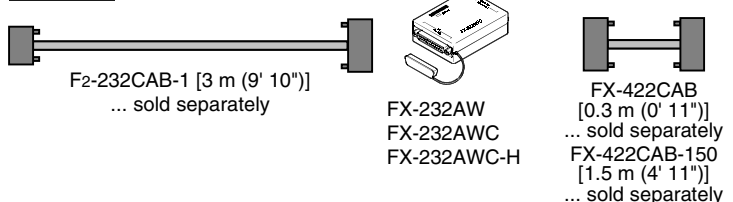
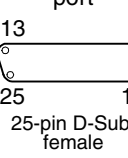
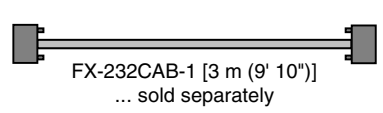
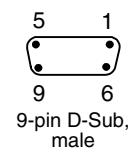
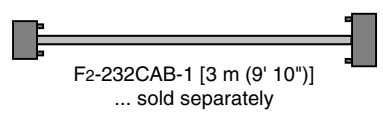
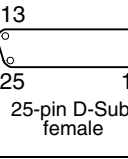
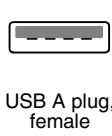
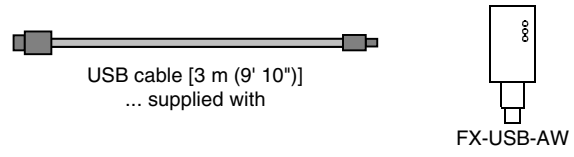
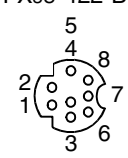
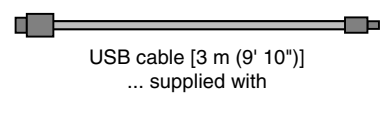
3.3.2 Personal computer

Programming tool connector shape	Cable combination	PLC connector shape	Cable length
	<p>RS-232C</p>  <p>F2-232CAB-1 [3 m (9' 10")] ... sold separately</p> <p>FX-232AW FX-232AWC FX-232AWC-H</p> <p>RS-422</p> <p>FX-422CAB0 [1.5 m (4' 11")] ... sold separately</p>	<p>Standard built-in port</p> <p>FX1N-422-BD FX2N-422-BD FX3U-422-BD</p>  <p>8-pin MINI-DIN, female</p>	4.5 m (14' 9")
<p>PC-AT compatible machine</p> <ul style="list-style-type: none"> - DOS/V personal computer - Windows personal computer  <p>9-pin D-Sub, male</p>	<p>RS-232C</p>  <p>F2-232CAB-1 [3 m (9' 10")] ... sold separately</p> <p>FX-232AW FX-232AWC FX-232AWC-H</p> <p>RS-422</p> <p>FX-422CAB [0.3 m (0' 11")] ... sold separately</p> <p>FX-422CAB-150 [1.5 m (4' 11")] ... sold separately</p>	<p>Standard built-in port</p>  <p>25-pin D-Sub, female</p>	<p>3.3 m (10' 9")</p> <p>4.5 m (14' 9")</p>
	<p>RS-232C</p>  <p>FX-232CAB-1 [3 m (9' 10")] ... sold separately</p> <p>RS-232C</p>	<p>FX1N-232-BD FX2N-232-BD FX3U-232-BD FX2NC-232ADP FX3U-232ADP</p>  <p>9-pin D-Sub, male</p>	3 m (9' 10")
	<p>RS-232C</p>  <p>F2-232CAB-1 [3 m (9' 10")] ... sold separately</p> <p>RS-232C</p>	<p>FX0N-232ADP</p>  <p>25-pin D-Sub, female</p>	3 m (9' 10")
<p>PC-AT compatible machine</p> <ul style="list-style-type: none"> - Windows personal computer  <p>USB A plug, female</p>	<p>USB</p>  <p>USB cable [3 m (9' 10")] ... supplied with</p> <p>FX-USB-AW</p> <p>RS-422</p>	<p>Standard built-in port</p> <p>FX1N-422-BD FX2N-422-BD FX3U-422-BD</p>  <p>8-pin MINI-DIN, female</p>	3 m (9' 10")
	<p>USB</p>  <p>USB cable [3 m (9' 10")] ... supplied with</p> <p>USB</p>	<p>FX3U-USB-BD</p>  <p>5-pin MINI-USB B plug, female</p>	5 m (16' 4")

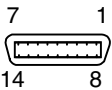
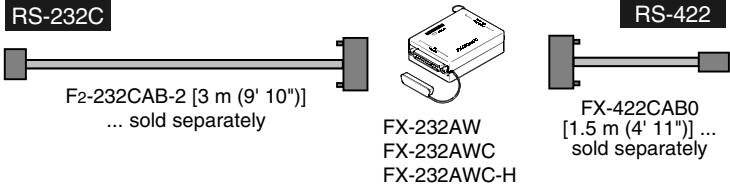
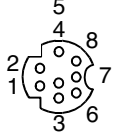
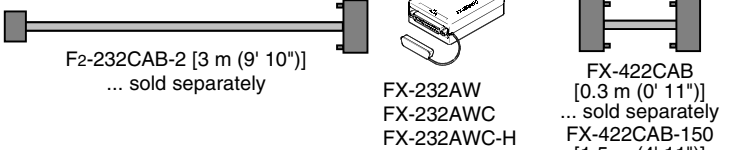
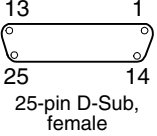
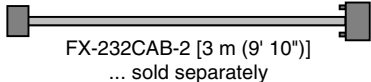
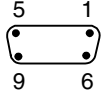
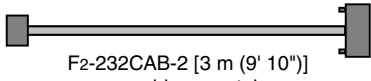
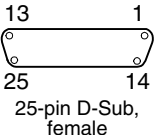
Programming tool connector shape	Cable combination	PLC connector shape	Cable length
PC-9800 Series (NEC) - Notebook type personal computer  7 1 14 8 14-pin Half-pitch, female	 <p>RS-232C F2-232CAB-2 [3 m (9' 10")] ... sold separately</p> <p>FX-232AW FX-232AWC FX-232AWC-H</p> <p>RS-422 FX-422CAB0 [1.5 m (4' 11")] ... sold separately</p>	Standard built-in port FX1N-422-BD FX2N-422-BD FX3U-422-BD  8-pin MINI-DIN, female	4.5 m (14' 9")
	 <p>RS-232C F2-232CAB-2 [3 m (9' 10")] ... sold separately</p> <p>FX-232AW FX-232AWC FX-232AWC-H</p> <p>RS-422 FX-422CAB [0.3 m (0' 11")] ... sold separately FX-422CAB-150 [1.5 m (4' 11")] ... sold separately</p>	Standard built-in port  25-pin D-Sub, female	3.3 m (10' 9") 4.5 m (14' 9")
	 <p>RS-232C FX-232CAB-2 [3 m (9' 10")] ... sold separately</p> <p>RS-232C</p>	FX1N-232-BD FX2N-232-BD FX3U-232-BD FX2NC-232ADP FX3U-232ADP  9-pin D-Sub, male	3 m (9' 10")
	 <p>RS-232C F2-232CAB-2 [3 m (9' 10")] ... sold separately</p> <p>RS-232C</p>	FX0N-232ADP  25-pin D-Sub, female	3 m (9' 10")

A	Common Items
B	N:N Network
C	Parallel Link
D	Computer Link
E	Inverter Communication
F	Non-Protocol Communication (RS/RS2 Instruction)
G	Non-Protocol Communication (FX2N-232IF)
H	Programming Communication
I	Remote Maintenance

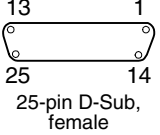
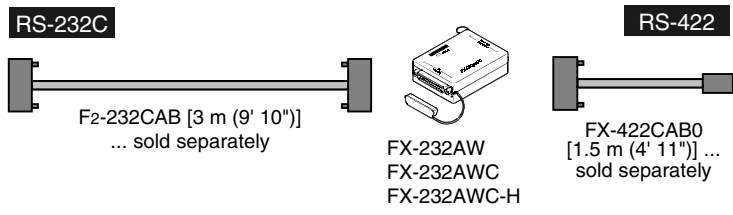
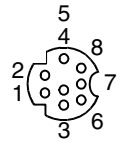
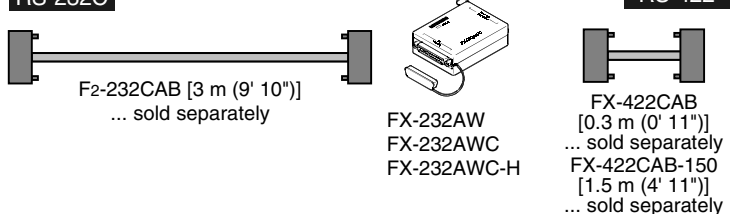
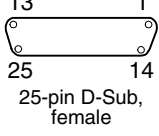
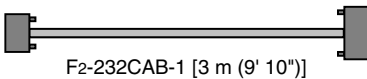
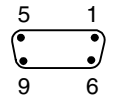
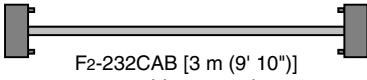
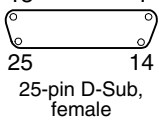
Programming tool connector shape	Cable combination	PLC connector shape	Cable length
PC-9800 Series (NEC) - Desktop type personal computer  25-pin D-Sub, female	 <p>RS-232C F2-232CAB [3 m (9' 10")] ... sold separately</p> <p>FX-232AW FX-232AWC FX-232AWC-H</p> <p>RS-422 FX-422CAB0 [1.5 m (4' 11")] ... sold separately</p>	Standard built-in port FX1N-422-BD FX2N-422-BD FX3U-422-BD  8-pin MINI-DIN, female	4.5 m (14' 9")
	 <p>RS-232C F2-232CAB [3 m (9' 10")] ... sold separately</p> <p>FX-232AW FX-232AWC FX-232AWC-H</p> <p>RS-422 FX-422CAB [0.3 m (0' 11")] ... sold separately FX-422CAB-150 [1.5 m (4' 11")] ... sold separately</p>	Standard built-in port  25-pin D-Sub, female	3.3 m (10' 9") 4.5 m (14' 9")
	 <p>RS-232C F2-232CAB-1 [3 m (9' 10")] ... sold separately</p> <p>RS-232C</p>	FX1N-232-BD FX2N-232-BD FX3U-232-BD FX2NC-232ADP FX3U-232ADP  9-pin D-Sub, male	3 m (9' 10")
	 <p>RS-232C F2-232CAB [3 m (9' 10")] ... sold separately</p> <p>RS-232C</p>	FX0N-232ADP  25-pin D-Sub, female	3 m (9' 10")





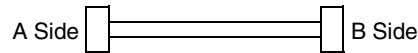

4. Connection Cables and Interfaces

4.1 Simplified Tables

4.1.1 Cable connector shape correspondence table

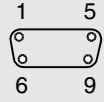
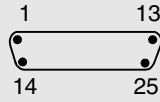
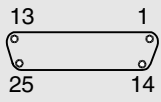
From the shape of connectors at both ends of a cable, the cable model name can be known.



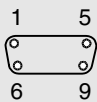
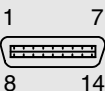
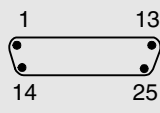

B Side					
A Side	8-pin MINI-DIN, male	5-pin MINI-USB B plug, male	9-pin D-Sub, female	25-pin D-Sub, male	25-pin D-Sub, female
	FX-20P-CAB0	—	—	FX-20P-CAB FX-422CAB0	FX-20P-CADP
	FX-USB-AW (converter)	—	—	—	—
	—	USB cable Provided as an accessory of FX- USB-AW and FX3U-USB-BD	—	—	—
	—	—	FX-232CAB-1	F2-232CAB-1	—
	—	—	FX-232CAB-2	F2-232CAB-2	—
	—	—	F2-232CAB-1	F2-232CAB	—

A	Common Items
B	N:N Network
C	Parallel Link
D	Computer Link
E	Inverter Communication
F	Non-Protocol Communication (RS/RS2 Instruction)
G	Non-Protocol Communication (FX2N-232IF)
H	Programming Communication
I	Remote Maintenance

4.1.2 Cable combination simplified table

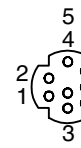
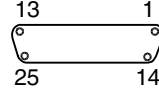
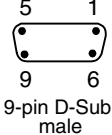
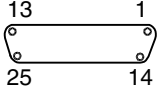
From the shape of the programming tool connector and PLC connector, combinations of the cable, converter and communication equipment can be checked.

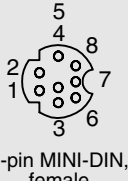
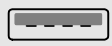
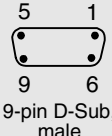
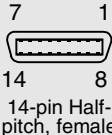
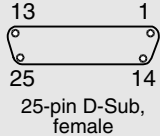
Interface	RS-422		RS-232C		USB	
Standard port	FX0,FX0S,FX0N FX1S,FX1N,FX2N FX1NC,FX2NC FX3U,FX3UC	FX1,FX2(FX) FX2C,A,QnA	—	—	—	
Communication equipment	FX1N-422-BD FX2N-422-BD FX3U-422-BD	—	FX1N-232-BD FX2N-232-BD FX3U-232-BD FX2NC-232ADP FX3U-232ADP	FX0N-232ADP	FX3U-USB-BD	
Connector in PLC						
	 8-pin MINI-DIN, female	 25-pin D-Sub, female	 9-pin D-Sub, male	 25-pin D-Sub, female	 5-pin MINI-USB B plug, female	
Connector in programming tool	 8-pin MINI-DIN, female	FX-20P-CAB0 or FX-20P-CAB + FX-20P-CADP	FX-20P-CAB	—	—	
	 USB A plug, female	FX-USB-AW + USB cable (included)	—	—	USB cable (included)	
	 9-pin D-Sub, male	F2-232CAB-1 + FX-232AW FX-232AWC FX-232AWC-H + FX-422CAB0	F2-232CAB-1 + FX-232AW FX-232AWC FX-232AWC-H + FX-422CAB or FX-422CAB-150	FX-232CAB-1	F2-232CAB-1	—
	 14-pin Half-pitch, female	F2-232CAB-2 + FX-232AW FX-232AWC FX-232AWC-H + FX-422CAB0	F2-232CAB-2 + FX-232AW FX-232AWC FX-232AWC-H + FX-422CAB or FX-422CAB-150	FX-232CAB-2	F2-232CAB-2	—
	 25-pin D-Sub, female	F2-232CAB + FX-232AW FX-232AWC FX-232AWC-H + FX-422CAB0	F2-232CAB + FX-232AW FX-232AWC FX-232AWC-H + FX-422CAB or FX-422CAB-150	F2-232CAB-1	F2-232CAB	—

4.2 Cable Connection Diagrams

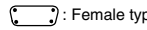
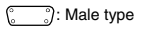

This section explains cable connection diagrams required for connection.

4.2.1 Personal computer connection cable - No. A

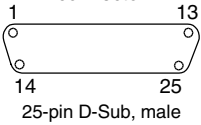
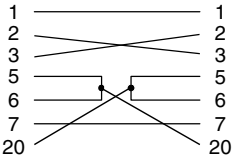
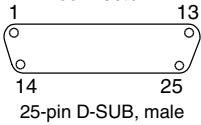
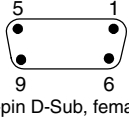
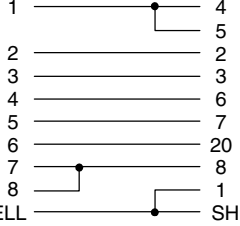
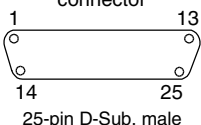
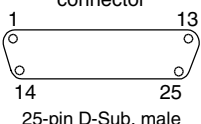
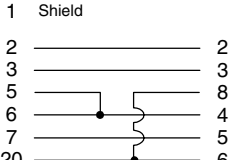
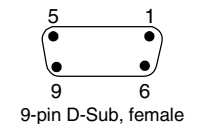
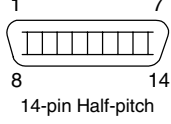
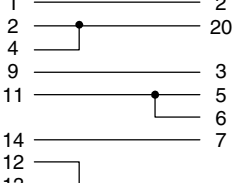
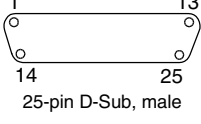
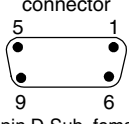
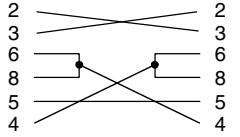
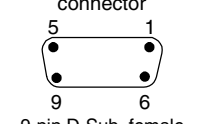
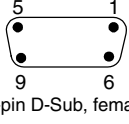
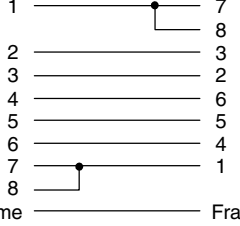
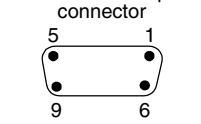
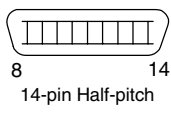
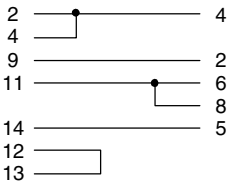
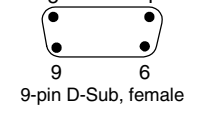
 : Female type  : Male type The connector shape indicates the engagement surface.

No.	Cable model name	Application	Connection diagram	Application
A-1	F2-232CAB	RS-232C connection Personal computer connector  25-pin D-Sub, male		Communication port connector  25-pin D-SUB, male
A-2	Commercial cable* ¹ Reverse (cross) type	RS-232C connection Personal computer connector  9-pin D-Sub, female * ¹ Interlink supporting cables are not applicable.		Communication port connector  25-pin D-Sub, male
A-3	F2-232CAB-1	RS-232C connection Personal computer connector  25-pin D-Sub, male		Communication port connector  9-pin D-Sub, female
A-4	F2-232CAB-2	RS-232C connection Personal computer connector  14-pin Half-pitch		Communication port connector  25-pin D-Sub, male
A-5	FX-232CAB-1	RS-232C connection Personal computer connector  9-pin D-Sub, female		Communication port connector  9-pin D-Sub, female
A-6	Commercial cable* ¹ Reverse (cross) type	RS-232C connection Personal computer connector  9-pin D-Sub, female * ¹ Interlink supporting cables are not applicable.		Communication port connector  9-pin D-Sub, female
A-7	FX-232CAB-2	RS-232C connection Personal computer connector  14-pin Half-pitch		Communication port connector  9-pin D-Sub, female

A	Common Items
B	N:N Network
C	Parallel Link
D	Computer Link
E	Inverter Communication
F	Non-Protocol Communication (RS/RS2 Instruction)
G	Non-Protocol Communication (FX2N-232IF)
H	Programming Communication
I	Remote Maintenance

 : Female type  : Male type The connector shape indicates the engagement surface.

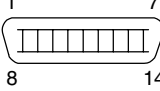
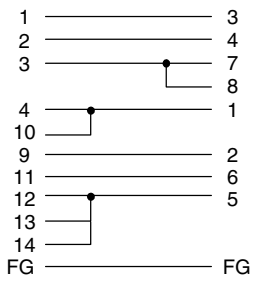
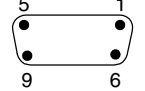
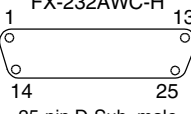
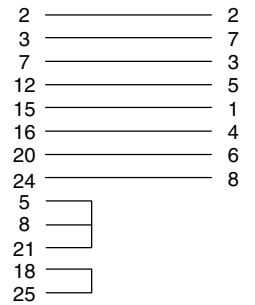
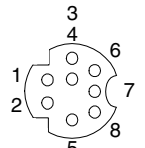
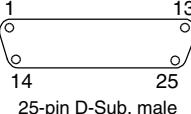
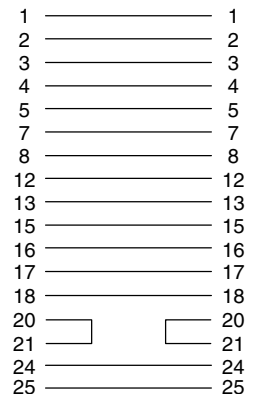
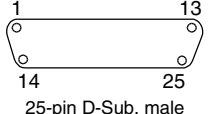
No.	Cable model name	Application	Connection diagram	Application
A-8	<div style="border: 1px solid black; padding: 2px; display: inline-block;">RS-232C connection</div> Commercial cable*1 Reverse (cross) type	Personal computer connector  14-pin Half-pitch		Communication port connector  9-pin D-Sub, female
*1 Interlink supporting cables are not applicable.				
A-9	<div style="border: 1px solid black; padding: 2px; display: inline-block;">RS-422 connection</div> FX-422CAB0	Converter FX-232AW,FX-232AWC, FX-232AWC-H  25-pin D-Sub, male		 8-pin MINI-DIN, male
A-10	<div style="border: 1px solid black; padding: 2px; display: inline-block;">RS-422 connection</div> FX-422CAB [0.3 m (0' 11")] FX-422CAB-150 [1.5 m (4' 11")]	Converter FX-232AW,FX-232AWC, FX-232AWC-H  25-pin D-Sub, male		 25-pin D-Sub, male

4.2.2 Connector conversion cable (commercial product) - No. B

: Female type
 : Male type
 The connector shape indicates the engagement surface.

No.	Cable model name	Application	Connection diagram	Application
B-1	<div style="border: 1px solid black; padding: 2px; display: inline-block;">RS-232C connection</div> Connector conversion cable (normal type)	 9-pin D-Sub, female	 1 ————— 8 2 ————— 3 3 ————— 2 4 ————— 20 5 ————— 7 6 ————— 6 7 ————— 4 8 ————— 5 9 ————— 22 FG ————— FG	 25-pin D-Sub, male
B-2	<div style="border: 1px solid black; padding: 2px; display: inline-block;">RS-232C connection</div> Connector conversion cable (normal type)	 14-pin Half-pitch	 12 ———— 1 13 ———— 14 9 ————— 2 1 ————— 3 10 ———— 4 4 ————— 5 2 ————— 6 2 ————— 7 14 ———— 11 14 ———— 13 3 ————— 8 6 ————— 15 5 ————— 17 11 ———— 20 7 ————— 22 8 ————— 24 SHELL ——— SHELL	 25-pin D-Sub, male
B-3	<div style="border: 1px solid black; padding: 2px; display: inline-block;">RS-422 connection</div> FX-20P-CADP	 25-pin D-Sub, female	 2 ————— 2 3 ————— 7 7 ————— 3 12 ———— 5 15 ———— 1 16 ———— 4 20 ———— 6 24 ———— 8 5 ———— 8 ———— 21 ———— 18 ————	 8-pin MINI-DIN, male

4.2.3 FX-10P/FX-20P connection cable - No. C

: Female type
 : Male type
 The connector shape indicates the engagement surface.

No.	Cable model name	Application	Connection diagram	Application
C-1	<div style="border: 1px solid black; padding: 2px; display: inline-block;">RS-422 connection</div> FX-20P-CAB0	Programming tool 8-pin MINI-DIN, male	 1 ————— 1 2 ————— 2 3 ————— 3 4 ————— 4 5 ————— 5 6 ————— 6 7 ————— 7 8 ————— 8	Communication port connector 8-pin MINI-DIN, male
C-2	<div style="border: 1px solid black; padding: 2px; display: inline-block;">RS-422 connection</div> FX-20P-CAB	Programming tool 8-pin MINI-DIN, male	 2 ————— 2 3 ————— 7 7 ————— 3 5 ————— 12 1 ————— 15 4 ————— 16 6 ————— 20 8 ————— 24 4 ———— 8 ———— 21 ———— 13 ———— 17 ————	 25-pin D-Sub, male

A Common Items
B N:N Network
C Parallel Link
D Computer Link
E Inverter Communication
F Non-Protocol Communication (RS/RS2 Instruction)
G Non-Protocol Communication (FX2N-232IF)
H Programming Communication
I Remote Maintenance

5. Communication Setting (Initialization) in FX Programmable Controller

This chapter explains the communication setting method for executing programming communication using optional communication equipment operating in accordance with RS-422 or RS-232C. The setting described here is not required when the standard built-in port is used. When executing programming communication on ch2 in an FX3U/FX3UC PLC, check the contents of D8420 using the procedure described below.

5.1 Check Procedure

1 Monitoring D8120

Turn ON the PLC power while it is in STOP mode, and monitor D8120.

1. **When the value of D8120 is "0"**
The communication setting is not provided.
2. **When the value of D8120 is any value other than "0"**
The communication setting is provided.

2 Checking absence/presence of the parameter setting

Check absence/presence using the GX Developer or FXGP/WIN.

- 1) GX Developer operating procedure (For details, refer to Section 5.2.)
- 2) FXGP/WIN operating procedure (For details, refer to Section 5.3.)

3 Checking absence/presence of sequence program setting

Verify that or not an instruction for writing a value to D8120 is programmed.

1. When such an instruction is programmed

Program example:

Change the program as shown below, and then change the PLC mode from STOP to RUN.

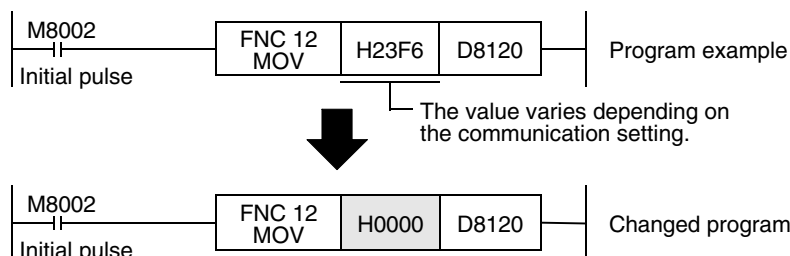

2. When such an instruction is not programmed

Proceed to the next step.

4 Monitoring D8120 again, confirming that its value is "0"

5.2 Communication Setting in Parameter Method (GX Developer)

Two software packages, GX Developer and FXGP/WIN for Windows, are applicable to the parameter method. This section explains the parameter method using GX Developer.

5.2.1 Operating procedure

This subsection explains the serial communication setting method. Suppose that GX Developer is already started up.

1 Opening the parameter setting window

Double-click [Parameter]-[PLC parameter] from the project tree.

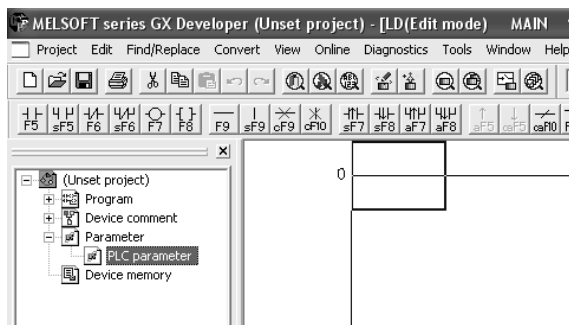

If the project tree is not displayed, select [View] - [Project data list] from the tool menu.

2 Setting the serial communication (parameters)

Click the [PLC system(2)] tab on the dialog box.

Select a channel to be used, and make sure that a check mark is not provided in the check box "Operate communication setting".

If a check mark is provided, delete it.

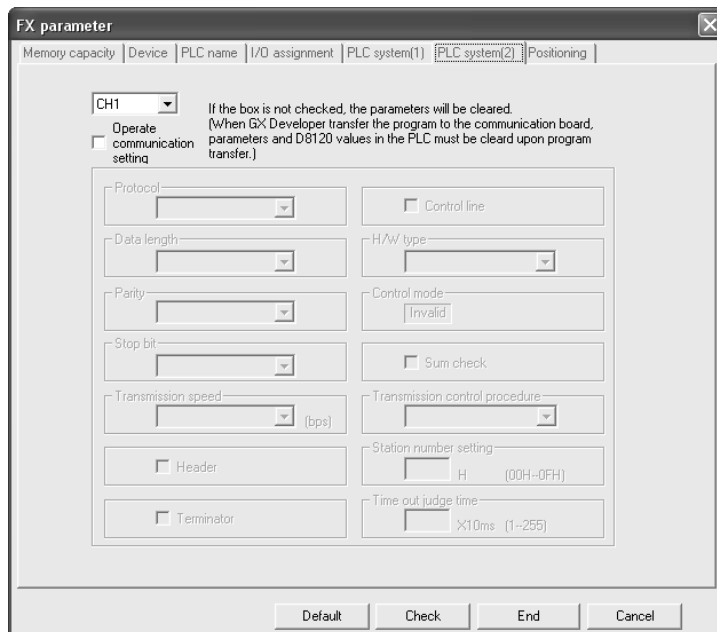

3 Writing parameters and program to the PLC

Select [Online] - [Write to PLC] from the tool menu, put a check mark (✓) to "Parameter" and "Program", and then click [Execute].

A	Common Items
B	N:N Network
C	Parallel Link
D	Computer Link
E	Inverter Communication
F	Non-Protocol Communication (RS/RS2 Instruction)
G	Non-Protocol Communication (FX2N-232IF)
H	Programming Communication
I	Remote Maintenance

5.3 Communication Setting in Parameter Method (FXGP/WIN)

Two software packages, GX Developer and FXGP/WIN for Windows, are applicable to the parameter method. This section explains the parameter method using FXGP/WIN. The ch 2 cannot be set using FXGP/WIN.

5.3.1 Operating procedure

This subsection explains the serial communication setting method. Suppose that FXGP/WIN is already started up.

1 Executing serial communication (parameter) setting

Select [Option] - [Serial setting (parameter)] from the tool menu. The following dialog appears according to absence/presence of parameter setting.

1. When there are no parameter settings

The dialog box shown below appears to indicate that there is not communication setting. Click the [No] button. In this case, the next step is not required.

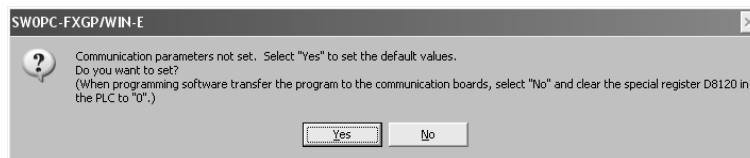

2. When there are already parameter settings

The dialog box shown below appears to indicate that there is communication setting. Click the [Clear] button to delete the communication setting from parameters. Transfer parameters to the PLC using the following step.

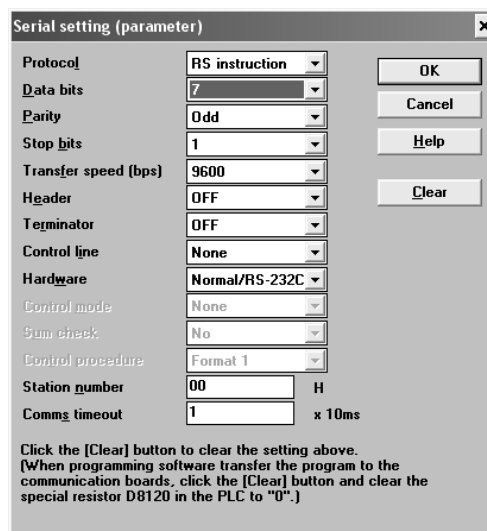

2 Writing a sequence program (parameters) to the PLC

Select [PLC] - [Transfers] - [Write] from the tool menu, and click [OK].

6. Connection Setting for Personal Computer

This chapter explains the setting method for connecting a personal computer and a PLC. Two software packages, GX Developer and FXGP/WIN for Windows, are applicable. The setting method is different between the two software packages.

6.1 Connection Setting (GX Developer)

GX Developer, Windows software for personal computers, has the following items to be set. Set each item according to the connection status.

- RS-232C or USB
- Communication port
- Transmission speed
- CPU unit (provided only in FX3U and FX3UC PLCs)
 This setting is required to use the transparent function in the GOT-F900 display unit (described later).
- Communication time check
- Number of retries

Each set item can be checked and changed on the connection destination specification window. Display the connection destination specification window using the following procedure.

1 Selecting [Online] - [Transfer Setup] from the tool menu.

The window below appears.

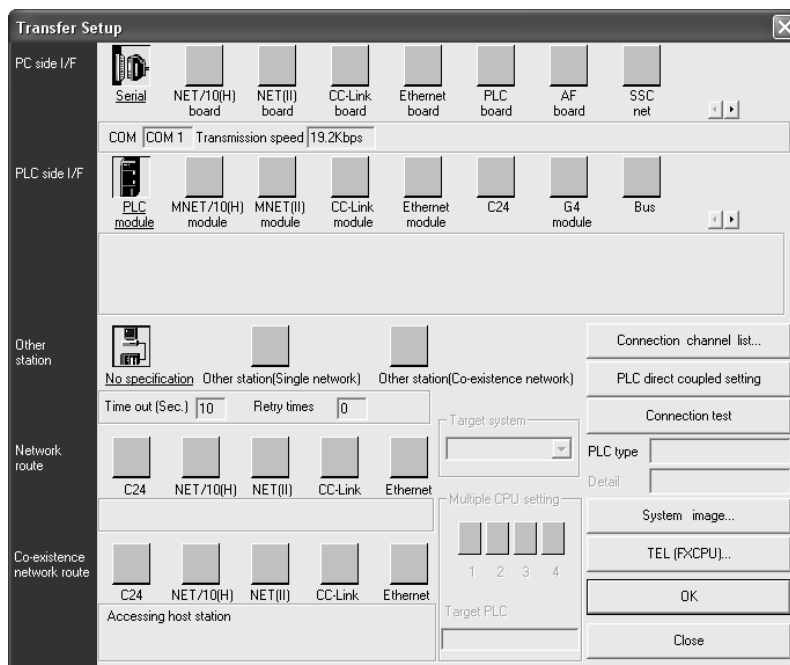

Caution

While the monitor function window is displayed, [Transfer Setup] cannot be selected.

6.1.1 Setting RS-232C or USB, communication port, and transmission speed

The setting procedures for RS-232C/USB, communication port and transmission speed are described below:

1 Displaying the "PC side I/F Serial setting" window.

Double-click the "Serial" icon  on the connection destination specification window. The window below appears.

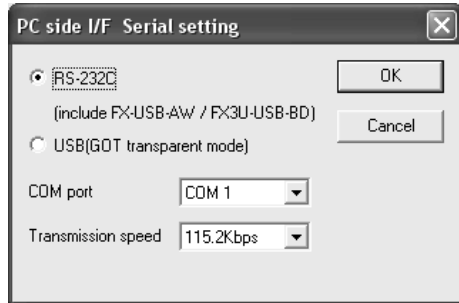

2 Selecting "RS-232C" or "USB"

1. Connection for selecting "RS-232C (include FX-USB-AW/FX3U-USB-BD)"

Connect the PLC to the RS-232C port in the personal computer.
 Connect the PLC to the USB port in the personal computer using the FX-USB-AW or FX3U-USB-BD.

2. Connection for selecting "USB" (GOT transparent function)

Connect the PLC to the USB port in the personal computer using the transparent function at the USB port in the GOT1000 Series.

3 Setting the communication port and transmission speed

Set these items according to the connection status.

When "USB" is selected in the step 2 above, it is not necessary to set "COM port" and "Transmission speed".

COM port: Select the communication port in the personal computer to be used (among COM1 to COM63).

Transmission speed: Set the communication speed with the FX PLC.
 The applicable transmission speed varies depending on each FX PLC. Refer to the table below.

Communication speed	FX0, FX0S	FX0N	FX1	FX2(FX), FX2c	FX1s	FX1N, FX1NC	FX2N, FX2NC	FX3U, FX3UC*1
9.6 kbps	✓	✓	✓	✓	✓	✓	✓	✓
19.2 kbps	—	—	—	—	—	✓	✓	✓
38.4 kbps	—	—	—	—	—	—	—	✓
57.6 kbps	—	—	—	—	—	—	—	✓
115.2 kbps	—	—	—	—	—	—	—	✓

*1. For achieving communication at 38.4, 57.6, or 115.2 kbps in an FX3U/FX3UC PLC, the FX-232AWC-H, FX-USB-AW, or FX3U-USB-BD is required.

6.1.2 Setting CPU unit (in FX3U and FX3UC)

This setting is required to use the transparent function (two-port interface function) of the GOT-F900 Series in an FX3U/FX3UC PLC.

The setting procedure is described below:

1 Displaying the CPU unit detailed setting window

Double-click the "PLC module" icon  on the connection destination specification window. The window below appears.

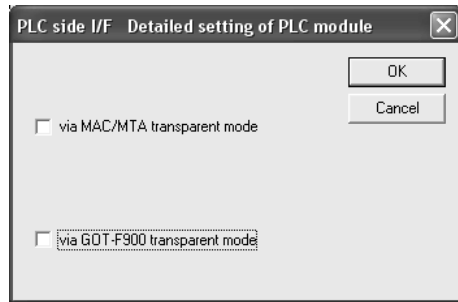

2 Setting the CPU unit

Put a check mark next to "via GOT-F900 transparent mode".

Caution

It is not necessary to put a check mark here when not using the transparent function (two-port interface function) of the GOT-F900 Series.

6.1.3 Setting communication time check and number of retries

The setting procedure for the communication time check and number of retries is described below:

1 Displaying the communication time check/number of retries setting window

Double-click the "No specification" icon  on the connection destination specification window. The window below appears.

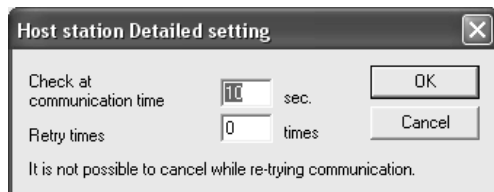

2 Setting the communication time check and number of retries

Check at communication time: Set the time for evaluating error (1 to 9999 sec). If data from the PLC is not received within this time, it is regarded as error.

Initial value: 10 sec

Retry times: Set the number of retries to be executed when a communication error has occurred (0 to 5).

Initial value: 0

Set the above items if necessary.

A	Common Items
B	N:N Network
C	Parallel Link
D	Computer Link
E	Inverter Communication
F	Non-Protocol Communication (RS/RSS2 Instruction)
G	Non-Protocol Communication (FX2N-232IF)
H	Programming Communication
I	Remote Maintenance

6.2 Connection Setting (FXGP/WIN)

FXGP/WIN, Windows software for personal computers, has the following set items. Set each item according to the connection status.

- Communication port
- Transmission speed

6.2.1 Setting communication port and transmission speed

The setting procedure for the communication port and transmission speed is described below:

1 Displaying the communication port/transmission speed setting window

Select [PLC] - [Ports] from the tool menu. The window below appears.

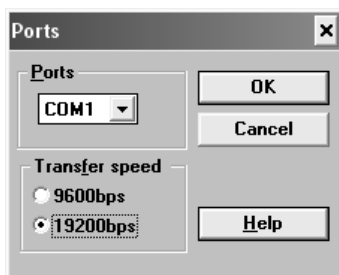

2 Setting the communication port and transmission speed

Set these items according to the connection status.

Ports: Select the communication port in the personal computer to be used (among COM1 to COM9).

Transfer speed: Set the communication speed with the FX PLC.

The applicable transmission speed varies depending on the FX Series. Refer to the table below.

Communication speed	FX0, FX0S	FX0N	FX1	FX2(FX), FX2C	FX1S	FX1N, FX1NC	FX2N, FX2NC	FX3U, FX3UC ^{*1}
9.6 kbps	✓	✓	✓	✓	✓	✓	✓	✓
19.2 kbps	—	—	—	—	—	✓	✓	✓
38.4 kbps	—	—	—	—	—	—	—	—
57.6 kbps	—	—	—	—	—	—	—	—
115.2 kbps	—	—	—	—	—	—	—	—

*1. The FX3U/FX3UC Series cannot be selected. Select the FX2N Series, and then make a program.

6.3 Communication Test (Only in GX Developer)

GX Developer, Windows software for personal computers, has a function to test communication with PLC. Execute the communication test using the following procedure:

1 Selecting [Online]-[Transfer Setup] from the tool menu.

The window below appears.

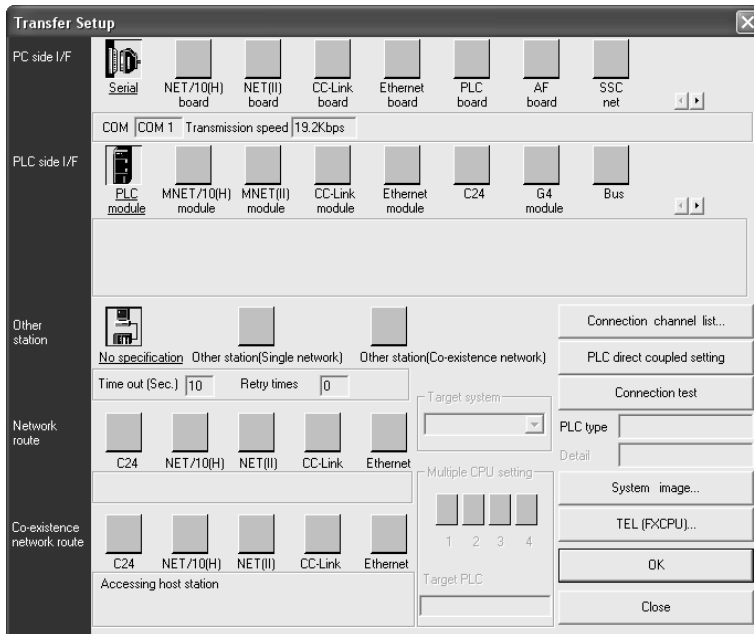

Caution

While the monitor function window is displayed, [Transfer Setup] cannot be selected.

2 Executing the communication test

Click [Connection test] to execute the communication test.

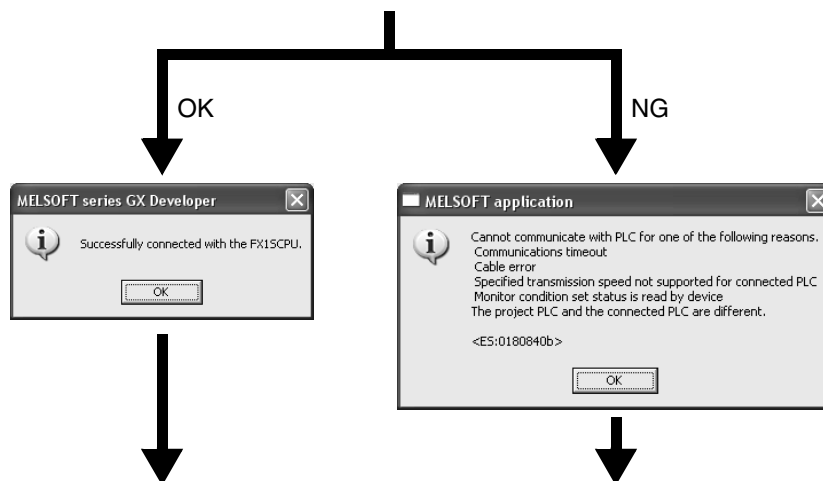

The communication test finished normally

Verify that the connection method is correct:

- Port (COM) number in the personal computer
- Cable configuration

Click [OK].

7. Troubleshooting

This chapter explains troubleshooting.

7.1 Checking PLC Version Applicability

When executing programming communication using an FX PLC and communication equipment operating in accordance with RS-422 or RS-232C, verify that the FX PLC is an applicable version.

→ For the version applicability check, refer to Section 1.3.

7.2 Checking Programming Tool Applicability

Verify that the programming tool version is applicable in programming communication.

→ For the version applicability check, refer to Section 1.4.

7.3 Checking Communication Status Based on LED Indication

Check the status of the "RXD (RD)" and "TXD (SD)" indicator LEDs provided in the optional equipment.

LED status		Operation status
RXD (RD)	TXD (SD)	
Flashing	Flashing	Data is being sent or received.
Flashing	Off	Data is received, but is not sent.
Off	Flashing	Data is sent, but is not received.
Off	Off	Data is not sent nor received.

7.4 Checking Installation

1. Mounting status

If the communication equipment is not securely connected to the PLC, communication is disabled.

→ For the mounting method, refer to the manual of each communication equipment.

7.5 Checking Parameters in PLC

1. Checking the communication setting

Verify that non-protocol communication or computer link communication is not set in the parameters in the FX PLC. If such communication is already set, programming communication with optional communication equipment cannot be used.

→ For the setting of parameters in the PLC, refer to Chapter 5.

7.6 Checking Sequence Program

1. Checking the contents of the communication setting

Verify that each device for the communication format (D8120 and D8420), N:N Network (D8173 to D8280) and Parallel Link (M8070 and M8071) is used in a sequence program.
If each device is used in a sequence program, communication is not executed correctly.

2. Presence of VRRD and VRSC instructions (except FX3U and FX3UC PLCs)

Verify that VRRD and VRSC instructions are not used in a program.
If these instructions are used, delete them, turn OFF the PLC power, and then turn it ON again.

3. Presence of RS instruction (except FX3U and FX3UC PLCs)

Verify that RS instruction is not used in a program.
If this instruction is used, delete it, turn OFF the PLC power, and then turn it ON again.

4. Presence of RS and RS2 instructions (in FX3U and FX3UC PLCs)

Verify that RS and RS2 instructions are not used in the same channel.
If these instructions are used in the same channel, delete them, turn OFF the PLC power, and then turn it ON again.

5. Presence of EXTR instruction (in FX2N and FX2NC PLCs)

Verify that EXTR instruction is not used in a program.
If this instruction is used, delete it, turn OFF the PLC power, and then turn it ON again.

6. Presence of IVCK, IVDR, IVRD, IVWR, and IVBWR instructions (in FX3U and FX3UC PLCs)

Verify that IVCK, IVDR, IVRD, IVWR and IVBWR instructions are not used in the same channel.
If these instructions are used in the same channel, delete them, turn OFF the PLC power, and then turn it ON again.

7.7 Checking Setting in Programming Tool

Verify that the contents of setting in the programming tool are correct.

1. Checking the communication port

Verify that the communication port is set correctly.

2. Checking the transmission speed

Verify that the transmission speed is set correctly.

→ For the setting in the programming tool, refer to Chapter 6.

A

Common Items

B

N:N Network

C

Parallel Link

D

Computer Link

E

Inverter Communication

F

Non-Protocol Communication (RS/RS2 Instruction)

G

Non-Protocol Communication (FX2N-232IF)

H

Programming Communication

I

Remote Maintenance

7.8 Checking Absence/Presence of Errors

1. Checking M8062 (except FX3U and FX3UC PLCs)

When a communication error occurs in the standard built-in port, M8062 turns ON and D8062 stores the corresponding error code.

2. Checking the error code (D8062)

D8062 stores either of the following error codes:

	Error code	Contents of error
D8062	6201	Parity error, overrun error or framing error
	6202	Defective communication character
	6203	Communication data sum mismatch
	6204	Defective data format
	6205	Defective command

3. Checking M8063 and M8438

When a communication errors occur in optional communication equipment, M8063 turns ON and D8063 stores the corresponding error code during communication using ch1, and M8438 turns ON and D8438 stores the corresponding error code during communication using ch2.

4. Checking the error code

D8063 and D8438 store either of the following error codes:

Error code		Contents of error
D8063 (ch1)	D8438 (ch2)	
6301	3801	Parity error, overrun error or framing error
6302	3802	Defective communication character
6303	3803	Communication data sum mismatch
6304	3804	Defective data format
6305	3805	Defective command
6306	3806	Monitoring timeout
6307	3807	Modem initialization error
6308	3808	N:N Network parameter error
6312	3812	Parallel link parameter error
6313	3813	Parallel link sum error
6314	3814	Parallel link format error
6320	3820	Error in communication with inverter

FX Series Programmable Controllers

User's Manual [Remote Maintenance]

Foreword

This manual explains "remote maintenance" provided in MELSEC-F FX Series Programmable Controllers and should be read and understood before attempting to install or use the unit. Store this manual in a safe place so that you can take it out and read it whenever necessary. Always forward it to the end user.

This manual confers no industrial property rights or any rights of any other kind, nor does it confer any patent licenses. Mitsubishi Electric Corporation cannot be held responsible for any problems involving industrial property rights which may occur as a result of using the contents noted in this manual.

© 2005 MITSUBISHI ELECTRIC CORPORATION

A
Common Items

B
N:N Network

C
Parallel Link

D
Computer Link

E
Inverter Communication

F
Non-Protocol Communication (RS/RS2 Instruction)

G
Non-Protocol Communication (FX2N-232IF)

H
Programming Communication

I
Remote Maintenance

1. Outline

This chapter explains the outline of remote maintenance.

1.1 Outline of System

Remote maintenance performs program transfer and device monitoring using Windows programming software with a PLC connected to the telephone line by way of a modem.

1.1.1 Maintenance for programs in PLC

- 1) Sequence programs can be changed by transferring programs and write during RUN.
- 2) Maintenance can be performed by device monitoring, PLC diagnosis, forced ON/OFF and changing set values and current values.
- 3) The line can be connected from a personal computer to a modem connected to a PLC.

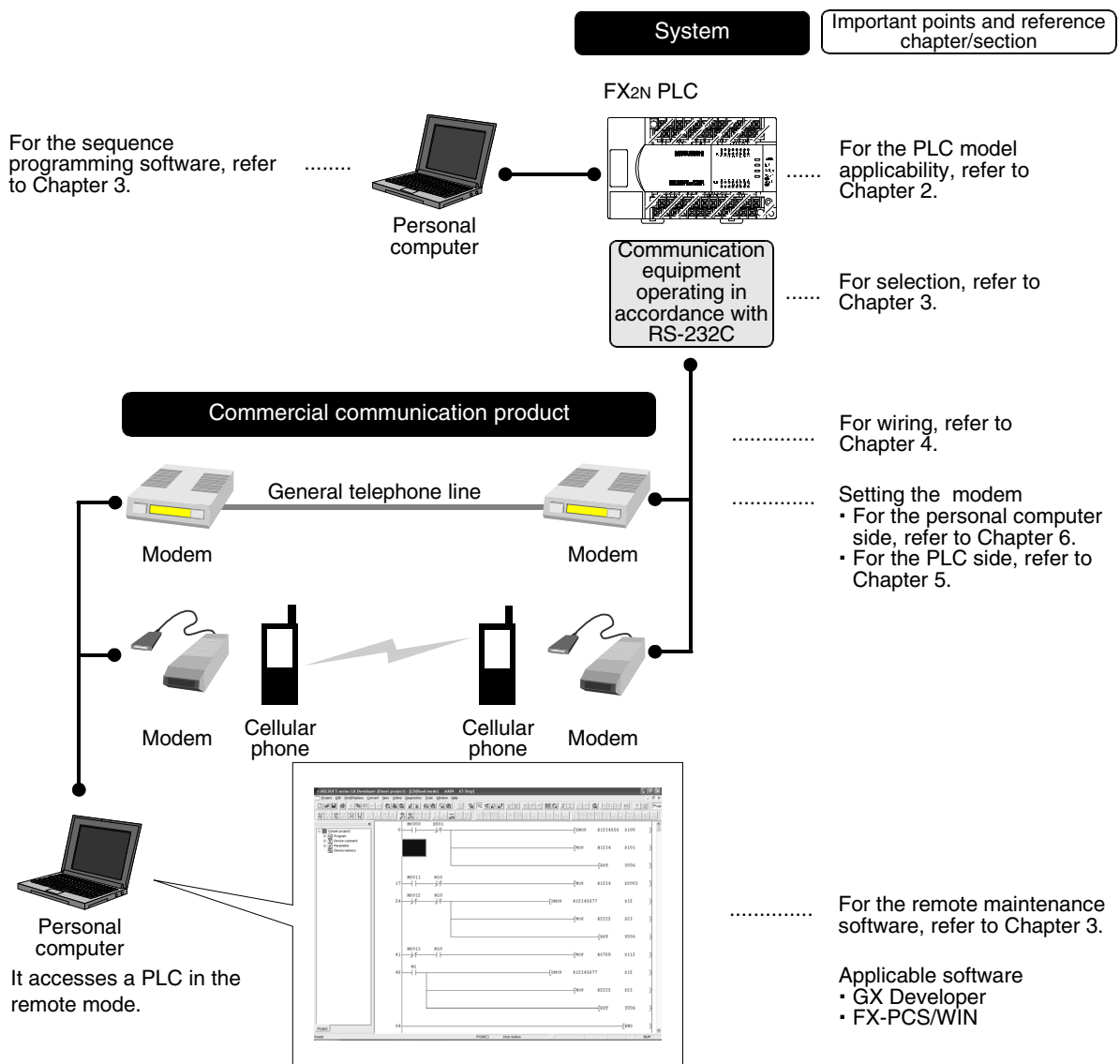

A	Common Items
B	N:N Network
C	Parallel Link
D	Computer Link
E	Inverter Communication
F	Non-Protocol Communication (RS/RS2 Instruction)
G	Non-Protocol Communication (FX2N-232IF)
H	Programming Communication
I	Remote Maintenance

1.1.2 File transfer between personal computers (supported only by FXGP/WIN)

This manual does not describe the operating procedure for this function, but the modem setting contents and setting procedure in personal computers can be used as reference.
 For the detailed explanation of this function, refer to "FX-PCS/WIN SOFTWARE MANUAL."

1) Transferring sequence program files between personal computers

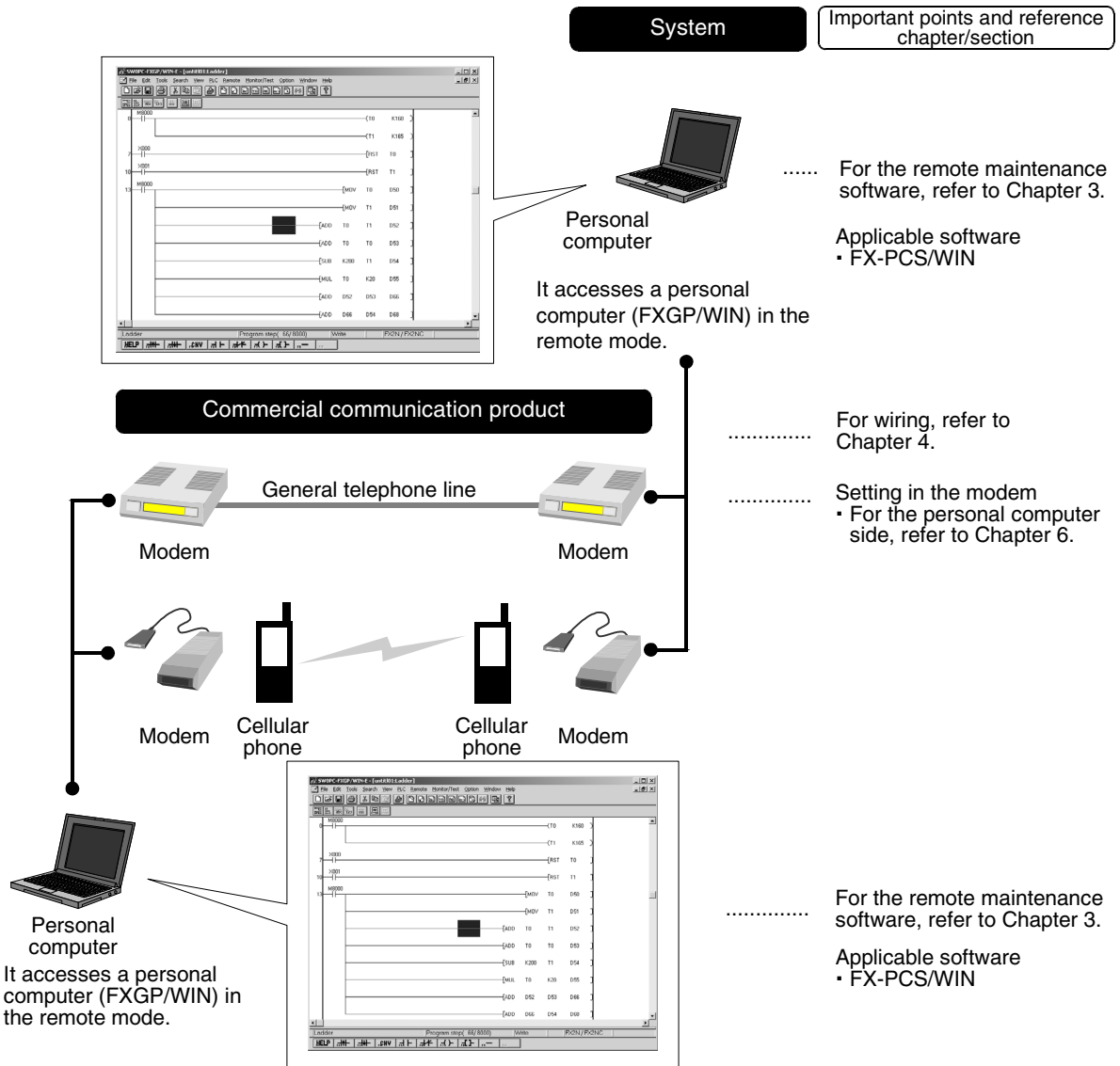

1.2 Major Procedures until Operation

The flow chart below shows the procedures for setting remote maintenance until communication:

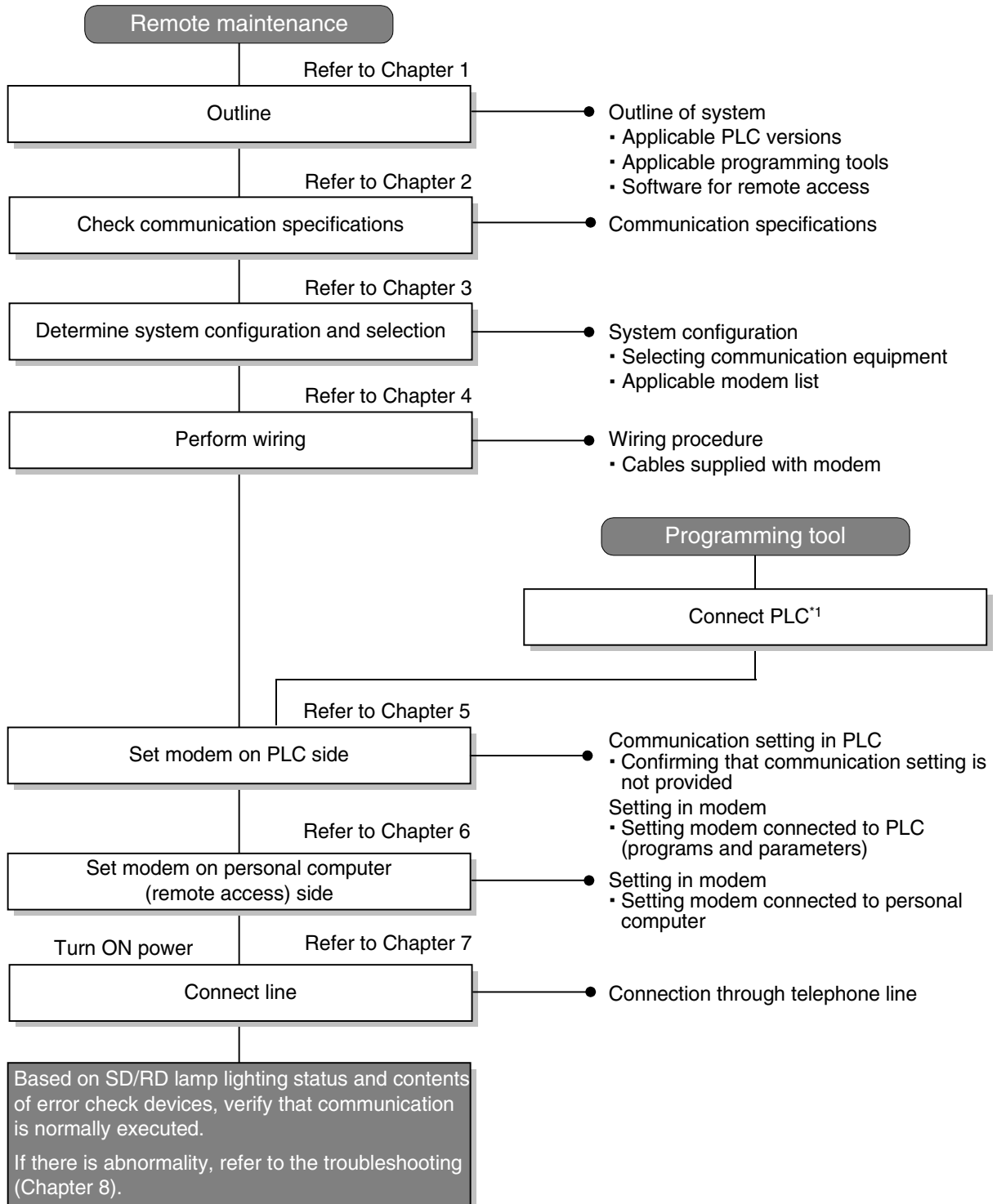

*1 For the method to connect a programming tool to a PLC, refer to the section "Programming Communication" in this manual or the manual of each programming tool.
 For details on operating procedures, refer to the manual of each programming tool.

A	Common Items
B	N:N Network
C	Parallel Link
D	Computer Link
E	Inverter Communication
F	Non-Protocol Communication (RS/RS2 Instruction)
G	Non-Protocol Communication (FX2N-232IF)
H	Programming Communication
I	Remote Maintenance

1.3 Communication Type Applicability in PLC

1.3.1 Applicable versions

The communication types are applicable in the following versions.

✓: Applicable (If applicable versions are limited, they are described inside ().)

—: Not applicable

PLC	Applicability (applicable version)	Remarks
FX3UC Series	✓	
FX3U Series	✓	
FX2NC Series	✓	
FX2N Series	✓	ME3314 (OMRON) is applicable to Ver. 2.01 and later.
FX1NC Series	✓	
FX1N Series	✓	
FX1S Series	✓	
FX0N Series	—	This function is not available
FX0S Series	—	This function is not available
FX0 Series	—	This function is not available
FX2C Series	—	This function is not available
FX2(FX) Series	—	This function is not available
FX1 Series	—	This function is not available

1. Version check

The D8001(decimal) special data register contains information for determining the PLC version.

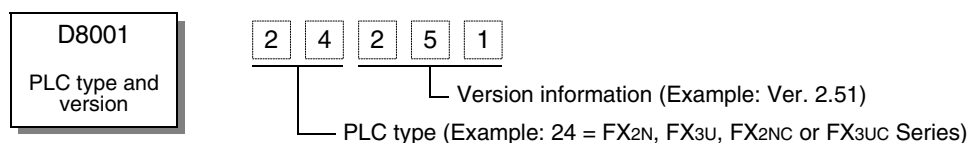

1.3.2 Products whose production was stopped

The table below shows series in which production of the main unit, communication equipment, etc. is stopped.

Use the description on system configuration, etc. in this manual for maintenance.

PLC	Products whose production was stopped	Remarks
FX0 Series	June 30, 2002	Maintenance is offered within 7 years from the end of production (until June 30, 2009).
FX2C Series		
FX2(FX) Series		
FX1 Series		

1.4 Programming Tool Applicability

1.4.1 Programming tool for setting modem connected to PLC

The tables below show programming tools applicable to the modem setting using parameters and sequence programs.

→ For programming software on remote maintenance, refer to Subsection 1.4.2

For applicable versions

The programming tool is applicable in each FX Series from the following version:

1. Japanese versions

✓: Applicable (If applicable versions are limited, they are described inside ().)

—: Not applicable

Model name (Media model name is shown below)	Applicability (applicable version)	Remarks
FX3U and FX3UC PLCs		
GX Developer SW□D5C(F)-GPPW-J	✓ (Ver. SW8 P or later) Ver. 8.13P	Select the model "FX3UC"
FX2N and FX2NC PLCs		
GX Developer SW□D5C(F)-GPPW-J	✓ (Ver. SW2 A or later)	Select the model "FX2N/FX2NC"
FX-PCS/WIN SW0PC-FXGP/WIN	✓ (Ver. 2.10 or later)	
FX-PCS-KIT/98 SW1PC-FXGP/98(-3,-5)	✓ (Ver. 4.00 or later)	
FX-PCS/98-3 SW1PC-FXGP/98-3	✓ (Ver. 4.00 or later)	
FX-PCS-KIT/V-3 SW1-PC-FXGP/V3	✓ (Ver. 2.00 or later)	
FX-A7PHP-KIT SW1RX-GPPFX	✓ (Ver. 3.00 or later)	
FX1S, FX1N and FX1NC PLCs		
GX Developer SW□D5C(F)-GPPW-J	✓ (Ver. SW5 A or later)	Select the model "FX1S/FX1N"
FX-PCS/WIN SW0PC-FXGP/WIN	✓ (Ver. 4.00 or later)	
FX-PCS/98-3 SW1PC-FXGP/98-3	✓ (Ver. 5.00 or later)	

2. English versions

✓: Applicable (If applicable versions are limited, they are described inside ().)

—: Not applicable

Model name (Media model name is shown below)	Applicability (applicable version)	Remarks
FX3U and FX3UC PLCs		
GX Developer SW□D5C(F)-GPPW-E	✓ (Ver. SW8 P or later) Ver. 8.13P	Select the model "FX3UC"
FX2N and FX2NC PLCs		
GX Developer SW□D5C(F)-GPPW-E	✓ (Ver. SW2 A or later)	Select the model "FX2N/FX2NC"
FX-PCS/WIN-E SW0PC-FXGP/WIN-E	✓ (Ver. 1.00 or later)	
FX1S, FX1N and FX1NC PLCs		
GX Developer SW□D5C(F)-GPPW-E	✓ (Ver. SW5 A or later)	Select the model "FX1S/FX1N"
FX-PCS/WIN-E SW0PC-FXGP/WIN-E	✓ (Ver. 3.00 or later)	

In the case of non-applicable versions (setting an alternative model)

Even software not applicable to a PLC can create programs when an alternative model is set. In this case, however, programming is enabled only in the function ranges provided for the alternative PLC model such as instructions and program size.

1. Japanese versions

✓: Applicable (If applicable versions are limited, they are described inside ().)
—: Not applicable

Model name	Applicability (applicable version)	Remarks
FX1s, FX1N, FX3U, FX1NC and FX3UC PLCs		
GX Developer SW□D5C(F)-GPPW-J	✓ (Ver. SW2 A or later)	For FX3U and FX3UC PLC The models "FX3U" and "FX3UC" cannot be selected. "FX2N" can be selected and set as the alternative model. The PP modem mode (ch1) and PP modem mode (ch2) cannot be set.
FX-PCS/WIN SW0PC-FXGP/WIN	✓ (Ver. 2.10 or later)	
FX-PCS-KIT/98 SW1PC-FXGP/98(-3,-5)	✓ (Ver. 4.00 or later)	For FX1N PLC
FX-PCS/98-3 SW1PC-FXGP/98-3	✓ (Ver. 4.00 or later)	The models "FX1N" and "FX1NC" cannot be selected. "FX2N" or "FX2NC" can be selected and set as the alternative model.
FX-PCS-KIT/V-3 SW1-PC-FXGP/V3	✓ (Ver. 2.00 or later)	For FX1S PLC
FX-A7PHP-KIT SW1RX-GPPFX	✓ (Ver. 3.00 or later)	The versions on the left are not applicable. The versions shown in the above table are applicable.
FX2N and FX2NC PLCs		
The versions applicable to FX2N and FX2NC PLCs shown in the above table can be used.		

2. English versions

✓: Applicable (If applicable versions are limited, they are described inside ().)
—: Not applicable

Model name	Applicability (applicable version)	Remarks
FX1s, FX1N, FX3U, FX1NC and FX3UC PLCs		
GX Developer SW□D5C(F)-GPPW-E	✓ (Ver. SW2 A or later)	For FX3U and FX3UC PLC The models "FX3U" and "FX3UC" cannot be selected. "FX2N" can be selected and set as the alternative model. The PP modem mode (ch1) and PP modem mode (ch2) cannot be set.
FX-PCS/WIN-E SW0PC-FXGP/WIN-E	✓ (Ver. 1.00 or later)	For FX1N PLC The models "FX1N" and "FX1NC" cannot be selected. "FX2N" or "FX2NC" can be selected and set as the alternative model. For FX1S PLC The versions on the left are not applicable. The versions shown in the above table are applicable.
FX2N and FX2NC PLCs		
The versions applicable to FX2N and FX2NC PLCs shown in the above table can be used.		

Other programming tools not shown above are not applicable.

1.4.2 Programming software for remote maintenance

The table below shows programming software for a personal computer which uses remote access.

→ For the applicability of programming tools for setting the modem, refer to Subsection 1.4.1.

In the case of applicable versions

The programming software is applicable from the following versions:

1. Japanese versions

✓: Applicable (If applicable versions are limited, they are described inside ().)
—: Not applicable

Model name (Media model name is shown below)	Applicability (applicable version)	Remarks
FX3U and FX3UC PLCs		
GX Developer SW□D5C(F)-GPPW-J	✓ (Ver. SW8 P or later) Ver. 8.13P	Select the model "FX3UC" When connecting the programming software to a PLC in which the PP modem mode (ch1) or PP modem mode (ch2) is set, use Ver. 8.18U or later.
FX2N and FX2NC PLCs		
GX Developer SW□D5C(F)-GPPW-J	✓ (Ver. SW2 A or later)	Select the model "FX2N/FX2NC"
FX-PCS/WIN SW0PC-FXGP/WIN	✓ (Ver. 2.10 or later)	
FX1S, FX1N and FX1NC PLCs		
GX Developer SW□D5C(F)-GPPW-J	✓ (Ver. SW5 A or later)	Select the model "FX1S/FX1N"
FX-PCS/WIN SW0PC-FXGP/WIN	✓ (Ver. 4.00 or later)	

2. English versions

✓: Applicable (If applicable versions are limited, they are described inside ().)
—: Not applicable

Model name (Media model name is shown below)	Applicability (applicable version)	Remarks
FX3U and FX3UC PLCs		
GX Developer SW□D5C(F)-GPPW-E	✓ (Ver. SW8 P or later) Ver. 8.13P	Select the model "FX3UC" When connecting the programming software to a PLC in which the PP modem mode (ch1) or PP modem mode (ch2) is set, use Ver. 8.18U or later.
FX2N and FX2NC PLCs		
GX Developer SW□D5C(F)-GPPW-E	✓ (Ver. SW2 A or later)	Select the model "FX2N/FX2NC"
FX-PCS/WIN-E SW0PC-FXGP/WIN-E	✓ (Ver. 1.00 or later)	
FX1S, FX1N and FX1NC PLCs		
GX Developer SW□D5C(F)-GPPW-E	✓ (Ver. SW5 A or later)	Select the model "FX1S/FX1N"
FX-PCS/WIN-E SW0PC-FXGP/WIN-E	✓ (Ver. 3.00 or later)	

3. In the case of non-applicable versions

The non-applicable programming software version cannot offer remote maintenance.

If your programming software is a non-applicable version, upgrade versions.

To upgrade versions, contact your dealer.

1.4.3 Cautions on using FXGP/WIN

1. When FXGP/WIN is used in the following Windows environment, remote maintenance cannot be used:

- Windows NT4.0
- Windows 2000
- Windows XP

2. For FX3U and FX3UC Series

The models "FX3U" and "FX3UC" cannot be selected.

"FX2N" can be selected and set as the alternative model.

However, FXGP/WIN cannot be connected to a PLC in which the PP modem mode is set.

2. Specifications

This chapter explains the communication specifications and performance.

2.1 Communication Specifications (Reference)

Communication is executed in the (fixed) specifications shown in the table below. Any specification item such as baud rate cannot be changed.

Only modems supporting the communication specifications below can be used.

Item	Modem mode		Remarks
Transmission standard	RS-232C standard		
Maximum total extension distance	15 m (49' 2") or less		
Protocol type	Modem mode		
Communication method	Half-duplex, asynchronous system		
Baud rate	9600 bps		Modem ↔ PLC Modem ↔ Personal computer
Character format			
Start bit	1-bit		
Data bit	7-bit	8-bit	When PP modem mode (ch1) or PP modem mode (ch2) is set, "Data bit: 8-bit" and "Parity bit: Not provided" are set automatically.
Parity bit	Even	Not provided	
Stop bit	1-bit		
Header	Fixed		
Terminator			
Control line	Not provided		
Sum check	Fixed		
Applicable FX Series			
FX3UC Series	✓	✓	
FX3U Series	✓	✓	
FX2NC Series	✓	—	
FX2N Series	✓	—	
FX1NC Series	✓	—	
FX1N Series	✓	—	
FX1S Series	✓	—	

A

Common Items

B

N:N Network

C

Parallel Link

D

Computer Link

E

Inverter Communication

F

Non-Protocol Communication (RS/RS2 Instruction)

G

Non-Protocol Communication (FX2N-232IF)

H

Programming Communication

I

Remote Maintenance

3. System Configuration and Selection

This chapter explains the configuration of communication equipment operating in accordance with RS-232C and selection of the system required by FX PLCs.

3.1 System Configuration

This section explains the outline of the system configuration required to use remote maintenance. Connect (optional) equipment operating in accordance with RS-232C to the FX PLC main unit.

1, **2** and **3** indicate the pattern types of combination of communication equipment.

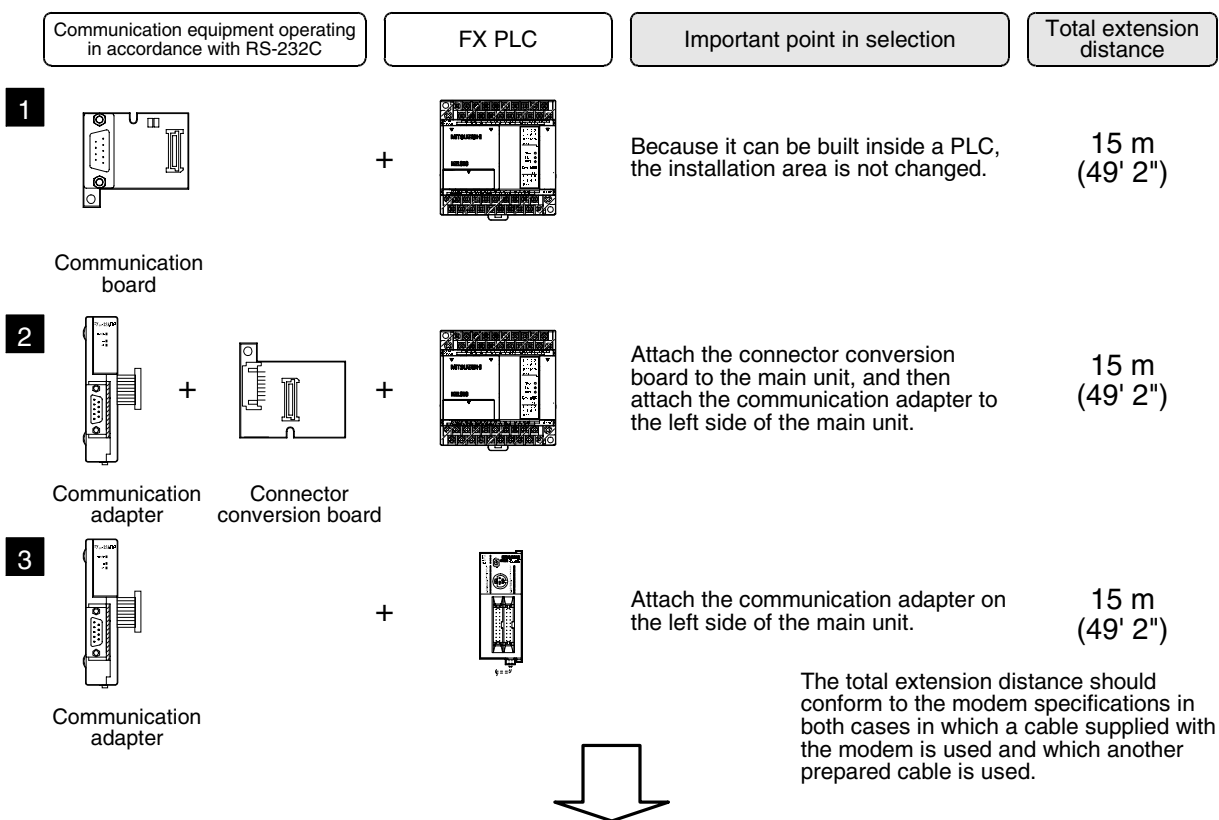



For combinations of communication equipment for each FX Series, refer to the next page.

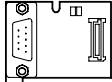
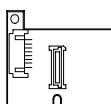
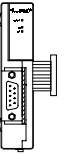
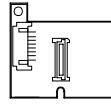
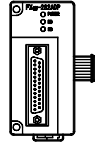
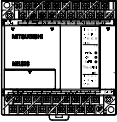
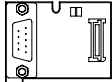
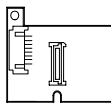
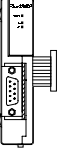
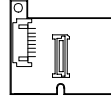
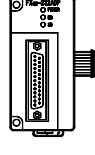
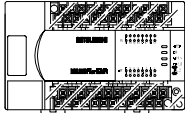
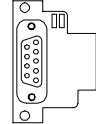
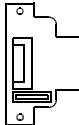
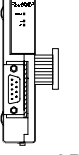

3.2 Setting Applicable FX PLC and Communication Equipment

Select a combination of (optional) communication equipment, and put a check mark in the "Check" column. During selection, pay attention to the following:

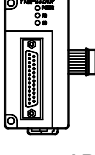
- In the table below, only the outside dimensions and D-SUB connector shape are different between units of shown in "232ADP/232ADP". Select either one.
- Remote maintenance is not provided in the FX0, FX0s, FX0N, FX1, FX2(FX) and FX2c Series.

FX Series	Communication equipment (option)	Total extension distance	Check
 FX1s	 FX1N-232-BD (9-pin D-Sub)	15 m (49' 2")	
	 +  /  +  FX1N-CNV-BD FX2NC-232ADP (9-pin D-Sub) FX1N-CNV-BD FX0N-232ADP (25-pin D-Sub)	15 m (49' 2")	
 FX1N	 FX1N-232-BD (9-pin D-Sub)	15 m (49' 2")	
	 +  /  +  FX1N-CNV-BD FX2NC-232ADP (9-pin D-Sub) FX1N-CNV-BD FX0N-232ADP (25-pin D-Sub)	15 m (49' 2")	
 FX2N	 FX2N-232-BD (9-pin D-Sub)	15 m (49' 2")	
	 +  /  +  FX2N-CNV-BD FX2NC-232ADP (9-pin D-Sub) FX2N-CNV-BD FX0N-232ADP (25-pin D-Sub)	15 m (49' 2")	

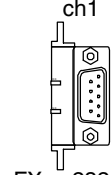
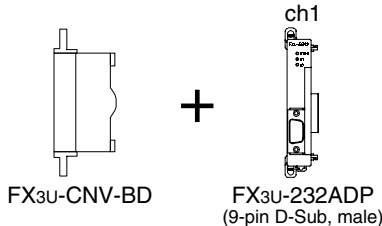
A	Common Items
B	N:N Network
C	Parallel Link
D	Computer Link
E	Inverter Communication
F	Non-Protocol Communication (RS/RS2 Instruction)
G	Non-Protocol Communication (FX2N-232IF)
H	Programming Communication
I	Remote Maintenance

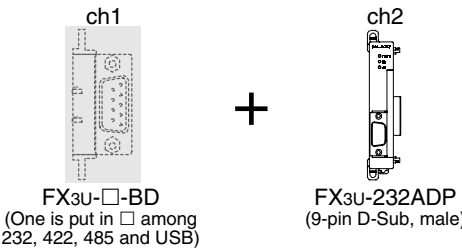
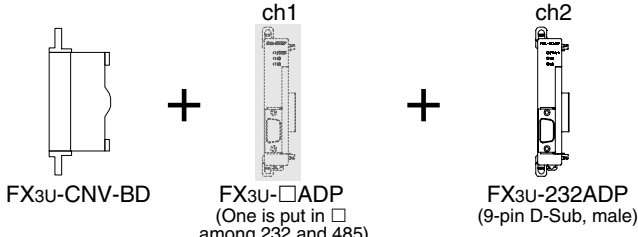
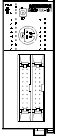
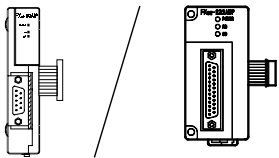
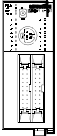
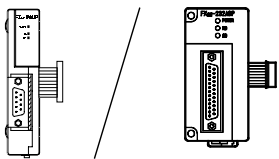
FX Series	Communication equipment (option)	Total extension distance	Check
When using channel 1 (ch 1)			
	 <p>FX3U-232-BD (9-pin D-Sub, male)</p>	15 m (49' 2")	
	 <p>FX3U-CNV-BD + FX3U-232ADP (9-pin D-Sub, male)</p>	15 m (49' 2")	
 <p>FX3U</p>	When using channel 2 (ch 2)^{*1}		
	 <p>FX3U-□-BD (One is put in □ among 232, 422, 485 and USB) + FX3U-232ADP (9-pin D-Sub, male)</p>	15 m (49' 2")	
	 <p>FX3U-CNV-BD + FX3U-□-ADP (One is put in □ among 232 and 485) + FX3U-232ADP (9-pin D-Sub, male)</p>	15 m (49' 2")	
 <p>FX1NC</p>	 <p>FX2NC-232ADP (9-pin D-Sub) / FX0N-232ADP (25-pin D-Sub)</p>	15 m (49' 2")	
 <p>FX2NC</p>	 <p>FX2NC-232ADP (9-pin D-Sub) / FX0N-232ADP (25-pin D-Sub)</p>	15 m (49' 2")	

*1. When using ch2 in an FX3U PLC, it can be set only in the PP modem mode (ch2).

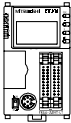
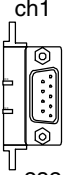
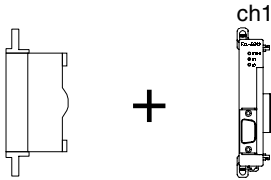
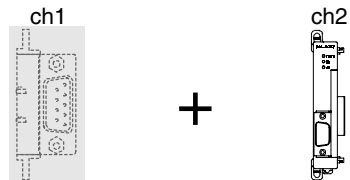
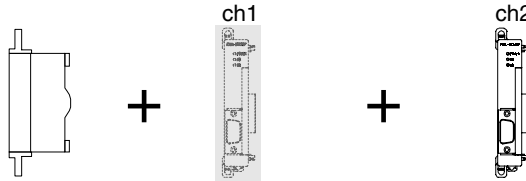
FX Series	Communication equipment (option)	Total extension distance	Check
 <p>FX3UC</p>	When using channel 1 (ch 1)		
	 <p>ch1 FX3U-232-BD (9-pin D-Sub, male)</p>	15 m (49' 2")	
	 <p>FX3U-CNV-BD + FX3U-232ADP (9-pin D-Sub, male)</p>	15 m (49' 2")	
	When using channel 2 (ch 2)*1		
	 <p>ch1 + ch2 FX3U-□-BD (One is put in □ among 232, 422, 485 and USB) + FX3U-232ADP (9-pin D-Sub, male)</p>	15 m (49' 2")	
	 <p>FX3U-CNV-BD + ch1 + ch2 FX3U-□-ADP (One is put in □ among 232 and 485) + FX3U-232ADP (9-pin D-Sub, male)</p>	15 m (49' 2")	

*1. When using ch2 in an FX3UC PLC, it can be set only in the PP modem mode (ch2).

A	Common Items
B	N:N Network
C	Parallel Link
D	Computer Link
E	Inverter Communication
F	Non-Protocol Communication (RS/RS2 Instruction)
G	Non-Protocol Communication (FX2N-232IF)
H	Programming Communication
I	Remote Maintenance

3.3 Selecting Modem

In FX PLCs, the modems PV-AF288 (manufactured by AIWA) and ME3314B (manufactured by OMRON) are applicable.

When "user registration mode," "PP modem mode (ch1)," or "PP modem mode (ch2)" is selected in the modem initialization setting in an FX PLC, other modems are also applicable.

The tables below show the communication specifications in the "user registration mode," "PP modem mode (ch1)," and "PP modem mode (ch2)." Select a modem supporting the communication specifications shown below.

1. User registration mode

Item	Contents
Communication method	Half-duplex, asynchronous system
Baud rate	9600 bps
Start bit	1-bit
Data bit	7-bit
Parity bit	Even
Stop bit	1-bit
Control line	Not provided

If the modem used does not support the communication specifications shown above, communication is disabled.

2. PP modem mode (ch1) and PP modem mode (ch2)

Item	Contents
Communication method	Half-duplex, asynchronous system
Baud rate	9600 bps
Start bit	1-bit
Data bit	8-bit
Parity bit	Not provided
Stop bit	1-bit
Control line	Not provided

If the modem used does not support the communication specifications shown above, communication is disabled.

3.3.1 List of modems whose operations are confirmed

The tables below show modems whose operations are already confirmed and the setting contents of their AT command.

1. Modem on the PLC side

FXGP/WIN has a command to initialize the PV-AF288 (manufactured by AIWA) and ME3314B (manufactured by OMRON). This command can be used only by setting a parameter.

For other modems, input and set the AT command shown below in ASCII codes to a data register (D1000 and later).
→ For the setting procedure, refer to Chapter 5.

Manufacturer	AT command setting for modem on PLC side		AT command	Remarks
	Modem model name	SW□D5C-GPPW		
Manufactured by I/O DATA				
DFML-K56F	Input AT command shown on right		ATE0Q1S0=2&D0&K0&W0&Y0\Q0%C3	
Manufactured by AIWA				
PV-AF288	Select AIWA modem (PV-AF288)		ATE0S0=2Q1&D0&M5\Q0\J0&W	
PV-BF5606	Input AT command shown on right		ATE0S0=2&D0Q1&K0&W	
Manufactured by OMRON				
ME3314B	Select OMRON modem (ME3314B)		ATE0S0=2Q1&D0&H0&R1S15=8&W	In FX2N PLCs, Ver. 2.01 and later are applicable.
ME5614E	Input AT command shown on right		ATE0S0=2&D0Q1&K0&W	Modem version: F/W Ver. 2.300
ME5614D	Input AT command shown on right		ATE0S0=2&D0Q1&K0&W	Modem version: F/W Ver. 2.300
Manufactured by NTT DoCoMo				
96F1	Input AT command shown on right		ATE0S0=2&D0\Q1	
96F2	Input AT command shown on right		ATE0S0=2&D0\Q1Q1	

2. Modem on the personal computer for remote access

The table below shows modems whose operations are already confirmed. Input and set the AT command shown below using a programming tool in the personal computer on the remote access side.

FXGP/WIN has a command to initialize the PV-AF288, PV-AF3360 (manufactured by AIWA), ME3314B, ME5614D and ME5614E (manufactured by OMRON). This command can be used only by setting a parameter.

→ For the setting procedure, refer to Chapter 6.

Manufacturer	AT command setting for modem on side of personal computer for remote access		Remarks
	Modem model name	FX-PCS/WIN	
Manufactured by AIWA			
PV-AF288	Select this model (AT command is shown for reference) ATE0S0=2Q0V1&M4\J0\Q0		—
PV-AF3360	Select this model (AT command is shown for reference) ATE0S0=2Q0V1S15=8&H0&R1		—
PV-BF5606	Select this model (AT command is shown for reference) ATE0S0=2&K0		ATE0S0=2&K0&D0
Manufactured by OMRON			
ME3314B	Select this model (AT command is shown for reference) ATE0S0=2Q0V1S15=8&H0&R1		—
ME5614E	Select this model (AT command is shown for reference) ATE0S0=2&K0W0		ATE0S0=2&K0&D0 Modem version: F/W Ver. 2.300
ME5614D	Select this model (AT command is shown for reference) ATE0S0=2&K0W0		ATE0S0=2&K0&D0 Modem version: F/W Ver. 2.300
Manufactured by NTT DoCoMo			
96F1	ATQ0V1E1S0=0		ATQ0V1E1S0=0 SW□D5C-GPPW version: Former than SW3
96F2	ATQ0V1E1		ATQ0V1E1 SW□D5C-GPPW version: Former than SW3
			ATQ0V1E1\Q1 SW□D5C-GPPW version: SW4 or later

4. Wiring

This chapter explains the wiring.

4.1 Wiring Procedure

1 Turning OFF the PLC power

Before starting the wiring work, make sure that the PLC power is OFF.

2 Checking the connector shape

When a cable is included with the modem, check the shape of the RS-232C connector in the personal computer to be connected, the shape of the connector in the communication equipment operating in accordance with RS-232C for the PLC, and insertion possibility (male or female type).

3 Connecting the RS-232C ports in the modem and the PLC with a cable

Check the shape of the connector (number of pins) in the communication equipment operating in accordance with RS-232C to be connected to the PLC. Each cable has either connector shape:

- 9-pin D-Sub, female
- 25-pin D-Sub, male

4 Connecting the personal computer for remote access and the modem with a cable

Check the shape of the RS-232C connector (number of pins) in the personal computer for remote access.

4.2 Connection Diagram

1. For connecting the modem, use a cable included with the modem or cable described in the modem manual.

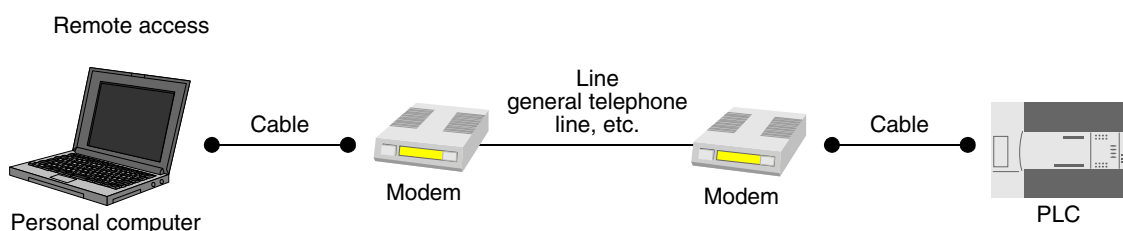

2. The table below shows the pin arrangement in the communication equipment operating in accordance with RS-232C for the FX PLC.

FX0N-232ADP		FX1N-232-BD, FX2N-232-BD, FX2NC-232ADP, FX3U-232-BD, FX3U-232ADP		Signal name	Function
25-pin D-Sub, female		9-pin D-Sub, male			
	—		1*1	CD	Receiving carrier detection
	3		2	RD (RXD)	Receive data input
	2		3	SD (TXD)	Send data output
	20		4	ER (DTR)	Data terminal ready
	7		5	SG (GND)	Signal ground
	6		6	DR (DSR)	Data set ready

*1. The FX2NC-232ADP does not use the CD signal.

5. How to Set Modem on PLC Side

This chapter explains how to set parameters for initialization using the AT command and set the communication specifications including the transmission speed for a modem connected to the PLC. The setting method using GX Developer and the setting method using FXGP/WIN are explained respectively.
→ For applicable programming tools, refer to Subsection 1.4.2.

5.1 Setting Using GX Developer

This section explains the modem initialization setting and communication setting methods. Suppose that GX Developer is already started up.

5.1.1 Setting communication by way of RS-232C port

It is not necessary to set the serial communication with a modem. However, it is necessary to verify that another communication type is not used and whether the communication setting is correct using the following procedure.

In FX PLCs, the communication setting can be executed using either of the following two methods:

- 1) Writing the value "0" to the data register D8120 using a sequence program
If another communication type is already set for another application, delete the sequence program which writes a value to D8120.
When setting remote maintenance to ch2 in an FX3U/FX3UC PLC, write the value "0" to the data register D8420.
- 2) Setting parameters using a sequence programming tool
By using the following procedure, verify that another communication type is not set.

1 Opening the PLC parameter setting window

Double-click [Parameter]-[PLC parameter] from the project tree.

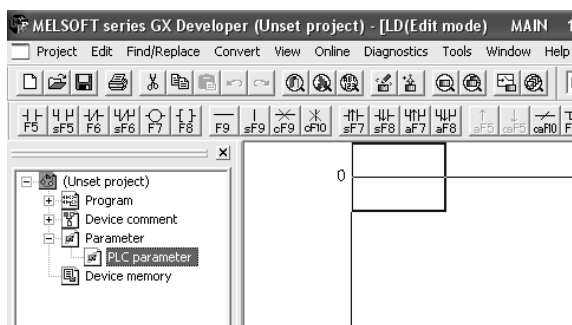

If the project tree is not displayed, select [View] - [Project data list] from the tool menu (to display a check mark on the left side).

A

Common Items

B

N:N Network

C

Parallel Link

D

Computer Link

E

Inverter Communication

F

Non-Protocol Communication (RS/RS2 Instructio)

G

Non-Protocol Communication (FX2N-232IF)

H

Programming Communication

I

Remote Maintenance

2 Checking the serial communication (parameter) setting

Click the [PLC system(2)] tab on the dialog box.

Confirm that a check mark (✓) is not in the check box "Operate communication setting," and click the [End] button.

If a check mark (✓) is provided, delete it, and then click the [End] button.

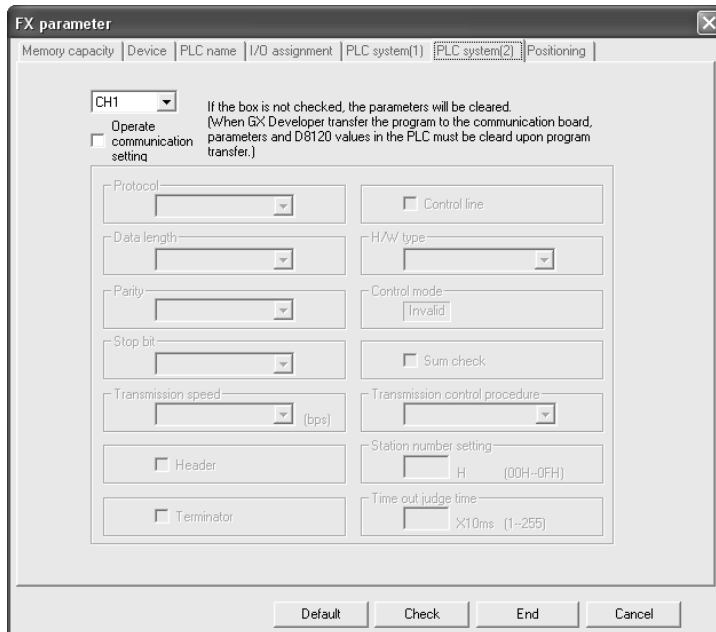

5.1.2 Modem initialization setting in parameter method

This subsection explains how to select the AT command for initialization registered in the PLC and how to set the AT command for an unregistered modem.

1 Opening the PLC parameter setting window

Double-click [Parameter] - [PLC parameter] from the project tree.

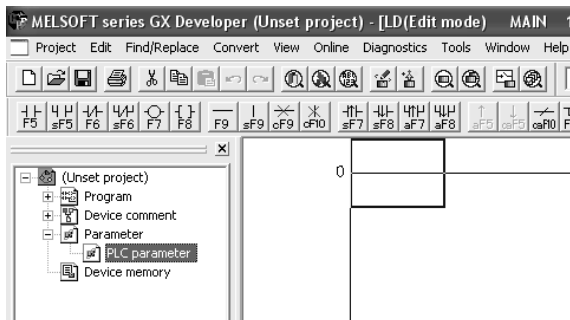

If the project tree is not displayed, select [View] - [Project data list] from the tool menu (check mark on the left side).

2 Selecting the modem initialization method

Click the [PLC system(1)] tab on the dialog box.

Select a modem to be connected in "MODEM initialized," and click the [End] button.

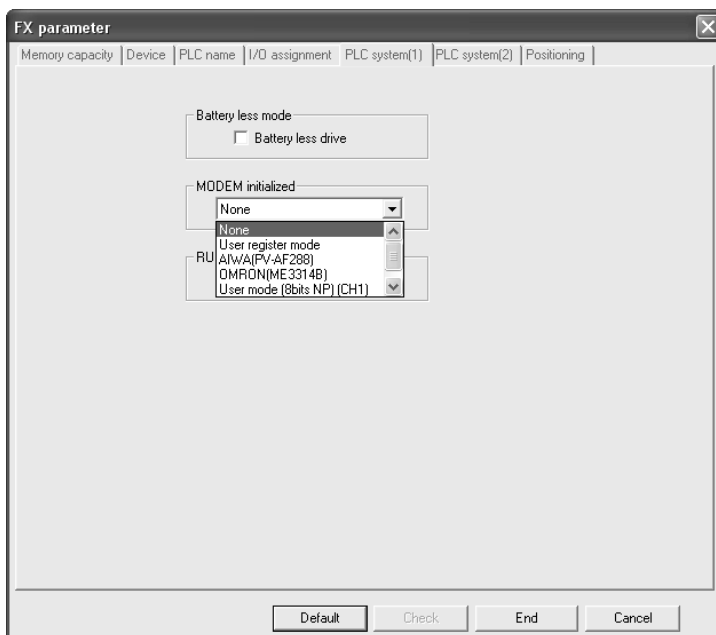

Set item	Description	Modem model name	Manufacturer
None	Select this item when remote maintenance is not used.	—	—
User register mode	Select this item when the modem to be used is not registered.	Unregistered modem	—
AIWA(PV-AF288)	Select the corresponding item when either modem is to be used.	PV-AF288	AIWA
OMRON(ME3314B)		ME3314B	OMRON
User mode (8bits NP) (CH1)*1	Select this item when the modem to be used satisfying the PP modem mode specifications is not registered.	Unregistered modem	—
User mode (8bits NP) (CH2)*1	Select this item when remote maintenance is executed in ch2.	Unregistered modem	—

*1. When an FX3U/FX3UC PLC is used

3 Setting the AT command for the unregistered modem

When "User register mode," "User mode (8bits NP) (CH1)," or "User mode (8bits NP) (CH2)" is selected in "MODEM initialized", the AT command setting is required. For the AT command setting method for unregistered modems, refer to Subsection 5.1.3. The AT command setting is not required when "AIWA[PV-AF288]" or "OMRON(ME3314B)" is selected.

4 Writing the parameter and program to the PLC

Select [Online]-[Write to PLC] from the tool menu.
Click [Parameter]-[PLC parameter] in the tree.
When the AT command is set for an unregistered modem, next put a check mark next to "Device memory"- "MAIN."
After placing the check mark, click the [Execute] button to write the contents to the FX PLC.

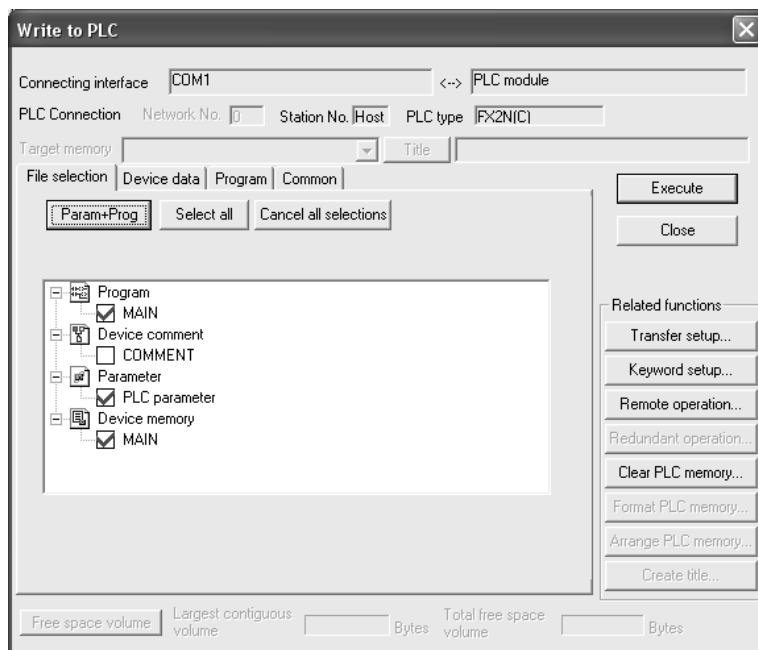

5.1.3 Setting AT command for unregistered modem

Only when "MODEM initialized" is set to "User register mode," "User mode [8bits NP][CH1]," or "User mode [8bits NP][CH2]," execute the following setting.

(The modem initialization setting depends on the setting contents of the [PLC system(1)] tab displayed when [Parameter] - [PLC parameter] is selected in the project tree.)

1 Newly adding a device memory

Select "Device memory" in the project tree, right-click it to display the submenu, and select "New...".

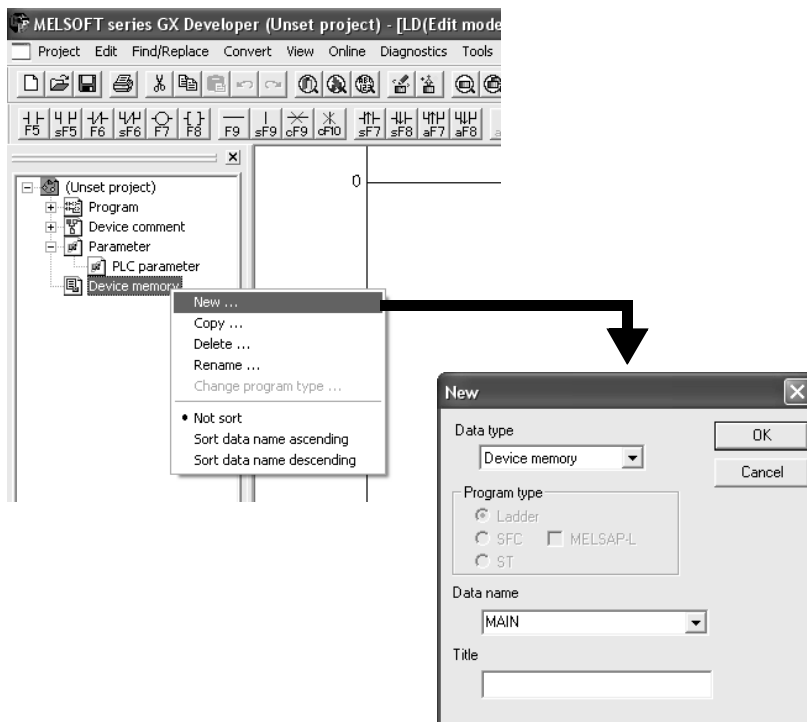

Click the [OK] button on the "New" dialog box.

2 Creating the MAIN data

Click the [Yes] button.

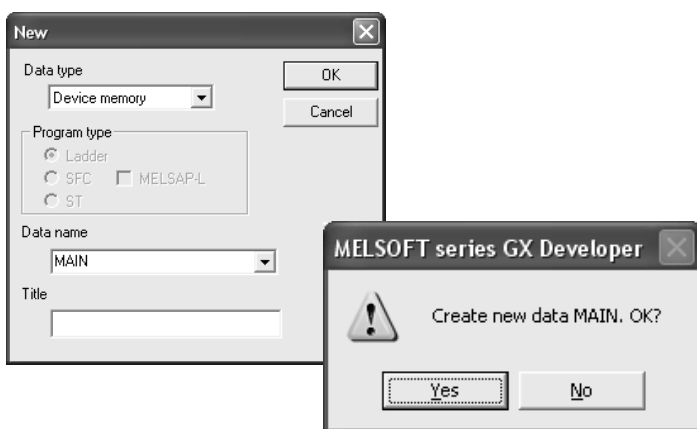

3 Displaying the device list

Input the head number of devices used to set the AT command to "Device Label," and click the [Display] button.

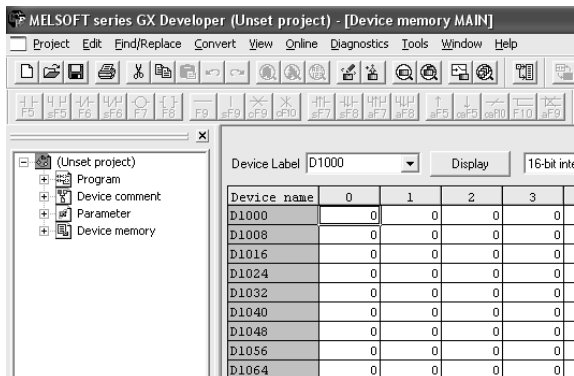

The device (data register) number to be set varies depending on the FX Series as shown below:

FX Series	Device range	FX Series	Device range
FX3U/FX3UC PLC	D1000 to D1059	FX2N/FX2NC PLC	D1000 to D1059
FX1N/FX1NC PLC	D1000 to D1059	FX1S PLC	D200 to D255

4 Inputting the AT command

Input the AT command to D1000 (D200 For FX1S PLC) and later. Input one character to one word. Double-click a data register to be input to display the "Character string input" dialog box. Input one (half-width) character, and click the [OK] button.

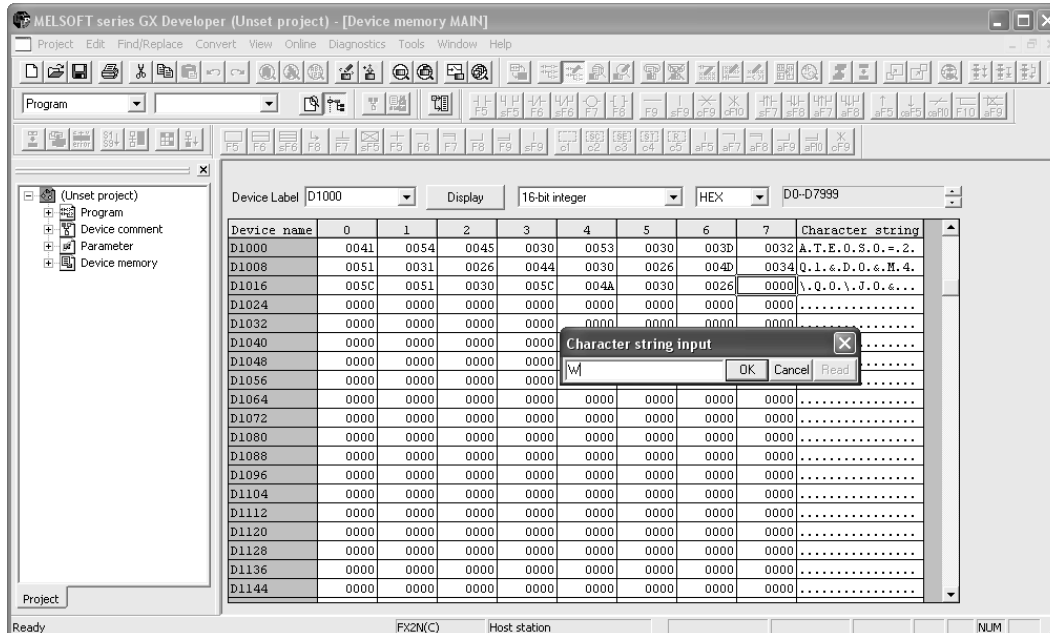

1. AT command structure

For initializing a modem, use the AT command developed by Hayes.
The Hayes AT command is generally expressed in the following format:

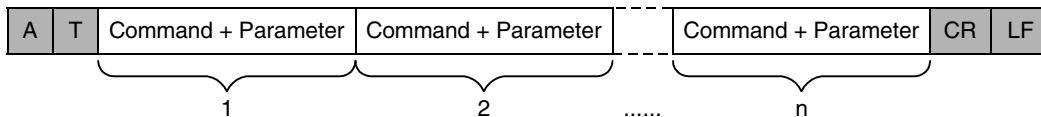

For details on the AT command, refer to the manual of the modem to be used.

2. Input example of the AT command for initialization, Example: ATE0S0 = 2Q1&D0&M4\Q0\J0&W

Data register No.	ASCII code	Hexadecimal value
D1000	A	41
D1001	T	54
D1002	E	45
D1003	0	30
D1004	S	53
D1005	0	30
D1006	=	3D
D1007	2	32
D1008	Q	51
D1009	1	31
D1010	&	26
D1011	D	44
D1012	0	30

Data register No.	ASCII code	Hexadecimal value
D1013	&	26
D1014	M	4D
D1015	4	34
D1016	\	5C
D1017	Q	51
D1018	0	30
D1019	\	5C
D1020	J	4A
D1021	0	30
D1022	&	26
D1023	W	57
D1024	CR	0D
D1025	LF	0A

5 Inputting "CR" and "LF"

It is necessary to input "CR" and "LF" at the end of the AT command.
Input "000D" and "000A" (hexadecimal values) to data registers respectively.

Device Label: Display

Device name	0	1	2	3
D1000	0041	0054	0045	0030
D1008	0051	0031	0026	0044
D1016	005C	0051	0030	005C
D1024	000D	000A	0000	0000
D1032	0000	0000	0000	0000
D1040	0000	0000	0000	0000

If "CR (0DH)" and "LF (0AH)" are not input at the end of the AT command, remote maintenance is disabled.

A	Common Items
B	N:N Network
C	Parallel Link
D	Computer Link
E	Inverter Communication
F	Non-Protocol Communication (RS/RS2 Instruction)
G	Non-Protocol Communication (FX2N-232IF)
H	Programming Communication
I	Remote Maintenance

5.2 Setting Using FXGP/WIN

This section explains the modem initialization setting and communication setting methods.

5.2.1 Setting communication by way of RS-232C port

It is not necessary to set the serial communication with a modem.

However, it is necessary to verify that another communication type is not used and whether the communication setting is correct using the following procedure.

In FX PLCs, the communication setting can be executed using either of the following two methods:

- 1) Writing the value "0" to the data register D8120 using a sequence program
If another communication type is already set for another application, delete the sequence program which writes a value to D8120.
- 2) Setting parameters using a sequence programming tool
By using the following procedure, verify that the communication setting is not provided.

1 Checking the serial communication (parameter) setting

Select [Option]-[Serial setting (parameter)] from the tool menu.

The following dialog box appears according to absence/presence of parameter setting.

1. When there is no parameter setting

The dialog box shown below appears to indicate that there is no communication setting. Click the [No] button.

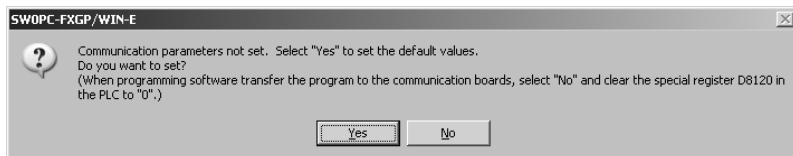

2. When there are already parameter settings

The dialog box shown below appears to indicate that the communication setting is being used. Click the [Clear] button.

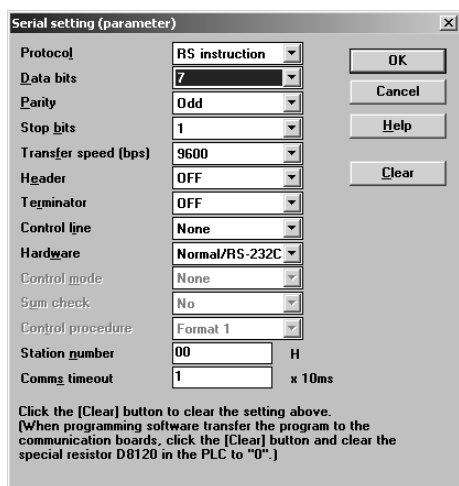

5.2.2 Modem initialization setting in parameter method

This subsection explains how to select the AT command for initialization registered in advance in the PLC and how to set the AT command for an unregistered modem.

1 Setting the PLC mode

Click [Option] - [PLC's mode setting] from the tool menu.

2 Selecting the modem initialization method

Select a modem to be connected in "Modem initialize", and click the [OK] button.

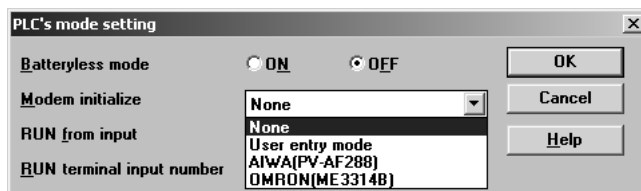

Set item	Description	Modem model name	Manufacturer
None	Select this item when remote maintenance is not used.	—	—
User entry mode	Select this item when the modem to be used is not registered.	Unregistered modem	—
AIWA(PV-AF288)	Select corresponding item when either modem is to be used.	PV-AF288	AIWA
OMRON(ME3314B)		ME3314B	OMRON

3 Setting the AT command for an unregistered modem

When "User entry mode" is selected in "Modem initialize", the AT command setting is required. For the AT command setting method for unregistered modems, refer to Subsection 5.2.3.

The AT command setting is not required when "AIWA(PV-AF288)" or "OMRON(ME3314B)" is selected.

4 Writing the program to the PLC

Click [PLC] - [Transfers] - [Write] from the tool menu to display the "Program write" dialog box. Select "All range", and click the [OK] button.

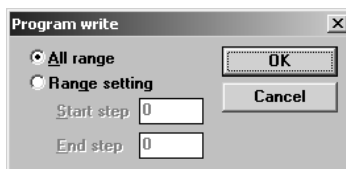

When the AT command is set for an unregistered modem, transfer the register also.

Click [PLC] - [Register data transfers] - [Write] from the tool menu to display the "Write" dialog box. Place a check mark (✓) next to "Data register", and click the [OK] button.



5.2.3 Setting AT command for unregistered modem

Only when "User entry mode" is selected in "Modem initialize", execute the following setting.
(The modem initialization setting depends on the setting contents of the window displayed when [Option] - [PLC's mode setting] is selected in the tool menu.)

1 Displaying the device list

Select [View] - [Register view] from the tool menu.

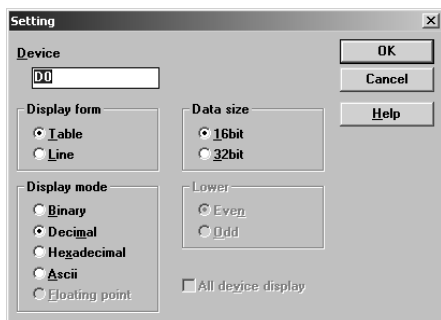

2 Executing the display setting

Select the set items as shown in the table below, and click the [OK] button.

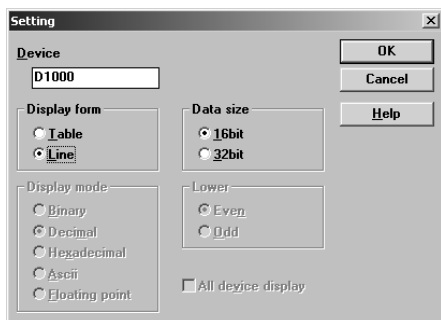

Item	Contents of setting
Display form	Line
Data size	16bit

The device (data register) number to be set varies depending on the FX Series as shown below:

FX Series	Device range	FX Series	Device range
FX3U/FX3UC PLC	D1000 to D1059	FX2N/FX2NC PLC	D1000 to D1059
FX1N/FX1NC PLC	D1000 to D1059	FX1S PLC	D200 to D255

3 Inputting the AT command

Input the AT command to the "ASCII" column of D1000 and later. Input one (half-width) character to one word.

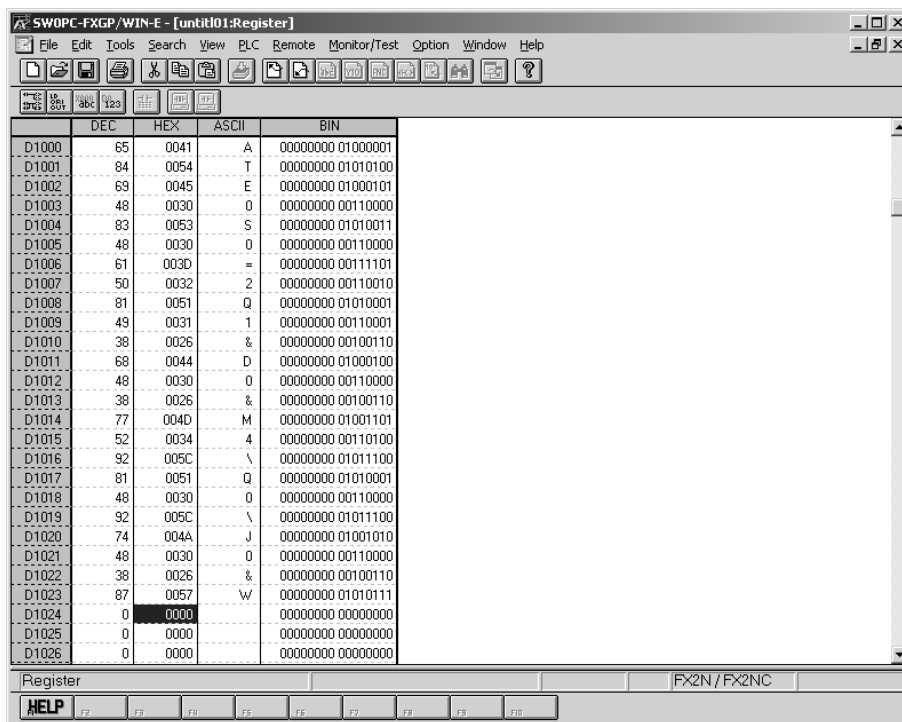

Make sure to input "CR (0DH)" and "LF (0AH)" at the end of the AT command. If they are not input, remote maintenance is disabled. The "CR" and "LF" input method is explained in the next step.

1. AT command structure

For initializing a modem, use the AT command developed by Hayes. The Hayes AT command is generally expressed in the following format:

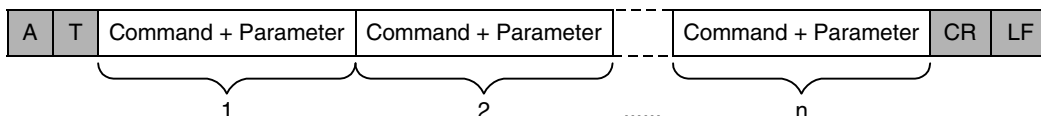

For details on the AT command, refer to the manual of the modem to be used.

2. Input example of the AT command for initialization, Example: ATE0S0 = 2Q1&D0&M4\Q0J0&W

Data register No.	ASCII code	Hexadecimal value
D1000	A	41
D1001	T	54
D1002	E	45
D1003	0	30
D1004	S	53
D1005	0	30
D1006	=	3D
D1007	2	32
D1008	Q	51
D1009	1	31
D1010	&	26
D1011	D	44
D1012	0	30

Data register No.	ASCII code	Hexadecimal value
D1013	&	26
D1014	M	4D
D1015	4	34
D1016	\	5C
D1017	Q	51
D1018	0	30
D1019	\	5C
D1020	J	4A
D1021	0	30
D1022	&	26
D1023	W	57
D1024	CR	0D
D1025	LF	0A

4 Inputting "CR" and "LF"

It is necessary to input "CR" and "LF" at the end of the AT command.
 Input "000D" and "000A" (hexadecimal values) to data registers respectively.

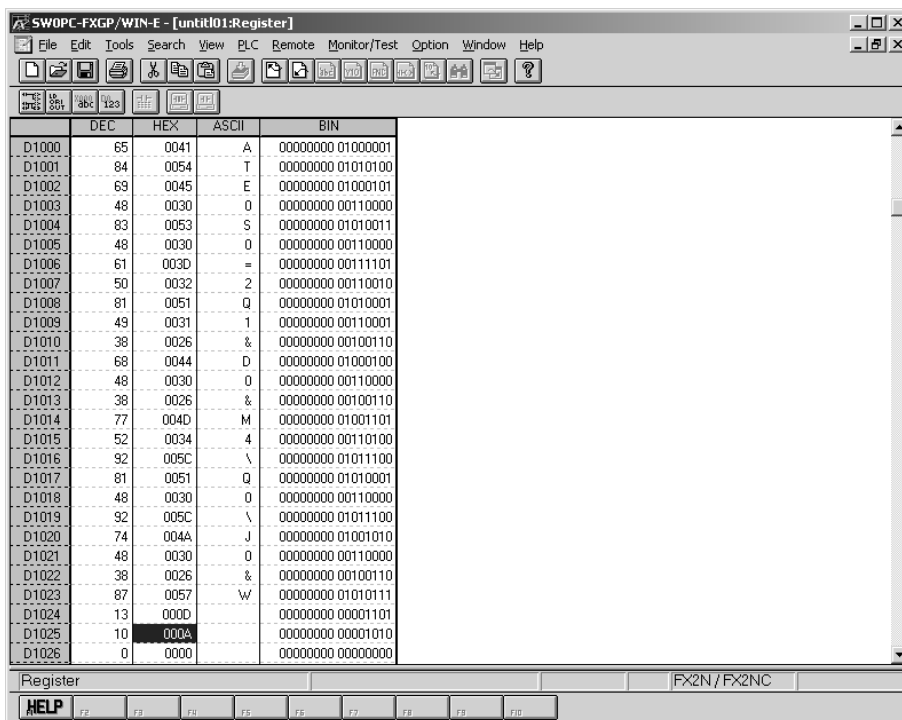

If "CR (0DH)" and "LF (0AH)" are not input at the end of the AT command, remote maintenance is disabled.

5.3 Cautions on Use

1. Cautions on inputting the AT command for initialization to the PLC

- 1) The AT command finishes sending when "0" (hexadecimal value) is read.
- 2) When creating a sequence program, make sure that the input area for the modem initialization command is different from the data register area used by general sequence programs.
- 3) Make sure to input "CR (0DH)" and "LF (0AH)" at the end of the AT command. If they are not input, remote maintenance is disabled.

6. How to Set Modem on Side of Personal Computer for Remote Access

This chapter explains how to set a modem connected to the personal computer for remote access. The setting method using GX Developer and the setting method using FXGP/WIN are explained respectively.
 → For applicable programming tools, refer to Subsection 1.4.2.

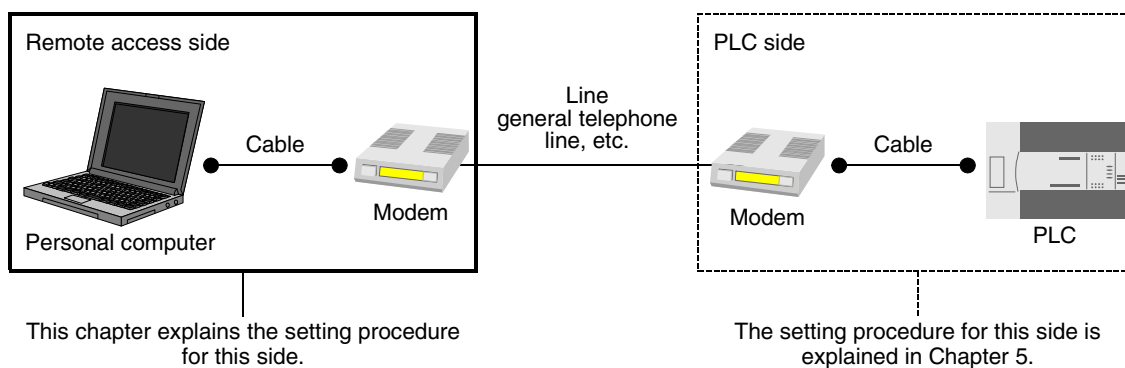

6.1 Setting Using GX Developer

This section explains the line connection setting method using GX Developer.

6.1.1 Registering AT command for connected modem

This subsection explains how to register the AT command for initializing a modem connected to the personal computer.

1 Setting the AT command

Select [Tools] - [Set TEL data] - [AT command registration] from the tool menu to display the following dialog box.

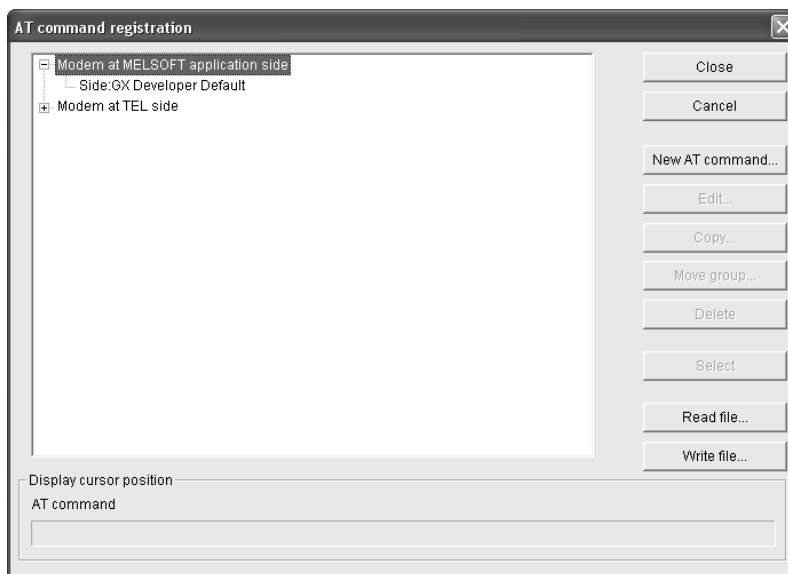

2 Registering the AT command for the connected modem

Select "Modem at MELSOFT application side" in the tree, and click the [New AT command] button. Input "Title" and "AT command," and click the [OK] button.

- Input a name easy to understand such as the modem model name to "Title."
- Input "AT command" while referring to the description below.

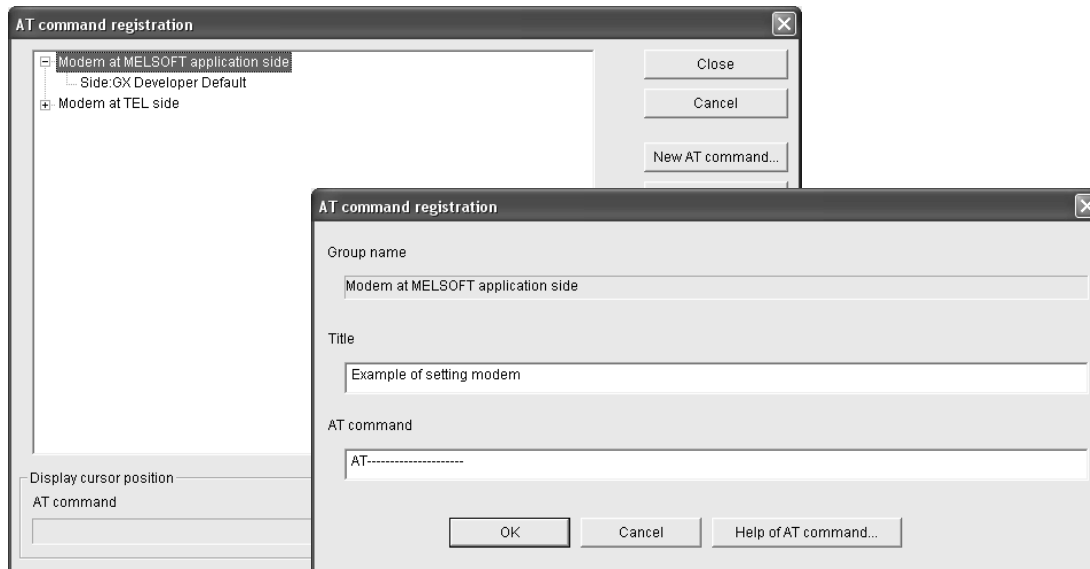

1. In the case of a modem whose operation is confirmed

For such a modem, input the following AT command.

Modem manufacturer name	Modem model name	AT command set value	Remarks
AIWA	PV-BF5606	ATE0S0=2&K0&D0	
OMRON	ME5614E	ATE0S0=2&K0&D0	Modem version: F/W Ver. 2.300
OMRON	ME5614D	ATE0S0=2&K0&D0	Modem version: F/W Ver. 2.300
NTT DoCoMo	96F1	ATQ0V1E1S0=0 (former than SW3)	
NTT DoCoMo	96F2	ATQ0V1E1 (former than SW3) ATQ0V1E1\Q1 (SW4 or later)	

2. In the case of any other modem (whose operation is not confirmed)

Click the [Help of ATcommand] button.

Refer to the contents of the help and the manual of the connected modem, create the AT command.

3. Contents of help for the AT command

The table below shows the contents of description about [Help of ATcommand].

Setting example: AT&C1Q0V1N3&D0&K0

AT command	Description
AT&Cn	Set the mode in which the CD signal is set to ON when the carrier from the counterpart is received.
ATQn	Set the AT command so that the result code for the AT command is sent back.
ATVn	Set the AT command so that the response to the AT command is given in a character string.
AT\Nn	The MNP automatic selection mode is recommended. When the MNP block size is a set item, "128 bytes maximum per block" is general. When the MNP automatic selection mode cannot be specified, specify the direct mode in the asynchronous communication mode.
AT&Dn	Set the ER signal to "normally ON."
AT&Kn (AT&Hn&In&Rn)	Set "no flow control."
AT&Xn	When a converter is used, set "no dial tone." It is not necessary to set this item when a converter is not used.

6.1.2 Creating telephone directory (if necessary)

This subsection explains the method to register the telephone number of the counterpart (line connected to the modem of the desired PLC).

1 Displaying the telephone directory dialog box

Select [Tools] - [Set TEL data] - [Call book] from the tool menu to display the following dialog box.

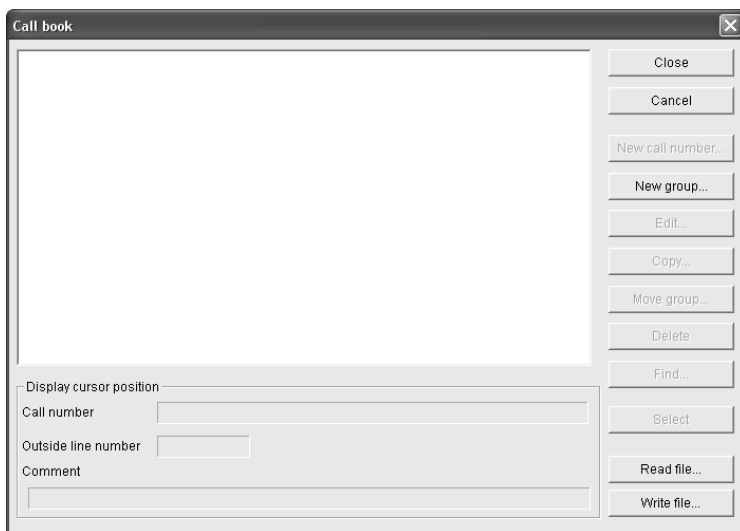

2 Creating the group name

Click the [New group] button to display the "Group setting" dialog box. Input a group name (example: A Corporation) to which telephone numbers belong, and click the [OK] button.

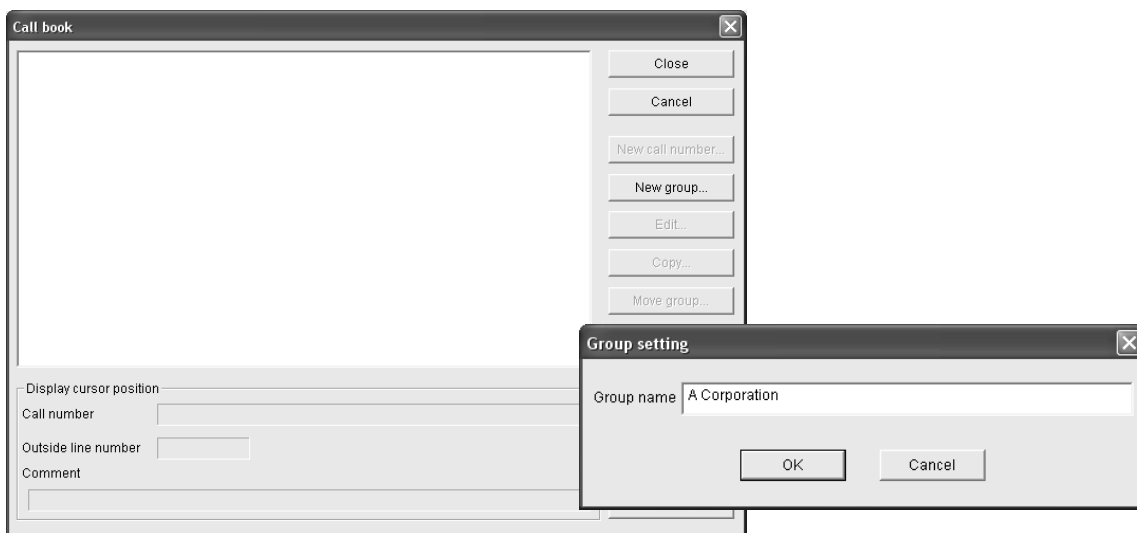

A	Common Items
B	N:N Network
C	Parallel Link
D	Computer Link
E	Inverter Communication
F	Non-Protocol Communication (RS/RS2 Instruction)
G	Non-Protocol Communication (FX2N-232IF)
H	Programming Communication
I	Remote Maintenance

3 Selecting a group name to which the counterpart telephone number will be registered

Click and select an already created group name (example: A Corporation).
Click the [New call number] button.

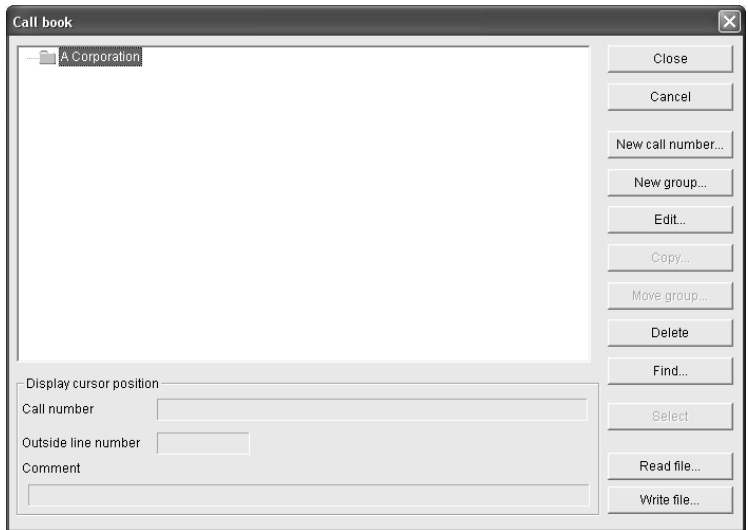

4 Inputting the name, telephone number, etc.

Input required items, and click [OK].
If there is another counterpart to be registered, repeat from the step 2 above.

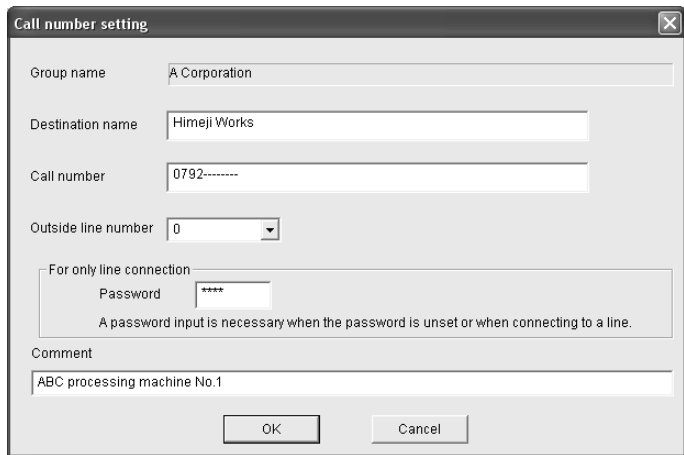

→ For details, refer to the "GX Developer Operating Manual."

6.2 Setting Using FXGP/WIN

This section explains the line connection method using FXGP/WIN.

6.2.1 Registering AT command for connected modem

This subsection explains how to register the AT command for initializing a modem connected to the personal computer for remote access.

1 Setting the AT command

Select [Remote] - [Environment] - [Modem] from the tool menu to display the following dialog box.

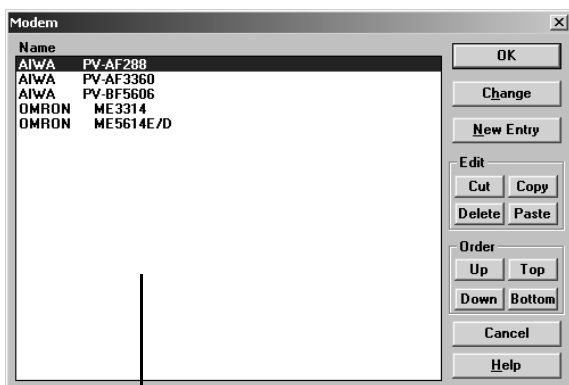

Registered modems are displayed.

2 Registering the AT command for the connected modem

1. When the connected modem is shown in the list

Select the modem model name, and click the [OK] button.

→ Proceed to the step 4.

2. When the connected modem is not shown in the list

It is necessary to create the AT command for the modem, and register it.

→ Proceed to the step 3.

A

Common Items

B

N:N Network

C

Parallel Link

D

Computer Link

E

Inverter Communication

F

Non-Protocol Communication (RS/RS2 Instruction)

G

Non-Protocol Communication (FX2N-232IF)

H

Programming Communication

I

Remote Maintenance

3 Newly creating the AT command for the modem

Click the [New Entry] button.

Input "Name" and "Initial Setup String," and then click the [OK] button.

- To "Name," input a name easy to understand such as the modem model name.
- To "Initial Setup String," input proper contents while referring to the description below.

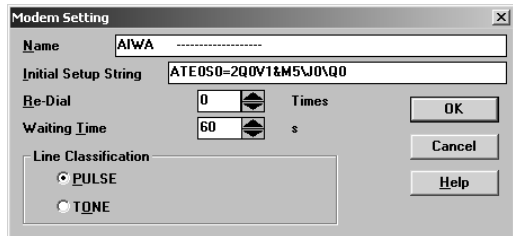

Input the AT command while referring to the description below.

1. In the case of a modem whose operation is confirmed

For a modem whose operation is confirmed, input the following AT command:

Modem manufacturer	Modem model name	AT command set value	Remarks
AIWA	PV-AF288	ATE0S0=2Q0V1&M4\J0\Q0	Only selection is required. (It is already registered.)
AIWA	PV-AF3360	ATE0S0=2Q0V1S15=8&H0&R1	Only selection is required. (It is already registered.)
AIWA	PV-BF5606	ATE0S0=2&K	Only selection is required. (It is already registered.)
OMRON	ME3314B	ATE0S0=2Q0V1S15=8&H0&R1	Only selection is required. (It is already registered.)
OMRON	ME5614E	ATE0S0=2&K0W0	Only selection is required. (It is already registered.) Modem version: F/W Ver. 2.300
OMRON	ME5614D	ATE0S0=2&K0W0	Only selection is required. (It is already registered.) Modem version: F/W Ver. 2.300
NTT DoCoMo	96F1	ATQ0V1E1S0=0	
NTT DoCoMo	96F2	ATQ0V1E1	

2. AT command structure

For initializing a modem, use the AT command developed by Hayes.

The Hayes AT command is generally expressed in the following format:

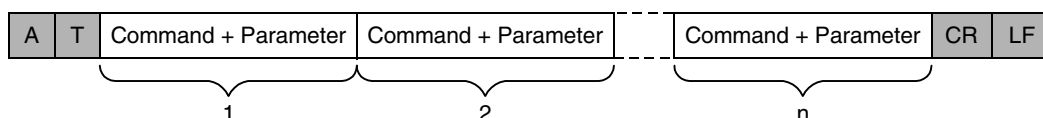

For details on the AT command, refer to the manual of the modem to be used.

3. Setting contents of the AT command

When the PLC power is turned ON, the PLC sends the AT command to the modem to initialize the modem. For reference, the table below shows the set items and setting contents of the AT commands for modems which are registered in advance in FXGP/WIN.

The set items and setting contents may vary depending on each modem. For actual setting contents, refer to the manual of the used modem.

Set item	PV-AF288 (AIWA)	PV-AF3360 (AIWA)	ME3314B (OMRON)
	ATE0S0=2Q0V1&M4\J0\Q0	ATE0S0=2Q0V1&M4\J0\Q0	ATE0S0=2Q0V1S15=8&H0&R1
Command echo	E0 (not provided)	E0 (not provided)	E0 (not provided)
Number of times of calling in automatic receiving	S0 = 2 (twice)	S0 = 2 (twice)	S0 = 2 (twice)
Result code display	Q0 (provided)	Q0 (provided)	Q0 (provided)
Result code format	V1 (character, word)	V1 (character, word)	V1 (character, word)
Communication mode	&M4 (MNP automatic)	&M4 (MNP automatic)	S15 = 8 (V. 42 bis)
Terminal speed fixing mode	\J0 (fixed)	\J0 (fixed)	—
Send data flow control	—	—	&H0 (not provided)
Terminal flow control method	\Q0 (not provided)	\Q0 (not provided)	&R1 (not provided)
Initialization to values set in factory before delivery	&F (FXGP/WIN sends "AT&F", and then sends the above AT command.)		

4 Displaying the selected modem

Verify that the desired modem is set, and click the [OK] button.

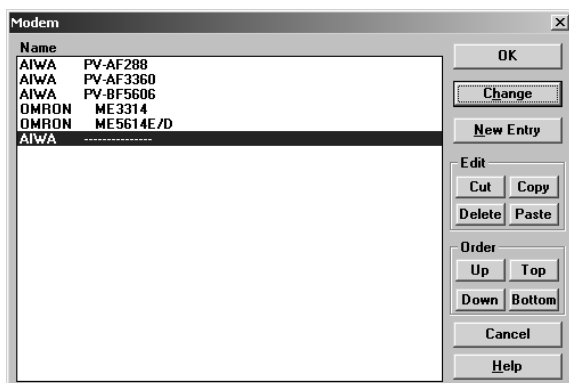

On this window, a newly registered modem is selected.

6.2.2 Registering line connection destination

This subsection explains how to register the telephone number of the line connection destination (line connected to the modem of the desired PLC).

1 Displaying the line connection dialog box

Select [Remote] - [Connect] - [to PLC] from the tool menu to display the following dialog box.

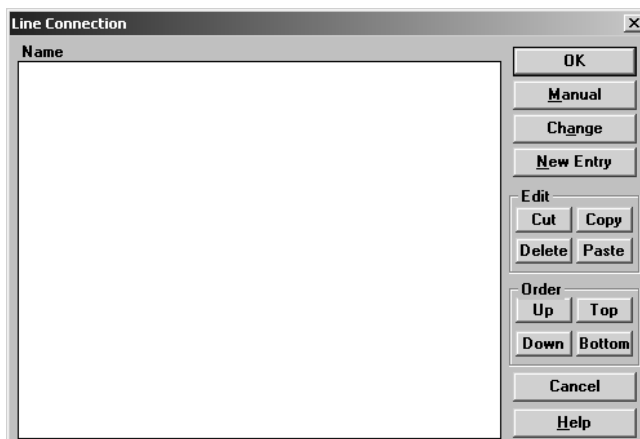

2 Inputting the telephone number of the line connection destination

Click the [New Entry] button.

When the following dialog box appears, input the counterpart name and telephone number.

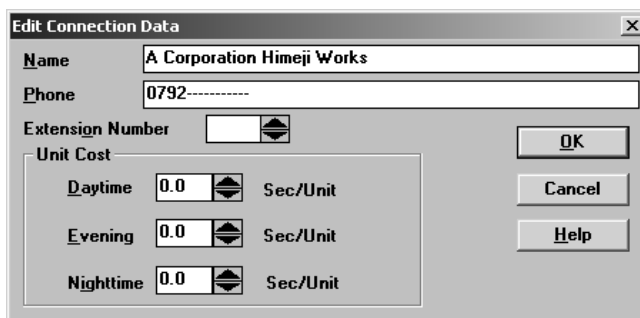

3 Registering the line connection destination

After inputting the telephone number, click the [OK] button to register it.

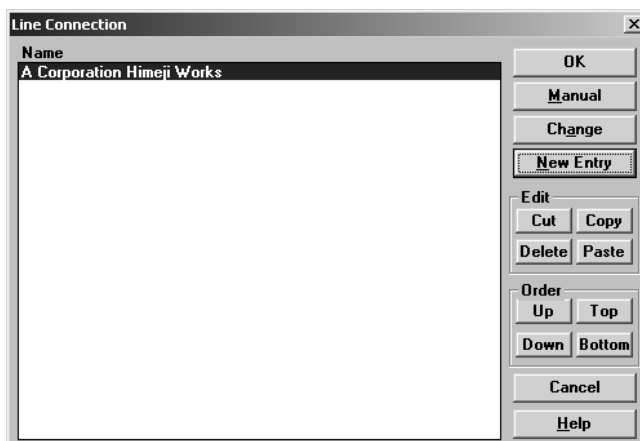

→ For details on set items, refer to the manual of FXGP/WIN.

7. Connecting Line

This chapter explains the line connection procedure for remote maintenance.

7.1 Preparing for Connection of PLC

For remote maintenance, it is necessary to properly establish the modem-to-PLC connection. Set the PLC using the following procedure.

1 Setting initialization for a modem on the PLC side

Set the AT command for a modem to be connected to the PLC.

→ For details, refer to Chapter 6.

2 Turning OFF the PLC power

After inputting the AT command to the PLC, turn OFF the PLC power.

3 Connecting a modem

Connect the communication equipment of the PLC to a modem.

→ For details, refer to Chapter 4.

4 Turning ON the modem power

Turn ON the modem power connected to the PLC.

5 Turning ON the PLC power

After turning ON the power to the modem, turn ON the PLC power.

When the PLC power is turned ON, the TXD (SD) and RXD (RD) LEDs light instantaneously in the optional communication equipment operating in accordance with RS-232C, and the AT command is sent to the modem.

→ If these LEDs do not light, refer "Chapter 8. Troubleshooting".

A

Common Items

B

N:N Network

C

Parallel Link

D

Computer Link

E

Inverter Communication

F

Non-Protocol Communication (RS/RS2 Instruction)

G

Non-Protocol Communication (FX2N-232IF)

H

Programming Communication

I

Remote Maintenance

7.2 Line Connection Procedure

This section explains the procedure to connect a personal computer to a PLC using a telephone line. The connection procedure varies depending on the software used. Connect a telephone line suitable to the software used.

7.2.1 For GX Developer

This subsection explains the line connection procedure using GX Developer. Prepare for connection of the PLC, connect a modem to the communication port in the personal computer, and start up GX Developer.

1 Setting the line connection

Select [Tools] - [Set TEL data] - [Connect line] from the tool menu to display the following dialog box.

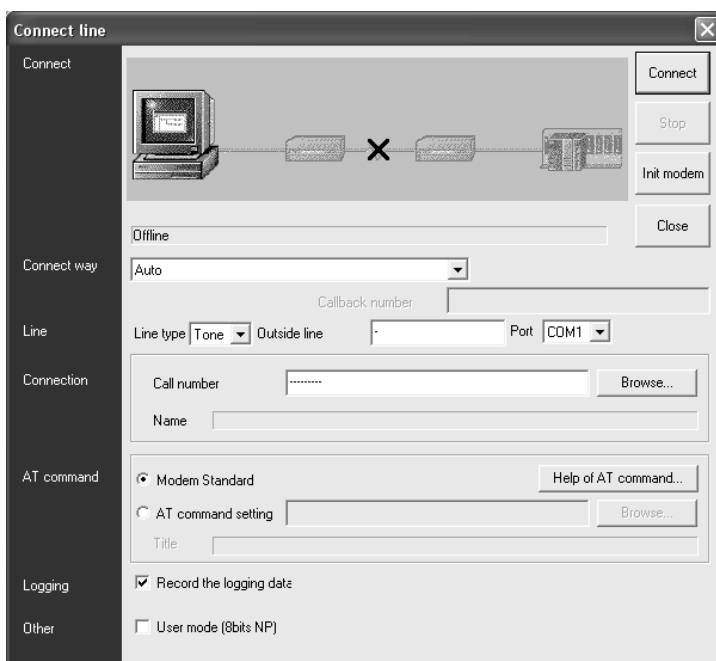

The line connection status is displayed.

2 Setting the connection method

Select "Auto".

3 Setting the line

Set each item as follows:

1. Line type

Set the type of line connected to the modem.

- In the case of general telephone, select the contracted line type (tone, pulse or ISDN).
- In the case of cellular phone, select "Tone".

2. Outside line

Set this item if necessary for making phone calls to outside lines.

3. Port

Select the communication port number in the personal computer connected to the modem.

4 Setting the connection destination

Set the telephone number of the counterpart (line number of the modem connected to the desired PLC).

When a telephone number has been set in advance in the telephone directory, it can be set using the [Browse] button.

→ For details on the telephone directory, refer to Subsection 6.1.2.

5 Setting the AT command

Set the AT command for the modem connected to the personal computer. When the AT command has been registered in advance, it can be set using the [Browse] button.

→ For details on the AT command registration, refer to Subsection 6.1.1.

6 Placing a check mark (✓) next to "Record the logging data"

Put a check mark when here storing the log at the line connection to a file.

The log at the line connection is recorded in the following log file:

- Storage destination: GX Developer installation destination\log (default: Melsec\Gppw\log)
- Log file name: Date.log (example: 980929.log)

7 Setting others

When "User mode (8bits NP) (CH1)" or "User mode (8bits NP) (CH2)" is selected in "Init modem", place a check mark (✓) next to "User mode (8bits NP)".

8 Connecting the line

Click the [Connect] button to display the following dialog box.

Click the [Yes] button to execute line connection and make a call from the modem connected to the personal computer.



9 Checking the line connection status

1. When the line is connected

When the line is connected, the connection status shown below is displayed on the line connection dialog box.

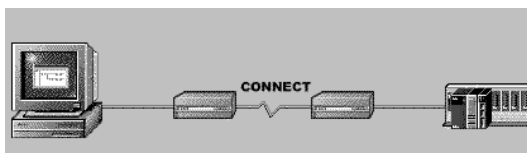

A

Common Items

B

N:N Network

C

Parallel Link

D

Computer Link

E

Inverter Communication

F

Non-Protocol Communication (RS/RS2 Instruction)

G

Non-Protocol Communication (FX2N-232IF)

H

Programming Communication

I

Remote Maintenance

When connection is completed, the following dialog box appears to indicate the telephone number of the connection destination and the communication speed.

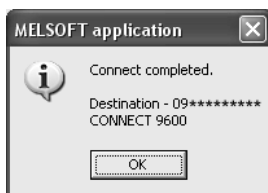

Confirm the contents, and click the [OK] button to close the dialog box.

→ Proceed to the step 10.

2. When the line cannot be connected

When the line cannot be connected, the following figure is displayed on the line connection dialog box. (Example: When no response is given by the modem connected to the personal computer)

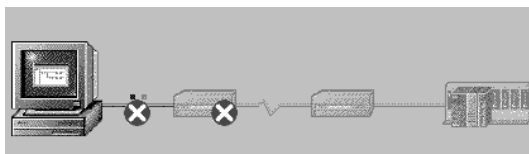

And the following dialog box appears.



Click the [OK] button to display the option settings dialog box.

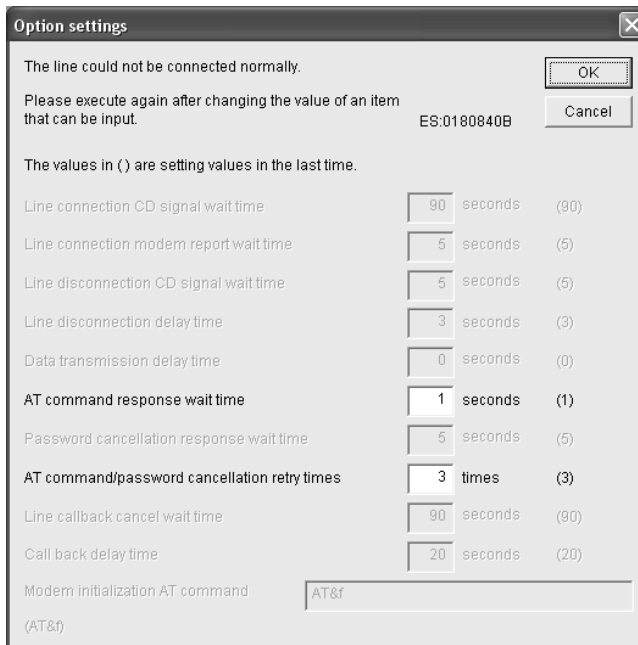

Change the waiting time and number of retries, and then click the [OK] button to close the dialog box.

Check the telephone number and AT command, and then execute connection again.

→ If line connection is disabled, refer to "Chapter 8. Troubleshooting".

10 Executing remote maintenance

Read and write sequence programs, and monitor devices.

11 Disconnecting the line

For disconnecting the line, select [Tools] - [Set TEL data] - [Disconnection] from the tool menu. When the following dialog box appears, click the [Yes] button to disconnect the line.

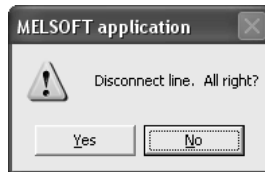

When line disconnection is finished, the following dialog box appears to indicate the connection destination telephone number and line use time.

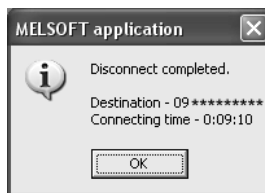

Click the [OK] button to close the dialog box.

A	Common Items
B	N:N Network
C	Parallel Link
D	Computer Link
E	Inverter Communication
F	Non-Protocol Communication (RS/RS2 Instruction)
G	Non-Protocol Communication (FX2N-232IF)
H	Programming Communication
I	Remote Maintenance

7.2.2 For FXGP/WIN

This subsection explains the line connection procedure using FXGP/WIN. Prepare for connection of the PLC, connect a modem to the communication port in the personal computer, and then start up FXGP/WIN.

1 Setting the modem to be used

Select [Remote] - [Environment] - [Modem] from the tool menu to display the following dialog box.

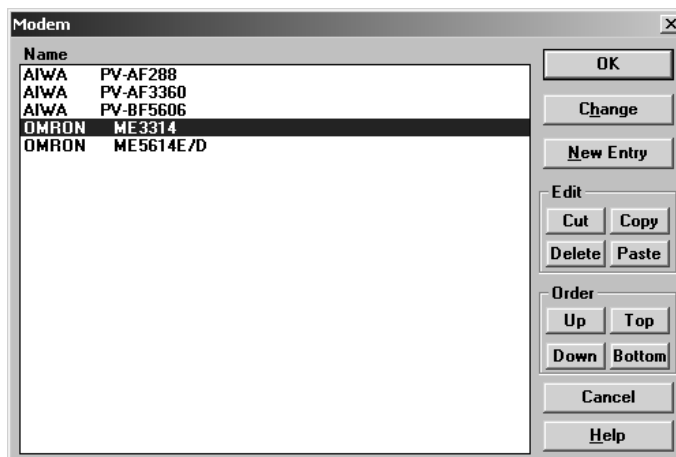

Select the modem to be used, and click the [OK] button.

If the modem to be used is not displayed, click the [New Entry] button, and register the AT command for the modem.

→ For details on AT command registration, refer to Subsection 6.2.1.

2 Connecting the connection destination

Select [Remote] - [Connect] - [to PLC] from the tool menu to display the following dialog box.

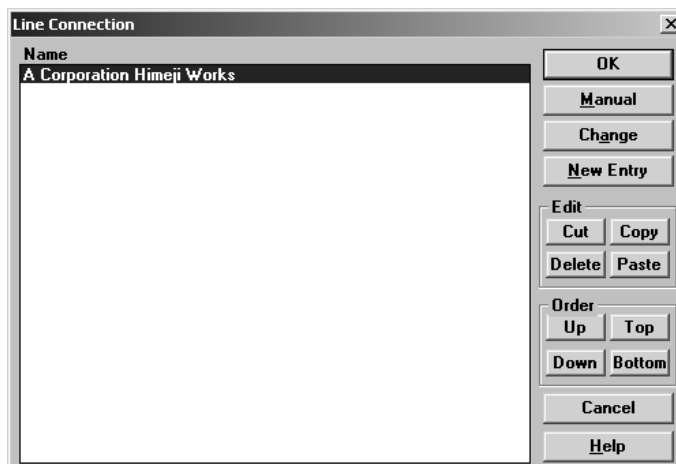

Select the connection destination, and click the [OK] button.

If the connection destination is not displayed, click the [New Entry] button, and register the connection destination.

→ For details on connection destination registration, refer to Subsection 6.2.2.

→ Proceed to the step 4.

When directly setting a telephone number, click the [Manual] button.

→ Proceed to the next step.

3 Executing manual connection

Click the [Manual] button to display the following dialog box.

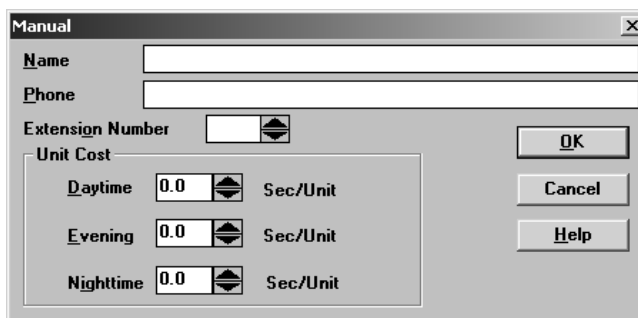

Set "Name" and "Phone", and click the [OK] button.

4 Checking the line connection status

When the [OK] button is clicked, the following dialog box appears.

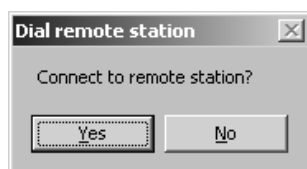

Click the [Yes] button to display the message box "Executing!" and make a call from the modem connected to the personal computer.

5 Checking the line connection status

1. When the line is connected

When connection is completed, the message box "Executing!" is closed, and the line connection time is displayed on the title bar as shown below:

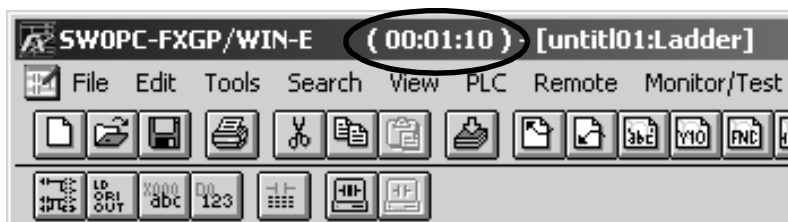

→ Proceed to the step 6.

2. When the line cannot be connected

When the line cannot be connected, the message box "Executing!" is closed, and the following dialog box appears.



Click the [OK] button to close the dialog box.

Check the telephone number and AT command, and then execute connection again.

→ If line connection is disabled, refer to "Chapter 8. Troubleshooting".

6 Executing remote maintenance

Read and write sequence programs, and monitor devices.

7 Disconnecting the line

For disconnecting the line, select [Remote] - [Disconnect] from the tool menu.
When the following dialog box appears, click the [Yes] button to disconnect the line.

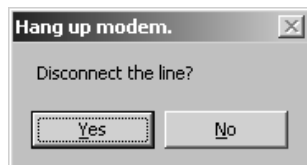

When the line is disconnected, the line connection time on the title bar disappears.



8. Troubleshooting

This chapter explains troubleshooting.

8.1 Checking FX PLC Applicability

Verify that the FX PLC main unit version is applicable to remote maintenance.
→ For the version applicability check, refer to Section 1.3.

8.2 Checking Programming Tool Applicability

Verify that the programming tool version is applicable to remote maintenance.
→ For the version applicability check, refer to Section 1.4.

FXGP/WIN cannot use remote maintenance when it is used in the following Windows:

- Windows NT4.0
- Windows 2000
- Windows XP

8.3 Checking Communication Status Based on LED Indication

Check the status of the "RXD (RD)" and "TXD (SD)" indicator LEDs provided in the optional equipment

LED status		Operation status
RXD (RD)	TXD (SD)	
Flashing	Flashing	Data is being sent or received.
Flashing	Off	Data is received, but is not sent.
Off	Flashing	Data is sent, but is not received
Off	Off	Data is not sent nor received.

When the power is turned ON, the FX PLC transfers the AT command to the connected modem. At this time, the "RXD (RD)" and "TXD (SD)" indicator LEDs in the communication equipment light instantaneously. If modem initialization is not set in parameters in the FX PLC, however, these LEDs do not light. If the wiring and/or modem specifications are different, these LEDs flash several times, but the FX PLC does not transfer the AT command.

8.4 Checking Installation

1. Mounting status

If the communication equipment is not securely connected to the PLC, communication is disabled.
→ For the mounting method, refer to the manual of each communication equipment.

8.5 Checking Modem Specifications

In a modem in which the following communication specifications are not applicable, remote maintenance can be used.

Check the modem specifications.

1. In the case of user registration mode

Item	Contents
Communication method	Half-duplex, asynchronous system
Baud rate	9600 bps
Start bit	1-bit
Data bit	7-bit
Parity bit	Even
Stop bit	1-bit
Control line	Not provided

2. PP modem mode (ch1) and PP modem mode (ch2)

Item	Contents
Communication method	Half-duplex, asynchronous system
Baud rate	9600 bps
Start bit	1-bit
Data bit	8-bit
Parity bit	Not provided
Stop bit	1-bit
Control line	Not provided

8.6 Checking Setting in PLC

Check the parameters, AT command and sequence programs in the PLC.

After changing any parameters, make sure to turn OFF the PLC power, and then turn it ON again.

8.6.1 Checking parameters in PLC

1. Checking the communication setting

Verify that non-protocol communication, computer link communication, etc. are not set in the parameters of the FX PLC. If such communication is already set, remote maintenance cannot be used.

2. Checking the modem initialization setting

Verify that the modem initialization is selected correctly in parameters in the FX PLC.

If the modem initialization is not set correctly, normal communication is disabled.

→ For the parameter settings of the PLC, refer to Chapter 5.

8.6.2 Checking AT command setting

The AT command is required when "user registration mode", "PP modem mode (ch 1)" or "PP modem mode (ch 2)" is selected in the modem initialization setting. When such a mode is set, check the following contents.

1. Checking data registers

The head device number and device range of data registers used for setting the AT command vary depending on the FX Series.

Check the data register numbers in which the AT command is set.

FX Series	Device range	FX Series	Device range
FX3U/FX3UC PLC	D1000 to D1059	FX2N/FX2NC PLC	D1000 to D1059
FX1N/FX1NC PLC	D1000 to D1059	FX1S PLC	D200 to D255

Use consecutive data registers from the head device number. If a numeric value is not set in a data register, the data registers after it are not transferred.

2. Checking the contents of the AT command

If the contents of the AT command are not correct, remote maintenance cannot be used.

Verify that the setting contents are correct.

As reference, the table below shows the set items and their contents of the AT commands registered in advance in PLCs.

Set item	PV-AF288 (AIWA)	ME3314B (OMRON)
	ATE0S0 = 2Q1&D0&M5\Q0\J0&W	ATE0S0 = 2Q1&D0&H0&R1S15=8&W
Command echo	E0 (not provided)	E0 (not provided)
Number of times of calling in automatic receiving	S0 = 2 (twice)	S0 = 2 (twice)
Result code display	Q1 (not provided)	Q1 (not provided)
DTR control	&D (normally ON)	&D (normally ON)
Communication mode	&M5 (V. 42 bis)	S15 = 8 (V. 42 bis)
Terminal flow control method	\Q0 (not provided)	&R1 (not provided)
Send data flow control	—	&H0 (not provided)
Terminal speed fixing mode	\J0 (fixed)	—
Writing to nonvolatile memory	&W	&W

3. Checking "CR (H0D)" and "LF (H0A)"

Make sure to input "CR (H0D)" and "LF (H0A)" at the end of the AT command. If they are not input, the AT command cannot be transferred.

→ For the AT command setting for the PLC, refer to Chapter 5.

8.6.3 Checking sequence program

1. Checking the contents of the communication setting

Verify that each device for the communication format (D8120), N:N Network (D8176 to D8180) and parallel link (M8070 and M8071) is used in a sequence program.

If each device is used in a sequence program, communication is not executed correctly.

2. Presence of VRRD and VRSC instructions (except FX3U and FX3UC PLCs)

Verify that VRRD and VRSC instructions are not used in a program.

If these instructions are used, delete them, turn OFF the PLC power, and then turn it ON again.

3. Presence of RS instruction (except FX3U and FX3UC PLCs)

Verify that RS instruction is not used in a program.

If this instruction is used, delete it, turn OFF the PLC power, and then turn it ON again.

4. Presence of RS and RS2 instructions (in FX3U and FX3UC PLCs)

Verify that RS and RS2 instructions are not used in the same channel.

If these instructions are used in the same channel, delete them, turn OFF the PLC power, and then turn it ON again.

5. Presence of EXTR instruction (in FX2N and FX2NC PLCs)

Verify that EXTR instruction is not used in a program.

If this instruction is used, delete it, turn OFF the PLC power, and then turn it ON again.

6. Presence of IVCK, IVDR, IVRD, IVWR, and IVBWR instructions (in FX3U and FX3UC PLCs)

Verify that IVCK, IVDR, IVRD, IVWR and IVBWR instructions are not used in the same channel.

If these instructions are used in the same channel, delete them, turn OFF the PLC power, and then turn it ON again.

8.7 Checking Setting in Programming Tool

Verify that the setting contents of the programming tool is correct.

1. Checking the telephone number

Verify that the telephone number of the connection destination is set correctly.

2. Checking the AT command setting

Verify that the AT command is set correctly for the registered modem.

3. Checking the communication port

Verify that the communication port connected to the modem is set correctly.

→ For the setting in the programming tool, refer to Chapter 6.

8.8 Checking Absence/Presence of Errors

In FX3U and FX3UC Series, an error occurs when modem initialization is disabled. Verify that an error has not occurred.

1. Checking M8063

When a communication error occurs, M8063 turns ON and D8063 stores the corresponding error code.

2. Checking the error code

D8063 stores either of the following error codes:

	Error code	Contents of error
D8063	6301	Parity error, overrun error or framing error
	6302	Defective communication character
	6303	Communication data sum mismatch
	6304	Defective data format
	6305	Defective command
	6306	Monitoring timeout
	6307	Modem initialization error
	6308	N:N Network parameter error
	6312	Parallel link character error
	6313	Parallel link sum error
	6314	Parallel link format error
	6320	Error in communication with inverter

When modem initialization is disabled, D8063 stores the error code 6307.

If D8063 stores any error code shown above, check the following items:

- Wiring
- Modem specifications

Warranty

Please confirm the following product warranty details before using this product.

1. Gratis Warranty Term and Gratis Warranty Range

If any faults or defects (hereinafter "Failure") found to be the responsibility of Mitsubishi occurs during use of the product within the gratis warranty term, the product shall be repaired at no cost via the sales representative or Mitsubishi Service Company. However, if repairs are required onsite at domestic or overseas location, expenses to send an engineer will be solely at the customer's discretion. Mitsubishi shall not be held responsible for any re-commissioning, maintenance, or testing on-site that involves replacement of the failed module.

[Gratis Warranty Term]

The gratis warranty term of the product shall be for one year after the date of purchase or delivery to a designated place. Note that after manufacture and shipment from Mitsubishi, the maximum distribution period shall be six (6) months, and the longest gratis warranty term after manufacturing shall be eighteen (18) months. The gratis warranty term of repair parts shall not exceed the gratis warranty term before repairs.

[Gratis Warranty Range]

- 1) The range shall be limited to normal use within the usage state, usage methods and usage environment, etc., which follow the conditions and precautions, etc., given in the instruction manual, user's manual and caution labels on the product.
- 2) Even within the gratis warranty term, repairs shall be charged for in the following cases.
 - a) Failure occurring from inappropriate storage or handling, carelessness or negligence by the user. Failure caused by the user's hardware or software design.
 - b) Failure caused by unapproved modifications, etc., to the product by the user.
 - c) When the Mitsubishi product is assembled into a user's device, Failure that could have been avoided if functions or structures, judged as necessary in the legal safety measures the user's device is subject to or as necessary by industry standards, had been provided.
 - d) Failure that could have been avoided if consumable parts (battery, backlight, fuse, etc.) designated in the instruction manual had been correctly serviced or replaced.
 - e) Relay failure or output contact failure caused by usage beyond the specified Life of contact (cycles).
 - f) Failure caused by external irresistible forces such as fires or abnormal voltages, and Failure caused by force majeure such as earthquakes, lightning, wind and water damage.
 - g) Failure caused by reasons unpredictable by scientific technology standards at time of shipment from Mitsubishi.
 - h) Any other failure found not to be the responsibility of Mitsubishi or that admitted not to be so by the user.

2. Onerous repair term after discontinuation of production

- 1) Mitsubishi shall accept onerous product repairs for seven (7) years after production of the product is discontinued.
Discontinuation of production shall be notified with Mitsubishi Technical Bulletins, etc.
- 2) Product supply (including repair parts) is not available after production is discontinued.

3. Overseas service

Overseas, repairs shall be accepted by Mitsubishi's local overseas FA Center. Note that the repair conditions at each FA Center may differ.

4. Exclusion of loss in opportunity and secondary loss from warranty liability

Regardless of the gratis warranty term, Mitsubishi shall not be liable for compensation of damages caused by any cause found not to be the responsibility of Mitsubishi, loss in opportunity, lost profits incurred to the user or third person by Failures of Mitsubishi products, special damages and secondary damages whether foreseeable or not, compensation for accidents, and compensation for damages to products other than Mitsubishi products, replacement by the user, maintenance of on-site equipment, start-up test run and other tasks.

5. Changes in product specifications

The specifications given in the catalogs, manuals or technical documents are subject to change without prior notice.

6. Product application

- 1) In using the Mitsubishi MELSEC programmable logic controller, the usage conditions shall be that the application will not lead to a major accident even if any problem or fault should occur in the programmable logic controller device, and that backup and fail-safe functions are systematically provided outside of the device for any problem or fault.
- 2) The Mitsubishi programmable logic controller has been designed and manufactured for applications in general industries, etc. Thus, applications in which the public could be affected such as in nuclear power plants and other power plants operated by respective power companies, and applications in which a special quality assurance system is required, such as for Railway companies or Public service purposes shall be excluded from the programmable logic controller applications.
In addition, applications in which human life or property that could be greatly affected, such as in aircraft, medical applications, incineration and fuel devices, manned transportation, equipment for recreation and amusement, and safety devices, shall also be excluded from the programmable logic controller range of applications.
However, in certain cases, some applications may be possible, providing the user consults their local Mitsubishi representative outlining the special requirements of the project, and providing that all parties concerned agree to the special circumstances, solely at the users discretion.

Revised History

Date	Revision	Discription
7/2005	A	First Edition
2/2006	B	<ul style="list-style-type: none">• The status of the DR (DSR) signal is made checkable when RS2 (serial data transfer 2) is in operation.• Parameters in A700 Series are added.• Clerical error is modified

USER'S MANUAL - Data Communication Edition

FX SERIES PROGRAMMABLE CONTROLLERS



HEAD OFFICE: TOKYO BUILDING, 2-7-3 MARUNOUCHI, CHIYODA-KU, TOKYO 100-8310, JAPAN
HIMEJI WORKS: 840, CHIYODA CHO, HIMEJI, JAPAN

MODEL	FX-U-COMMU-E
MODEL CODE	09R715