

# MITSUBISHI

## High Speed Counter Module Type A1SD61

### User's Manual

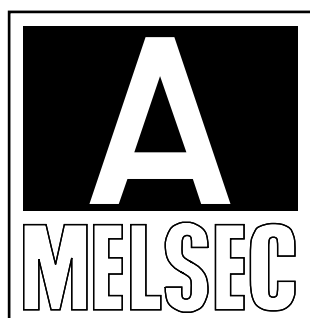
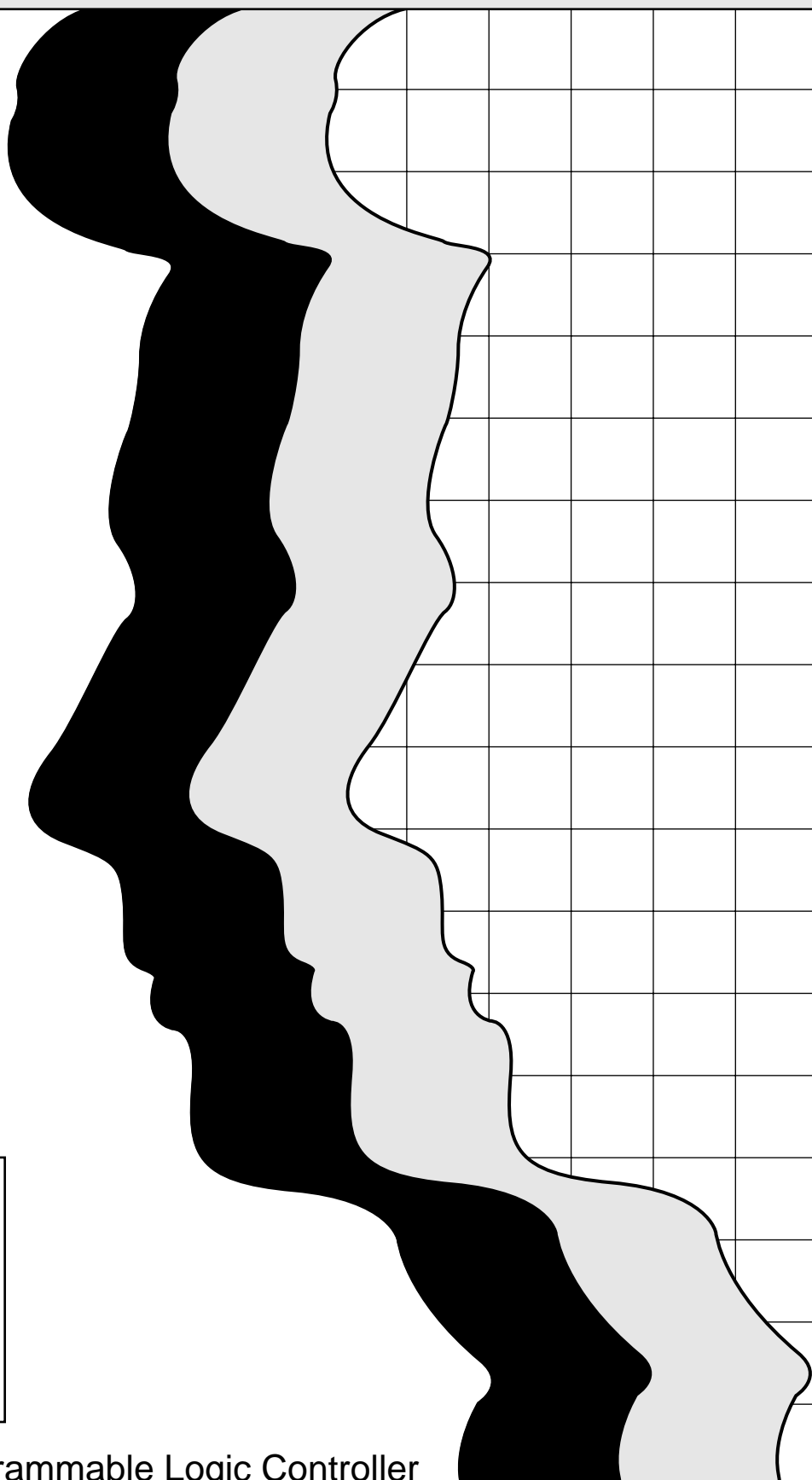

Mitsubishi Programmable Logic Controller



## ● SAFETY CAUTIONS ●

(You must read these cautions before using the product)

In connection with the use of this product, in addition to carefully reading both this manual and the related manuals indicated in this manual, it is also essential to pay due attention to safety and handle the product correctly.

The safety cautions given here apply to this product in isolation. For information on the safety of the PLC system as a whole, refer to the CPU module User's Manual.

These **SAFETY CAUTIONS** are classified into two grades: "DANGER" and "CAUTION".



Safety caution given when incorrect handling could result in hazardous situations involving the possibility of death or serious injury.



Safety caution given when incorrect handling could result in hazardous situations involving the possibility of moderate or light injury or damage to property.

Note that, depending on the circumstances, failing to follow a  **CAUTION** may also have very serious consequences.

Both of these classes of safety caution are very important and must be observed.

Store this manual carefully in a place where it is accessible for reference whenever necessary, and forward a copy of the manual to the end user.

[Cautions on Design]



**DANGER**

- An external output transistor failure may keep output ON or OFF. Add an external monitoring circuit for output signals whose incorrect execution could result in serious accidents.



**CAUTION**

- Use the PLC in the environment indicated in the general specifications of the manual.  
Using this PLC in an environment outside the range of the general specifications may cause electric shock, fire, malfunction, and damage to or deterioration of the product.
- Do not bundle control lines or communication wires together with main circuit or power lines, or lay them close to these lines.  
As a guide, separate the lines by a distance of at least 100 mm, otherwise malfunctions may occur due to noise.

[Cautions on Mounting]



**CAUTION**

- Do not touch any conductive part of the module directly.  
Doing so may cause malfunction or failure in the module.
- Mount the module after fully inserting the fixing projectin on the bottom of the module into the fixing hole in the base unit, and then tighten the module fixing screws to the specified torque.  
Not doing so can cause a malfunction, failure or drop of the module.

[Cautions on Wiring]



**CAUTION**

- Ground the shield wire to the encoder (relay box)(using class D (class 3) grounding or higher). Otherwise, malfunctioning will result.
- Carry out wiring to the PLC correctly, checking the rated voltage and terminal arrangement of the product.  
Using a power supply that does not conform to the rated voltage, or carrying out wiring incorrectly, will cause fire or failure.
- Input voltage in excess of the voltage set by the setting pin will cause failures.

[Cautions on Wiring]



**CAUTION**

- Tighten the terminal screws to the stipulated torque. Loose screws will cause short circuits, fire, or malfunctions. Overtightening may cause a short circuit or malfunctions due to a damaged screw.
- Make sure that no foreign matter such as chips or wiring offcuts gets inside the module. It will cause fire, failure or malfunction.

[Cautions on Startup and Maintenance]



**DANGER**

- Do not touch terminals while the power is ON. Doing so may result in an electric shock or malfunction.
- Be sure to shut off all phases of the external power supply before cleaning or retightening the terminal screws. Carrying out this work while the power is ON will cause failure or malfunction of the module.



**CAUTION**

- Do not disassemble or modify any module. This will cause failure, malfunction, injuries, or fire.
- Be sure to shut off all phases of the external power supply used by the system before mounting or removing the module. Mounting or removing it with the power ON can cause failure or malfunction of the module.
- Before handling the module, always touch grounded metal, etc. to discharge static electricity from the human body. Failure to do so can cause the module to fail or malfunction.

[Cautions on Disposal]



**CAUTION**

- Dispose of this product as industrial waste.

## REVISIONS

\*The manual number is given on the bottom left of the back cover.

Print Date	*Manual Number	Revision
Sep., 1991	IB (NA) 66337-A	First edition
Oct., 2002	IB (NA) 66337-B	<p><b>Partial correction</b></p> <p>CONTENTS, Chapter 2, Section 3.1, 3.2, 3.4, 3.5, 3.6, 4.2, 4.4.2, 4.4.3, 4.4.4, 5.1, 5.1.1, 5.1.2, 5.3, 7.1.1, 8.1.1, 9.1, 9.3, 9.4, 9.5</p> <p><b>Addition</b></p> <p>SAFETY PRECAUTIONS</p>
Nov., 2004	IB (NA) 66337-C	<p><b>Partial correction</b></p> <p>SAFETY PRECAUTIONS, Section 3.1, 9.1, 9.1.2, 9.2, 9.3, 9.4</p>

Japanese Manual Version SH-3519-F

This manual confers no industrial property rights or any rights of any other kind, nor does it confer any patent licenses. Mitsubishi Electric Corporation cannot be held responsible for any problems involving industrial property rights which may occur as a result of using the contents noted in this manual.

## **INTRODUCTION**

Thank you for purchasing the MELSEC-A series PLC.

Before using the equipment, please read this manual carefully to develop full familiarity with the functions and performance of the A series PLC you have purchased, so as to ensure correct use.

Please forward a copy of this manual to the end user.

# CONTENTS

<b>1. INTRODUCTION</b>	<b>1-1 ~ 1-2</b>
1.1 Features	1-2
<b>2. SYSTEM CONFIGURATION</b>	<b>2-1</b>
<b>3. SPECIFICATIONS</b>	<b>3-1 ~ 3-9</b>
3.1 General Specifications	3-1
3.2 Performance Specifications	3-2
3.3 Functions	3-3
3.4 External Devices Interfaces	3-4
3.5 I/O Signals from/to a PC CPU	3-5
3.6 Buffer Memory Assignment	3-7
3.7 Applicable Encoders	3-9
<b>4. INSTALLATION AND PRE-OPERATION SETTING PROCEDURE</b>	<b>4-1 ~ 4-7</b>
4.1 Pre-operation Setting Procedure	4-1
4.2 Handling Precautions	4-2
4.3 Part Names and Settings	4-3
4.4 Wiring	4-4
4.4.1 Wiring preconditions	4-4
4.4.2 Wiring example for the connection with the open collector output pulse generator	4-5
4.4.3 Wiring example for the connection of a controller to external input terminals (PRE-SET and F.START)	4-7
4.4.4 Wiring examples at external output terminals (OUTs 1 to 8)	4-7
<b>5. PULSE INPUT AND COUNTER PROCESSING METHOD</b>	<b>5-1 ~ 5-8</b>
5.1 Counting at 1-Phase Input	5-2
5.1.1 Counting using the phase A pulse input and decremental count command	5-3
5.1.2 Counting using the incremental phase A pulse input and the decremental phase B pulse input	5-4
5.2 Counting at 2-Phase Pulse Input	5-5
5.2.1 Counting using 2-phase pulse input multiplied by one	5-6
5.2.2 Counting using 2-phase pulse input multiplied by two	5-7
5.2.3 Counting using 2-phase pulse input multiplied by four	5-7
5.3 Reading the Present Value	5-8
<b>6. EXECUTING THE PRESET FUNCTION</b>	<b>6-1 ~ 6-8</b>
6.1 Preset Function	6-1
6.2 Preset Using the Sequence Program	6-2
6.2.1 Executing the preset function using the sequence program	6-2
6.2.2 Example program	6-3
6.3 Preset by External Input	6-6
6.3.1 When the preset is executed by external input	6-6



6.3.2	Example program .....	6-7
<b>7.</b>	<b>EXECUTING THE RING COUNTER FUNCTION .....</b>	<b>7-1 ~ 7-6</b>
7.1	Ring Counter Function .....	7-1
7.2	Example Program .....	7-5
<b>8.</b>	<b>EXECUTING THE LIMIT SWITCH OUTPUT FUNCTION .....</b>	<b>8-1 ~ 8-10</b>
8.1	Limit Switch Output Function .....	8-1
8.1.1	Example program .....	8-7
<b>9.</b>	<b>SELECTING AND EXECUTING THE COUNTER FUNCTION .....</b>	<b>9-1 ~ 9-17</b>
9.1	Selecting a Counter Function .....	9-1
9.1.1	Reading the counter value when executing the counter function selection ..	9-3
9.1.2	Count errors .....	9-4
9.2	Latch Counter Function .....	9-5
9.2.1	Example program .....	9-6
9.3	Sampling Counter Function .....	9-8
9.3.1	Example program .....	9-9
9.4	Periodic Pulse Counter Function .....	9-11
9.4.1	Example program .....	9-13
9.5	Count Disable Function .....	9-15
9.5.1	Example program .....	9-16
<b>10.</b>	<b>TROUBLESHOOTING .....</b>	<b>10-1 ~ 10-3</b>
10.1	Error Codes .....	10-1
10.2	RUN LED Flashes or OFF .....	10-2
10.3	Counter Value is Incorrect .....	10-3
10.4	Count Cannot be Made .....	10-3
<b>APPENDICES .....</b>	<b>APP-1 ~ APP-2</b>	
Appendix 1	COMPARING THE A1SD61 AND AD61 (S1) .....	APP-1
Appendix 2	EXTERNAL DIMENSIONS .....	APP-2

## 1. INTRODUCTION

This user's manual describes the specifications, handling, programming, etc. of the A1SD61 high speed counter module (hereinafter referred to as the A1SD61) that is used with the MELSEC-A series CPU module (hereinafter referred to as the PLC CPU) and counts pulses at the maximum counting speed of 50kpps.

The A1SD61 counts a 1-phase and 2-phase pulse input in the following way:

1-phase pulse input:

Counts the pulse at the rise;

2-phase pulse input multiplied by one:

Counts the pulse at the rise of phase A;

2-phase pulse input multiplied by two:

Counts the pulse at the rise/fall of phase A;

2-phase pulse input multiplied by four:

Counts the pulse at the rise/fall of phases A and B.

The following diagram shows how the A1SD61 works

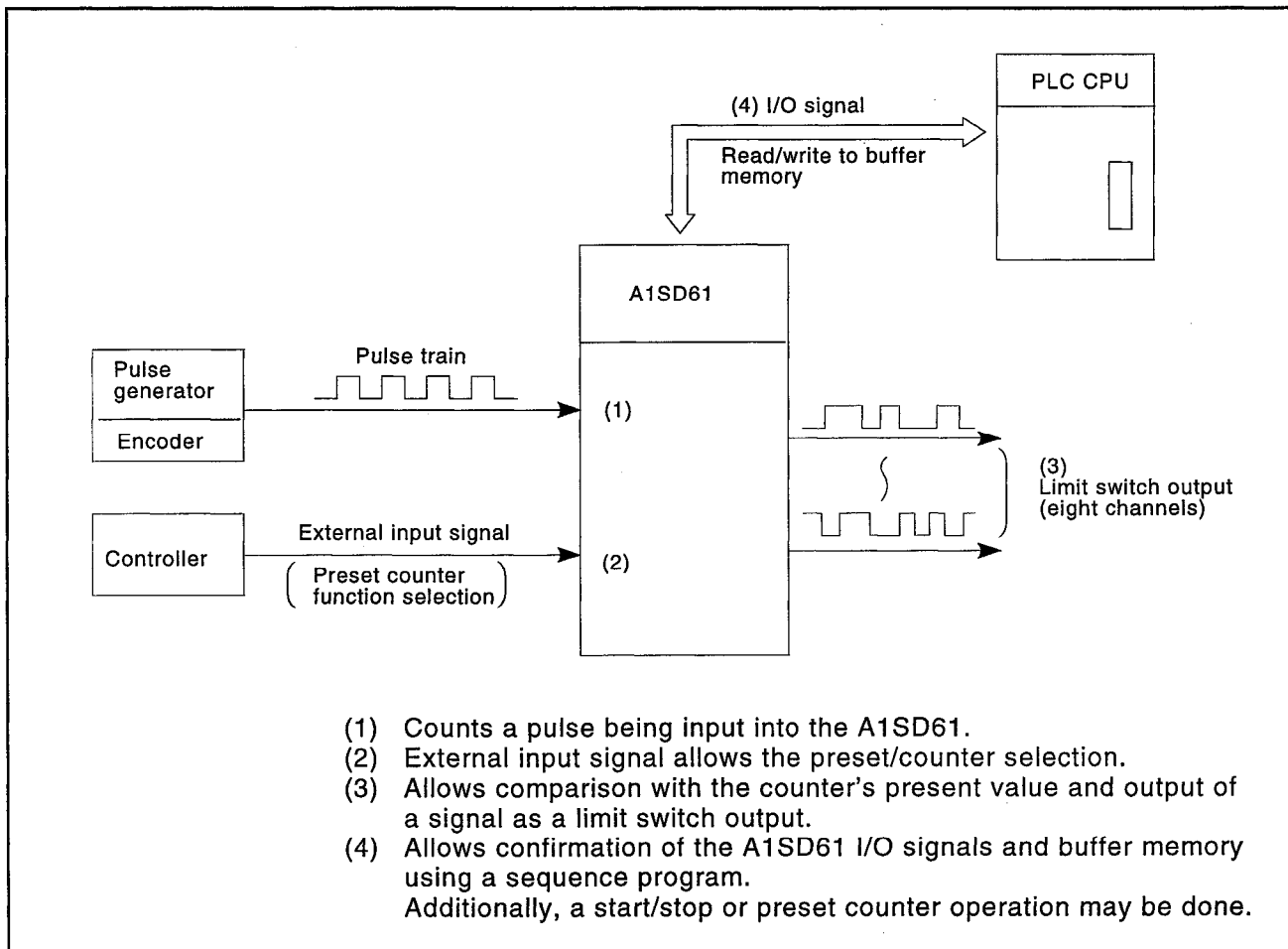

\*The functions of the A1SD61 differ from those of the AD61(S1).

Refer to Appendix 1.

## 1.1 Features

- (1) Pulses can be counted within a wide range, from -2147483648 to 2147483647

The count value is stored as a signed 32-bit data in binary code.

- (2) Count multiplication may be done (see Section 5).

When a 2-phase pulse is input, the count can be multiplied by either one, two, or four.

- (3) The maximum counting speed can be selected between 50 and 10k pps. (See Sections 3.2 and 4.3)

When the maximum counting speed is set to 50k pps, a pulse at a maximum of 50k pps can be counted in both the 1-phase and 2-phase inputs. When the maximum counting speed is set to 10k pps, a pulse at a maximum of 10k pps in the 1-phase input or at a maximum of 7k pps in the 2-phase input can be counted.

- (4) The ring counter function can be used (see Section 7).

This function allows pulses to be counted repeatedly between the preset value and ring counter value.

- (5) The limit switch output can be used (see Section 8).

The preset output status of a given channel is compared with the present value of the counter to output an ON/OFF signal.

- (a) A single module outputs to eight channels.
- (b) Four dogs can be used for each channel.

- (6) One out of the four counter functions can be selected (see Section 9)

Whichever function is desired from the following functions may be used:

- (a) Latch counter function
- (b) Sampling counter function
- (c) Periodic-pulse counter function
- (d) Count disable function

- (7) A function can be selected between the preset and the counter using the external input (see Sections 6.3 and 9)

By applying voltage to the PRESET (preset) /F.START (function start) external terminal, either the preset or the counter function can be used.

### 2. SYSTEM CONFIGURATION

#### (1) Applicable CPUs

- A1SJCPU(S3)
- A1SJHCPU(S8)
- A1SCPU(S1)
- A1SCPUC24-R2
- A1SHCPU
- A2SCPU(S1)
- A2SHCPU(S1)
- A2ASCPU(S1/S30)
- A2USHCPU-S1
- Q2ASCPU(S1)
- Q2ASHCPU(S1)
- A52GCPU(T21B)

#### (2) Number mountable

Any number of modules can be used, provided the number of I/O points of the applicable CPU is not exceeded.

#### (3) Available slots

The module can be installed to any slot in the base unit with the exception of the following cases.

When installing mounting modules in an extension base unit that does not have a power supply (A1S52B(S1), A1S55B(S1), A1S58B(S1)), the power supply capacity may be insufficient. Note that.

When installing an A1SD61 to the extension base unit that has no power supply module, select the power supply module, main base unit, extension base unit and extension cable after fully considering the following factors:

- 1) Current capacity of the power supply module on the main base unit
- 2) Voltage drop at the main base unit
- 3) Voltage drop at the extension base unit
- 4) Voltage drop in the extension cable

#### (4) Data link system

In a data link system, the module can be installed at a master station, local station, or remote I/O station. For an example of a remote I/O station program, refer to the MELSECNET, MELSECNET/B Data Link System Reference Manual.

#### **REMARK**

For Details on the ranges for the number of I/O points, and on calculating voltage drops, refer to the following manuals:

- Type A1SJCPU (S3) User's Manual ..... IB (NA)-66446
- Type A1S/A1SC24-R2/A2SCPU (S1) User's Manual..... IB (NA)-66320
- Type A2ASCPU (S1) User's Manual..... IB (NA)-66455
- A52GCPU(T21B) User's Manual ..... IB-66419
- A52GCPU(T21B) Reference Manual ..... IB-66420
- Type A1SJH(S8)/A1SH/A2SHCPU(S1) User's Manual..... IB-66779
- Type A2USHCPU-S1 User's Manual ..... IB-66789
- Model Q2AS(H)CPU(S1) User's Manual ..... SH-3599

3. SPECIFICATIONS

This section describes the general specifications of the A-series PC CPUs, performance specifications of the A1SD61, specifications of I/O signals to a PC CPU and buffer memory.

3.1 General Specifications

Table 3.1 gives the general specifications of the A-series PC CPUs.

Table 3.1 General Specifications

Item	Specifications				
Operating ambient temperature	0 to 55 °C				
Storage ambient temperature	-20 to 75 °C				
Operating ambient humidity	10 to 90% RH, non-condensing				
Storage ambient humidity	10 to 90% RH, non-condensing				
Vibration resistance	Conforming to JIS B 3502 and IEC 61131-2.	Under intermittent vibration			10 times in each of X, Y and Z directions (for 80 minutes)
		Frequency	Acceleration	Amplitude	
		10 to 57 Hz	—	0.075 mm (0.003 inch)	
		57 to 150 Hz	9.8m/s <sup>2</sup>	—	
		Under continuous vibration			
		Frequency	Acceleration	Amplitude	
		10 to 57 Hz	—	0.035 mm (0.001inch)	
57 to 150 Hz	4.9m/s <sup>2</sup>	—			
Shock resistance	Conforming to JIS B 3502 and IEC 61131-2. (147 m/s <sup>2</sup> , 3 times each of three in X, Y, Z directions)				
Operating ambience	The atmosphere shall not contain corrosive gas.				
Operating altitude *3	2000 m (6562 ft.) max.				
Installation location	Inside the control panel				
Overvoltage category *1	II or less				
Pollution level *2	2 or less				

\*1 Indicates the element in the distribution system between the public electricity grid and the mechanical equipment inside the premises that the relevant device is assumed to be connected to.

Category II applies to devices such as those that draw their power supply from fixed installations.

The surge voltage withstand capability of devices with ratings up to 300 V is 2,500 V.

\*2 This is an index which gives a measure of the incidence of conductive materials in the environment in which the device is used.

A contamination level of "2" indicates an environment in which there is only contamination by non-conducting materials, but, due to occasional condensation, conductivity may occur.

\*3 Do not use or store the PLC in the environment where the applied pressure is higher than the atmospheric pressure at the altitude of 0m. Doing so may cause a malfunction.

When using under such pressure, consult our representative in a branch.

### 3. SPECIFICATIONS

#### 3.2 Performance Specifications

Table 3.2 gives the performance specifications of the A1SD61.

**Table 3.2 Performance Specifications**

Item		Specifications												
Counting speed switching pin		50k	10k											
Number of I/O occupied points		32												
Number of channels		One												
Count input signal	Phase	1-phase and 2-phase inputs												
	Signal levels (øA and øB)	<table border="0"> <tr> <td>5 VDC</td> <td rowspan="3">} 2 to 5 mA</td> </tr> <tr> <td>12 VDC</td> </tr> <tr> <td>24 VDC</td> </tr> </table>		5 VDC	} 2 to 5 mA	12 VDC	24 VDC							
5 VDC	} 2 to 5 mA													
12 VDC														
24 VDC														
Counter	Maximum counting speed*	1-phase input	50k pps											
		2-phase input	7k pps											
	Counting range	32-bit signed binary -2147483648 to 2147483647												
	Type	Equipped with UP/DOWN preset counter and ring counter functions												
	Minimum pulse width that can be counted (Adjust so that the rise/fall time of the input is 5µ sec or less. Duty ratio: 50 %)													
Limit switch output	Comparison range	32-bit signed binary												
	Comparison result	A contact operation: dog ON address ≤ count value ≤ dog OFF address B contact operation: dog OFF address ≤ count value ≤ dog ON address												
External input	Preset	5/12/24 VDC												
	Function start	2 to 5 mA												
External output	Comparison output	Transistor (open collector) output 12/24 VDC 0.1 A/point 0.8 A/common												
Isolation specifications		<table border="1"> <thead> <tr> <th>Specific isolated area</th> <th>Isolation method</th> <th>Dielectric withstand voltage</th> <th>Insulation resistance</th> </tr> </thead> <tbody> <tr> <td>Between pulse input terminal and PLC power supply</td> <td rowspan="4">Photocoupler isolation</td> <td rowspan="4">500VAC for 1 minute</td> <td rowspan="4">5MΩ or more (measured with a 500V DC insulation resistance tester)</td> </tr> <tr> <td>Between preset input terminal and PLC power supply</td> </tr> <tr> <td>Between function start input terminal and PLC power supply</td> </tr> <tr> <td>Between coincidence output terminal and PLC power supply</td> </tr> </tbody> </table>		Specific isolated area	Isolation method	Dielectric withstand voltage	Insulation resistance	Between pulse input terminal and PLC power supply	Photocoupler isolation	500VAC for 1 minute	5MΩ or more (measured with a 500V DC insulation resistance tester)	Between preset input terminal and PLC power supply	Between function start input terminal and PLC power supply	Between coincidence output terminal and PLC power supply
Specific isolated area	Isolation method	Dielectric withstand voltage	Insulation resistance											
Between pulse input terminal and PLC power supply	Photocoupler isolation	500VAC for 1 minute	5MΩ or more (measured with a 500V DC insulation resistance tester)											
Between preset input terminal and PLC power supply														
Between function start input terminal and PLC power supply														
Between coincidence output terminal and PLC power supply														
Internal power consumption (5 VDC)		0.35 A												
Weight		0.27 kg												

### 3. SPECIFICATIONS

\* The counting speed is influenced by the pulse rise/fall time. The following counting speeds are possible. If a pulse is counted with a rise/fall time that is too long, a counter error may be caused.

Counting Speed Setting Pin	50k		10k	
	1-phase Input	2-phase Input	1-phase Input	2-phase Input
t=5μ sec or less	50k pps	50k pps	10k pps	7k pps
t=50μ sec or less	5k pps	5k pps	1k pps	700 pps
t=500 μ sec	—	—	500 pps	250 pps

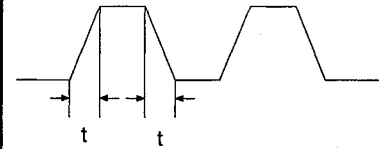

### 3.3 Functions

Table 3.3 gives the functions of the A1SD61.

**Table 3.3 Function Specifications**

Function	Description	Reference Section	
Preset	<ul style="list-style-type: none"> <li>Changes the present value of the counter.</li> <li>The preset operation can be done either by a sequence program or by an external preset input.</li> </ul>	6	
Ring counter	<ul style="list-style-type: none"> <li>Counting alternates between the preset value and the ring counter value.</li> </ul>	7	
Limit switch output	<ul style="list-style-type: none"> <li>Outputs an ON/OFF signal in a specified output status, comparing it with the present value of the limit switch output command counter.</li> </ul>	8	
Counter function selection	Latch counter	<ul style="list-style-type: none"> <li>Stores the present value of the counter when the signal of the counter function selection start command is input.</li> </ul>	9.2
	Sampling counter function	<ul style="list-style-type: none"> <li>After inputting the signal of the counter function selection start command, the input pulse is counted during a specified period and stored in the buffer memory.</li> </ul>	9.3
	Periodic pulse counter	<ul style="list-style-type: none"> <li>While inputting the signal of the counter function selection start command, the input pulses are stored in the buffer memory at specified intervals.</li> </ul>	9.4
	Count disable	<ul style="list-style-type: none"> <li>Stops counting pulses while the count enable command is ON.</li> </ul>	9.5

\* Counter function selection means that only one out of the four functions can be used.

### 3. SPECIFICATIONS

#### 3.4 External Devices Interfaces

Table 3.4 lists the external device interfaces.

Table 3.4 External Device Interfaces

Input/Output	Internal Circuit	Terminal No.	Signal Name	Operating Status	Input Voltage (Guaranteed Value)	Operating Current (Guaranteed Value)	
Input		1	Phase A pulse input 24V	ON	21.6 to 26.4 V	2 to 5 mA	
				OFF	5 V or lower	0.1 mA or lower	
			Phase A pulse input 12V	ON	10.8 to 13.2 V	2 to 5 mA	
				OFF	4V or lower	0.1 mA or lower	
			2	COM			
		3		Phase B pulse input 24V	ON	21.6 to 26.4 V	2 to 5 mA
					OFF	5 V or lower	0.1mA
				Phase B pulse input 12 V	ON	10.8 to 13.2 V	2 to 5 mA
	OFF		4V or lower	0.1mA or lower			
	4	Phase B pulse input 5 V	ON	4.5 to 5.5 V	2 to 5 mA		
		OFF	2 V or lower	0.1 mA or lower			
Input		5	Preset input 12 V/24 V	ON	10.2 to 26.4 V	2 to 6 mA	
				OFF	2 V or lower	0.1mA or lower	
			6	Preset input 5V	ON	4.5 to 5.5 V	3.5 to 5.5 mA
				OFF	1.5V or lower	0.1mA or lower	
Input		7	Function start input 24 V	ON	21.6 to 26.4 V	2 to 5 mA	
				OFF	5 V or lower	0.1 mA or lower	
			Function start input 12V	ON	10.8 to 13.2 V	2 to 5 mA	
				OFF	4 V or lower	0.1 mA or lower	
			8	Function start input 5V	ON	4.5 to 5.5 V	2 to 5 mA
				OFF	2 V or lower	0.1 mA or lower	
Output		11	OUT 1	Operating voltage: 10.2 to 30 V Rated current: 0.5 A Rated voltage: 0.1 A/point 0.8 A/common Maximum rush current: 0.6 A 10 msec Maximum voltage drop at ON: 0.7 V(TYP) *2 1.3 V(MAX) Response time OFF → ON: 1 msec (MAX) 0.3 msec (MIN) ON → OFF 1 msec (MAX) 0.3 msec (MIN)			
		12	OUT 2				
		13	OUT 3				
		14	OUT 4				
		15	OUT 5				
		16	OUT 6				
		17	OUT 7				
		18	OUT 8				
		19	12/24V				Input voltage: 10.2 to 30 V
		20	0V				Current consumption: 8 mA (TYP 24 VDC)

\*1 In the preset input and function start input, the same external input voltage setting pin is used.

\*2 The response time includes the internal processing time. It is the time from data detection till its output to the outside.



### 3. SPECIFICATIONS

#### 3.5 I/O Signals from/to a PLC CPU







Tables 3.5 and 3.6 list the I/O signals from/to a PLC CPU.

The I/O numbers (X, Y) and I/O addresses which are referred to in this manual are used when the A1SD61 is loaded to I/O slot 0 of a main base unit.

**Table 3.5 Input Signals**

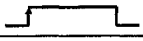
Input Signal	Name PLC CPU ← A1SD61	Description	Reference Section
X00	Watchdog timer error flag	Goes ON when a watchdog timer error occurs in the A1SD61.	—
X01	CH1 limit switch output status flag	Goes ON or OFF simultaneously with a limit switch output. All channels are OFF when the limit switch command (Y15) is OFF.	8.1
X02	CH2 limit switch output status flag		
X03	CH3 limit switch output status flag		
X04	CH4 limit switch output status flag		
X05	CH5 limit switch output status flag		
X06	CH6 limit switch output status flag		
X07	CH7 limit switch output status flag		
X08	CH8 limit switch output status flag		
X09	Limit switch output enable flag	Goes ON when the limit switch is enabled.	
X0A	External preset command detection flag	Goes ON when the preset command (applied voltage) reaches the PRESET terminal. Goes OFF when the external command detection reset command (Y16) is turned ON.	6.3
X0B	Error flag	Goes ON when the write setting value contains an error. Stores the error code to the buffer memory (address 11) which is used for write data error code storage when the error flag is turned ON.	—
X0C	Fuse/external power cutoff detection flag	Goes ON when the fuse to the limit switch output part blew or when no power is supplied to the OUT terminal.	—
X0D	Sampling/periodic counter flag	Goes ON when a sampling/periodic counter function is used.	9.3 9.4
X0E to X1F	—	Unusable	—

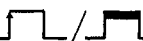
Table 3.6 Output Signals

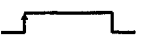
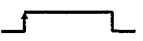
Output Signal	Name PLC CPU → A1SD61	Operating Timing	Description	Reference Section
Y00 to Y0F	—	—	Unusable	—
Y10 *1	Count enable command		Counts pulses.	—
Y11 *1	Decrement count command		Counts pulses by subtracting the pulsed when this signal is ON. This signal is valid only when a 1-phase pulse is input. However, this signal cannot be used along with an external input(øB).	5.1.1
Y12 *2	Preset command		Executes the preset operation.	6.2.1
Y13 *1	Ring counter command		Starts the ring counter.	7.1
Y14 *1 *2	Counter function selection start command		Selects the counter function.	9.2 9.3 9.4 9.5
Y15 *1	Limit switch output command		Enables the limit switch output (8 channels in batch).	8,1
Y16 *1	External preset command detection reset command		Turns OFF the external preset command detection flag (X0A).	6.3.1
Y17 *2	Error reset command		Resets the error code. Turns OFF the error flag (X0B) at the same time.	—
Y18 to Y1F	—	—	Unusable	—

**REMARK**

(1) In table 3.6, the operating timings (  ,  ) become valid in the following cases:

\*  : Valid when the signal is ON.

\*  : Valid when the signal is at rise (OFF → ON).

**POINT**

\*1 Use the OUT instruction while the signal is ON.

\*2 Use the PLS instruction when the signal is at rise.

When the SET/RST instruction is used to turn ON/OFF the output signal (Y10 to 17), it may not function normally unless the ON time is 1.5ms or longer.

#### 3.6 Buffer Memory Assignment

Table 3.7 shows the buffer memory assignment (without battery backup) of the A1SD61.

Table 3.8 gives detailed information about the settings of the addresses from 12 to 147 of the buffer memory.

Initial values are set in the buffer memory when power to the A1SCPU is ON or when the PLC CPU is reset.

The contents in the buffer memory can be read/written using a FROM/TO instruction in a sequence program of the PLC CPU.

**POINT**

Among various processings of the special function module, access from the PLC CPU is processed with priority.

Therefore, frequent access from the PLC CPU to the special function module buffer memory not only increases the scan time of the PLC CPU but also causes delays in various processings of the special function module.

Access from the PLC CPU to the buffer memory with instructions such as FROM/TO should be made only when necessary.

**Table 3.7 Buffer Memory Assignment**

Address	Setting Contents	Initial Value	Read/write	Reference Section	
0	Present value	(L)	Read only	5.3	
1		(H)			
2	Counter function selection count value	(L)		0	9.1.1
3		(H)			
4	Pulse input mode setting	0	Read/write possible	5	
5	Counter function selection setting	0		9.1	
6	Preset value setting	(L)		0	6.2.1 6.3.1
7		(H)			
8	Ring counter value setting	(L)		1024	7.1
9		(H)			
10	Sampling/periodic time setting	1		9.3 and 9.4	
11	Write data error code	0		10.1	
12 to 28	CH1 limit switch output data setting	0	Read/write possible	8.1 (table 3.8)	
29 to 45	CH2 limit switch output data setting	0			
46 to 62	CH3 limit switch output data setting	0			
63 to 79	CH4 limit switch output data setting	0			
80 to 96	CH5 limit switch output data setting	0			
97 to 113	CH6 limit switch output data setting	0			
114 to 130	CH7 limit switch output data setting	0			
131 to 147	CH8 limit switch output data setting	0			

### 3. SPECIFICATIONS

**Table 3.8 Details for Buffer Memory Addresses 12 to 147 (Limit Switch Output Data Setting of CH1 to CH8)**

Setting Contents	Buffer Memory Address								
	12 to 28 CH1	29 to 45 CH2	46 to 62 CH3	63 to 79 CH4	80 to 96 CH5	97 to 113 CH6	114 to 130 CH7	131 to 147 CH8	
Number of multi-dogs of CH[ ]	12	29	46	63	80	97	114	131	
ON address of dog 0 of CH[ ]	(L)	13	30	47	64	81	98	115	132
	(H)	14	31	48	65	82	99	116	133
OFF address of dog 0 of CH[ ]	(L)	15	32	49	66	83	100	117	134
	(H)	16	33	50	67	84	101	118	135
ON address of dog 1 of CH[ ]	(L)	17	34	51	68	85	102	119	136
	(H)	18	35	52	69	86	103	120	137
OFF address of dog 1 of CH[ ]	(L)	19	36	53	70	87	104	121	138
	(H)	20	37	54	71	88	105	122	139
ON address of dog 2 of CH[ ]	(L)	21	38	55	72	89	106	123	140
	(H)	22	39	56	73	90	107	124	141
OFF address of dog 2 of CH[ ]	(L)	23	40	57	74	91	108	125	142
	(H)	24	41	58	75	92	109	126	143
ON address of dog 3 of CH[ ]	(L)	25	42	59	76	93	110	127	144
	(H)	26	43	60	77	94	111	128	145
OFF address of dog 3 of CH[ ]	(L)	27	44	61	78	95	112	129	146
	(H)	28	45	62	79	96	113	130	147

[ ] indicates a channel number.

#### 3.7 Applicable Encoders

The encoders applicable to the A1SD61 are shown below:

- (1) Open-collector type
- (2) CMOS output type

(Make sure that the output voltage of the encoder complies with the A1SD61 specifications.)

**POINT**

The following types of encoders cannot be used with the A1SD61:

- TTL output type
- Line drive output type

# 4. INSTALLATION AND PRE-OPERATION SETTING PROCEDURE MELSEC-A

## 4. INSTALLATION AND PRE-OPERATION SETTING PROCEDURE

This section describes the pre-operation procedure of the A1SD61, the names and settings of each part of the A1SD61, and the wiring method.

### 4.1 Pre-operation Setting Procedure

The pre-operation setting procedure of the A1SD61 is shown below:

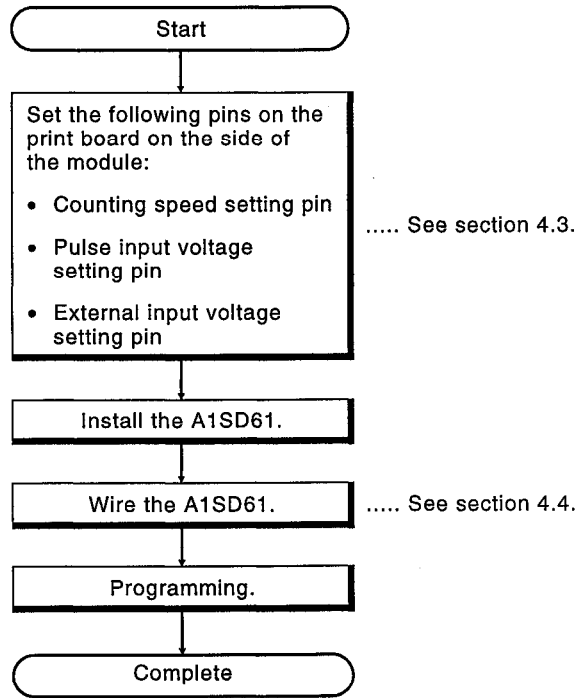

# 4. INSTALLATION AND PRE-OPERATION SETTING PROCEDURE MELSEC-A

## 4.2 Handling Precautions

Handling precautions for the A1SD61 are given below:

- (1) Protect the case and the terminal block from impact, since they are made from resin.
- (2) Do not remove the printed circuit board from the case. Doing so can cause a failure.
- (3) When wiring, make sure that no wire offcuts remain around the terminal block. Remove foreign matter if it has entered.
- (4) Tighten the module mounting screws and terminal screws within the following ranges.

Screw Location	Tightening Torque Range
Module mounting screw (M4 screw)	78 to 118 N•cm
Terminal block terminal screw (M3.5 screw)	59 to 88 N•cm
Terminal block mounting screw (M4 screw)	78 to 118 N•cm

- (5) Install the module on the base unit by engaging the module locking tabs in the module locking holes in the base unit and tightening the module mounting screws. To remove the module from the base unit, unfasten the module mounting screws, then disengage the module locking tabs from the module locking holes.

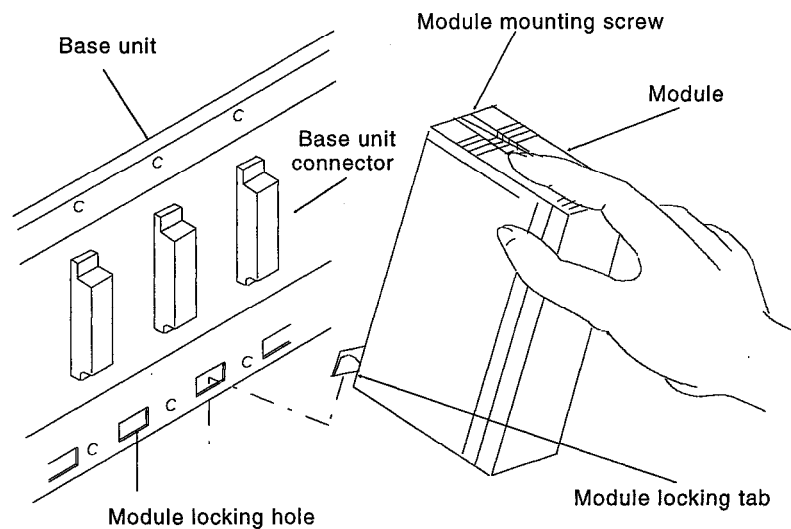

# 4. INSTALLATION AND PRE-OPERATION SETTING PROCEDURE MELSEC-A

## 4.3 Part Names and Settings

The names of each part of the A1SD61 and the settings are shown below:

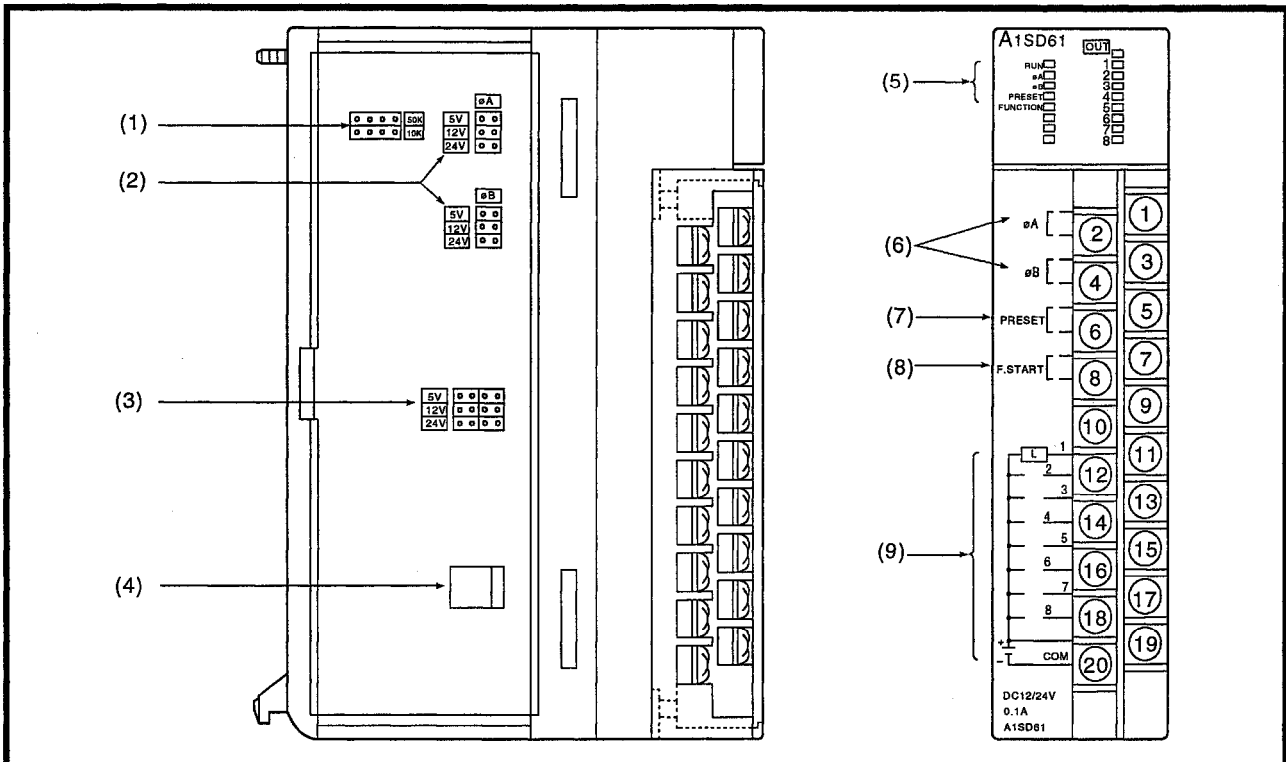

No.	Name	Description
(1)	Counting speed setting pin	50k: Counts pulses at a maximum speed of 50k pps in 1-phase or 2-phase input. 10k: Counts pulses at 10k pps in 1-phase input, at 7k pps in 2-phase input. (The factory-setting is 50k.) (Set using a jumper)
(2)	Pulse input voltage setting pin	Sets the pulse voltage that is input to Phase A or B. (The factory-setting is 24 V.) Mitsubishi cannot guarantee the module when a pulse whose voltage is higher than the set voltage is applied. (Set using a jumper) (See section 3.4.)
(3)	External input voltage setting pin	Sets the voltage input to the PRESET/F.START terminals. (The factory-setting is 24 V.) Mitsubishi cannot guarantee the module when a pulse whose voltage is higher than the set voltage is applied. (Set using a jumper) (See section 3.4.)
(4)	Fuse	Used for protecting OUTs 1 to 8 from overcurrent. (soldered-to-board type)
(5)	LED indicators	RUN Lit when the module operates normally. Flashes when a data write error has occurred. OFF when a watchdog timer error has occurred.
		φA Lit when voltage is applied to phase A pulse input terminal.
		φB Lit when voltage is applied to phase B pulse input terminal.
		PRESET Lit and latched when voltage is applied to the PRESET terminal. OFF when external preset detection reset signal (Y16) is turned ON.
		FUNCTION ON when voltage is applied to the F. START terminal.
	OUTs 1 to 8	ON when a corresponding limit switch is turned ON by the limit switch output function. OFF when the limit switch is turned OFF.
(6)	φA/φB	Pulse input terminals (φB is used as decrement count command.)
(7)	PRESET	The terminal in which voltage is applied when a preset is executed from an external device.
(8)	F.START	The terminal in which voltage is applied when a counter function selection is executed.
(9)	OUTs 1 to 8	An external output terminal used for limit switch output.



# 4. INSTALLATION AND PRE-OPERATION SETTING PROCEDURE MELSEC-A

## 4.4 Wiring

Details on how to wire a pulse generator device to the A1SD61 are described below:

### 4.4.1 Wiring preconditions

The preconditions when a pulse generator device is wired to the A1SD61 are described below:

- (1) For a high-speed pulse input, take the following counter measures against noise:
  - (a) Be sure to use shielded twisted pair cables. Also, make sure it is grounded to Class 3 specifications.
  - (b) Do not run a twisted pair cable in parallel with power cables or other I/O lines which may generate noise. Run cables at least 150 mm (5.91 in.) away from the above-mentioned lines and over the shortest distance possible.
- (2) For 1-phase input, connect count input signal to phase A only.
- (3) If the A1SD61 picks up pulse noise, it will count incorrectly.
- (4) The specific measures against noise are shown below:

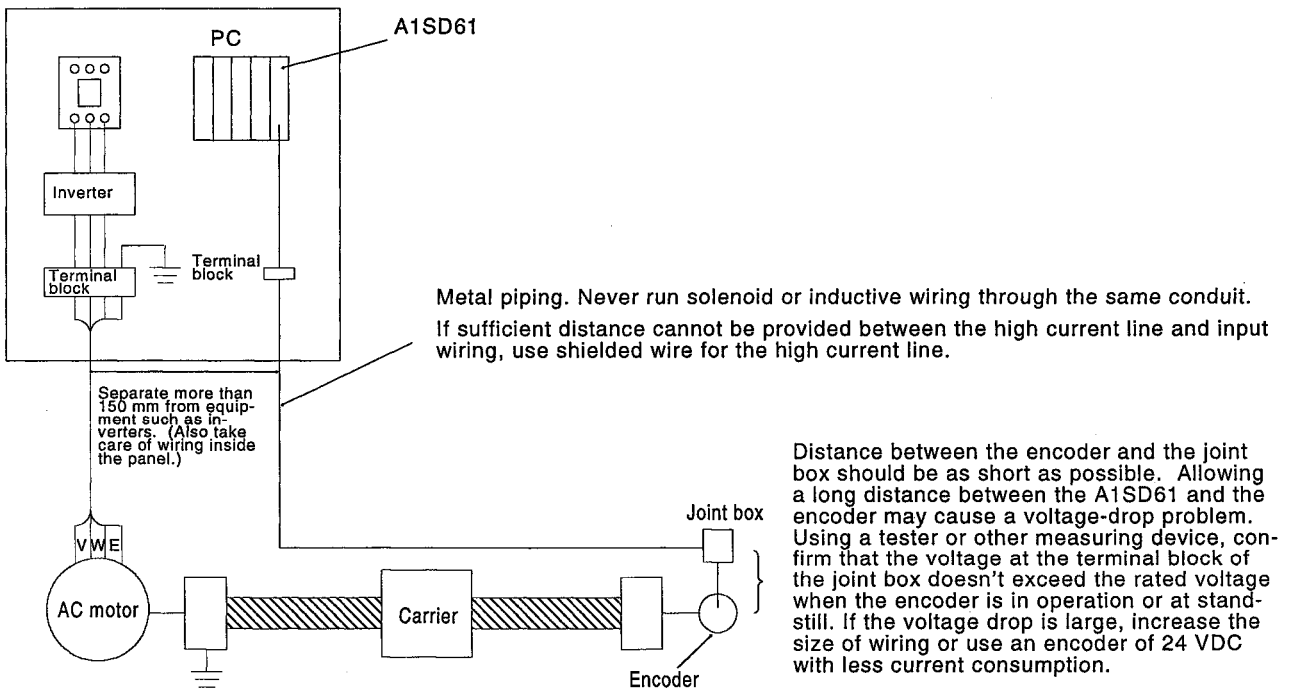

- Ground twisted shielded wire on the encoder side (joint box). (This is a connection example for 24 V send load.)

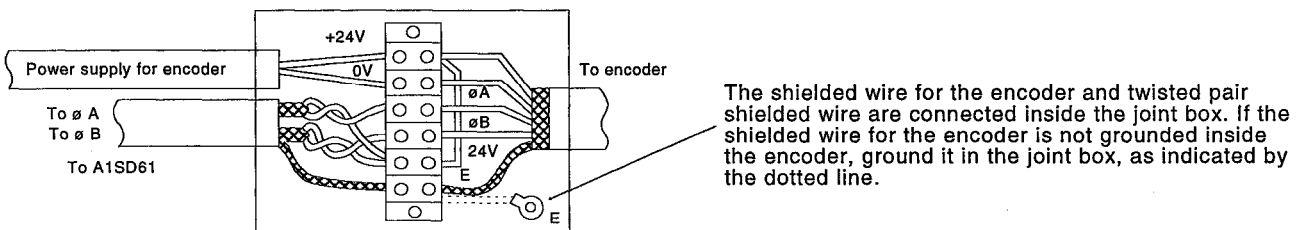

The shielded wire for the encoder and twisted pair shielded wire are connected inside the joint box. If the shielded wire for the encoder is not grounded inside the encoder, ground it in the joint box, as indicated by the dotted line.

# 4. INSTALLATION AND PRE-OPERATION SETTING PROCEDURE MELSEC-A

## 4.4.2 Wiring example of module and pulse generator

(1) Wiring example for connection with open collector output type pulse generator (24VDC)

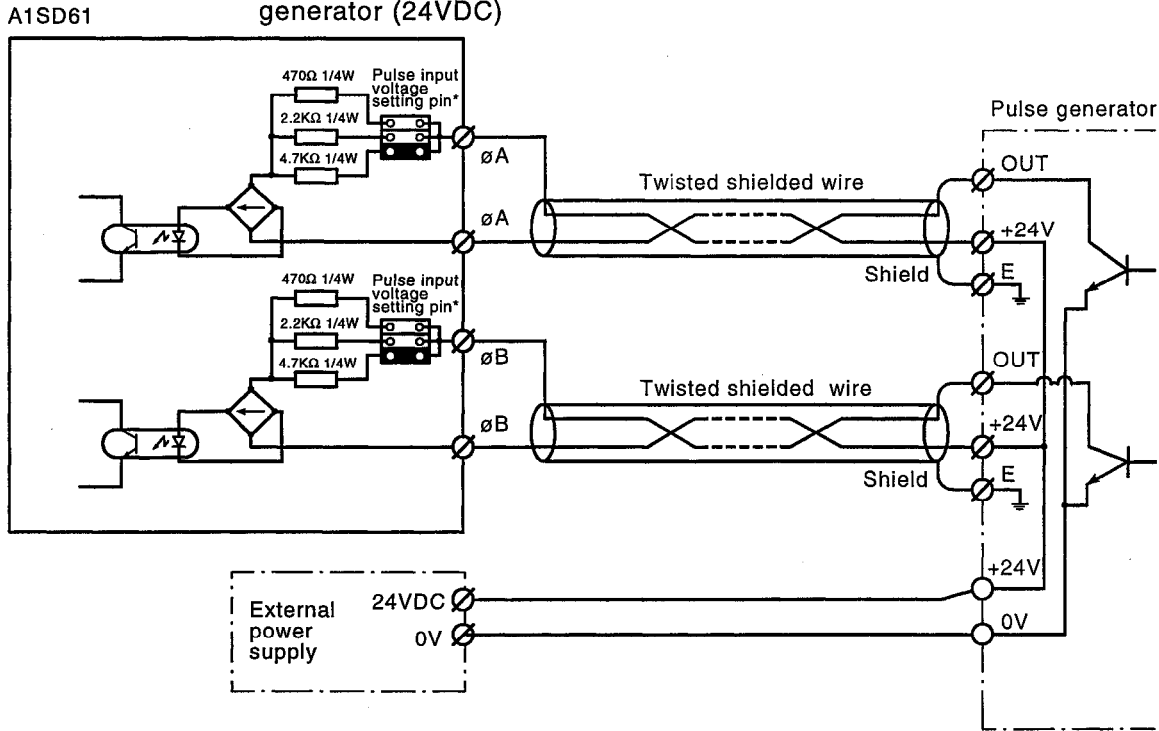

**POINT**

For the wiring of the A1SD61 and encoder, separate the power supply cable from signal cable. An example is shown below.

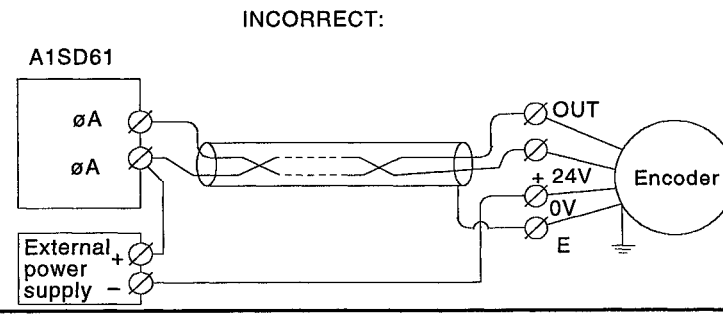
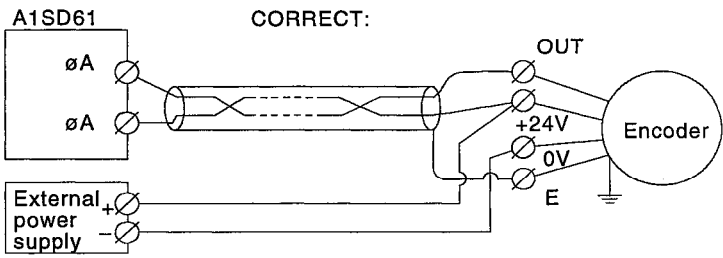

Since currents flow in the twisted pair cable in the same direction, a canceling effect is lost and the module becomes susceptible to electromagnetic induction.

**REMARK**

(1) \* Set the pulse input voltage setting pin to the position.

# 4. INSTALLATION AND PRE-OPERATION SETTING PROCEDURE MELSEC-A

## (2) Connection of a voltage output pulse generator (5 VDC)

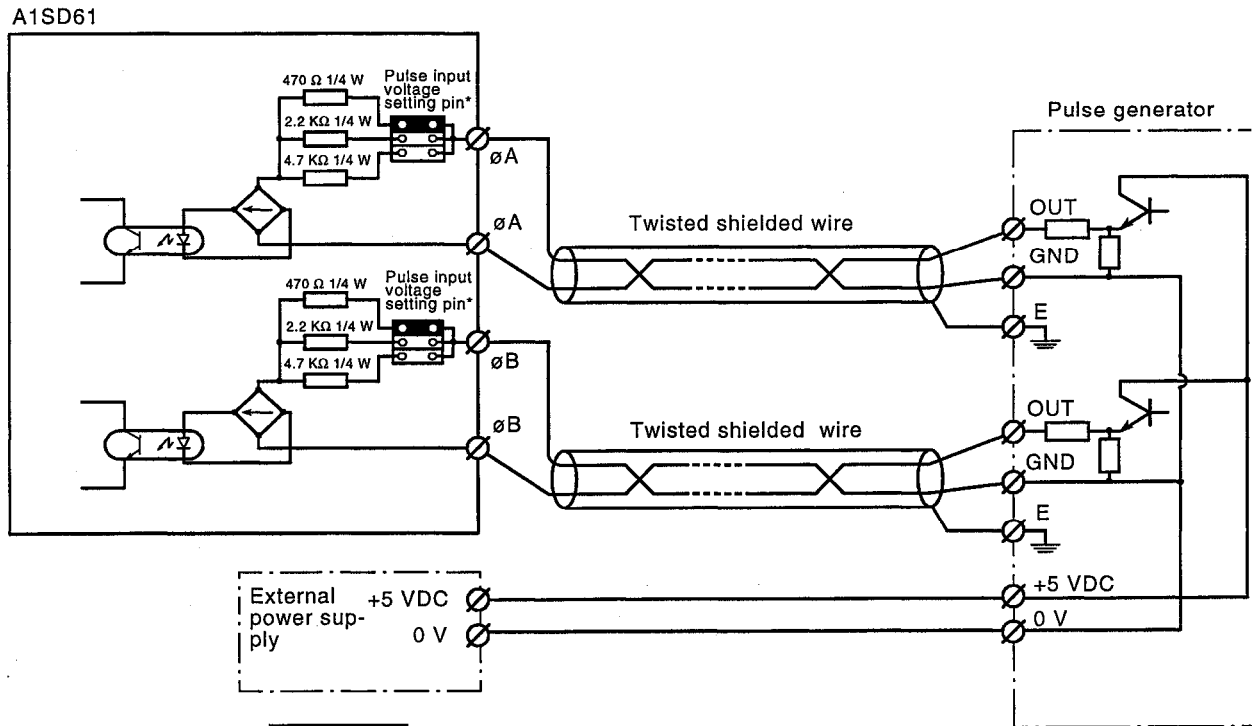

**REMARK**

(1) \* Set the pulse input voltage setting pin to the ●● position.

# 4. INSTALLATION AND PRE-OPERATION SETTING PROCEDURE MELSEC-A

## 4.4.3 Wiring example for the connection of a controller to external input terminals (PRESET and F.START)

(1) When a controller (sink load type) is supplied with 12 V:

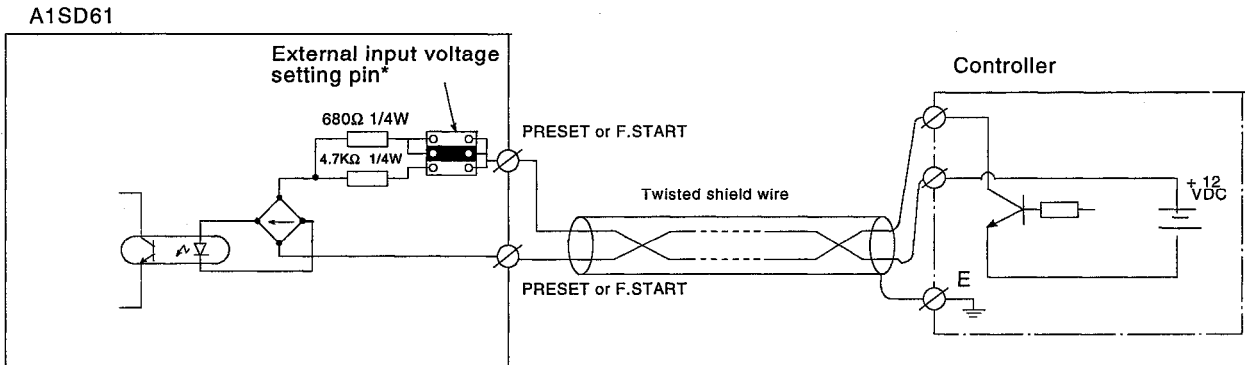

This diagram assumes that the internal circuit is set to PRESET.

(2) When a controller (source load type) is supplied with 5 V:

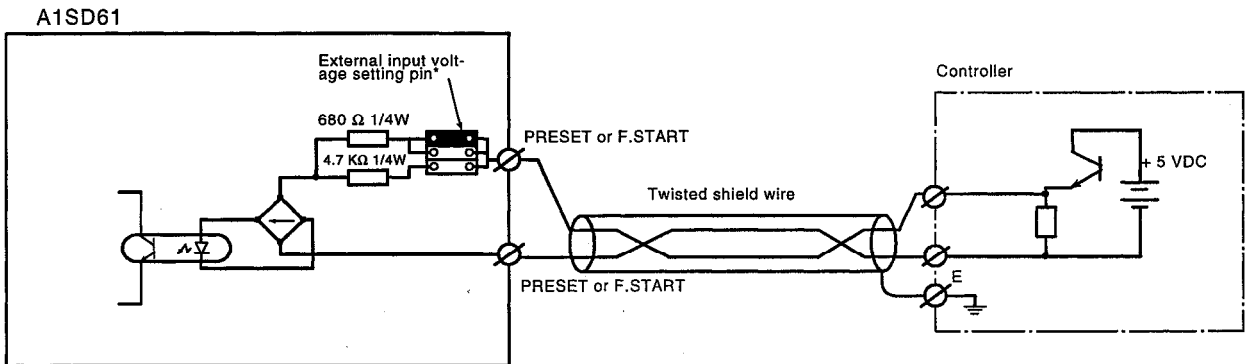

This diagram assumes that the internal circuit is set to PRESET.

### REMARK

(1) \* Set the external input voltage setting pin to the  position.

## 4.4.4 Wiring examples at external output terminals (OUTs 1 to 8)

To use an OUT terminal, the internal photocoupler should be activated. For this example, 10.2 to 30 VDC external power is necessary. Connection methods are as follows:

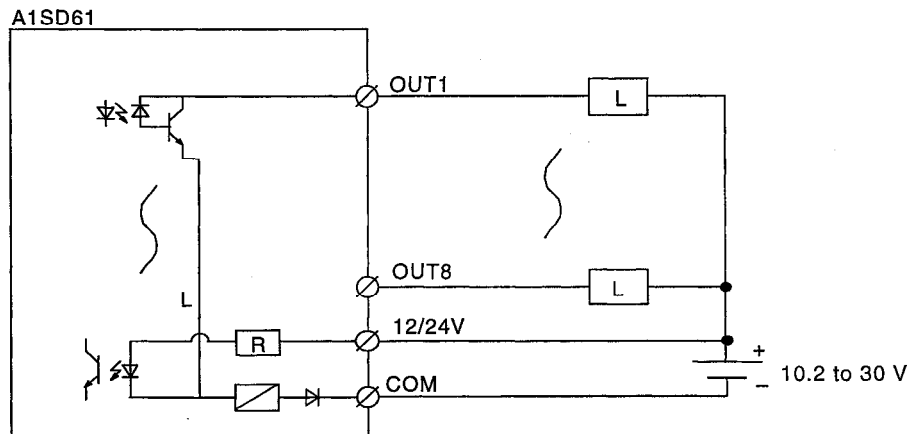

### 5. PULSE INPUT AND COUNTER PROCESSING METHOD

This section describes the pulse input and counter processing method.

(1) Either 1-phase or 2-phase pulse input may be executed.

(a) 1-Phase pulse input

When the 1-phase pulse input is executed, the following counts can be made:

- 1) Counts the phase A pulse inputs incrementally and counts the pulses by the decremental count command.
- 2) Counts the phase A pulse inputs incrementally and counts phase the B pulse inputs decrementally.

(b) 2-Phase pulse input

When the 2-phase pulse input is executed, the following counts can be made:

- 1) Multiplied by one: Counts phase A pulses at the rise.
- 2) Multiplied by two: Counts phase A pulses both at the rise and at the fall.
- 3) Multiplied by four: Counts phase A/B pulses both at the rise and at the fall.

(2) When 1-phase pulse input is done, the pulses are counted at rise.

(3) When the pulse input mode is changed, the count is made from "0".

## 5. PULSE INPUT AND COUNTER PROCESSING METHOD

MELSEC-A

### 5.1 1-Phase Pulse Input

At 1-phase pulse input, either "counting using the phase A pulse input and decremental count command" or "counting using the incremental phase A pulse input and the decremental phase B pulse input" can be selected.

- (1) For the relationship between the phase A pulse input and phase B pulse input, refer to Section 5.1.1 and 5.1.2.
- (2) Setting of counting method

When using the counting method, set 0 or 1 to the pulse input mode setting buffer memory (address 4) of the A1SD61 in the sequence program.

Counting Method	Set Value
Counting using the phase A pulse input and decremental count command	0
Counting using the incremental phase A pulse input and the decremental phase B pulse input	1

[Sequence program]

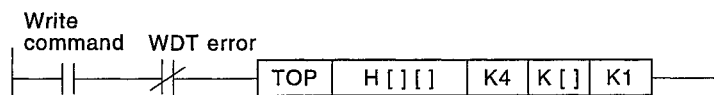

#### REMARK

- 1) In [[]], set the first two digits of the 3-digit head I/O number in hexadecimal notation assigned to the A1SD61.
- 2) In [], set 0 or 1.

# 5. PULSE INPUT AND COUNTER PROCESSING METHOD

MELSEC-A

## 5.1.1 Counting using the phase A pulse input and decremental count command

The following counts can be made using the incremental phase A pulse input and decremental count command:

- Incrementally counts the pulses that are input to phase A at the rise.
- Decrementally counts pulses when the decremental count command (voltage applied to phase B or Y11 turned ON by the PLC CPU) is input at the rise of a pulse input to phase A.

### (1) Incremental count

When an incremental count is executed, the operation timing of the pulse inputs, decremental count command, and the present value of the storage buffer memory are shown below:

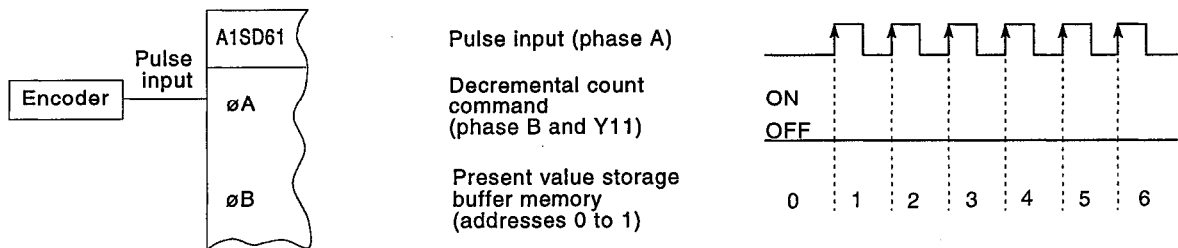

### (2) Decremental count

When a decremental count is executed, the operation timing of pulse inputs, decremental count command, and the present value of the storage buffer memory are shown below:

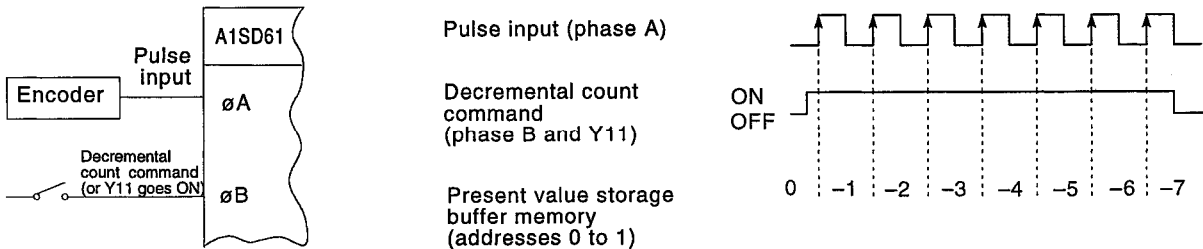

#### POINT

When the decremental count command is executed, apply voltage to phase B or turn ON Y11.

## 5. PULSE INPUT AND COUNTER PROCESSING METHOD

MELSEC-A

### 5.1.2 Counting using the incremental phase A pulse input and the decremental phase B pulse input

The following counts can be made using the incremental phase A pulse input and the decremental phase B pulse input:

- Incrementally counts the pulses that are input to phase A at the rise.
- Decrementally counts the pulses that are input to phase B at the rise.
- Subtracts the number of incremental pulses from the number of decremental pulses when the pulses are input to both phases A and B.

#### (1) Incremental count

When an incremental count is made, the operation timings of the incremental and decremental pulse inputs, and the present value of the storage buffer memory are shown below:

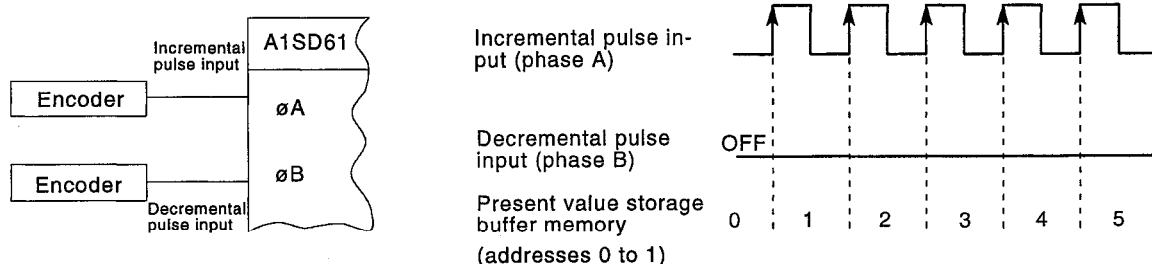

#### (2) Decremental count

When a decremental count is made, the operation timings of the incremental and decremental pulse inputs, and the present value of the storage buffer memory are shown below:

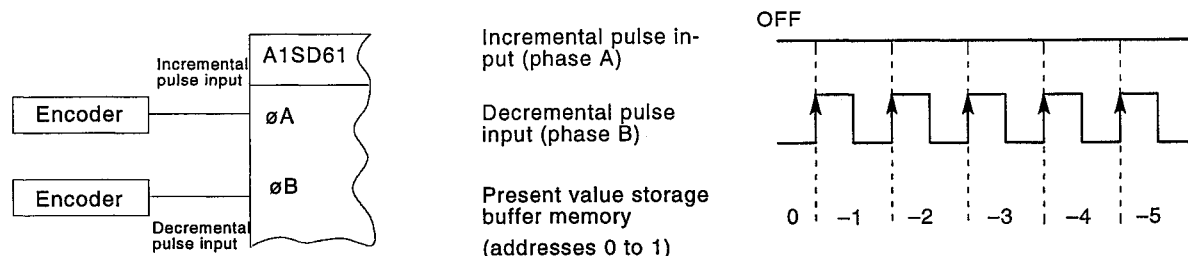

#### (3) Incremental/decremental count

When an incremental/decremental count is made, the operation timings of the incremental and decremental pulse inputs, and the present value of the storage buffer memory are shown below:

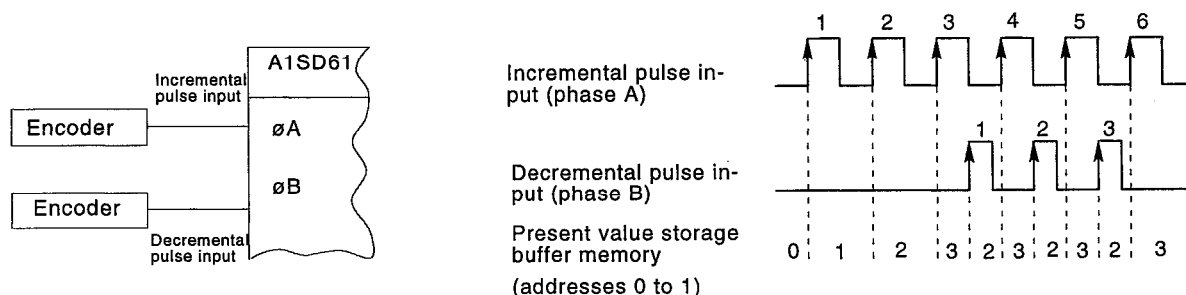



# 5. PULSE INPUT AND COUNTER PROCESSING METHOD

MELSEC-A

## 5.2 2-Phase Pulse Input

When the 2-phase pulse input is done, the counting mode can be selected from multiplication by one, two, and four.

- Multiplied by one: Incrementally and decrementally counts phase A pulses at the rise.
- Multiplied by two: Incrementally and decrementally counts phase A pulses both at the rise and at the fall.
- Multiplied by four: Incrementally and decrementally counts phase A/B pulses both at the rise and at the fall.

(1) The relationship between the phase A pulse input and the phase B pulse input is given below:

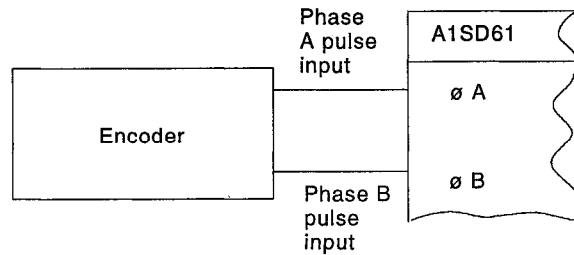

(2) Counter processing mode setting

To use the above-mentioned mode, set the A1SD61 pulse input mode setting buffer memory (address 4) to any number from 2 to 4 using the sequence program.

Counting Mode	Setting Value
Multiplied by one	2
Multiplied by two	3
Multiplied by four	4

[Sequence program]

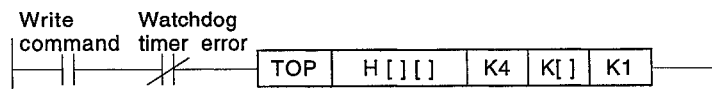

### REMARK

- 1) In [ [] ], set the first two digits of the 3-digit head I/O number in hexadecimal notation assigned to the A1SD61.
- 2) Set any number from 2 to 4 to [ ].

# 5. PULSE INPUT AND COUNTER PROCESSING METHOD

MELSEC-A

## 5.2.1 Counting using 2-phase pulse input multiplied by one

Count is made at rise of phase A pulse.

The phase difference between phase A and phase B pulses determines whether the count is made incrementally or decrementally.

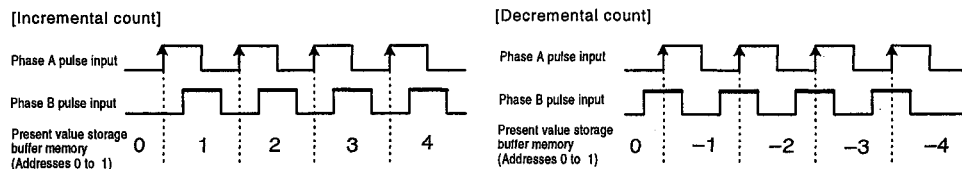

	Timings to Make an Incremental Count	
Phase A		Rise
Phase B		OFF

	Timings to Make a Decremental Count	
Phase A		Rise
Phase B		ON

### Precautions for counting using 2-phase pulse input multiplied by one

The A1SD61's counting using 2-phase pulse input multiplied by one is made at the rise of phase A.

Note the following points.

- (1) If pulse input is repeated in either of the following ranges, only increment or decrement is performed.

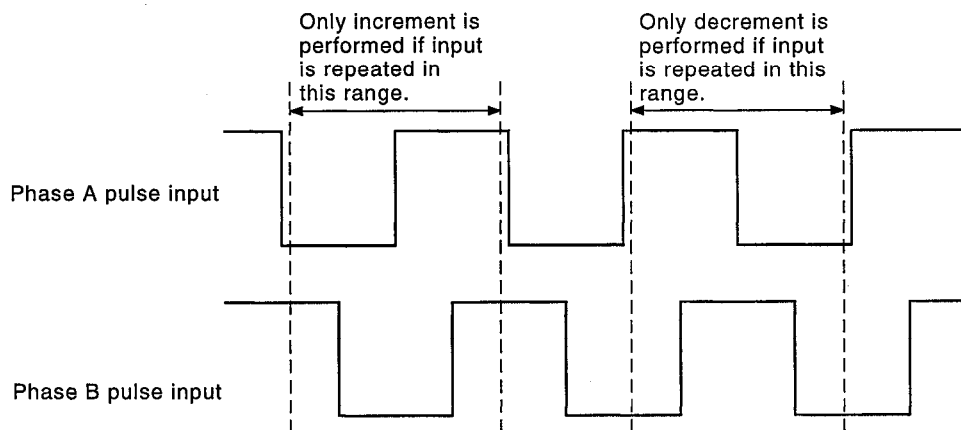

- (2) When the use of such increment and decrement as positioning control is required, it is recommended to use multiplication by four.

# 5. PULSE INPUT AND COUNTER PROCESSING METHOD

MELSEC-A

## 5.2.2 Counting using 2-phase pulse input multiplied by two

Count is made both at the rise and at the fall of the phase A pulse.

The phase difference between phase A and phase B pulses determines whether the count is made incrementally or decrementally.

[Incremental count]

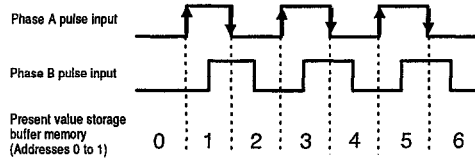

[Decremental count]

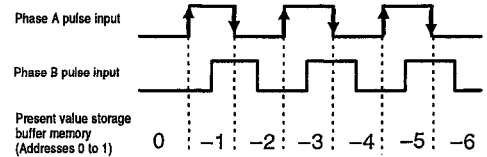

		Timings to Make an Incremental Count	
Phase A		Rise	Fall
Phase B		OFF	ON

		Timings to Make a Decremental Count	
Phase A		Rise	Fall
Phase B		ON	OFF

## 5.2.3 Counting using 2-phase pulse input multiplied by four

Count is made both at the rise and at the fall of the phase A/B pulse.

The phase difference between phase A and phase B pulses determines whether the count is made incrementally or decrementally.

[Incremental count]

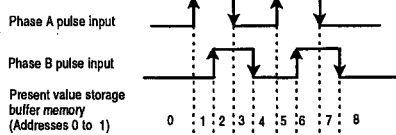

[Decremental count]

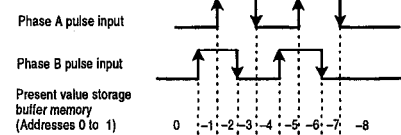

		Timings to Make an Incremental Count			
Phase A		Rise	Fall	ON	OFF
Phase B		OFF	ON	Rise	Fall

		Timings to Make a Decremental Count			
Phase A		Rise	Fall	OFF	ON
Phase B		ON	OFF	Rise	Fall

5.3 Reading the Present Value

The following describes the contents of the present value stored in the addresses from 0 to 1 of the A1SD61 buffer memory and how to read the present value.

- (1) The present value storage buffer memory stores the present value when any function is used.

When the latch counter, sampling counter or periodic pulse counter function is executed, the count value is stored into the counter function selection count value storage buffer memory, aside from the present value storage buffer memory. (Refer to Chapter 9.)

- (2) The present value of -2147483648 to 2147483647 is stored in signed 32-bit binary code to the buffer memory.

When the present value is negative, that data is stored as a complementary number of two to the present value of the storage buffer memory.

- (3) When an incremental count is made, if the value exceeds 2147483647, it will jump to -2147483648.

When a decremental count is made, if the value exceeds -2147483648, it will jump to 2147483647.

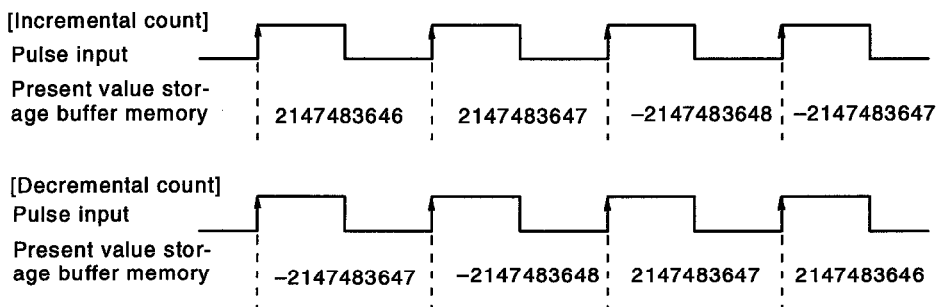

- (4) The sequence program used to read the present value from the buffer memory is shown below:

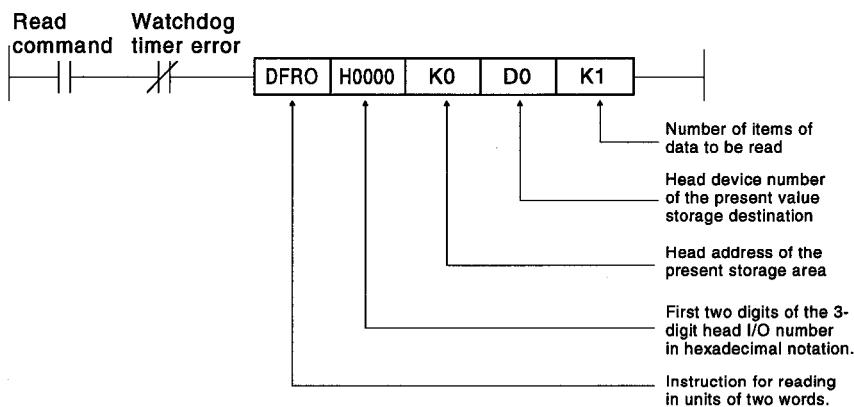

6. EXECUTING THE PRESET FUNCTION

This section explains the preset function.

6.1 Preset Function

The preset function is used for converting the counter's present value to a different value.

This changed value is called the preset value.

The preset function can be used when a pulse count is started from the set value.

The preset function consists of two modes: preset by the sequence program and preset from the external input (applying the voltage to the external terminal).

[Preset function application example]

By using the preset function, the production count can be continued from the previous day.

- (1) The production volume of the previous day is "preset" from the PLC CPU to the A1SD61.
- (2) Products are carried by a conveyor.
- (3) The production volume is counted by inputting the pulse from the photoelectric switch.
- (4) At the end of the daily production, the counter value in the buffer memory is stored to a word device (D, W, etc.) in the PLC CPU latch range.

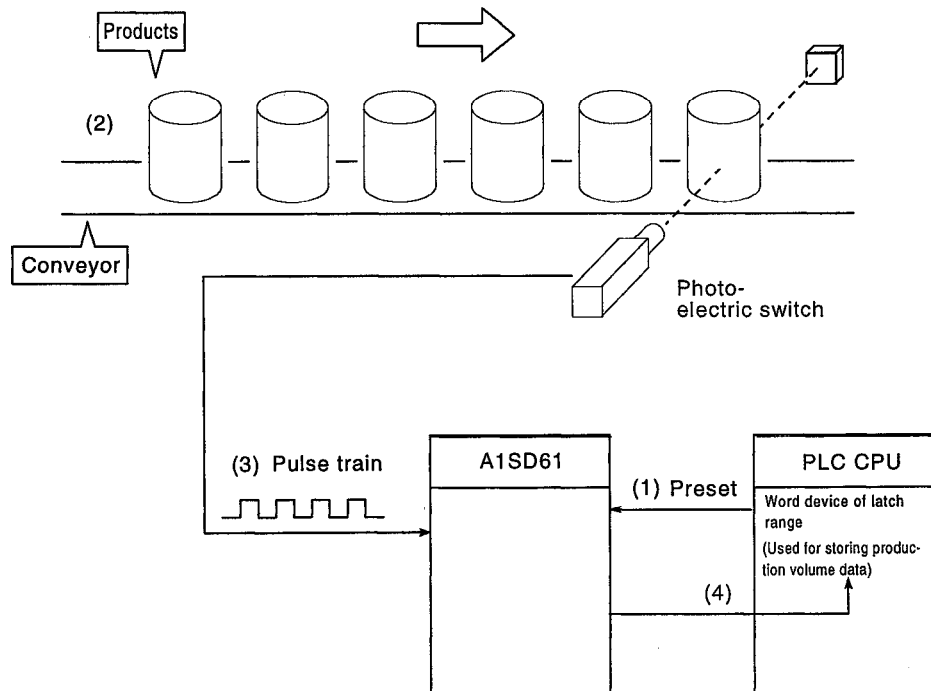

## 6.2 Preset Using the Sequence Program

The following describes the preset function executed by the sequence program.

### 6.2.1 Executing the preset function using the sequence program

Turn ON the preset command (Y12) in the sequence program to execute the preset.

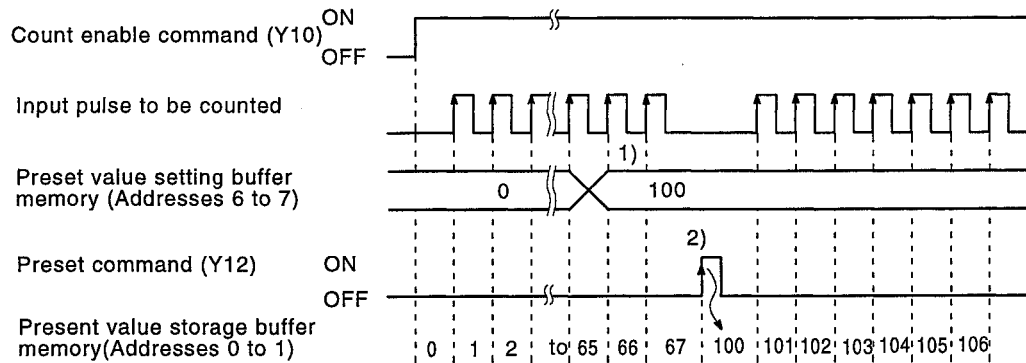

- 1) Writes a given value to the preset value setting buffer memory (addresses 6 to 7) in 32-bit binary code.
- 2) Turning ON the preset command (Y12) sets the preset value in the buffer memory to the present value buffer memory.

The preset function can be used whether the count enable command (Y10) is ON or OFF.

# 6. EXECUTING THE PRESET FUNCTION

## 6.2.2 Example program

The following program allows counting of 2-phase input pulses multiplied by one to execute preset using the sequence program.

[System configuration]

		X00 to X1F Y00 to Y1F		X20 to X3F	
A1S 62P	A1S CPU	A1S D61	A1S X41		

[Devices to be used]

(1) Execution commands

- (a) Pulse input mode setting command.....M9038
- (b) Count operation start command .....X20
- (c) Present value read command.....X21
- (d) Preset value write command.....X22
- (e) Preset command.....X23
- (f) Error reset command .....X24
- (g) Count operation stop command .....X25

(2) Relationship between data register (D0 to D5) and buffer memory

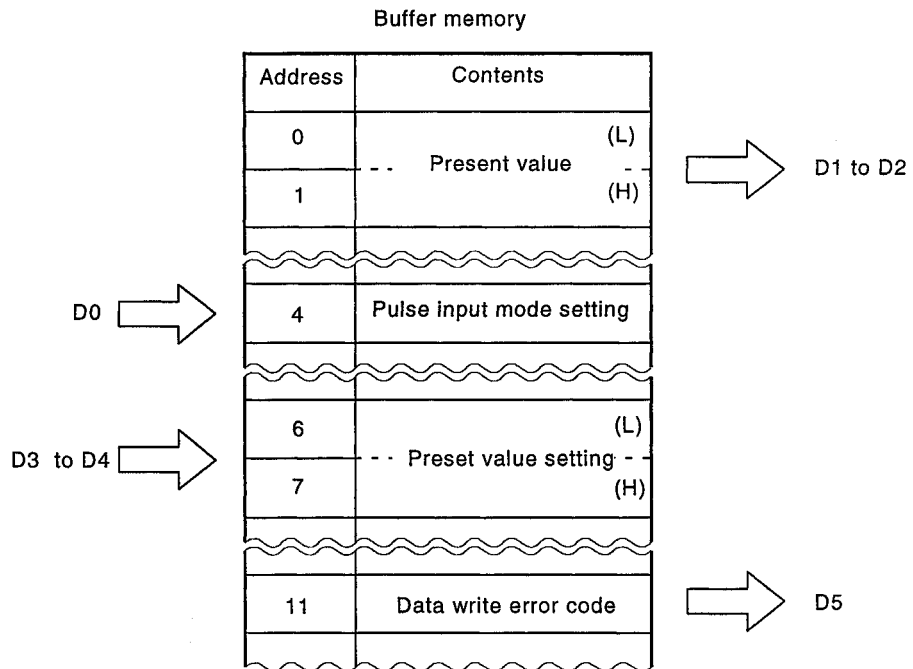

# 6. EXECUTING THE PRESET FUNCTION

MELSEC-A

[Example program]

**Pulse input mode setting**

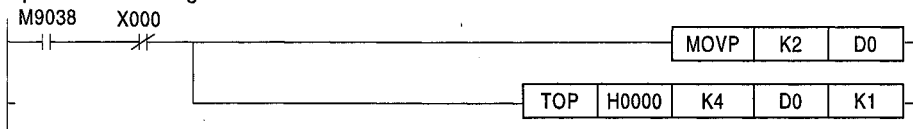

Set the pulse input mode of the 2-phase pulse input multiplied by one.

**Start the count operation.**

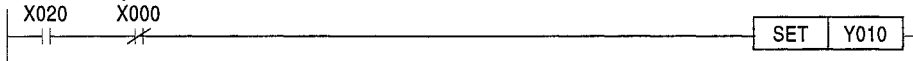

Start the pulse count with the count enable command (SET).

**Present value read**

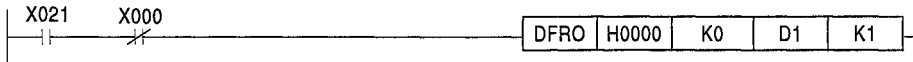

Read the present value and store it to devices D1 to D2.

**Preset command**

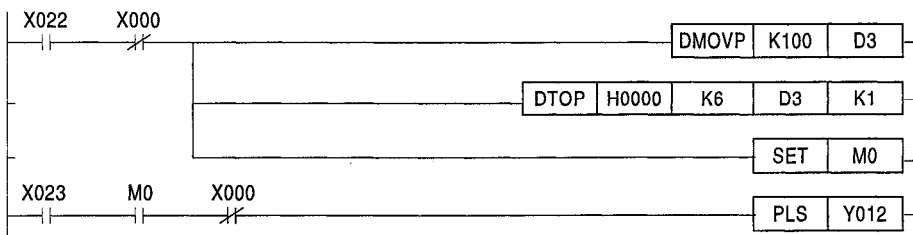

Store the preset value of 100 to address 6 of the buffer memory.

Execute the preset.

**Error detection/reset**

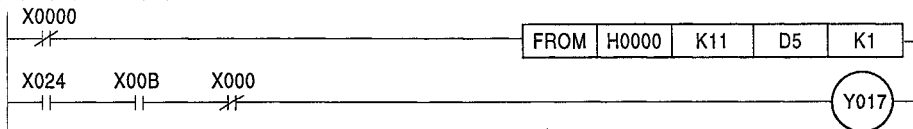

Read the error code and store it to device D5.

Reset the error.

**Count operation stop**

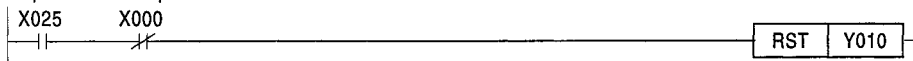

Stop the pulse count by the count enable command (RST).

CIRCUIT END



## 6. EXECUTING THE PRESET FUNCTION

MELSEC-A

<Precautions for creating preset program>

(1) When changing the preset value

When changing the preset value to execute the preset command (Y12), execute the command (Y12) one scan after setting the preset value as shown in the following program.

(As preset may not be executed depending on the timing)

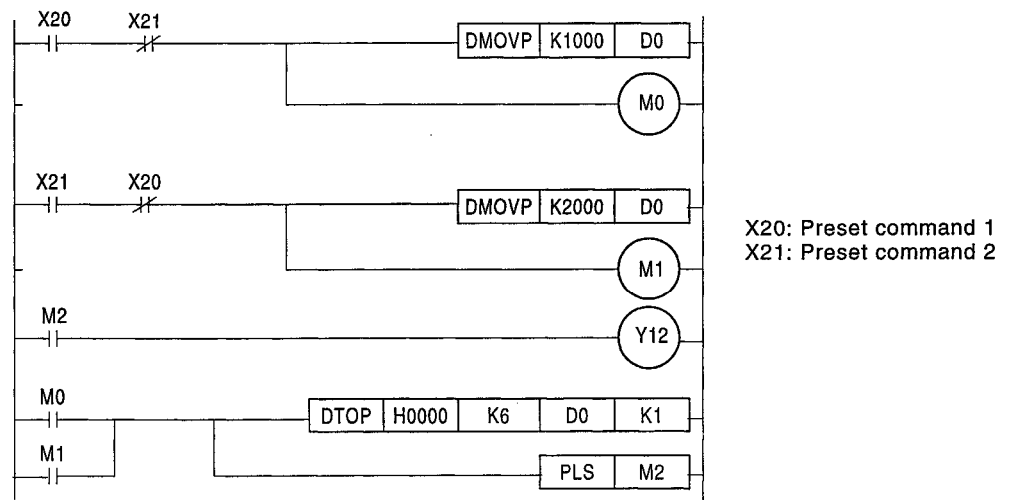

(2) When not changing the preset value

When the preset value once set is not changed, create the program as shown below.

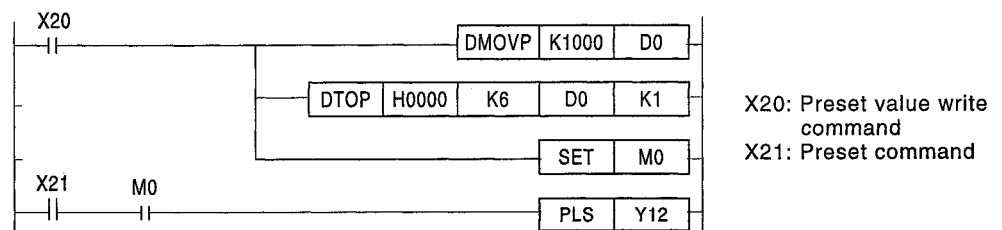

## 6.3 Preset by External Input

The following describes the preset by the external input.

### 6.3.1 When the preset is executed by external input

Execute the preset by applying the voltage to the external input PRESET terminal.

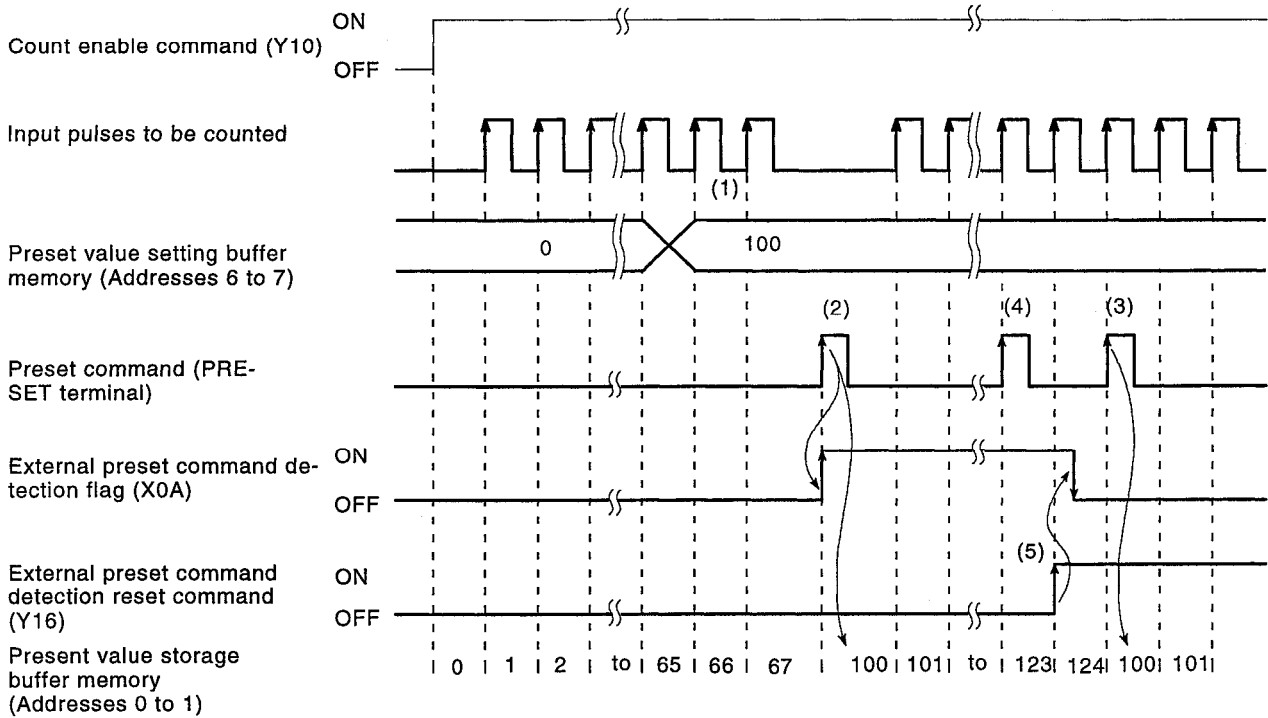

- 1) Writes a given value to the preset value of the setting buffer memory (addresses 6 to 7) in 32-bit binary code.
- 2) Executing the preset command (applying the voltage to the PRE-SET terminal) sets the preset value in the buffer memory to the present value buffer memory.
- 3) Even when the external preset command, detection reset command (Y16) is ON, the preset can be executed with the preset command (applying the voltage to the PRESET terminal).

The preset function can be used whether the count enable command (Y10) is ON or OFF.

#### POINT

(1) When the external preset detection flag (X0A) is ON (see (4) in the above-indicated diagram), even if the voltage is applied to the PRESET terminal, the preset function cannot be executed.

In this case, by turning ON the external preset command detection reset command (Y16) (see (5) in the above-indicated diagram), and turning OFF the external preset command detection flag (X0A), the preset function can be executed.

## 6. EXECUTING THE PRESET FUNCTION

MELSEC-A

### 6.3.2 Example program

The following program allows counting of 2-phase input pulses multiplied by one to execute preset using the external input.

[System configuration]

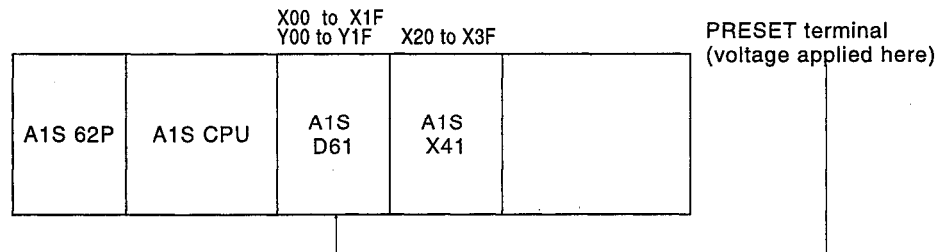

[Devices to be used]

#### (1) Execution commands

- (a) Pulse input mode setting command.....M9038
- (c) Count operation start command .....X20
- (d) Present value read command .....X21
- (e) Preset value write command.....X22
- (f) External preset command detection flag reset command ..... X0A
- (g) Error reset command .....X23
- (h) Count operation stop command .....X24

#### (2) Relationship between data register (D0 to D5) and buffer memory

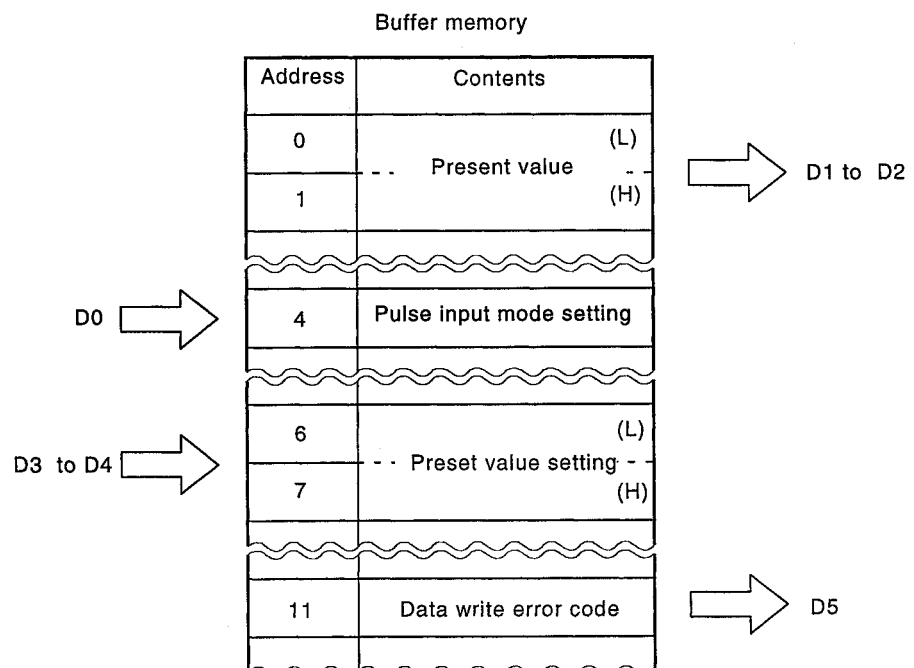

# 6. EXECUTING THE PRESET FUNCTION

MELSEC-A

[Example program]

Pulse input mode setting

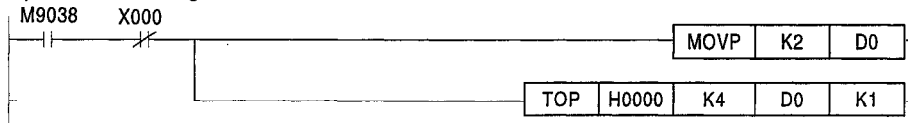

The following program counts 2-phase pulses multiplied by one and executes preset using the sequence program.

Start the count operation.

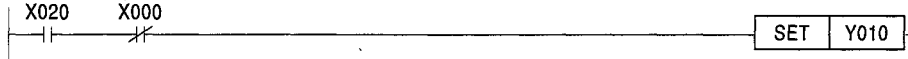

Start the pulse count with the count enable command (SET).

Present value read

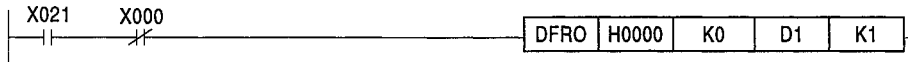

Read the present value and store it to devices D1 to D2.

Preset command

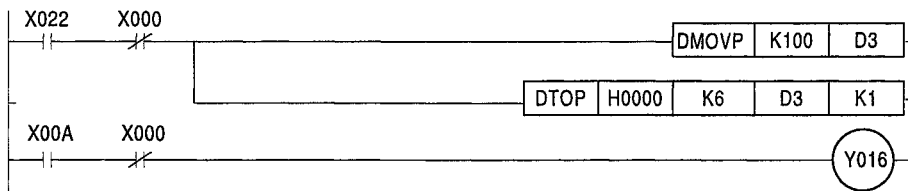

Store the preset value of 100 to address 6 of the buffer memory.

Reset the external preset command detection flag.

Error detection/reset

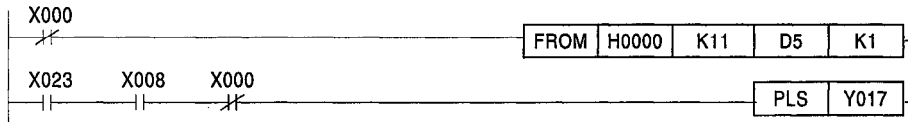

Read the error code and store it to device D5.

Reset the error.

Count operation stop

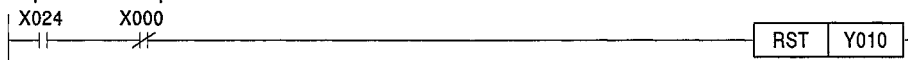

Stop the pulse count by the count enable command (RST).

CIRCUIT END

## 7. EXECUTING THE RING COUNTER FUNCTION

This section describes the ring counter function.

### 7.1 Ring Counter Function

The ring counter function allows repeated pulse counting between the preset value and ring counter value set with the ring counter command.

The ring counter can be used for a control such as fixed-pitch feed.

[Ring counter function application example]

Using a system to cut a sheet to a specified size, adjust its rollers by setting the ring counter value, and cut the sheet to the specified size.

- 1) Set the preset and ring counter values to execute the ring counter function.
- 2) Turn on the motor to operate the rollers.
- 3) Operate the rollers so that the sheet can be cut to the specified size.
- 4) Cut the sheet.
- 5) Repeat steps 2 to 4.

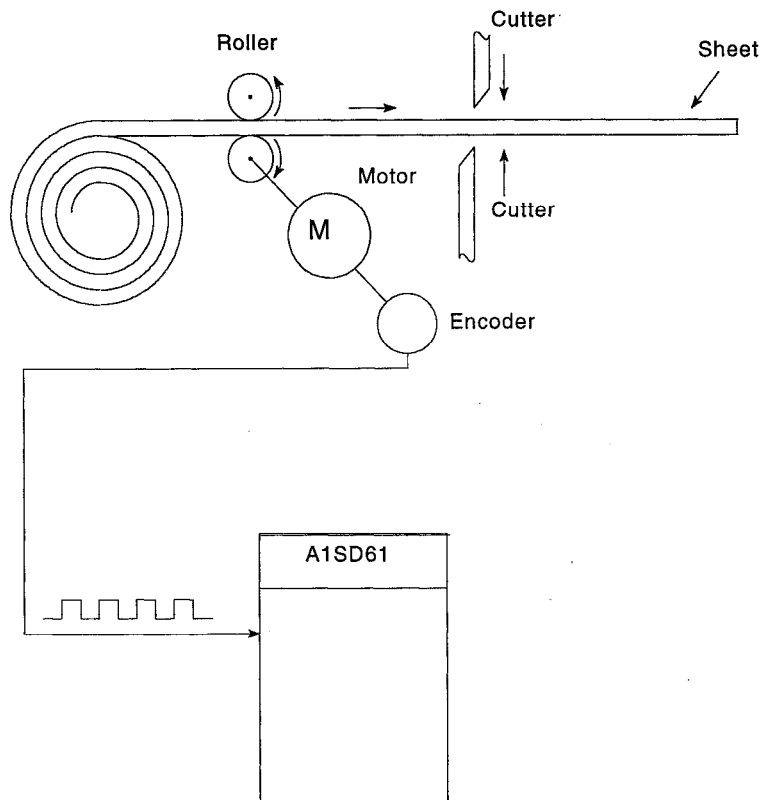

- (1) The ring counter function is executed when both the count enable command (Y10) and the ring counter commands (Y13) are ON.
- (2) Ring counter operation

When the present value of the counter is in the range between the preset value and ring counter value, pulses are counted within the range by the ring counter function.

When the ring counter function is executed, if the counter present value reaches the ring counter value, the present value will be automatically set to the preset value.

Also, if the present value of the counter reaches the preset value, the preset value will remain the same.

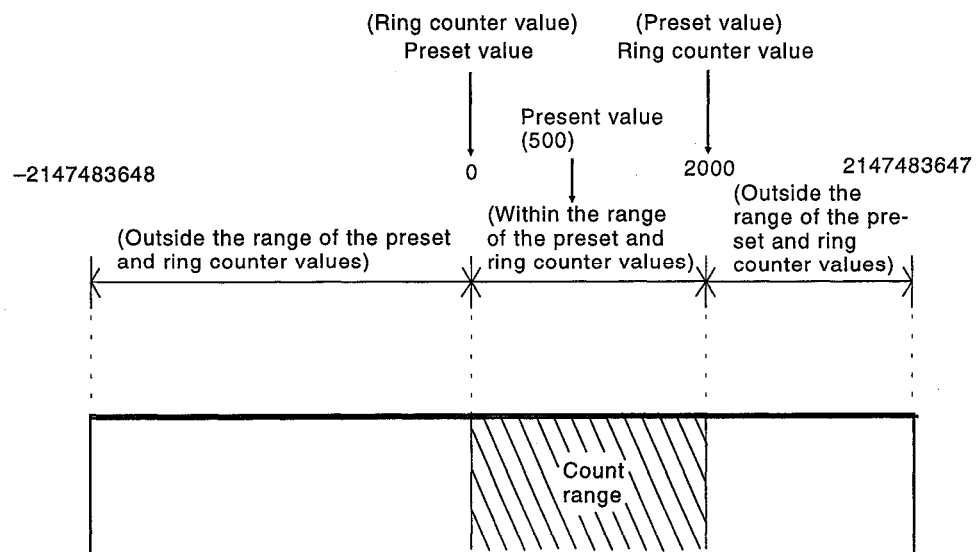

- (a) When the preset value of the storage buffer memory (addresses 6 to 7) is set to 0, the ring counter value of the storage buffer memory (addresses 8 to 9) to 2000, and the present value of the storage buffer memory (addresses 0 to 1) to 500 respectively, the ring counter is executed as shown below:

1) Increment count:

If the ring counter value reaches the ring counter set value (2000), the present value storage buffer memory (addresses 0 to 1) will be set to the preset value (0).

The ring counter value (2000) is stored to the present value storage buffer memory.

2) Decrement count:

If the ring counter value reaches the preset value (0), the preset value will remain.

When the next count is made, the preset value  $\rightarrow$  (ring counter value - 1) is stored to the present value of the storage buffer memory.

The ring counter value (2000) is not stored to the present value of the storage buffer memory.

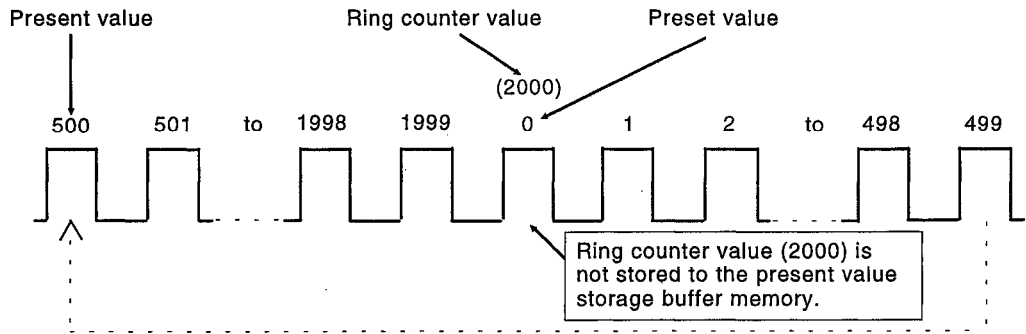

(b) When the preset value of the storage buffer memory (addresses 6 to 7) is set to 2000, the ring counter value of the storage buffer memory (addresses 8 to 9) to 0, and the present value of the storage buffer memory (addresses 0 to 1) to 500 respectively, the ring counter is executed as shown below:

1) Increment count:

If the ring counter value reaches the preset value (2000), the preset value will remain.

When the next count is made, the preset value  $\rightarrow$  (ring counter value + 1) is stored to the present value of the storage buffer memory.

The ring counter value (0) is not stored to the present value of the storage buffer memory.

2) Decrement count:

If the ring counter value reaches the preset value (0), the preset value (2000) is stored to the present value of the storage buffer memory.

The ring counter value (0) is not stored to the present value of the storage buffer memory.

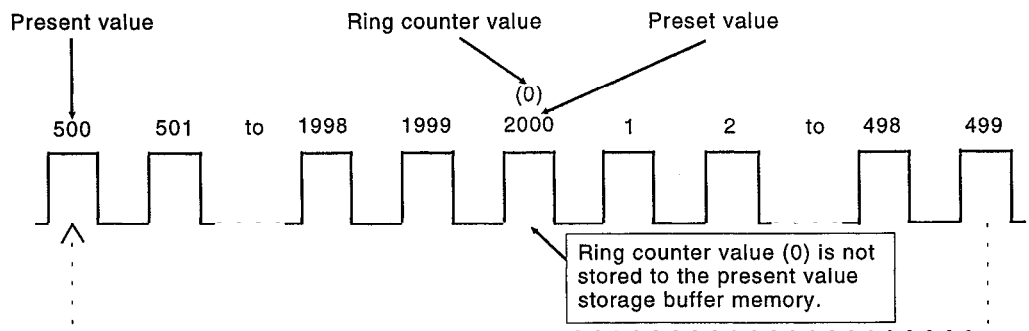

**REMARK**

1) If the ring counter starts when the present value is outside the range of the preset and ring counter values (except when the present value is equal to the preset and ring counter values), the count cannot be made within the range of the preset and ring counter values.

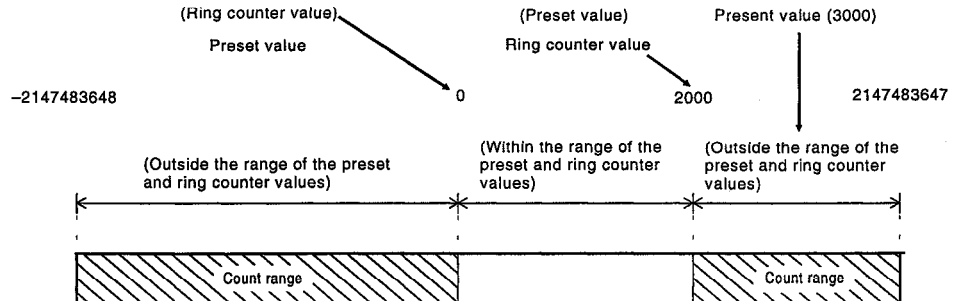

When the preset value storage buffer memory (addresses 6 to 7) is set to 0, the ring counter value storage buffer memory (addresses 8 to 9) to 2000, and the present value storage buffer memory (addresses 0 to 1) to 3000 respectively, the ring counter is executed as shown below:

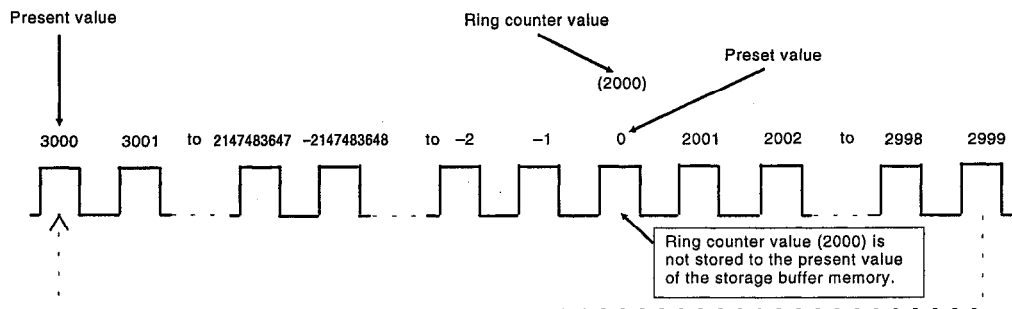

**POINT**

When the present value of the counter is outside the range of the preset and ring counter values, the present value of the counter can be changed to the preset value using the preset command (Y12).

**POINT**

(1) When the ring counter function is executed, do not write the preset value or ring counter value.

If the write is executed, an error will occur and the error code (14) will be stored as a data error of the storage buffer memory (address 11).

(2) When the ring counter function is executed, make sure that the difference between the preset and the ring counter values is larger than the number of input pulses per msec.

$$| \text{Preset value} - \text{Ring counter value} | \geq \text{Number of pulses/msec}$$

Example: When the pulse input speed is more than 50k pps:

When the pulse is input at a speed of 50k pps, make sure that the difference between the preset and the ring counter values is larger than 50 (pulses/msec).



7.2 Example Program

The following program allows the A1SD61 to count 2-phase input pulses multiplied by one and execute the ring counter function.

[System configuration]

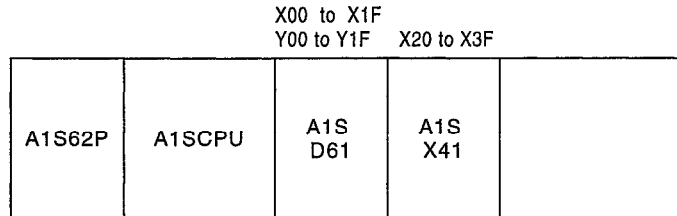

[Devices to be used]

(1) Execution commands

- (a) Pulse input mode setting command.....M9038
- (b) Count operation start command.....X20
- (c) Present value read command.....X21
- (d) Preset/ring count value write command.....X22
- (e) Ring counter command.....X23
- (f) Error reset command.....X24
- (g) Count operation stop command.....X25
- (h) Counter present value change command.....X26

(2) Relationship between the data register (D0 to D7) and the buffer memory

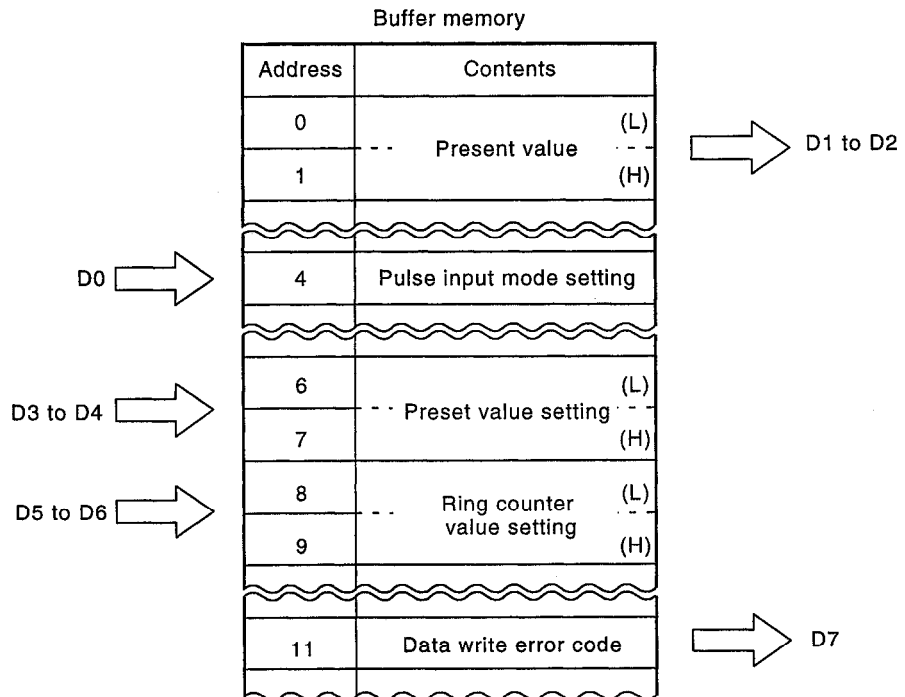

# 7. EXECUTING THE RING COUNTER FUNCTION

MELSEC-A

[Example program]

### Pulse input mode setting

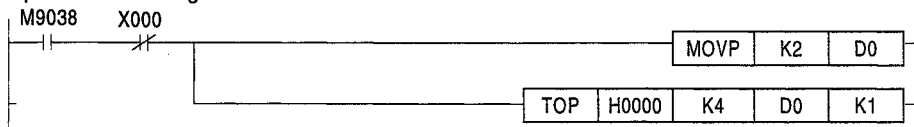

Set the pulse input mode of the 2-phase pulse input multiplied by one.

### Start the count operation.



Start the pulse count with the count enable command (SET).

### Present value read



Read the present value and store it to devices D1 to D2.

### Ring counter command

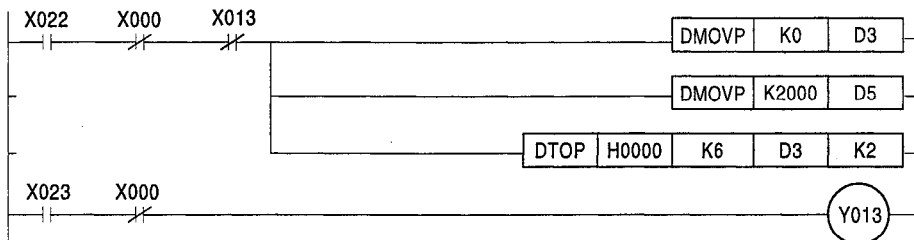

Store the preset and ring counter values to addresses 6 to 9 of the buffer memory.

Execute the ring counter.

### Error detection/reset

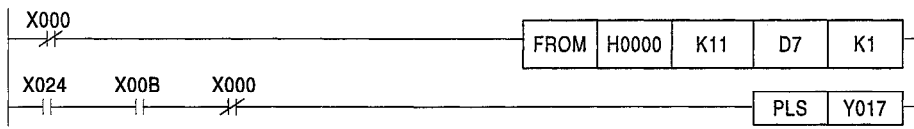

Read the error code and store it to device D7.

Reset the error.

### Count operation stop

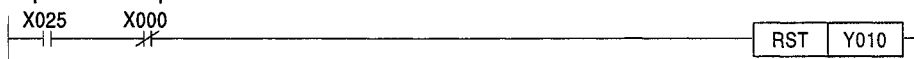

Stop the pulse count by the count enable command (RST).

### Counter present value change

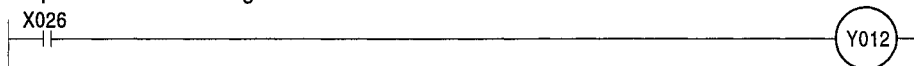

Change the present value of the counter to the preset value.

CIRCUIT END

## 8. EXECUTING THE LIMIT SWITCH OUTPUT FUNCTION

This section describes the limit switch output function.

### 8.1 Limit Switch Output Function

The limit switch output function is used in the following cases:

When the counter present value is consistent with a specified limit output status (ON/OFF address) of a certain channel, the ON/OFF signal is output.

When the limit switch output enable flag (X09) is not set, turning ON the limit switch output command (Y15) does not activate the limit switch output function.

Instead of the conventional limit switch, the limit switch output can be also applied to a series of the operations on the processing line.

#### [ Limit switch output function application example ]

By using a processing line system, products are made through the processing operations corresponding to each channel.

- 1) Carries material with the belt conveyor.
- 2) The location of material is known through the counter present value since the pulses are input to the A1SD61.
- 3) When the work reaches the corresponding preset position, it is processed according to the limit switch output (CH1 to CH4) from the A1SD61.

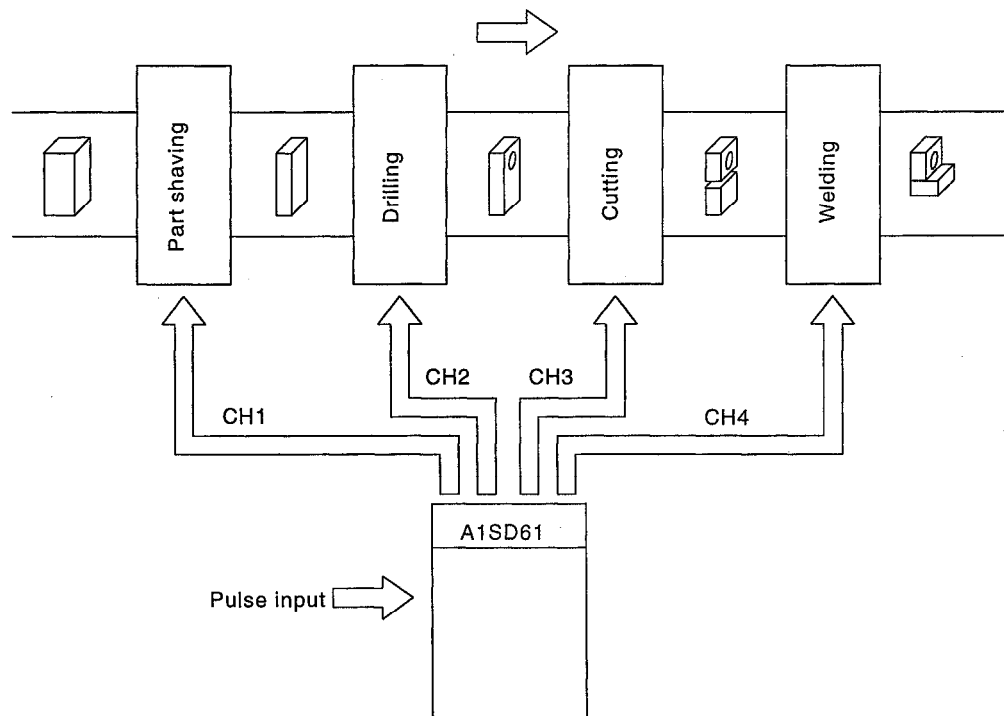

## 8. EXECUTING THE LIMIT SWITCH OUTPUT FUNCTION

MELSEC-A

- (1) In limit switch output, up to 8 channels can be used.

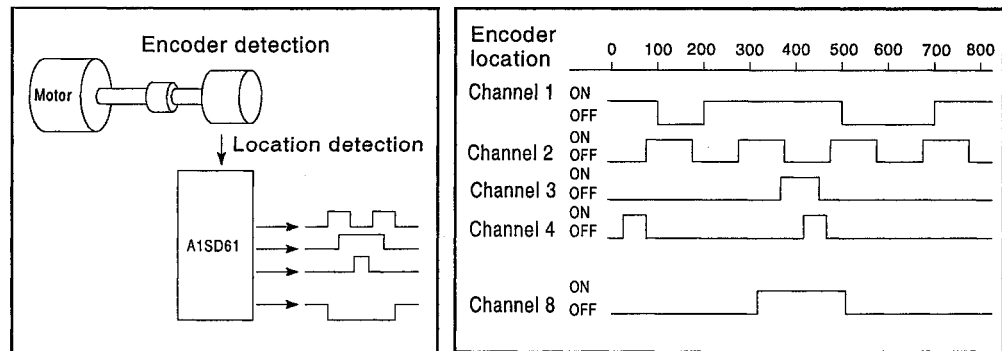

- (2) These are four dogs per channel.

In this manual, the dog refers to concave or convex parts as shown below:

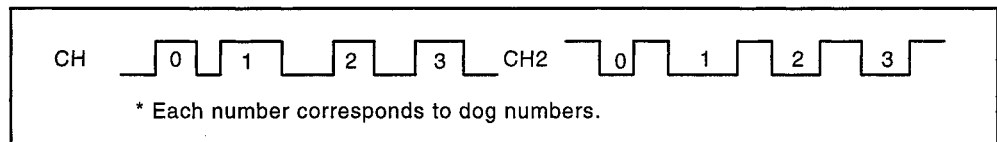

- (3) The speed of the pulse input will determine the minimum setting width at ON/OFF states.

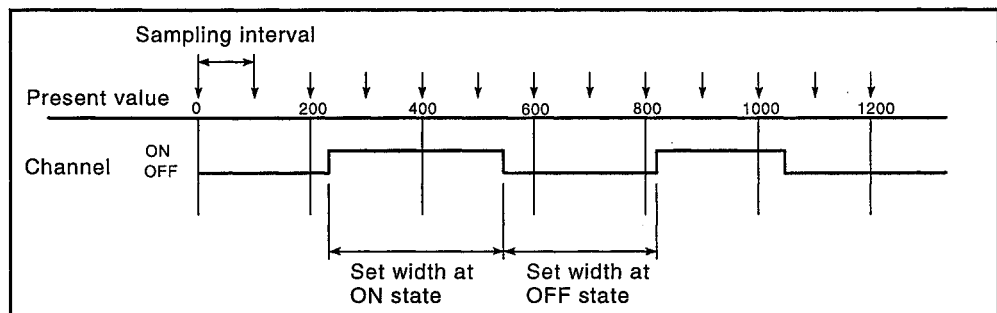

In the A1SD61, the position data is sampled at intervals of 1.0ms and compared them with the set ON/OFF data to output the limit switch signal.

Therefore, if the pulse input speed exceeds the allowable speed, the location cannot be detected in units of minimum length and the ON/OFF signal cannot be executed according to the specification.

In this case, enlarge the set width of the ON or OFF signal.

Find the allowable speed using the following formula:

- (a) Set width at ON state:

$$\frac{\text{Pulse input speed [pps]} \times (\text{Multiplication number})}{1000} \leq (\text{Count present value at OFF}) - (\text{Count present value at ON})$$

- (b) Set width to the OFF state:

$$\frac{\text{Pulse input speed [pps]} \times (\text{Multiplication number})}{1000} \leq (\text{Count present value at ON}) - (\text{Count present value at OFF})$$

## 8. EXECUTING THE LIMIT SWITCH OUTPUT FUNCTION

MELSEC-A

- (4) The timing of each signal when the limit switch output function is executed:

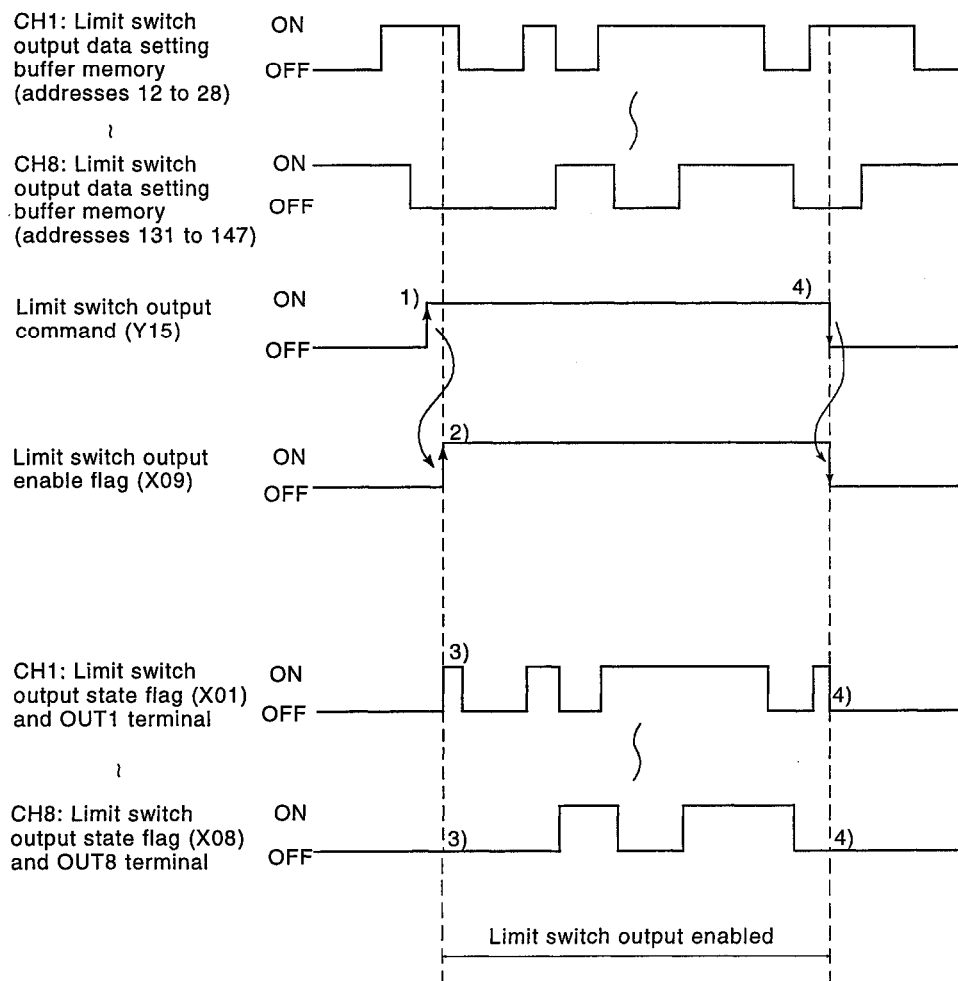

- 1) Turning ON the limit switch output command (Y15) verifies whether or not the set limit switch output data contains an error. When no error is detected, the limit switch output enable flag (X09) will be set.
- 2) Turning ON the limit switch output enable flag (X09) executes the limit switch output function.
- 3) The present value of the counter is compared with the set limit switch output data. The data is then output to the limit switch output state flags (X01 to X08) and the OUT terminals (OUTs 1 to 8).
- 4) Turning OFF the limit switch output command (Y15) turns OFF the limit switch output enable flag (X09) and turns OFF all the limit switch output status flags (X01 to X08) and OUT terminals (OUT1 to OUT8) of CH1 to CH8.

**POINT**

- (1) The limit switch output is executed whether the count enable command (Y10) is ON or OFF.
- (2) In the limit switch output, the preset, latch counter, and sampling counter execution commands are ignored until the limit switch output command (Y15) is turned ON to set the limit switch enable flag (X09).

However, the execution of the external input is valid.

[example] When the preset function is executed:

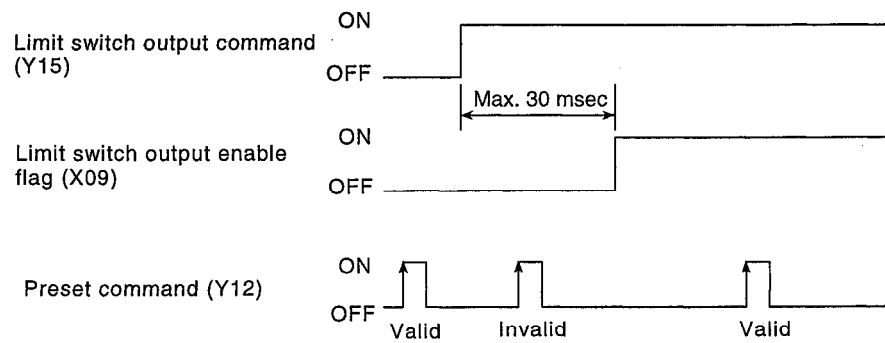

Create a program as show below:

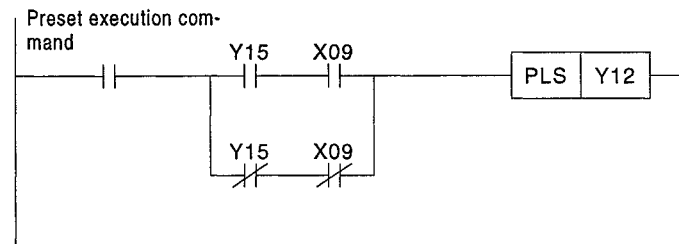

## 8. EXECUTING THE LIMIT SWITCH OUTPUT FUNCTION

MELSEC-A

- (5) Limit switch output data (CH1 to CH8) setting buffer memory (addresses 12 to 147)

This is an area in which ON/OFF data for each channel in the limit switch output function is stored.

- The data set consists of the number of multi-dogs and ON/OFF position data of each dog for each channel.
- The data set for the multi-dogs and ON/OFF position data is written in binary code.

If the number of the multi-dogs is set beyond the detection range or some dogs overlap, an error occurs.

The dog position write operation is divided into two modes: the dog position write in the ON range and the dog position write in the OFF range.

The A1SD61 automatically verifies if the dog data write is done in ON or OFF range by checking the contents of dog 0.

### 1) ON range (limit switch A contact operation) dog position write

In this case, the ON position data is written along with a value less than the OFF position data.

If the dogs are not written in ascending order, an error occurs.

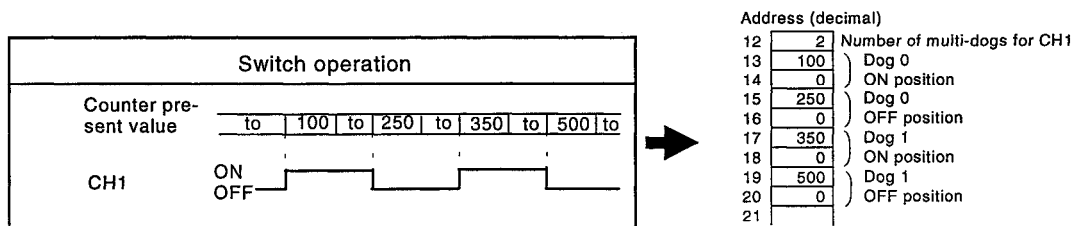

### 2) OFF range (limit switch B contact operation) dog position write

In this case, the ON position data is written along with a value larger than the OFF position data.

If the dogs are not written in ascending order, an error occurs.

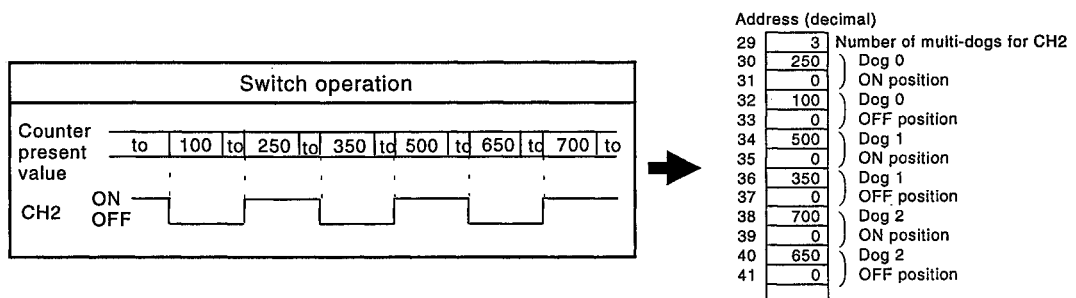

### REMARK

Both of the ON and OFF ranges cannot be used for a single channel.

[Example] When the dog 0 ON position is 100, the dog 0 OFF position is 200, the dog 1 ON position is 150, and the dog 1 OFF position is 400:

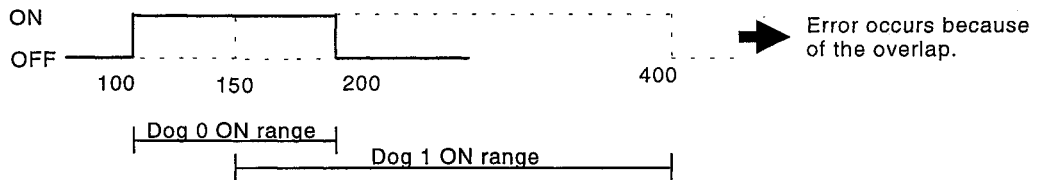

- 3) The number of multi-dogs can be set in the following range:  
0 to 4 (The lower 4 bits of the data set are valid.)

However, when this number is set to "0", the corresponding dog ON/OFF position data becomes invalid.

Also, when a value larger than "4" is set, an error occurs, disabling the limit switch output function.

- (c) The following occurs when an multi-dog setting error occurred:

- 1) Limit switch output enable flag (X09): OFF
- 2) Limit switch output states (X01 to X08 and OUTs 1 to 8): All channels are OFF

### POINT

- (1) When the limit switch output data is set or changed, make sure that the following conditions are satisfied:
- (a) The limit switch output enable command (Y15) is OFF.
  - (b) The limit switch output enable flag (X09) is OFF.

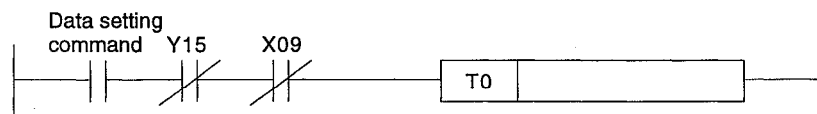

- (2) When the multi-dog data setting is erroneous (error code: 110 to 183, 201 to 208), turning ON the limit switch output command (Y15) does not turn ON the limit switch output enable flag (X09).

In this case, reset the error, and turn ON the limit switch output command (Y15) again.



## 8. EXECUTING THE LIMIT SWITCH OUTPUT FUNCTION

MELSEC-A

### 8.1.1 Example program

The following program allows the A1SD61 to count 2-phase input pulses multiplied by one and execute the limit switch output function.

#### [ System configuration ]

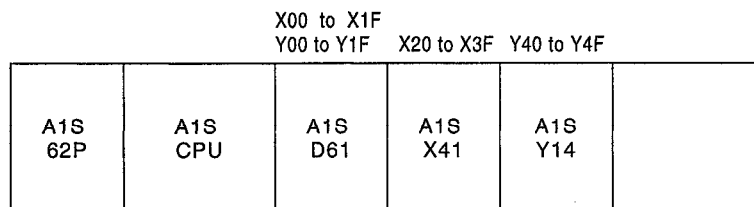

#### [ Operation status ]

ON/OFF status of the limit switch output is shown below:

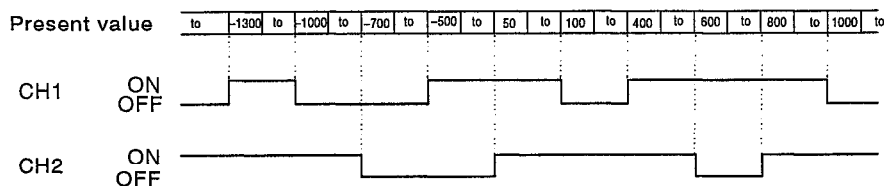

#### [ Devices to be used ]

##### (1) Execution commands

- (a) Pulse input mode setting command.....M9038
- (b) Fuse blown detection .....X0C
- (c) Count operation start command .....X20
- (d) Present value read command .....X21
- (e) Limit switch output data setting command.....X22
- (f) Limit switch output command .....X23
- (g) Error reset command .....X24
- (h) Count operation stop command .....X25

# 8. EXECUTING THE LIMIT SWITCH OUTPUT FUNCTION

MELSEC-A

(2) Relationship between the data register (D0 to D25) and buffer memory

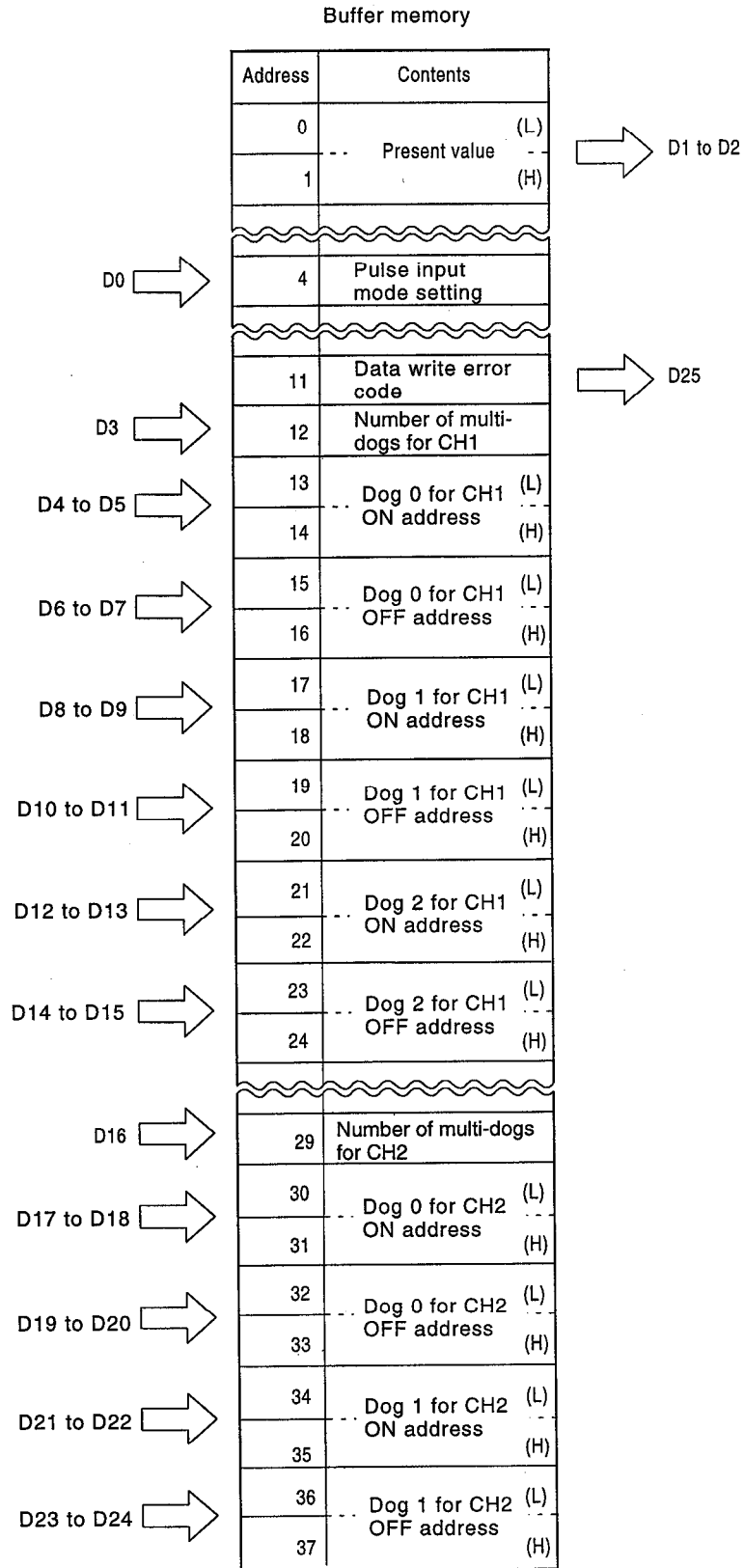

# 8. EXECUTING THE LIMIT SWITCH OUTPUT FUNCTION

MELSEC-A

[Example program]

Pulse input mode setting



Set the pulse input mode of the 2-phase pulse input multiplied by one.

Start the count operation.

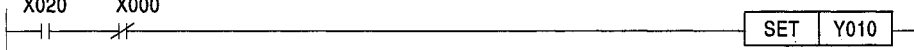

Start the pulse count by the count enable command (SET).

Present value read

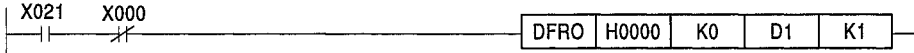

Read the present value and store it to devices D1 to D2.

Limit switch output command

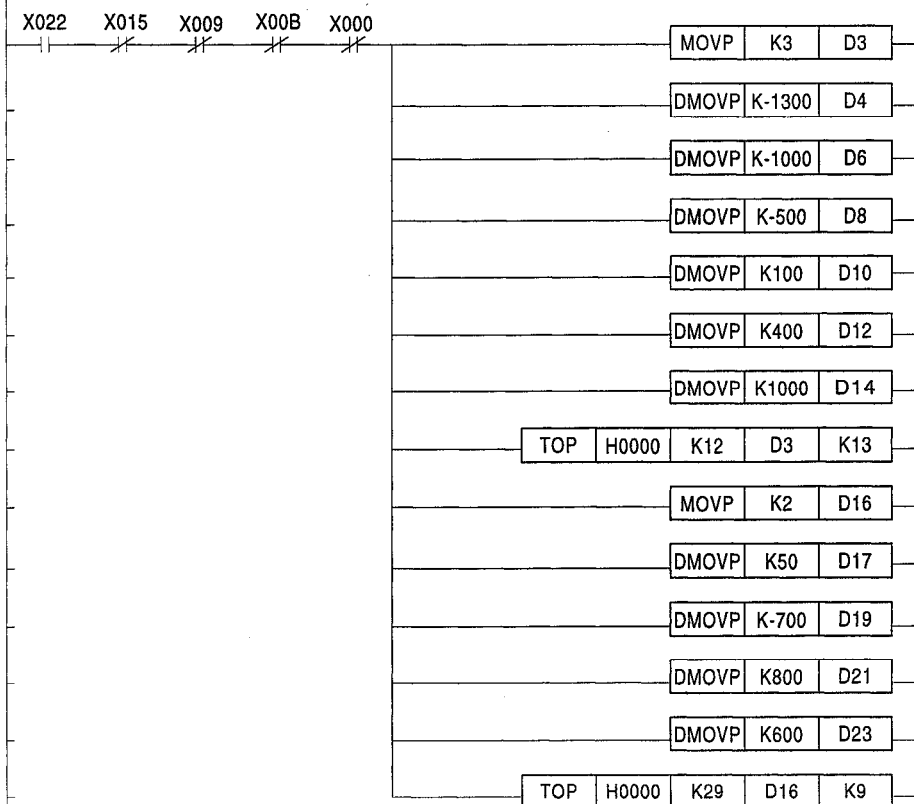

Number of multi-dogs for CH1  
Dog 0 ON address  
Dog 0 OFF address  
Dog 1 ON address  
Dog 1 OFF address  
Dog 2 ON address  
Dog 2 OFF address  
Store the contents in D3 to D15 in addresses 12 to 24 of the buffer memory.  
Number of multi-dogs for CH2  
Dog 0 ON address  
Dog 0 OFF address  
Dog 1 ON address  
Dog 1 OFF address  
Store the contents in D16 to D24 in addresses 29 to 37 of the buffer memory.



Execute the limit switch output.

# 8. EXECUTING THE LIMIT SWITCH OUTPUT FUNCTION

MELSEC-A

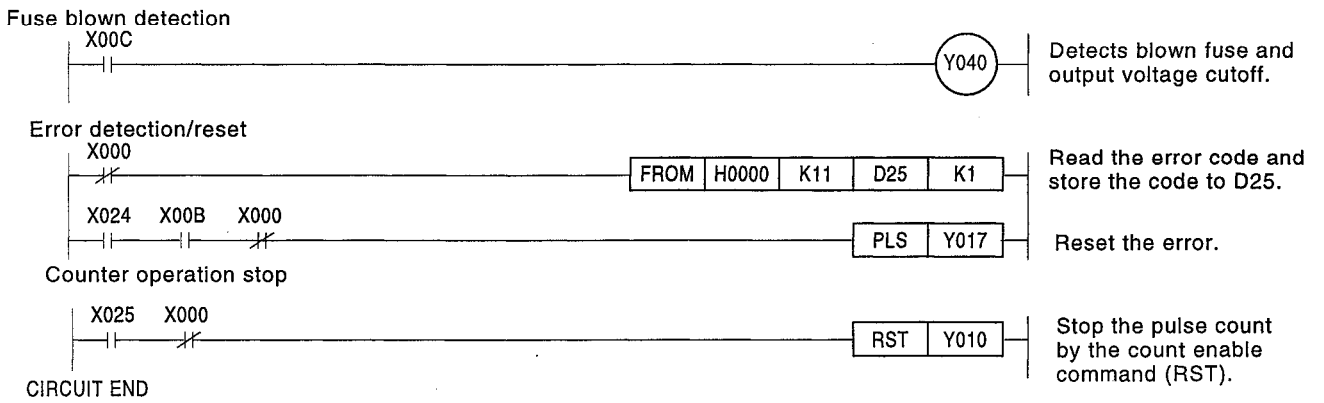

9. SELECTING AND EXECUTING THE COUNTER FUNCTION

9.1 Selecting a Counter Function

Select one of the four counter functions and execute it.

Execute the selected function by turning ON the counter function selection start command (Y14) or applying voltage to the external F.START terminal.

1) Latch counter function: See section 9.2.

Latches the present value of the counter when the signal is input.

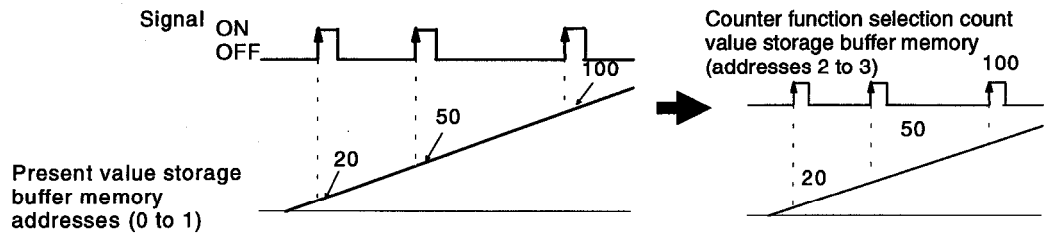

2) Sampling the counter function: See section 9.3.

The input pulses are counted at the preset time (T), after the signal inputs.

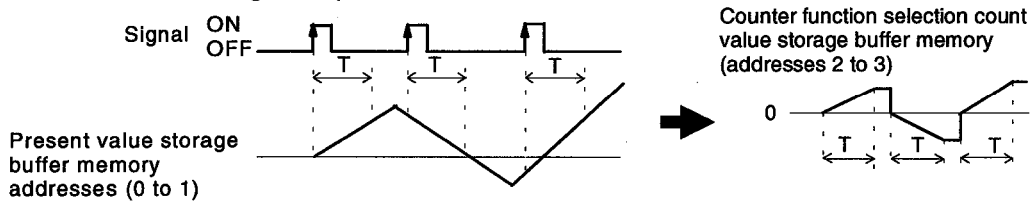

3) Periodic pulse counter function: See section 9.4.

Stores the number of input pulses at specified intervals while a signal input is done.

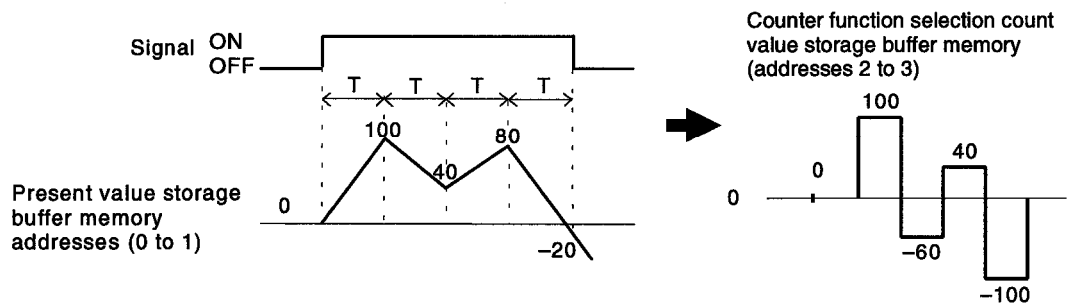

4) Count disable function: See section 9.5.

Inputs the signals when the count enable command is ON, stopping the pulse count.

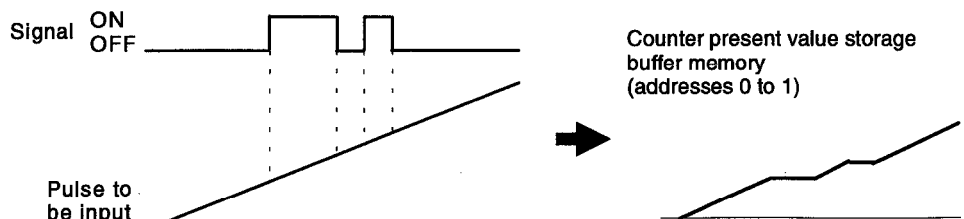

## 9. SELECTING AND EXECUTING THE COUNTER FUNCTION MELSEC-A

- (1) Select a counter function by writing a value to the counter function selection setting buffer memory (address 5) as shown in the following table:

However, when the counter function is changed, make sure that the counter function selection start command (Y14, F.START terminal) is OFF.

Counter Function Selection	Setting Value
None	0
Latch counter function	1
Sampling counter function	2
Periodic pulse counter function	3
Count disable function	4

- (2) The counter function can be selected by using either the counter function selection start command (Y14) or the F.START terminal (external input).

When both of the signals are input during a certain period, priority is given to the first signal input.

- (3) Set the time of the sampling counter function or periodic pulse counter function within the range from 1 to 65535.

The time can be set in 10ms increments and the accuracy is 0.7ms.

Example) When 420 is set to the sampling/periodic time setting buffer memory

$$420 \times 10 = 4200 \text{ [ms]}$$

# 9. SELECTING AND EXECUTING THE COUNTER FUNCTION MELSEC-A

## 9.1.1 Reading the counter value when executing the counter function selection

Read the counter value when the counter function is selected.

The following explains the counter function selection count value contents stored in the A1SD61 counter function selection count value storage buffer memory (addresses 2 to 3) and how to read the counter value:

- (1) In the counter function selection count value storage buffer memory, the value of the latch counter, sampling counter, or periodic pulse counter is stored.
- (2) The counter function selection count value (2147483648 to –2147483647) is stored in a signed 32-bit binary code.

When the counter function selection count value is negative, this value is stored as a complementary number of two.

- (3) When an incremental count is made, if the counter function selection count value exceeds 2147483647, it will jump to –2147483648.

When a decremental count is made, if the counter function selection count value exceeds –2147483648, it will jump to 2147483647.

- (4) The sequence program to read the counter function selection count value is shown below.

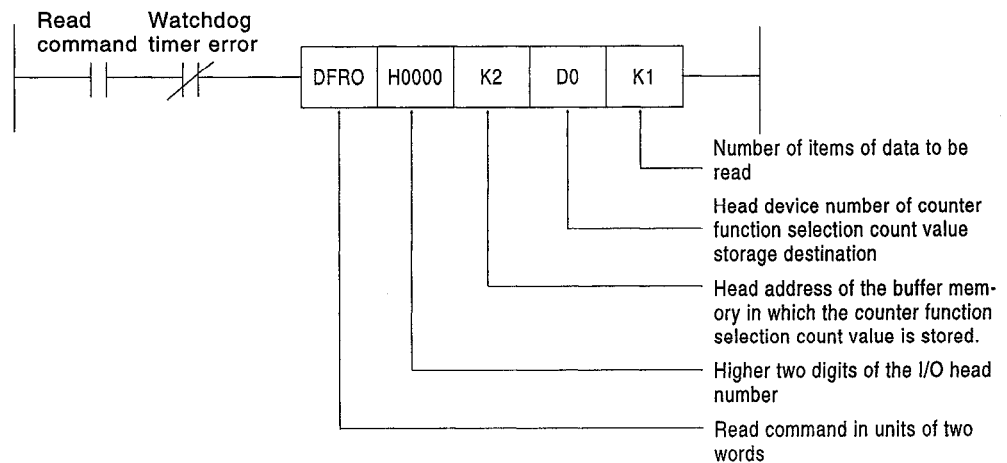

## 9. SELECTING AND EXECUTING THE COUNTER FUNCTION

MELSEC-A

### 9.1.2 Count errors

When the counter function selection is executed by the external input (applying the voltage to the F.START terminal) or by the sequence program (turning ON the counter function selection start command), there is an error in counting.

- (1) The error range when the counter function is executed by the external input is shown below:

**[Max. count error]**

$$\left(\frac{1 \text{ [ms]}}{1000}\right) [\text{s}] \times \text{pulse input speed [PPS]} \times \text{multiplication number [count]}$$

**[Min. count error]**

$$\left(\frac{0.1 \text{ [ms]}}{1000}\right) [\text{s}] \times \text{pulse input speed [PPS]} \times \text{multiplication number [count]}$$

- (2) When the counter function is executed by the sequence program, there is an additional error for one scan of the PC CPU besides the error as shown in (1).

**POINT**

Mitsubishi recommends that the counter function selection should be executed by the external input.



# 9. SELECTING AND EXECUTING THE COUNTER FUNCTION

MELSEC-A

## 9.2 Latch Counter Function

Latch the present value of the counter when a signal input is done.

The relationships between the counter present value and the counter function selection start command and between the present value and the counter function selection count value buffer memory are shown below:

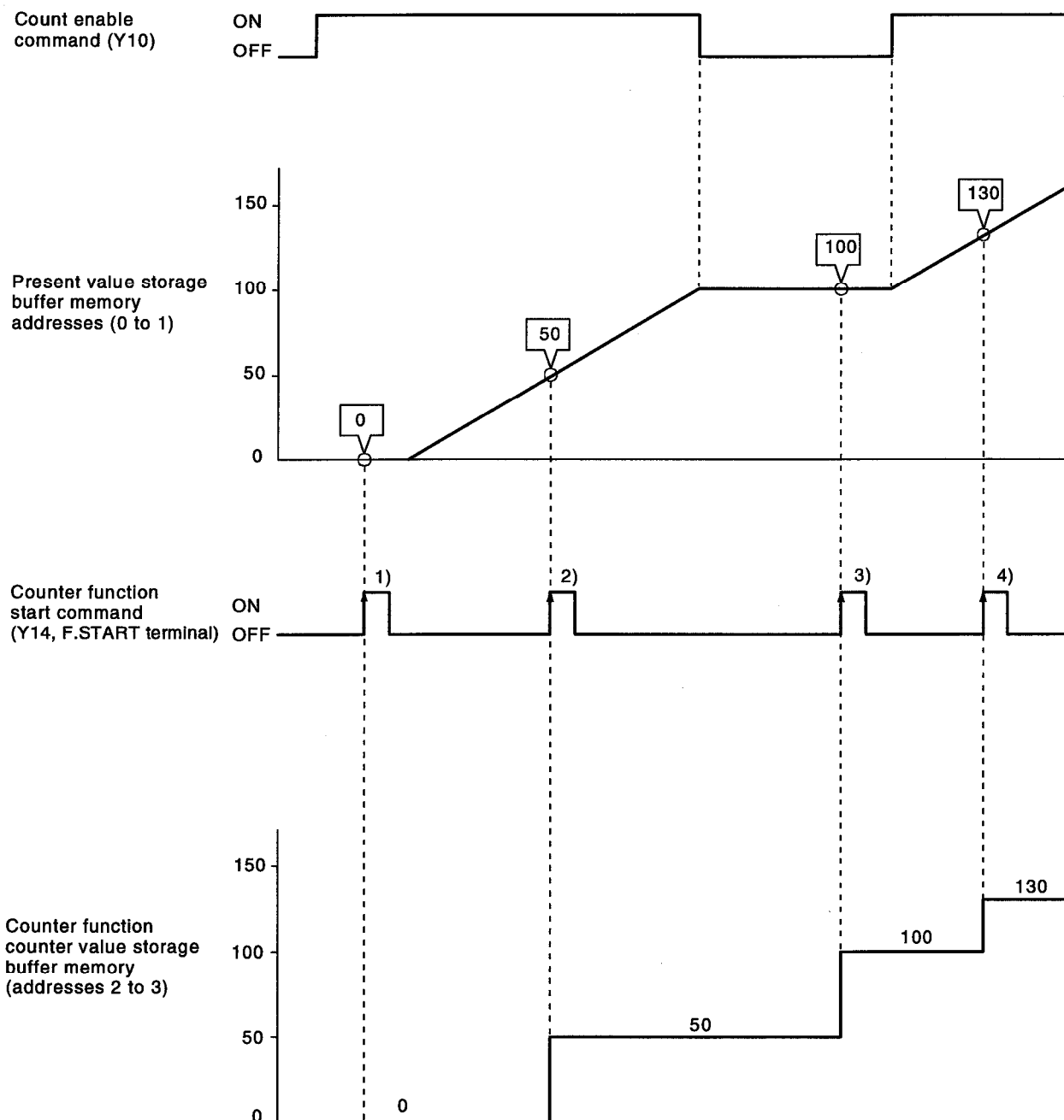

At the rise of the counter function selection start command (Y14, F.START terminal)(corresponding to 1) to 4) in the above diagram), the counter present value is stored to the counter function selection count value buffer memory (addresses 2 to 3).

The latch counter function works whether the count enable command (Y10) is ON or OFF.

# 9. SELECTING AND EXECUTING THE COUNTER FUNCTION MELSEC-A

## 9.2.1 Example program

The following program allows the A1SD61 to count 2-phase input pulses multiplied by one and execute the latch counter.

**[System configuration]**

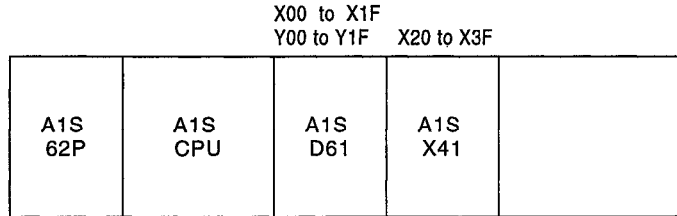

**[Devices to be used]**

(1) Execution commands

- (a) Pulse input mode setting command.....M9038
- (b) Count operation start command .....X20
- (c) Present value read command .....X21
- (d) Counter function selection count value read command.....X22
- (e) Counter function selection setting command .....X23
- (f) Latch counter command .....X24
- (g) Error reset command .....X25
- (h) Count operation stop command .....X26

(2) Relationship between the data register (D0 to D6) and the buffer memory

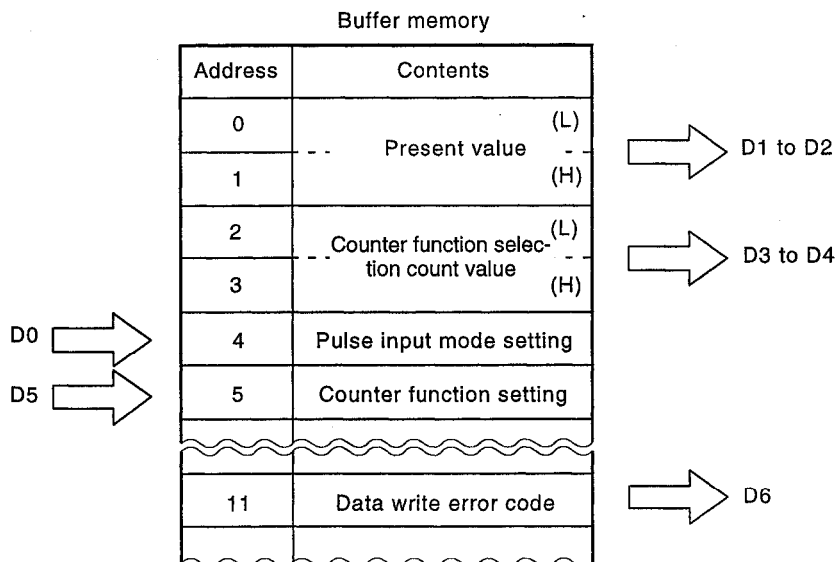

# 9. SELECTING AND EXECUTING THE COUNTER FUNCTION

MELSEC-A

[Example program]

## Pulse input mode setting

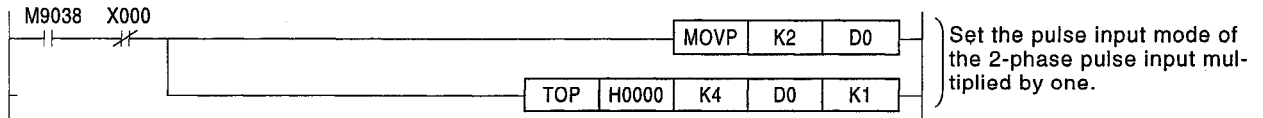

Set the pulse input mode of the 2-phase pulse input multiplied by one.

## Count operation start.

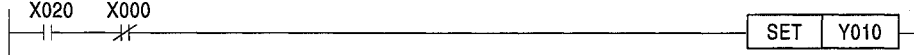

Start the pulse count with the count enable command (SET).

## Present value read

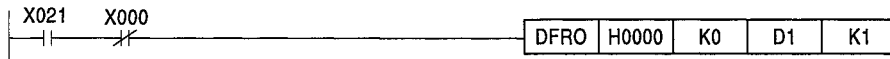

Read the present value and store it to devices D1 to D2.

## Latch counter command

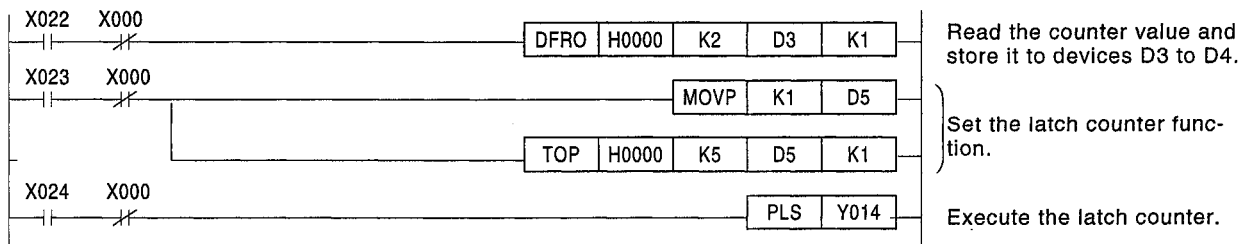

Read the counter value and store it to devices D3 to D4.

Set the latch counter function.

Execute the latch counter.

## Error detection/reset

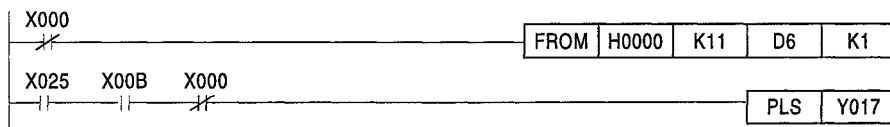

Read the error code and store it to device D6.

Reset the error.

## Count operation stop

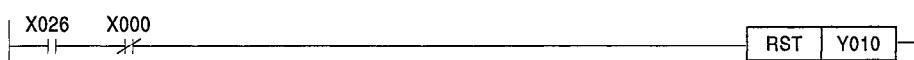

Stop the pulse count with the count enable command (RST).

CIRCUIT END

## 9. SELECTING AND EXECUTING THE COUNTER FUNCTION

MELSEC-A

### 9.3 Sampling Counter Function

Count the pulses when a sampling time is specified.

The sampling time can be set in 10ms increments and the accuracy is 0.7ms.

The relationship between each signal and the buffer memory is shown below:

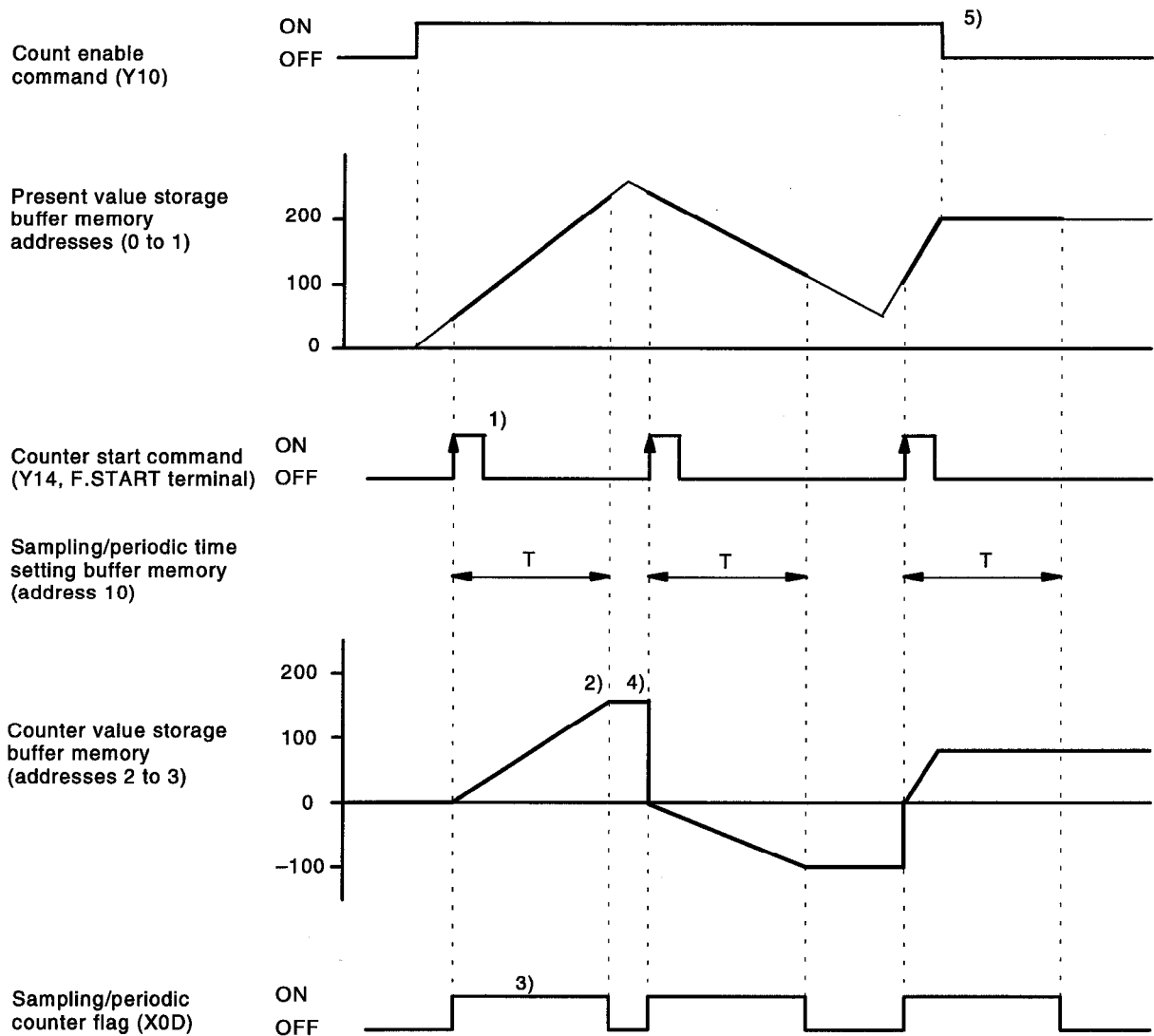

- 1) Starts counting input pulses from 0 at the rise of the counter function selection start command (Y14, F.START terminal).
- 2) Stops counting after the specified sampling time.
- 3) Keeps the sampling/periodic counter flag (X0D) ON during execution of the sampling counter function.
- 4) Retains the counter function selection count value in the buffer memory after completing the sampling counter function.
- 5) The sampling counter function works whether the count enable command (Y10) is ON or OFF.

# 9. SELECTING AND EXECUTING THE COUNTER FUNCTION

MELSEC-A

## 9.3.1 Example program

The following program allows the A1SD61 to count 2-phase input pulses multiplied by one and execute the sampling counter.

### [System configuration]

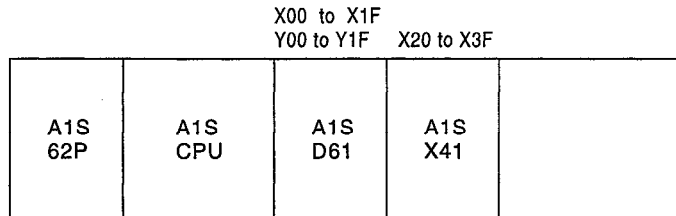

### [Devices to be used]

#### (1) Execution commands

- (a) Pulse input mode setting command.....M9038
- (b) Count operation start command.....X20
- (c) Present value read command.....X21
- (d) Counter function selection count value read command.....X22
- (e) Counter function selection setting command.....X23
- (f) Sampling time setting command.....X24
- (g) Sampling counter command:.....X25
- (h) Error reset command:.....X26
- (i) Count operation stop command:.....X27

#### (2) Relationship between the data register (D0 to D7) and the buffer memory

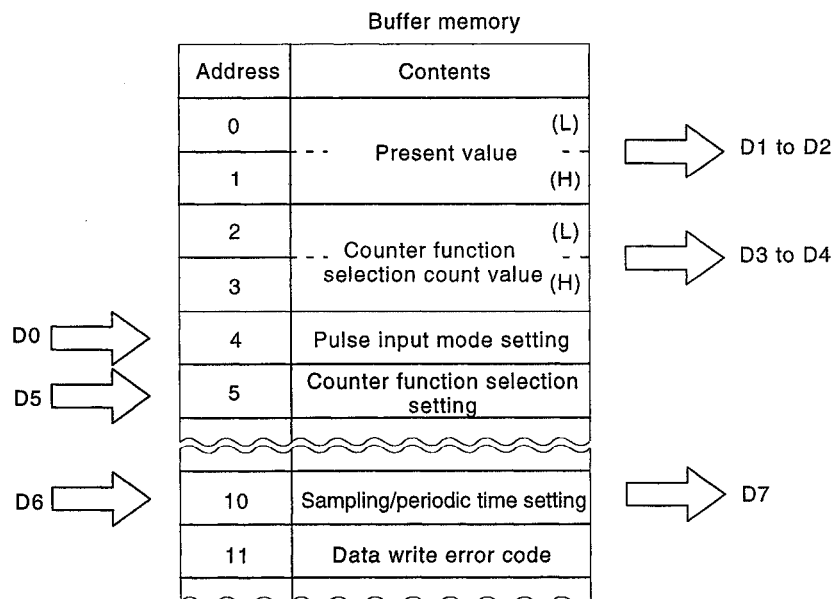

# 9. SELECTING AND EXECUTING THE COUNTER FUNCTION

MELSEC-A

[Example program]

## Pulse input mode setting

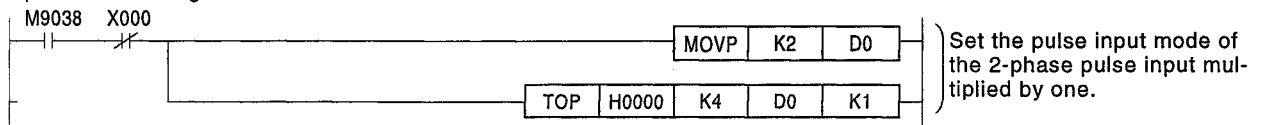

## Count operation start.

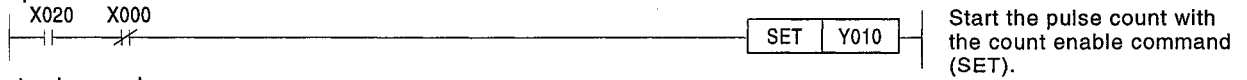

## Present value read

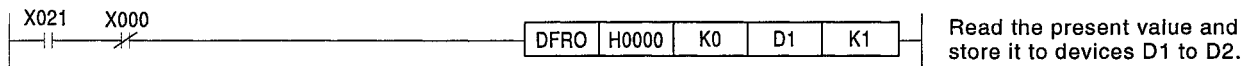

## Sampling counter command

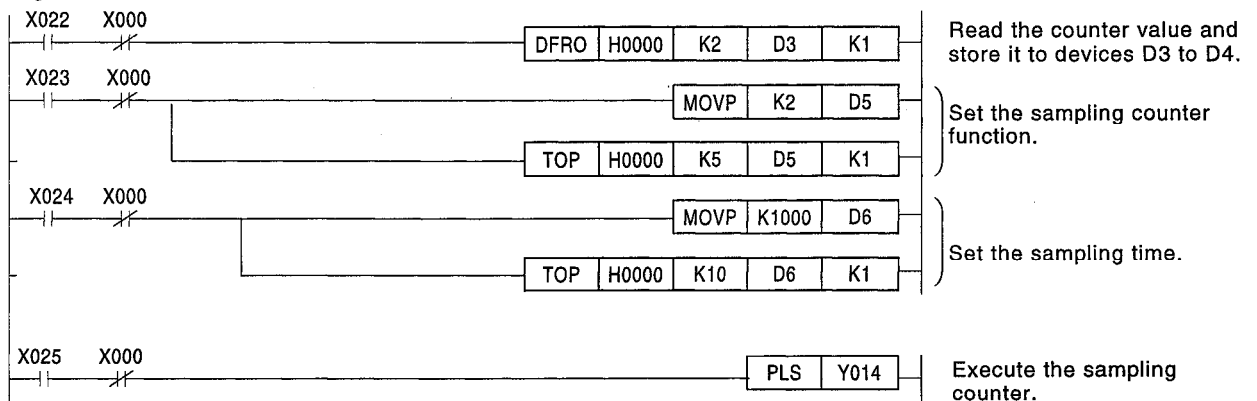

## Error detection/reset

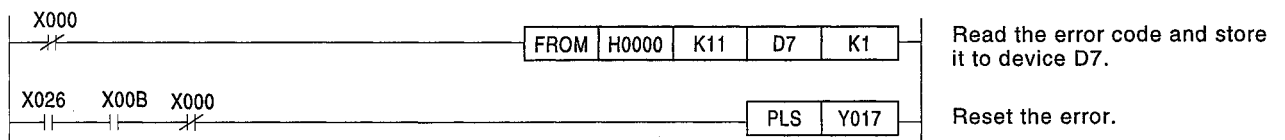

## Count operation stop



CIRCUIT END

# 9. SELECTING AND EXECUTING THE COUNTER FUNCTION

MELSEC-A

## 9.4 Periodic Pulse Counter Function

The periodic pulse counter function counts the number of pulses input at the preset intervals and stores them into the counter function selection count value storage buffer memory.

Find the value stored in the counter function selection count value storage buffer memory using the following formula:

$$\text{Stored value} = (\text{Counter present value after the periodic time}) - (\text{Counter present value at the start})$$

The periodic time can be set in 10ms increments and the accuracy is 0.7ms. The relationship between the each signal and the buffer memory is shown below:

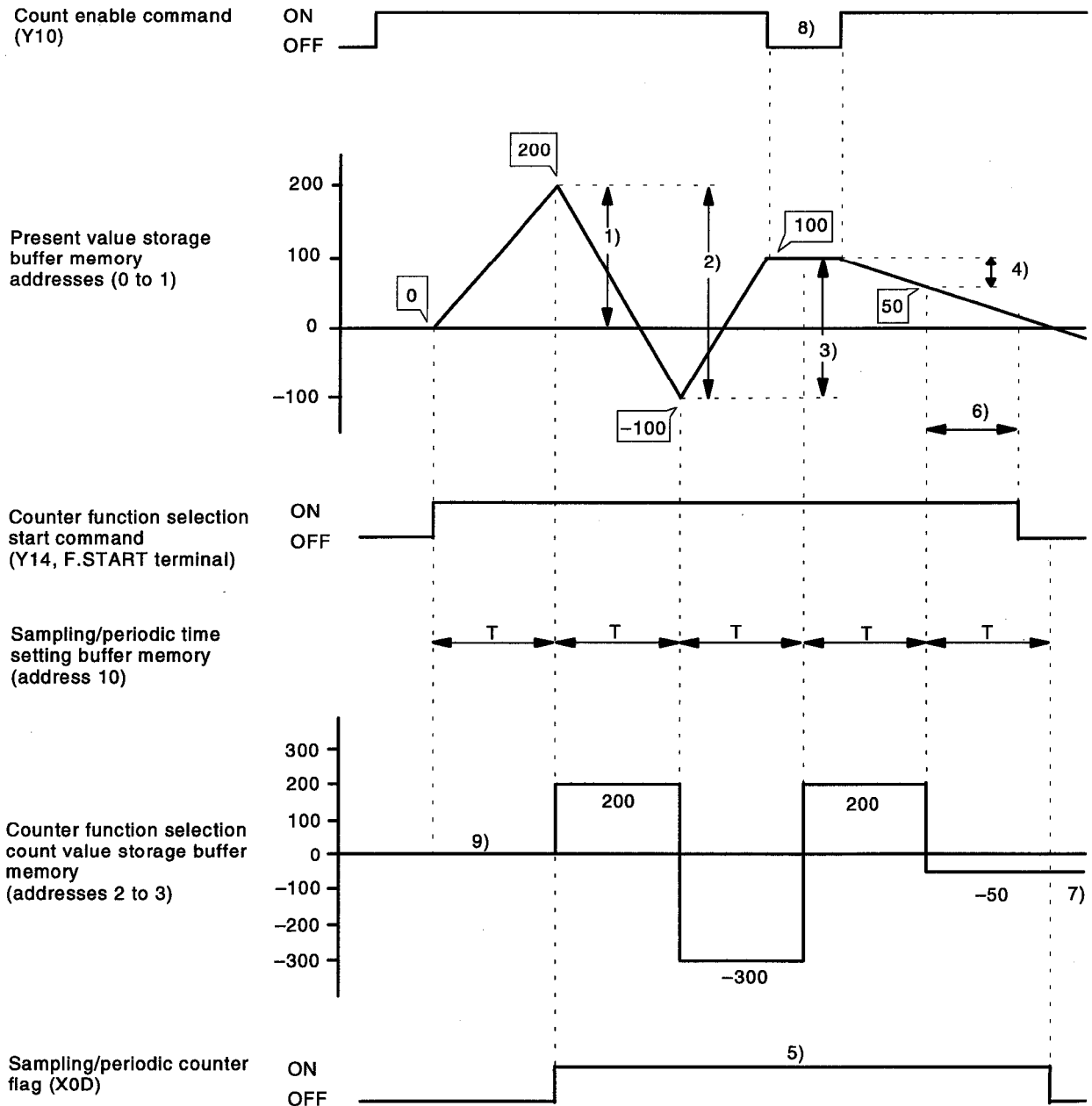

## 9. SELECTING AND EXECUTING THE COUNTER FUNCTION **MELSEC-A**

- 1) Stores the counter present value ( $200 - 0 = 200$ ) to the counter function selection count value storage buffer memory, after the periodic time (set in address 10).
- 9) is set to the "0" state.
- 2) Stores the counter present value of  $-300$  to the counter function selection count value storage buffer memory.
- 3) Stores the counter present value of  $200$  to the counter function selection count value storage buffer memory.
- 4) Stores the counter present value of  $-50$  to the counter function selection count value storage buffer memory.
- 5) Keeps the sampling/periodic counter flag (X0D) ON during execution of the periodic pulse counter.
- 6) Ignores the counter value of the periodic pulse, since the counter function selection start command is turned OFF.
- 7) Retains the value of  $-50$  [item 4] after the periodic pulse counter is executed.
- 8) The periodic pulse counter function works whether the count enable command (Y10) is ON or OFF.



# 9. SELECTING AND EXECUTING THE COUNTER FUNCTION MELSEC-A

## 9.4.1 Example program

The following program allows the A1SD61 to count 2-phase input pulses multiplied by one and execute the periodic pulse counter function.

[System configuration]

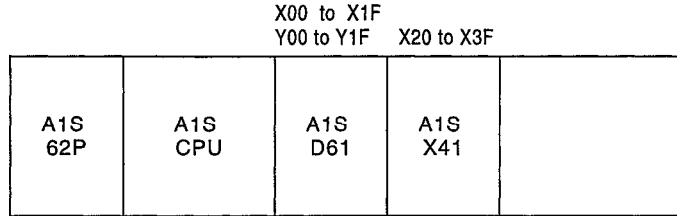

[Devices to be used]

(1) Execution commands

- (a) Pulse input mode setting command.....M9038
- (b) Count operation start command .....X20
- (c) Present value read command .....X21
- (d) Counter function selection count value read command.....X22
- (e) Counter function selection setting command .....X23
- (f) Periodic time setting command .....X24
- (g) Periodic pulse counter command .....X25
- (H) Error reset command .....X26
- (i) Count operation stop command .....X27

(2) Relationship between the data register (D0 to D7) and the buffer memory

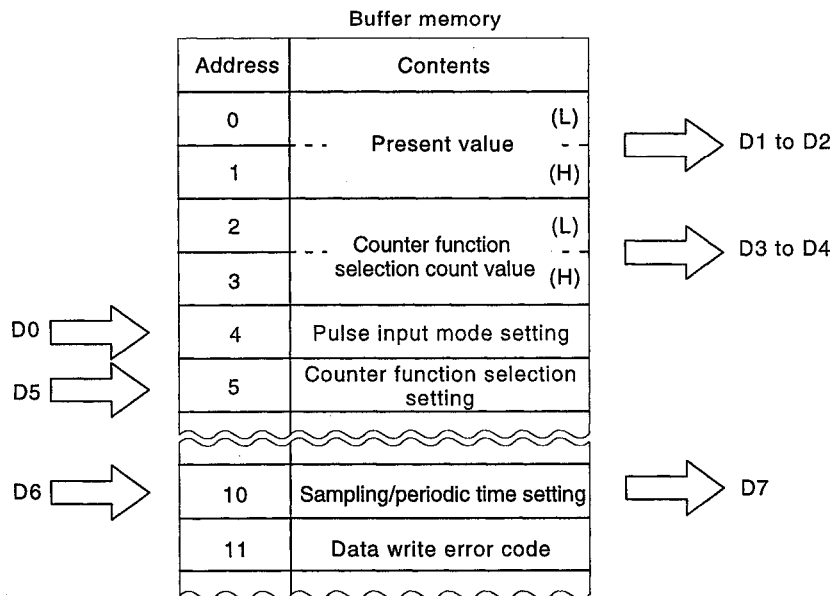

# 9. SELECTING AND EXECUTING THE COUNTER FUNCTION

MELSEC-A

[Example program]

## Pulse input mode setting

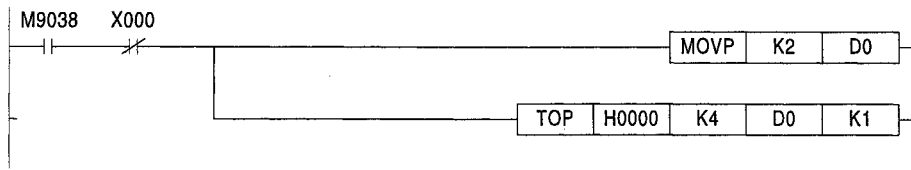

Set the pulse input mode of the 2-phase pulse input multiplied by one.

## Count operation start

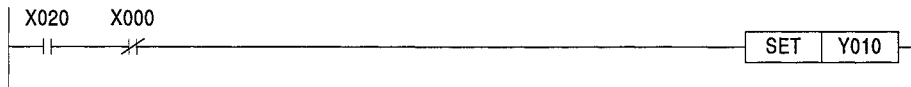

Start the pulse count with the count enable command (SET).

## Present value read



Read the present value and store it to devices D1 to D2.

## Periodic pulse counter command

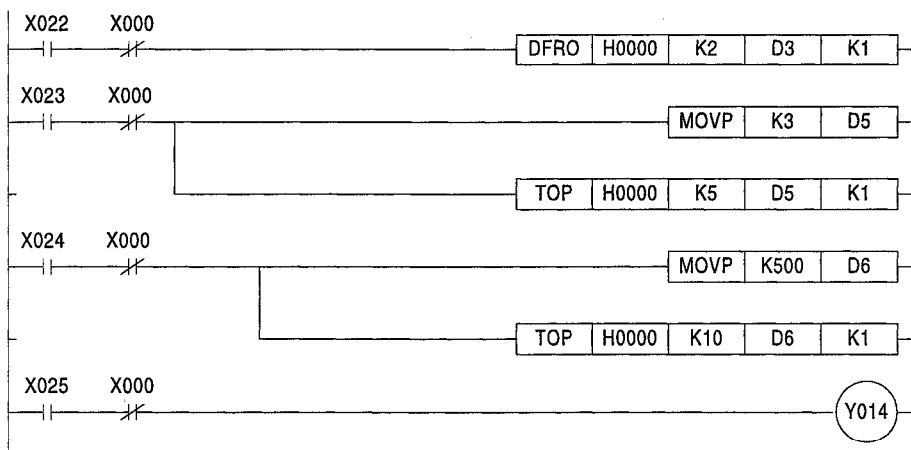

Read the counter function selection counter value and store it to devices D3 to D4.

Set the periodic pulse counter function.

Set the periodic time.

Execute the periodic pulse counter.

## Error detection/reset

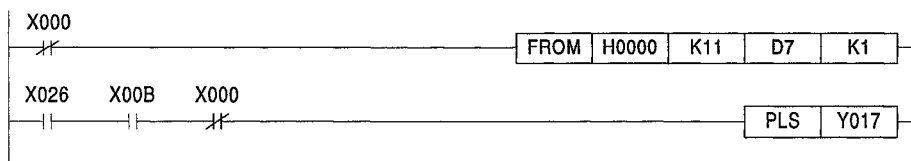

Read the error code and store it to device D7.

Reset the error.

## Count operation stop

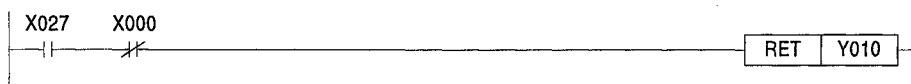

Stop the pulse count with the count enable command (RST).

CIRCUIT END

## 9. SELECTING AND EXECUTING THE COUNTER FUNCTION

MELSEC-A

### 9.5 Count Disable Function

Stop the count operation while the count enable command is ON.

The relationships between the count enable command and the counter function selection start command and between them and the counter present value are shown below:

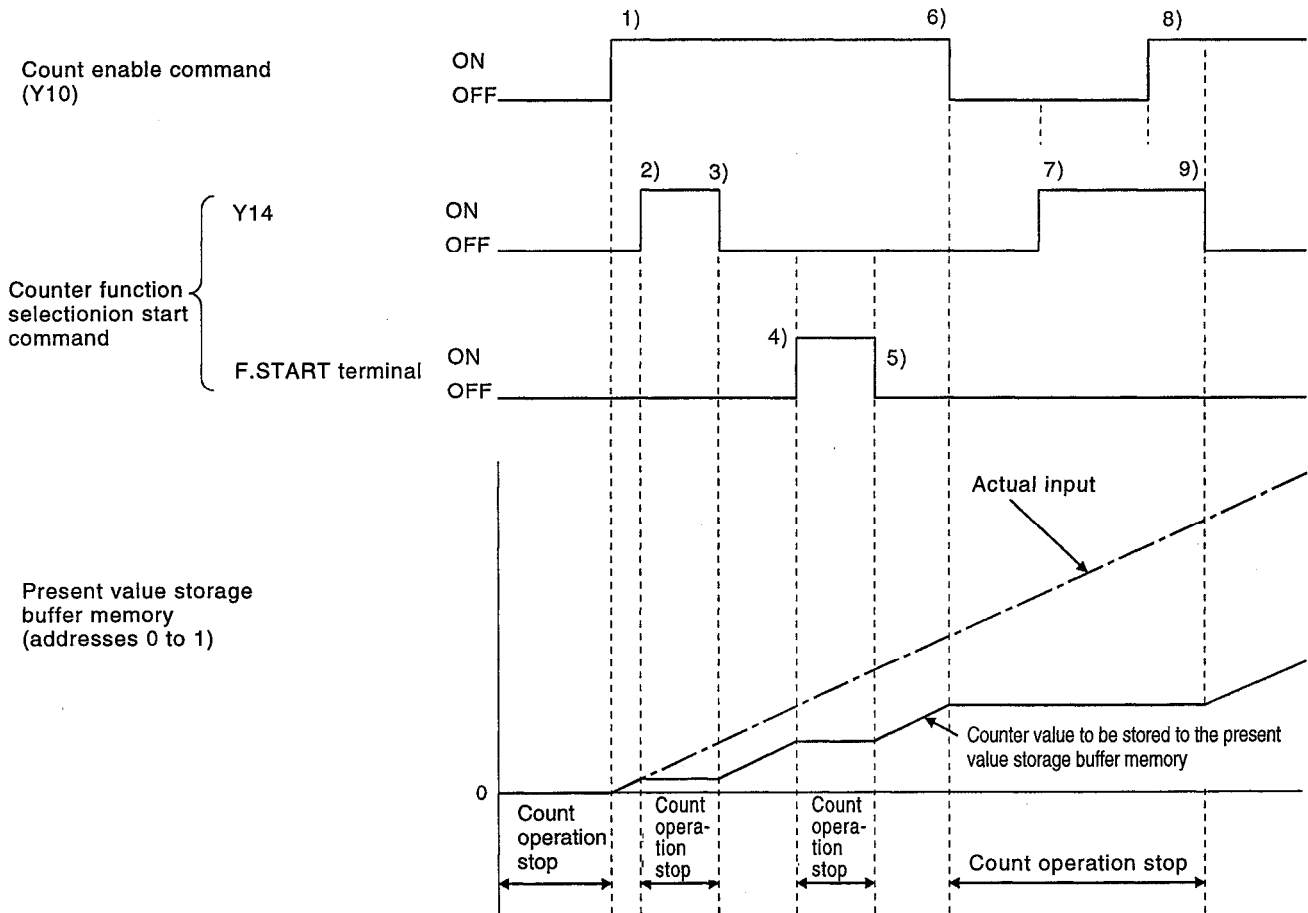

- 1) Starts counting pulses when the count enable command (Y10) is turned ON.
- 2) Stops counting when the counter function selection start command (Y14) is turned ON.
- 3) Resumes the counting when the counter function selection start command (Y14) is turned OFF.
- 4) Stops counting when the counter function selection start command (F.START terminal) is turned ON.
- 5) Resumes the counting when the counter function selection start command (F.START terminal) is turned OFF.
- 6) Stops the counting when the count enable command (Y10) is turned OFF.
- 7) Stops counting independently of the counter function selection start command (Y14), since the count enable command (Y10) is OFF.
- 8) Continues to stop the counting even when the count enable command (Y10) is turned ON, since the counter function selection start command (Y14) is ON.
- 9) Resumes the counting when the counter function selection start command (Y14) is OFF.

# 9. SELECTING AND EXECUTING THE COUNTER FUNCTION

MELSEC-A

## 9.5.1 Example program

The following program allows the A1SD61 count 2-phase input pulses multiplied by one and execute the count disable function.

[System configuration]

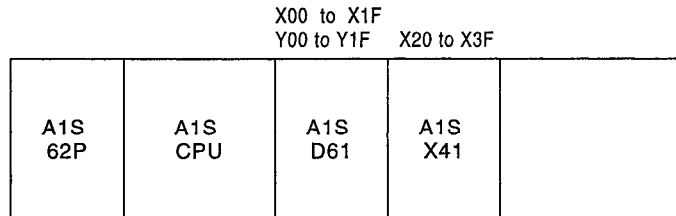

[Devices to be used]

(1) Execution commands

- (a) Pulse input mode setting command.....M9038
- (b) Count operation start command.....X20
- (c) Present value read command.....X21
- (d) Count disable start command.....X22
- (e) Count disable stop command.....X23
- (f) Error reset command.....X24
- (g) Count operation stop command.....X25

(2) Relationship between the data register (D0 to D4) and the buffer memory

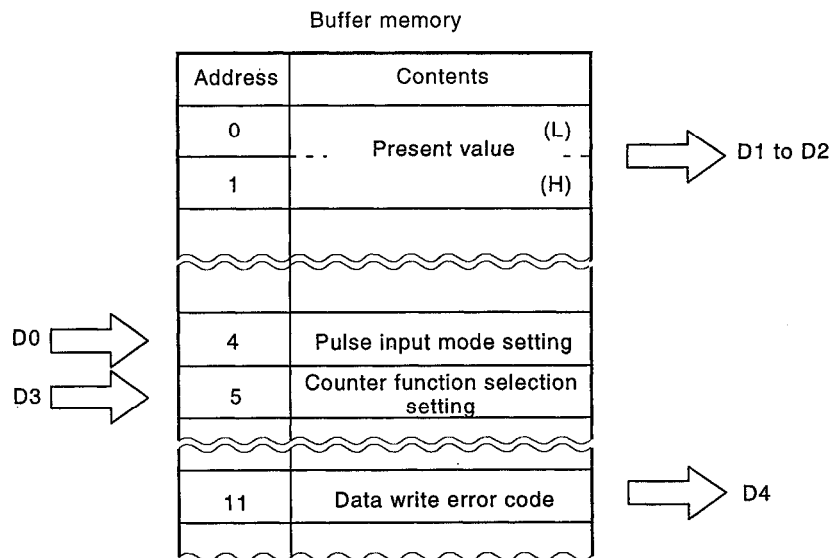

# 9. SELECTING AND EXECUTING THE COUNTER FUNCTION

MELSEC-A

[Example program]

## Pulse input mode setting

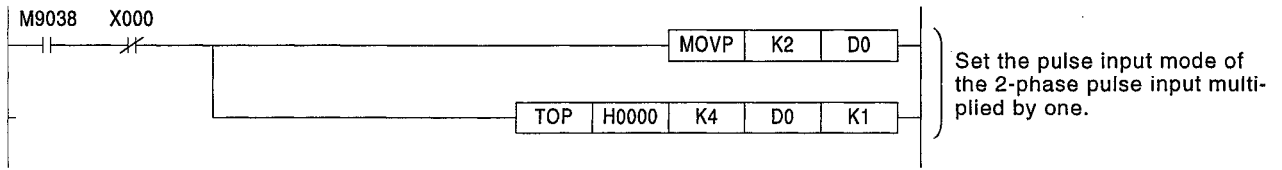

## Count operation start



## Present value read

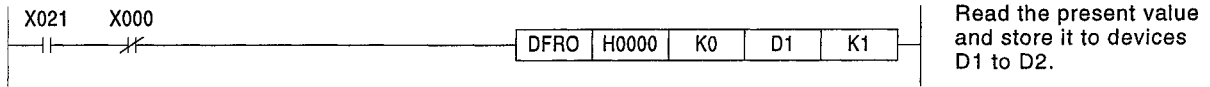

## Count disable command

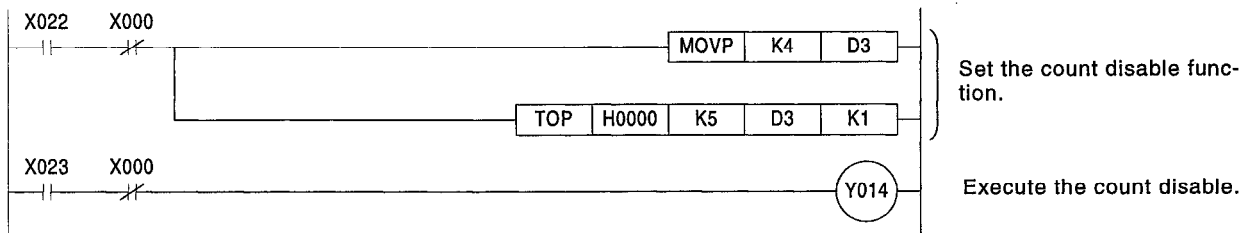

## Error detection/reset

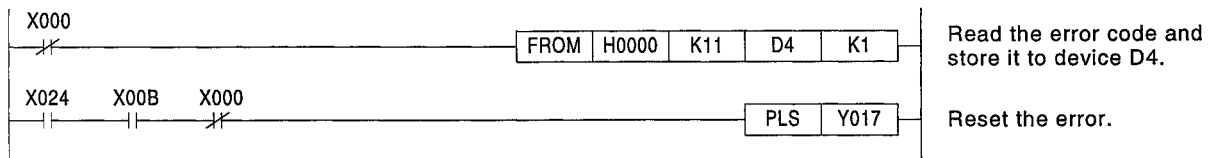

## Count operation stop

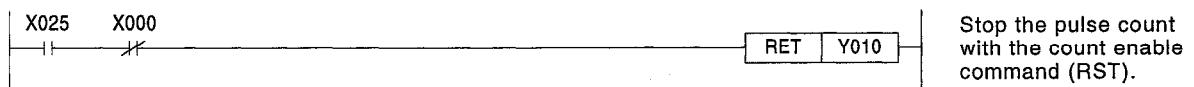

CIRCUIT END

## 10. TROUBLESHOOTING

This section explains the A1SD61 error codes, LED indication, and troubleshooting for the count operation errors.

### 10.1 Error Codes

- (1) When the FROM/TO instruction is executed, if an error occurs (RUN LED flashes), the corresponding error code number will be stored to the error code storage buffer memory (address 11) as shown in table 10.1:

**Table 10.1 Error Codes**

Error Code	Cause	Corrective Action
10	A value outside the range of 0 to 4 was set to the pulse input mode setting buffer memory (address 4).	See section 5, and set a value from 0 to 4.
11	A value outside the range of 0 to 4 was set to the counter function selection setting buffer memory (address 5).	See section 9, and set a value from 0 to 4.
12	"0" was set to the sampling/periodic time setting buffer memory (address 10).	Set a value within the range of 1 to 65535.
13	The preset value is the same as the ring counter value.	Set the values so that they are not the same.
14	A preset value or coounter value was written do the buffer memory while the ring counter command (Y13) was ON.	Turn OFF the ring counter command (Y13), cancel the ring counter function, and execute the write.
102	A write operation was attempted to addresses 0 to 3.	Delete the sequence program containing that operation.
1( ) [ ]	The ON/OFF position data setting values of dogs 0 to 3 for a channel are not in ascending order.	Set the limit switch output ON/OFF position data so that the values are in ascending order for each dog.
20( )	A value outside the range of 0 to 4 was set in the multi-dog setting.	Set a value of 0 to 4.

\* The error code is expressed as a decimal number.

( ) indicates a channel containing the first error during an operation.

[ ] indicates a dog containing the first error during an operation.

- (2) When several errors occur during a single operation, only the code number of the first error detected by the A1SD61 is stored.
- (3) Reset the error either by turning ON the error reset command (Y17) or by writing "0" to the data error code storage buffer memory (address 11).

After resetting the error, the RUN LED will stay lit instead of flashing.

## 10.2 RUN LED Flashes or OFF

(1) When the RUN LED flashes:

Check Item	Corrective Action
Does the A1SD61 contain data that cannot be written or read?	Read the error code stored in the A1SD61 buffer memory, and take measures according to the error code listed in section 11.1.

(2) When the RUN LED is OFF:

Check Item	Corrective Action
Was a fault in the hardware (watchdog timer error) detected?	<ul style="list-style-type: none"> <li>• Check to make sure the power is correctly supplied. Try turning the power supply ON and OFF several times. (Also, check if noise influences the hardware.)</li> <li>• If the LED is not lit, the A1SD61 hardware is faulty. Consult your sales representative.</li> </ul>

## 10.3 Counter Value is Incorrect

Check Item	Corrective Action
Is the pulse input mode consistent with the pulse input setting in the buffer memory?	Input pulses consistently with the setting. (see section 5)
Is the sequence program data processed as 32-bit BIN data?	Correct the sequence program so that the data is processed as 32-bit BIN data.
Is a twisted pair wire used as the pulse input wire?	Use a twisted pair wire.
Does noise come in through the ground of the A1SD61?	<ul style="list-style-type: none"> <li>• Disconnect the A1SD61 from the ground.</li> <li>• If the A1SD61 comes in contact with the ground, separate it from the ground.</li> </ul>
Have adequate measures been taken against noise in the panel or noise resulting from the other equipment?	Provide CR surge suppression to magnetic switches, etc.
Is sufficient distance provided between heavy voltage equipment and pulse input line?	Wire the pulse input line independently, and separate wire in panel 150 mm (5.91 in.) or more from power line.
Do the pulses input waveform to the specifications?	Monitor and confirm the input waveform using a synchroscope. If the waveform is not consistent with the specifications, correct the waveform.

## 10.4 Count Cannot be Made

Check Item	Corrective Action
Is the external wiring of $\phi A$ and $\phi B$ correct?	Check the external wiring, and correct it.
When voltage is applied to the pulse input terminals $\phi A$ and $\phi B$ , do the LEDs of $\phi A$ and $\phi B$ go ON?	<ul style="list-style-type: none"> <li>• When the LEDs went ON, check the external wiring and the pulse generator, and take appropriate measures.</li> <li>• When the LEDs did not go ON, the hardware may be faulty. In this case, consult your nearest Mitsubishi representative.</li> </ul>
Is the count enable command (Y10) ON?	Turn ON the count enable command (Y10) with the sequence program.
Does the PLC CPU signal that an error occurred?	When the PLC CPU contains an error, see the troubleshooting section in the PC CPU manual, and verify the correct operation functions.
Is the counter function selection start command (Y14) ON; or is the voltage applied to the F.START terminal?	When the count disable function was set by the counter function selection, turn OFF Y14 or the F.START terminal.



APPENDICES

Appendix 1 COMPARING THE A1SD61 AND AD61(S1)

Table 1 Performance Comparison

Item		Specifications							
		A1SD61		AD61	AD61-S1				
		Counting Speed Setting Pin (50K)	Counting Speed Setting Pin (10K)						
Number of I/O occupied points		32							
Number of channels		1		2					
Count input signal	Phase	1-phase input, 2-phase input							
	Signal level (øA, øB)	<table style="border: none;"> <tr> <td style="border: none;">5 VDC</td> <td rowspan="3" style="border: none;">} 2 to 5 mA</td> </tr> <tr> <td style="border: none;">12 VDC</td> </tr> <tr> <td style="border: none;">24 VDC</td> </tr> </table>					5 VDC	} 2 to 5 mA	12 VDC
5 VDC	} 2 to 5 mA								
12 VDC									
24 VDC									
Counter	Counting speed	1-Phase input	50k pps	10k pps	50k pps	10k pps			
		2-Phase input	50k pps	7k pps	50k pps	7k pps			
	Counting Range	signed 32-bit binary -2147483648 to 2147483647			signed 24-bit binary 0 to 16777215				
	Type	UP/DOWN preset counter + ring counter function							
	Min. Count pulse width (Input rise/fall time should be 5 µsec or less; duty ration is 50 %.)	<p>(1-phase input, 2-phase input)</p>		<p>(1-phase input)</p>		<p>(2-phase input)</p>			
Comparison output	Comparison range	Signed 32-bit binary			Signed 24-bit binary				
	Comparison results	Limit switch output A contact operation: Dog ON address ≤ Counter value ≤ Dog OFF address B contact operation: Dog OFF address ≤ Counter value ≤ Dog ON address			Set value < Counter value Set value = Counter value Set value > Counter value				
External input	Preset	12/24 VDC, 3/6 mA 5 VDC, 5 mA			Preset	12/24 VDC, 3/6 mA 5 VDC, 5 mA			
	Function start				Count disable				
External output	Comparison output	Transistor (open collector) output 12/24 VDC, 0.1 A/point, 0.8 A/common			Match output	Transistor (open collector) output 12/24 VDC, 5mA			
Current consumption (5 VDC)		0.35 A			0.3 A				



# WARRANTY

Please confirm the following product warranty details before using this product.

## 1. Gratis Warranty Term and Gratis Warranty Range

If any faults or defects (hereinafter "Failure") found to be the responsibility of Mitsubishi occurs during use of the product within the gratis warranty term, the product shall be repaired at no cost via the sales representative or Mitsubishi Service Company.

However, if repairs are required onsite at domestic or overseas location, expenses to send an engineer will be solely at the customer's discretion. Mitsubishi shall not be held responsible for any re-commissioning, maintenance, or testing on-site that involves replacement of the failed module.

### [Gratis Warranty Term]

The gratis warranty term of the product shall be for one year after the date of purchase or delivery to a designated place.

Note that after manufacture and shipment from Mitsubishi, the maximum distribution period shall be six (6) months, and the longest gratis warranty term after manufacturing shall be eighteen (18) months. The gratis warranty term of repair parts shall not exceed the gratis warranty term before repairs.

### [Gratis Warranty Range]

- (1) The range shall be limited to normal use within the usage state, usage methods and usage environment, etc., which follow the conditions and precautions, etc., given in the instruction manual, user's manual and caution labels on the product.
- (2) Even within the gratis warranty term, repairs shall be charged for in the following cases.
  1. Failure occurring from inappropriate storage or handling, carelessness or negligence by the user. Failure caused by the user's hardware or software design.
  2. Failure caused by unapproved modifications, etc., to the product by the user.
  3. When the Mitsubishi product is assembled into a user's device, Failure that could have been avoided if functions or structures, judged as necessary in the legal safety measures the user's device is subject to or as necessary by industry standards, had been provided.
  4. Failure that could have been avoided if consumable parts (battery, backlight, fuse, etc.) designated in the instruction manual had been correctly serviced or replaced.
  5. Failure caused by external irresistible forces such as fires or abnormal voltages, and Failure caused by force majeure such as earthquakes, lightning, wind and water damage.
  6. Failure caused by reasons unpredictable by scientific technology standards at time of shipment from Mitsubishi.
  7. Any other failure found not to be the responsibility of Mitsubishi or that admitted not to be so by the user.

## 2. Onerous repair term after discontinuation of production

- (1) Mitsubishi shall accept onerous product repairs for seven (7) years after production of the product is discontinued. Discontinuation of production shall be notified with Mitsubishi Technical Bulletins, etc.
- (2) Product supply (including repair parts) is not available after production is discontinued.

## 3. Overseas service

Overseas, repairs shall be accepted by Mitsubishi's local overseas FA Center. Note that the repair conditions at each FA Center may differ.

## 4. Exclusion of loss in opportunity and secondary loss from warranty liability

Regardless of the gratis warranty term, Mitsubishi shall not be liable for compensation of damages caused by any cause found not to be the responsibility of Mitsubishi, loss in opportunity, lost profits incurred to the user by Failures of Mitsubishi products, special damages and secondary damages whether foreseeable or not, compensation for accidents, and compensation for damages to products other than Mitsubishi products, replacement by the user, maintenance of on-site equipment, start-up test run and other tasks.

## 5. Changes in product specifications

The specifications given in the catalogs, manuals or technical documents are subject to change without prior notice.

## 6. Product application

- (1) In using the Mitsubishi MELSEC programmable logic controller, the usage conditions shall be that the application will not lead to a major accident even if any problem or fault should occur in the programmable logic controller device, and that backup and fail-safe functions are systematically provided outside of the device for any problem or fault.
- (2) The Mitsubishi programmable logic controller has been designed and manufactured for applications in general industries, etc. Thus, applications in which the public could be affected such as in nuclear power plants and other power plants operated by respective power companies, and applications in which a special quality assurance system is required, such as for Railway companies or Public service purposes shall be excluded from the programmable logic controller applications.

In addition, applications in which human life or property that could be greatly affected, such as in aircraft, medical applications, incineration and fuel devices, manned transportation, equipment for recreation and amusement, and safety devices, shall also be excluded from the programmable logic controller range of applications.

However, in certain cases, some applications may be possible, providing the user consults their local Mitsubishi representative outlining the special requirements of the project, and providing that all parties concerned agree to the special circumstances, solely at the users discretion.





# High Speed Counter Module Type A1SD61

## User's Manual

MODEL	A1SD61-USERS-E
MODEL CODE	13J674
IB(NA)-66337-C(0411)MEE	

 **MITSUBISHI ELECTRIC CORPORATION**

HEAD OFFICE : 1-8-12, OFFICE TOWER Z 14F HARUMI CHUO-KU 104-6212, JAPAN  
NAGOYA WORKS : 1-14 , YADA-MINAMI 5-CHOME , HIGASHI-KU, NAGOYA , JAPAN

When exported from Japan, this manual does not require application to the Ministry of Economy, Trade and Industry for service transaction permission.

Specifications subject to change without notice.