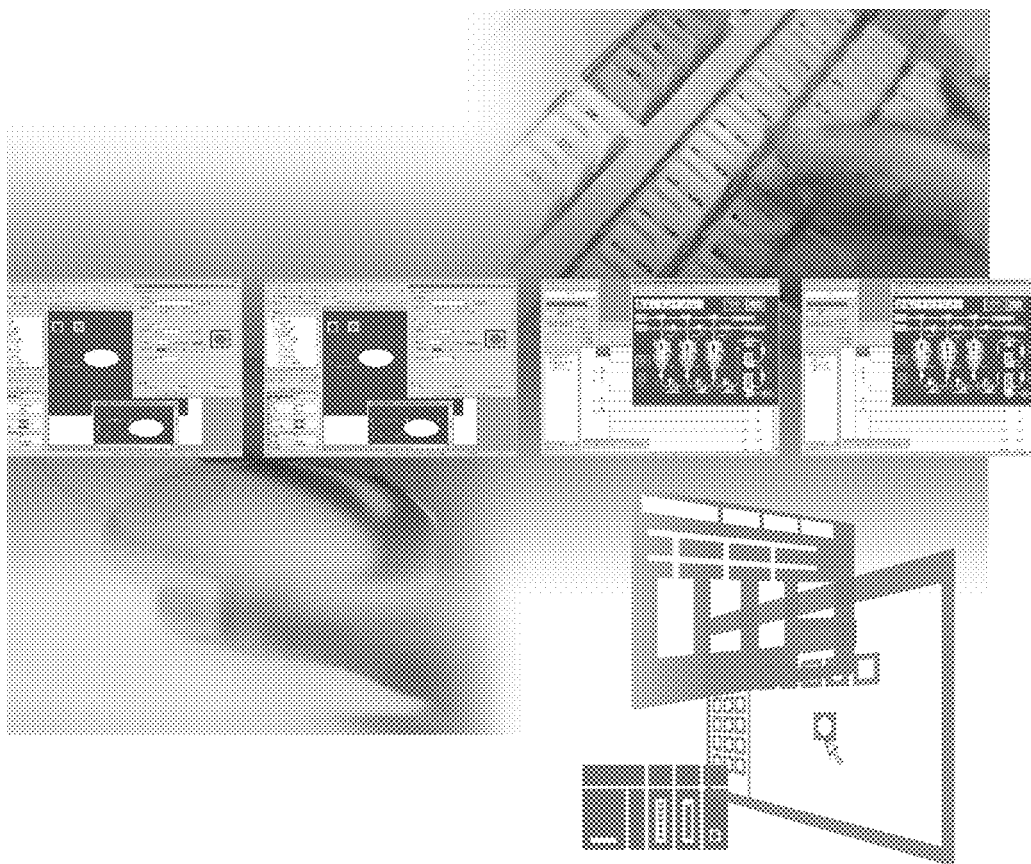


*GT Designer2 Version2*

**Operating Manual**

(For GOT900 Series)

**MITSUBISHI**



MELSOFT MITSUBISHI TOTAL FA SOLUTION

***GT Designer 2***

**MELSOFT**  
**Integrated FA Software**

**SW2D5C-GTWK2-E**  
**SW2D5C-GTD2-E**



# ● SAFETY PRECAUTIONS ●

(Please read it carefully before using this product)

Before using this product, please read carefully the manual and its related manuals introduced thereafter, and pay full attention to the safety to handle the product correctly.

The instructions given in this manual are concerned with this product.


In this manual, the safety instructions are ranked as "DANGER" and "CAUTION".



Indicates that incorrect handling may cause hazardous conditions, resulting in death or severe injury.



Indicates that incorrect handling may cause hazardous conditions, resulting in medium or slight personal injury or physical damage.

Note that the  CAUTION level may lead to serious consequences according to the circumstances.

Always follow instructions of both levels because they are important to personal safety.

## [Test operation precautions]

### **DANGER**

- Please read this manual carefully and understand it thoroughly before executing system monitor, special module monitor, and circuit monitor (bit device on/off, current value change of word device, setting value of timer/counter and current value change, and current value change of buffer memory) During test operation, DO NOT change the devices data that are used to execute important system operations.

Mis-output or mis-operation may cause accidents.

# Cautions for using this software

---

1. Required PC memory

The processing may be terminated by Windows® on a personal computer of which main memory capacity is less than 64M bytes. Make sure to secure the capacity of 64 M bytes or more.

2. Free capacity of hard disk (virtual memory)

At least 100M bytes of free capacity of virtual memory should be secured within hard disk to run this software.

The processing may be terminated by Windows® if 100M bytes or more of free space cannot be secured within hard disk while running GT Designer.

Secure enough free capacity of virtual memory within hard disk space in order to run the software.

When enough free capacity cannot be secured, make sure to save projects frequently.

3. Error messages displayed while starting and editing

"Operation will be terminated because of insufficient memory. Would you like to stop?"

If the above message appears, close other running application software or reboot Windows in order to secure at least 50M bytes of free hard disk space.

4. GT Designer2 and GOT display

(a) Cautions for displaying straight line other than full line (dotted line, for example) in Bold

When straight line other than full line is drawn in bold, the line may not be displayed with its actual line width on a personal computer. However, it will be displayed correctly on GOT. This phenomenon does not mean data problem.

(b) Display of end points of straight line/line freeform/polygon

As shown below, the end points of straight line/line freeform/polygon are displayed differently between GT Designer2 and GOT.

On GT Designer 2



On GOT



(c) Start position for filling patterns

Some filling patterns may be differently displayed. For example, the start position may be different between GT Designer2 and GOT.

(d) Drawing of different type lines

The length of the dots varies in different dotted lines (for example: the chain lines).

(e) Display of object

The display position of the memory data display in graph function is different between GT Designer2 and GOT.

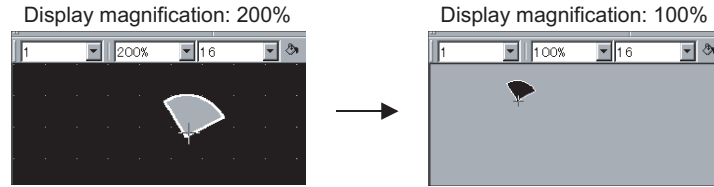
Even if the display-start-line of a comment has been set, the comment will be displayed from the first line on GT Designer2.

(f) Display magnification

When display magnification is changed, the connected lines or figures may be separated or the filled-paint may be out of outline of the figure.

However, if they are displayed correctly on the preview screen, they will appear correctly on GOT as well.

(Example): When filled-paint is out of the outline.



Position of Paint mark may be shifted and the filled-paint may be out of the figure outline.

5. Restrictions when the color setting is changed to the setting of less colors in the system environment (256 colors → 2 colors)

- The color palette for setting color will be changed according to the updated settings.
- The color on the drawing screen will be kept the same as prior to the change.  
If the color setting for a [red] rectangle-figure is changed to the 2 colors (B/W), the [red] color will remain.
- The colors of the image data (BMP format file) will be reduced when the project is stored, the screen is closed and that image data is double-clicked.

6. Object function and device type

The object (bit lamp or word lamp), for which bit device setting and word device setting are separated, cannot be converted between bit device and word device.

7. When device type is changed

Confirm the device type when the set bit device is changed from bit device into word device.

The device flag may be represented as "??", depending on the settings .

(Example) D0.b0 → D0      D0.b5 → ??

8. OS setting

Set the font size as "Small Font" when setting OS (Windows®) screen.

The GT designer2 dialog box cannot be displayed correctly if the font size is set as "Large font".

9. When the toolbar icon appears in smaller size after startup of GT Designer2

The toolbar icon may appear in smaller size right after GT Designer2 is started up.

To correctly display the icon, initialize it as instructed below.

(Click on [Project] → [References] from the menu, and select the toolbar tab. Click on **Reset All** button in that tab.)



10. When using GT Designer2 in the PC in which the OS other than Japanese version

The text may not be displayed correctly depending on the OS versions; some version include the fonts incompatible with GT Designer2 or GOT.

11. When using Microsoft® Narrator

GT Designer2 cannot be used with Microsoft® Narrator.

When using GT Designer2, do not use Microsoft® Narrator.

# REVISIONS

\*The manual number is given on the left bottom of the back cover.

Print Date	Manual Number	Revision
Oct., 2004	SH (NA)-080521ENG-A	First edition
Mar., 2005	SH (NA)-080521ENG-B	<p><b>Partial corrections</b></p> <p>Section 2.1.2, 3.1.1, 3.1.2, 3.2, 3.4.1, 3.6, 4.3.1, 4.7.1, 4.10.1, 4.11.1, 4.11.2, 4.12, 5.2.3, 5.2.4, 5.2.5, 5.3.1, 5.3.2, 6.1.2, 7.1, 7.1.2, 7.2, 7.3, 7.3.2 to 7.3.7, 8.1.2, 9.1.4, 9.2.1, 9.4.1, Appendix 2</p> <p><b>Additions</b></p> <p>Section 1.2.1, 1.2.2, 7.3.8</p>
Oct., 2005	SH (NA)-080521ENG-C	<p><b>Partial corrections</b></p> <p>Section 1.2, 1.2.2, 3.1.2, 3.4.2, 3.4.3, 3.2, 3.6, 4.1, 4.2, 4.7.4, 4.7.5, 4.10, 4.10.1, 4.10.2, 4.12, 4.13, 6.1.2, 7.1.1, 7.1.2, 7.2, 7.3.1, 7.3.2, 7.3.3, 7.3.4, 7.3.5, 7.3.6, 7.3.7, 7.3.8, 8.1.3, 9.1.4, 9.3</p>
Janu., 2006	SH (NA)-080521ENG-D	<p><b>Partial corrections</b></p> <p>Section 4.7, Section 6.1, Section 9.1</p>
Jun., 2006	SH (NA)-080521ENG-E	<p><b>Partial corrections</b></p> <p>Section 4.2, Section 4.3.1, Section 4.7.1, Appendix 3.1</p> <p><b>Additions</b></p> <p>Section 8.2.6</p>
Nov., 2006	SH (NA)-080521ENG-F	<p><b>Partial corrections</b></p> <p>Section 1.2, Section 3.1, Section 3.2, Section 3.3, Section 3.4, Section 4.7, Section 4.9, Section 4.11, Section 7.3, Section 9.1, Appendix 1</p> <p><b>Additions</b></p> <p>Section 8.1.4</p>
Dec., 2006	SH (NA)-080521ENG-G	<p><b>Partial corrections</b></p> <p>Section 4.3.1, Section 4.14.2</p>
Feb., 2007	SH (NA)-080521ENG-H	<p><b>Partial corrections</b></p> <p>Section 3.4.3</p>
May., 2007	SH (NA)-080521ENG-I	<p><b>Partial corrections</b></p> <p>Section 1.2.1, 3.1.1, 3.2, 3.3.1, 3.4.1, 3.4.3, 4.7.4, 4.9, 4.11.1, 4.11.2, 5.1.2, 5.2.2, 5.2.3, 5.2.6, 5.3.2, 7.1.1, 7.2, 7.3.1, 7.3.2, 7.3.3, 7.3.4, 7.3.6, 7.3.7, 7.3.8, Appendix 2</p>
Aug., 2007	SH (NA)-080521ENG-J	<p><b>Partial corrections</b></p> <p>Section 3.4.3, 4.1, 4.6.1, 5.1.2, 5.2.2</p>
Dec., 2007	SH (NA)-080521ENG-K	<p><b>Partial corrections</b></p> <p>Section 2.1.2, 3.2, 4.7.4, 9.1.5, 9.6.2, Appendix 2</p>
Feb., 2008	SH (NA)-080521ENG-L	<p><b>Partial corrections</b></p> <p>Section 8.1.4, 8.1.5</p>
Jun., 2008	SH (NA) -080521ENG-M	<p><b>Partial corrections</b></p> <p>Sections 2.1.2, 3.6</p>

\*The manual number is given on the left bottom of the back cover.

Print Date	Manual Number	Revision
Oct., 2008	SH (NA)-080521ENG-N	Partial corrections Section 2.1, 3.2, 3.3, 3.4, 8.2, 9.1
Mar., 2009	SH (NA)-080521ENG-O	Partial corrections Section 4.10, 3.2, Appendix 3

Japanese Manual Version SH-080514-Q

This manual confers no industrial property rights or any other kind, nor does it confer any patent licenses. Mitsubishi Electric Corporation cannot be held responsible for any problems involving industrial property rights which may occur as a result of using the contents noted in this manual.

© 2004 MITSUBISHI ELECTRIC CORPORATION

# INTRODUCTION

---

Thank you for choosing Mitsubishi Graphic Operation Terminal (Mitsubishi GOT).

Read this manual and make sure you understand the functions and performance of the GOT thoroughly in advance to ensure correct use.

# CONTENTS

---

SAFETY PRECAUTIONS.....	A - 1
Cautions for using this software .....	A - 2
REVISIONS .....	A - 4
INTRODUCTION.....	A - 6
CONTENTS.....	A - 6
Function Quick Reference.....	A - 10
Manuals.....	A - 18
ABBREVIATIONS AND GENERIC TERMS.....	A - 19
How to Use This Manual .....	A - 23
Product List.....	A - 24
<b>1. OVERVIEW.....</b>	<b>1 - 1 to 1 - 7</b>
1.1 Overview.....	1 - 1
1.2 Feature .....	1 - 3
1.2.1 Easy-to-use operations.....	1 - 3
1.2.2 Useful functions .....	1 - 5
<b>2. SYSTEM CONFIGURATION .....</b>	<b>2 - 1 to 2 - 6</b>
2.1 System Configuration in Creating Monitor Screen .....	2 - 1
2.1.1 System configuration .....	2 - 1
2.1.2 Operating environment .....	2 - 1
2.2 System Configuration of Data Transfer and Document Creation .....	2 - 3
2.2.1 System configuration .....	2 - 3
2.2.2 RS-232 cable to be used .....	2 - 5
<b>3. SCREEN CONFIGURATION OF GT DESIGNER 2</b>	<b>3 - 1 to 3 - 36</b>
.....	3 - 1 to 3 - 36
3.1 Screen Configuration and Basic Operation .....	3 - 1
3.1.1 Screen configuration and various tools .....	3 - 1
3.1.2 Operation of workspace.....	3 - 4
3.2 Menu Configuration .....	3 - 8
3.3 Toolbars.....	3 - 11
3.3.1 Types of toolbars .....	3 - 11



3.4 Customizing Screen Configuration and Toolbars.....	3 - 19
3.4.1 Customizing screen configuration.....	3 - 20
3.4.2 Customizing toolbars .....	3 - 22
3.4.3 Customizing GT Designer2 operating environment.....	3 - 26
3.4.4 Display with frame .....	3 - 32
3.4.5 Redisplaying drawing screen.....	3 - 33
3.5 How to use Help.....	3 - 34
3.6 How to View the Product Information.....	3 - 36

## 4. CREATING AND EDITING SCREEN ..... 4 - 1 to 4 - 58

4.1 Selecting Project at the Start of GT Designer2 .....	4 - 1
4.2 Creating a New Project .....	4 - 3
4.3 Opening/Closing Project .....	4 - 9
4.3.1 Opening project .....	4 - 9
4.3.2 Closing project.....	4 - 11
4.4 Setting the Project Title .....	4 - 12
4.5 Creating a New Screen .....	4 - 13
4.6 Opening/Closing Screen .....	4 - 17
4.6.1 Opening screen .....	4 - 17
4.6.2 Closing screen.....	4 - 21
4.7 Basic Operations of Drawing Screen (Editor) .....	4 - 22
4.7.1 Object placement area and display area on GOT .....	4 - 22
4.7.2 Basic operations for object placement.....	4 - 24
4.7.3 Figure drawing/text input .....	4 - 26
4.7.4 Object function setting .....	4 - 28
4.7.5 Basic operations of dialog box.....	4 - 36
4.8 Operating Multiple Screens .....	4 - 38
4.8.1 Cascading/tiling screens.....	4 - 38
4.8.2 Making editing screen active .....	4 - 39
4.9 Changing Screen Property.....	4 - 40
4.10 Viewing Created Screen Image .....	4 - 43
4.10.1Previewing the Base Screen.....	4 - 43
4.10.2Previewing the Base Screen with window .....	4 - 46
4.11 Copying/Deleting Screen .....	4 - 48
4.11.1Copying screen data .....	4 - 48
4.11.2Deleting screen data.....	4 - 50
4.12 Setting Screen Switching Device .....	4 - 52
4.13 Data Check .....	4 - 54
4.14 Saving Project .....	4 - 56
4.14.1Overwriting and saving project.....	4 - 56
4.14.2Saving as project name .....	4 - 56
4.15 Ending GT Designer2.....	4 - 58

## 5. DATA TRANSFER OPERATION ..... 5 - 1 to 5 - 39

5.1 Type and Size of Transfer Data to GOT .....	5 - 1
5.1.1 Data type to be installed on GOT .....	5 - 1
5.1.2 Memory space required for data transfer.....	5 - 8

5.2 Transferring data with RS-232 cable .....	5 - 13
5.2.1 Setting communication .....	5 - 18
5.2.2 Getting built-in memory information .....	5 - 19
5.2.3 Uploading.....	5 - 20
5.2.4 Installing ROM_BIOS.....	5 - 21
5.2.5 Installing OS .....	5 - 24
5.2.6 Downloading monitor data .....	5 - 26
5.2.7 Downloading special data .....	5 - 28
5.3 Transferring Data Using Memory Card.....	5 - 29
5.3.1 Installing ROM_BIOS.....	5 - 31
5.3.2 Transferring OS, monitor data and special data .....	5 - 34
5.4 Error Message for Data Transfer.....	5 - 37
<b>6. PRINTING PROJECT/FILE OUTPUT .....</b>	<b>6 - 1 to 6 - 14</b>
6.1 Printing method .....	6 - 1
6.1.1 Setting method.....	6 - 1
6.1.2 Setting items .....	6 - 2
6.2 Printing example .....	6 - 9
6.2.1 Printer output .....	6 - 9
6.2.2 File output .....	6 - 13
<b>7. USING LIBRARY .....</b>	<b>7 - 1 to 7 - 21</b>
7.1 What is Library?.....	7 - 1
7.1.1 What you need to know before using library .....	7 - 1
7.1.2 Basic operation of library .....	7 - 4
7.2 Pasting Objects or Figures from Library.....	7 - 6
7.3 Creating Original Library.....	7 - 7
7.3.1 Registering objects or figures on library .....	7 - 7
7.3.2 Copying registered library/template .....	7 - 9
7.3.3 Deleting registered library/template .....	7 - 10
7.3.4 Editing registered objects and figures.....	7 - 11
7.3.5 Changing library property .....	7 - 13
7.3.6 Saving library .....	7 - 14
7.3.7 Loading library from file .....	7 - 17
7.3.8 Importing user library .....	7 - 19
7.4 Utilizing Panelkit of GT Designer.....	7 - 21
<b>8. DRAW AND EDIT .....</b>	<b>8 - 1 to 8 - 34</b>
8.1 Drawing Figures .....	8 - 1
8.1.1 Drawing figures.....	8 - 1
8.1.2 Entering text .....	8 - 6
8.1.3 Painting figures .....	8 - 8
8.1.4 Capture function .....	8 - 10
8.1.5 Pasting figure data of BMP file .....	8 - 13

8.2 Editing Figure and Object.....	8 - 18
8.2.1 Selecting figure and object .....	8 - 18
8.2.2 Editing figures and objects.....	8 - 20
8.2.3 Grouping/Ungrouping multiple figures and objects.....	8 - 21
8.2.4 Undo and redo .....	8 - 21
8.2.5 Aligning figures and objects.....	8 - 22
8.2.6 Enlarging or reducing multiple figures and objects .....	8 - 27
8.2.7 Changing attributes of figures and objects .....	8 - 28
8.2.8 Changing size of figures/objects.....	8 - 30
8.2.9 Copying figures and objects consecutively.....	8 - 32
8.2.10 Copying figures and objects.....	8 - 34

## 9. USEFUL FUNCTIONS ..... 9 - 1 to 9 - 39

9.1 Edit Function .....	9 - 1
9.1.1 Batch setting of multiple objects/figures on the same screen (Property sheet).....	9 - 1
9.1.2 Batch setting and managing objects/figures for each purpose (Category workspace).....	9 - 5
9.1.3 Batch editing attributes of objects/figures scattered on multiple screens (Batch edit).....	9 - 12
9.1.4 Simple selection of overlapped figure (Data view).....	9 - 16
9.1.5 Checking devices in use (Device List).....	9 - 17
9.1.6 Checking Text in use (Text String List).....	9 - 19
9.2 Referring to Device Comment When Setting Devices .....	9 - 21
9.2.1 Importing device comment.....	9 - 21
9.2.2 Check method of device comment .....	9 - 23
9.3 Checking Monitor Data for Errors.....	9 - 25
9.4 Inputting multiple language .....	9 - 26
9.4.1 Input method.....	9 - 27
9.4.2 Precautions.....	9 - 33
9.5 Confirming the created data size .....	9 - 34
9.5.1 Confirmation method .....	9 - 34
9.5.2 Confirmation items.....	9 - 34
9.6 Utilizing other project data.....	9 - 35
9.6.1 Importing data.....	9 - 35
9.6.2 Cautions.....	9 - 36

## APPENDIX ..... App - 1 to App - 15

Appendix 1	List of Shortcut Keys .....	App- 1
Appendix 2	Q&A of GT Designer2 Operation .....	App- 3
Appendix 3	Using Existing Data .....	App- 6
Appendix 3.1	Outline procedures.....	App- 6
Appendix 3.2	Precautions.....	App- 7
Appendix 4	Applicable Monitor Data .....	App- 11
Appendix 4.1	Opening monitor data .....	App- 12
Appendix 4.2	Uploading monitor data.....	App- 12
Appendix 4.3	Downloading monitor data .....	App- 13
Appendix 4.4	Copying monitor data from one GOT unit to other unit with a PC card.....	App- 14

## INDEX ..... Index - 1 to Index - 2

# Function Quick Reference

## Edit Operation (GT Designer2 Version□ Operating Manual)

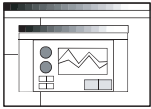


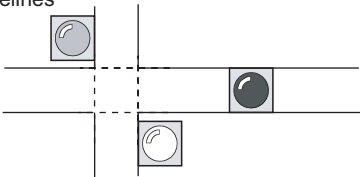
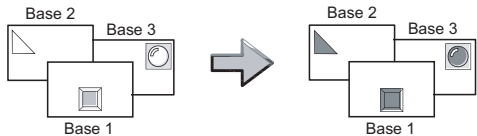
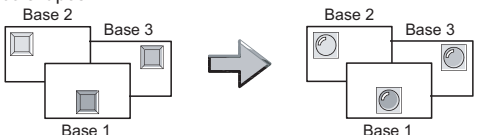

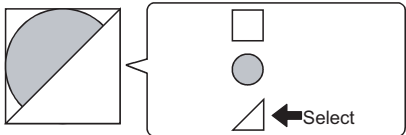
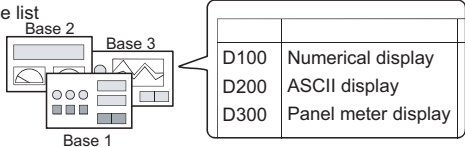
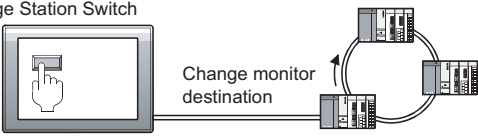
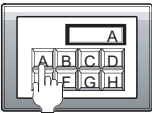
Image	Function	Page						
<p>Preview</p> 	<p>Show the preview of screen image of GOT.</p>	<p>Page 4-43</p>						
<p>Align</p> 	<p>Aligns objects or images</p>	<p>Page 8-22</p>						
<p>Property sheet</p> 	<p>Sets same attributes to objects or images in the same screen</p>	<p>Page 9-1</p>						
<p>Guidelines</p> 	<p>Displays lines to align figures and objects when arranging a placed figure or object.</p>	<p>Page 8-25</p>						
<p>Replace colors</p> 	<p>Changes the color(s) of the objects and figures arranged on plural screens at the same time</p>	<p>Page 9-12</p>						
<p>Replace shapes</p> 	<p>Changes the switch/lamp figures at the same time</p>	<p>Page 9-12</p>						
<p>Replace devices</p> 	<p>Changes the preset devices at the same time</p>	<p>Page 9-12</p>						
<p>Data View</p> 	<p>Overlapping images or objects</p>	<p>Page 9-16</p>						
<p>Device list</p>  <table border="1" data-bbox="384 1839 643 1984"> <tr> <td>D100</td> <td>Numerical display</td> </tr> <tr> <td>D200</td> <td>ASCII display</td> </tr> <tr> <td>D300</td> <td>Panel meter display</td> </tr> </table>	D100	Numerical display	D200	ASCII display	D300	Panel meter display	<p>Display the set device in list</p>	<p>Page 9-17</p>
D100	Numerical display							
D200	ASCII display							
D300	Panel meter display							

Image	Function	Page
<p>Text list</p>	Displays the direct input texts in a list.	Page 9-19
<p>Multiple language input</p>	Input characters or comments in other language.	Page 9-26
<p>Import BMP/DXF file</p>	Imports BMP/DXF files	Page 8-13
<p>Import Project</p>	Utilizes other project data	Page 9-35

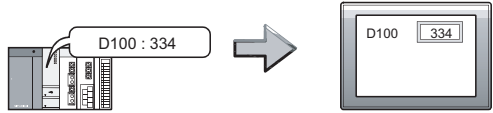
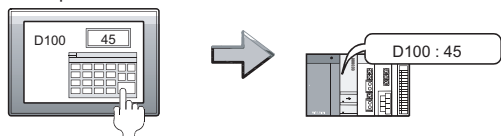
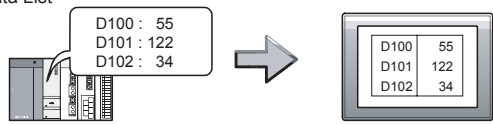
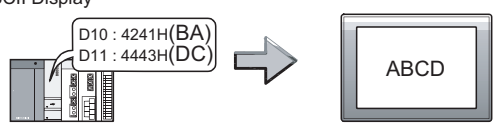
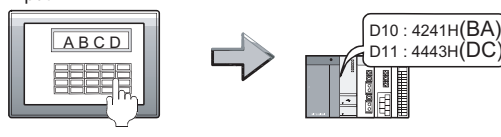
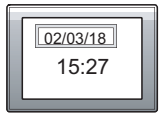

## Object Functions (GT Designer2 Version□ Reference Manual)

### 1 Lamp, Touch Switch


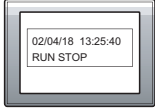

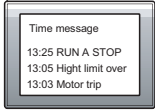

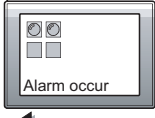
Image	Function	Page
<p>Lamp</p>	Displays device value via lamp color changing	Page 6-1
<p>Bit Switch</p>	Touch it to switch device ON/OFF	Page 6-19
<p>Data Set Switch</p>	Touch it to change bit device value	Page 6-36
<p>Special Function Switch</p>	Touch it to switch to the extended function screen	Page 6-41
<p>GO TO Screen Switch</p>	Touchitto switch between the base and window screen	Page 6-49

Image	Function	Page
<p>Change Station Switch</p> 	Touch it to switch the monitored PLC station No.	Page 6-59
<p>Key Code Switch</p> 	Used as the key for inputting numerical value/ASCII	Page 6-65

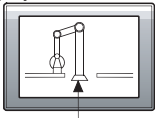
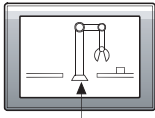
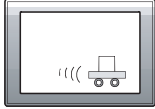
## 2 Digit/Font Display

Image	Function	Page
<p>Numerical Display</p> 	Displays device value in numerical value	Page 7-1
<p>Numerical Input</p> 	Write value on device	Page 7-1
<p>Data List</p> 	Display multiple device value in list	Page 7-28
<p>ASCII Display</p> 	Displays device value in text	Page 7-44
<p>ASCII Input</p> 	Inputs text code device	Page 7-44
<p>Clock Display</p> 	Displays hour/minutes, year/month/date	Page 7-57
<p>Comment Display</p> 	Displays command	Page 7-63



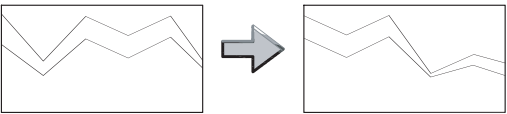
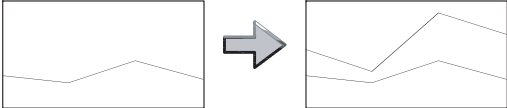
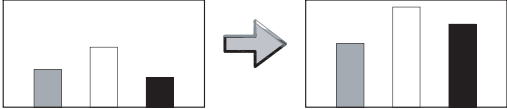


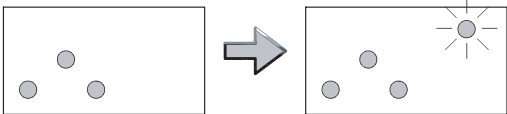

### 3 Alarm

Image	Function	Page
<p>Alarm List</p>  <p>→</p> 	<p>Displays message at alarm occurrence</p>	<p>Page 8-1</p>
<p>Alarm History</p>  <p>→</p> 	<p>Displays alarm history</p>	<p>Page 8-31</p>
<p>Floating Alarm</p>  <p>→</p>  <p>←</p>	<p>Displays alarm in floating</p>	<p>Page 8-67</p>

### 4 Parts

Image	Function	Page
<p>Parts Display</p>  <p>→</p> 	<p>Display entered device</p>	<p>Page 9-1</p>
<p>Parts Movement</p> 	<p>Displays moving parts</p>	<p>Page 9-28</p>

## 5 Graph, Meter

Image	Function	Page
<p>Panel meter</p> 	<p>Displays device data on panel meter</p>	<p>Page 10-1</p>
<p>Level</p> 	<p>Displays device data in proportional level</p>	<p>Page 10-14</p>
<p>Trend Graph</p> 	<p>Displays device data in trend graph</p>	<p>Page 10-28</p>
<p>Line Graph</p> 	<p>Displays device data in line graph</p>	<p>Page 10-44</p>
<p>Bar Graph</p> 	<p>Displays device data in bar graph</p>	<p>Page 10-59</p>
<p>Statistics Graph</p> <p>Pie Graph</p>  <p>Bar Graph</p> 	<p>Displays device data in statistics graph</p>	<p>Page 10-71</p>
<p>Scatter Graph</p> 	<p>Displays device data in scatter graph</p>	<p>Page 10-81</p>
<p>Sampling</p> 	<p>Collect the device value and edit collected data on PC</p>	<p>Page 10-102</p>

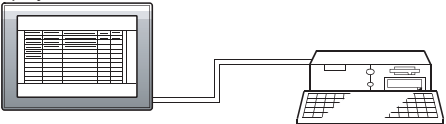


## 6 Trigger → action

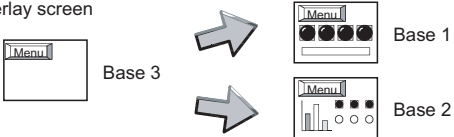

Image	Function	Page
<p>Status observation function</p>	<p>Monitors status of device and write value to device or operates GOT when condition meets</p>	<p>Page 11-1</p>
<p>Recipe function</p>	<p>Monitors status of device and write/read device data when condition meets</p>	<p>Page 11-12</p>
<p>Time action function</p>	<p>Outputs the device writing and sound at specified time.</p>	<p>Page 11-22</p>

## 7 External input/output

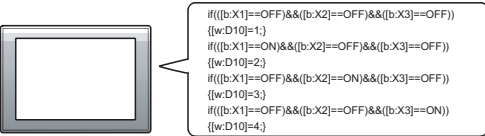
Image	Function	Page
<p>Report</p>	<p>Collects numerical data when condition meets and prints the numerical data and corresponding code.</p>	<p>Page 12-1</p>
<p>Hardcopy</p>	<p>Outputs the GOT monitor screen to printer or memory card</p>	<p>Page 12-25</p>
<p>Operation panel</p>	<p>Uses operation panel to execute device writing</p>	<p>Page 12-31</p>
<p>Bar code</p>	<p>Writes data read by barcode reader to device</p>	<p>Page 12-39</p>
<p>Sound</p>	<p>Outputs sounds</p>	<p>Page 12-46</p>
<p>Video</p>	<p>Displays video</p>	<p>Page 12-50</p>

Image	Function	Page
RGB display 	Displays PC screens	Page 12-68

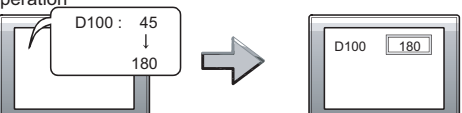
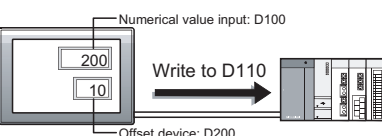

## 8 Others

Image	Function	Page
Set overlay screen 	Set overlay screen from other screens	Page 13-1
Test 	Changes device value via test window in monitor screen	Page 13-10


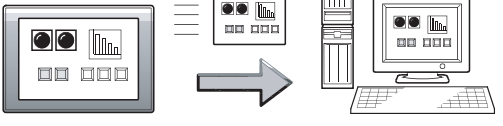
## 9 Script function

Image	Function	Page
Script  <pre> if((b:X1==OFF)&amp;&amp;(b:X2==OFF)&amp;&amp;(b:X3==OFF)) {w:D10=1;} if((b:X1==ON)&amp;&amp;(b:X2==OFF)&amp;&amp;(b:X3==OFF)) {w:D10=2;} if((b:X1==OFF)&amp;&amp;(b:X2==ON)&amp;&amp;(b:X3==OFF)) {w:D10=3;} if((b:X1==OFF)&amp;&amp;(b:X2==OFF)&amp;&amp;(b:X3==ON)) {w:D10=4;} </pre>	Controls GOT display by scripts	Page 14-1

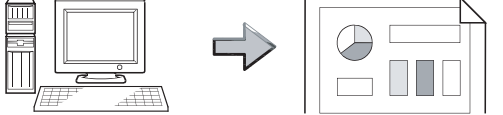
## 10 Object setting

Image	Function	Page
Data operation 	Operates device values by expression and enables objects using the operated value	Page 5-45
Offset 	Accumulates the offset device value in monitor device address and monitor	Page 5-52
Security 	Restricts the password users	Page 5-56

## Data Transmission (GT Designer2 Version□ Operating Manual)

Image	Function	Page
<p>Download</p> 	<p>Transmits monitor screen data from PC to GOT</p>	<p>Page 5-1</p>
<p>Upload</p> 	<p>Transmits monitor screen data from GOT to PC</p>	<p>Page 5-20</p>

## Print (GT Designer2 Version□ Operating Manual)

Image	Function	Page
<p>Print screen</p> 	<p>Print base/window/report screen</p>	<p>Page 6-1</p>

# Manuals

---

Relevant Manual

For relevant manual, refer to the PDF manual stored within the drawing software.

## ABBREVIATIONS AND GENERIC TERMS

Abbreviations and generic terms used in this manual are as follows:

### ■ GOT

Abbreviations and generic terms		Description	
	GT SoftGOT1000	Abbreviation of GT SoftGOT1000	
	GT1595	GT1595-X Abbreviation of GT1595-XTBA, GT1595-XTBD	
GOT1000 Series	GT1585	GT1585V-S Abbreviation of GT1585V-STBA, GT1585V-STBD	
		GT1585-S Abbreviation of GT1585-STBA, GT1585-STBD	
	GT157□	GT1575V-S Abbreviation of GT1575V-STBA, GT1575V-STBD	
		GT1575-S Abbreviation of GT1575-STBA, GT1575-STBD	
		GT1575-V Abbreviation of GT1575-VTBA, GT1575-VTBD	
		GT1575-VN Abbreviation of GT1575-VNBA, GT1575-VNBD	
	GT156□	GT1572-VN Abbreviation of GT1572-VNBA, GT1572-VNBD	
		GT1565-V Abbreviation of GT1565-VTBA, GT1565-VTBD	
	GT155□	GT1562-VN Abbreviation of GT1562-VNBA, GT1562-VNBD	
		GT1555-V Abbreviation of GT1555-VTBD	
	GT155□	GT1555-Q Abbreviation of GT1555-QTBD, GT1555-QSBD	
		GT1550-Q Abbreviation of GT1550-QLBD	
	GT15□□, GT15		Abbreviation of GT1595, GT1585, GT157□, GT156□, GT155□
	GT115□	GT1155-Q Abbreviation of GT1155-QTBDQ, GT1155-QSBDQ, GT1155-QTBDA, GT1155-QSBDA, GT1155-QTBD, GT1155-QSBD	
		GT1150-Q Abbreviation of GT1150-QLBDQ, GT1150-QLBDA, GT1150-QLBD	
	Handy GOT	GT1155HS-Q Abbreviation of GT1155HS-QSBD	
GT1150HS-Q Abbreviation of GT1150HS-QLBD			
GT11□□, GT11		Abbreviation of GT1155-Q, GT1150-Q, GT11 Handy GOT	
GT1030		Abbreviation of GT1030-LBD, GT1030-LBD2, GT1030-LBDW, GT1030-LBDW2	
GT1020		Abbreviation of GT1020-LBD, GT1020-LBD2, GT1020-LBL, GT1020-LBDW, GT1020-LBDW2, GT1020-LBLW	
GT10□□, GT10		Abbreviation of GT1030, GT1020	
GOT900 Series		Abbreviation of GOT-A900 series, GOT-F900 series	
GOT800 Series		Abbreviation of GOT-800 series	

### ■ Communication unit

Abbreviations and generic terms	Description
Bus connection unit	GT15-QBUS, GT15-QBUS2, GT15-ABUS, GT15-ABUS2, GT15-75QBUSL, GT15-75QBUS2L, GT15-75ABUSL, GT15-75ABUS2L
Serial communication unit	GT15-RS2-9P, GT15-RS4-9S, GT15-RS4-TE
RS-422 conversion unit	GT15-RS2T4-9P, GT15-RS2T4-25P
Ethernet communication unit	GT15-J71E71-100
MELSECNET/H communication unit	GT15-J71LP23-25, GT15-J71BR13
MELSECNET/10 communication unit	GT15-75J71LP23-Z <sup>*1</sup> , GT15-75J71BR13-Z <sup>*2</sup>
CC-Link IE controller network communication unit	GT15-J71GP23-SX
CC-Link communication unit	GT15-J61BT13, GT15-75J61BT13-Z <sup>*3</sup>
Interface converter unit	GT15-75IF900

\*1 A9GT-QJ71LP23 + GT15-75IF900 set

\*2 A9GT-QJ71BR13 + GT15-75IF900 set

\*3 A8GT-J61BT13 + GT15-75IF900 set

## ■ Option unit

Abbreviations and generic terms		Description
Printer unit		GT15-PRN
Video/RGB unit	Video input unit	GT15V-75V4
	RGB input unit	GT15V-75R1
	Video/RGB input unit	GT15V-75V4R1
	RGB output unit	GT15V-75ROUT
CF card unit		GT15-CFCD
CF card extension unit*1		GT15-CFEX-C08SET
External I/O unit		GT15-DIO
Sound output unit		GT15-SOUT

\*1 GT15-CFEX + GT15-CFEXIF + GT15-C08CF set.

## ■ Option

Abbreviations and generic terms		Description			
Memory card	CF card	GT05-MEM-16MC, GT05-MEM-128MC,	GT05-MEM-32MC, GT05-MEM-256MC	GT05-MEM-64MC,	
Memory card adaptor		GT05-MEM-ADPC			
Option function board		GT15-FNB, GT15-QFNB48M,	GT15-QFNB, GT15-MESB48M,	GT15-QFNB16M, GT11-50FNB	GT15-QFNB32M,
Battery		GT15-BAT,	GT11-50BAT		
Protective Sheet		GT15-90PSCB, GT15-80PSCB, GT15-70PSCB, GT15-60PSCB, GT15-50PSCB, GT11-50PSCB, GT11H-50PSC, GT10-30PSCB, GT10-20PSCB,	GT15-90PSGB, GT15-80PSGB, GT15-70PSGB, GT15-60PSGB, GT15-50PSGB, GT11-50PSGB, GT10-30PSGB, GT10-20PSGB,	GT15-90PSCW, GT15-80PSCW, GT15-70PSCW, GT15-60PSCW, GT15-50PSCW, GT11-50PSCW, GT10-30PSCW, GT10-20PSCW,	GT15-90PSGW, GT15-80PSGW, GT15-70PSGW, GT15-60PSGW, GT15-50PSGW, GT11-50PSGW, GT10-30PSGW, GT10-20PSGW,
Protective cover for oil		GT05-90PCO, GT05-50PCO	GT05-80PCO,	GT05-70PCO,	GT05-60PCO,
USB environmental protection cover		GT15-UCOV,	GT11-50UCOV		
Stand		GT15-90STAND, GT05-50STAND	GT15-80STAND,	GT15-70STAND,	A9GT-50STAND,
Attachment		GT15-70ATT-98, GT15-60ATT-87,	GT15-70ATT-87, GT15-60ATT-77,	GT15-60ATT-97, GT15-50ATT-95W,	GT15-60ATT-96, GT15-50ATT-85
Backlight		GT15-90XLTT, GT15-70VLTN,	GT15-80SLTT, GT15-60VLTT,	GT15-70SLTT, GT15-60VLTN	GT15-70VLTT,
Multi-color display board		GT15-XHNB,	GT15-VHNB		
Connector conversion box		GT11H-CNB-37S			
Emergency stop sw guard cover		GT11H-50ESCOV			
Memory loader		GT10-LDR			

## ■ Software

Abbreviations and generic terms	Description
GT Works2 Version□	SW□D5C-GTWK2-E, SW□D5C-GTWK2-EV
GT Designer2 Version□	SW□D5C-GTD2-E, SW□D5C-GTD2-EV
GT Designer2	Abbreviation of screen drawing software GT Designer2 for GOT1000/GOT900 series
GT Converter2	Abbreviation of data conversion software GT Converter2 for GOT1000/GOT900 series
GT Simulator2	Abbreviation of screen simulator GT Simulator 2 for GOT1000 / GOT900 series
GT SoftGOT1000	Abbreviation of monitoring software GT SoftGOT1000
GT SoftGOT2	Abbreviation of monitoring software GT SoftGOT2
GX Developer	Abbreviation of SW□D5C-GPPW-E(-EV)/SW□D5F-GPPW-E type software package
GX Simulator	Abbreviation of SW□D5C-LLT-E(-EV) type ladder logic test tool function software packages (SW5D5C-LLT (-EV) or later versions)
Document Converter	Abbreviation of document data conversion software Document Converter for GOT1000 series
PX Developer	Abbreviation of SW□D5C-FBDQ-E type FBD software package for process control

## ■ License key (for GT SoftGOT1000)

Abbreviations and generic terms	Description
License	GT15-SGTKEY-U, GT15-SGTKEY-P

## ■ License key (for GT SoftGOT2)

Abbreviations and generic terms	Description
License key	A9GTSOFT-LKEY-P (For DOS/ PC)
License key FD	SW5D5F-SGLKEY-J (For PC CPU module)

■ Others

Abbreviations and generic terms		Description
OMRON PLC		Abbreviation of PLC manufactured by OMRON Corporation
KEYENCE PLC		Abbreviation of PLC manufactured by KEYENCE CORPORATION
KOYO EI PLC		Abbreviation of PLC manufactured by KOYO ELECTRONICS INDUSTRIES CO., LTD.
SHARP PLC		Abbreviation of PLC manufactured by Sharp Corporation
JTEKT PLC		Abbreviation of PLC manufactured by JTEKT Corporation
TOSHIBA PLC		Abbreviation of PLC manufactured by TOSHIBA CORPORATION
TOSHIBA MACHINE PLC		Abbreviation of PLC manufactured by TOSHIBA MACHINE CO., LTD.
HITACHI IES PLC		Abbreviation of PLC manufactured by Hitachi Industrial Equipment Systems Co., Ltd.
HITACHI PLC		Abbreviation of PLC manufactured by Hitachi, Ltd.
FUJI FA PLC		Abbreviation of PLC manufactured by Fuji Electric FA Components & Systems Co., Ltd.
MATSUSHITA PLC		Abbreviation of PLC manufactured by Matsushita Electric Works, Ltd.
YASKAWA PLC		Abbreviation of PLC manufactured by YASKAWA Electric Corporation
YOKOGAWA PLC		Abbreviation of PLC manufactured by Yokogawa Electric Corporation
ALLEN-BRADLEY PLC		Abbreviation of Allen-Bradley PLC manufactured by Rockwell Automation, Inc.
GE FANUC PLC		Abbreviation of PLC manufactured by GE Fanuc Automation Corporation
SCHNEIDER PLC		Abbreviation of PLC manufactured by Schneider Electric SA
SIEMENS PLC		Abbreviation of PLC manufactured by Siemens AG
Temperature controller	OMRON temperature controller	Abbreviation of temperature controller manufactured by OMRON Corporation
	SHINKO indicating controller	Abbreviation of temperature controller manufactured by Shinko Technos Co., Ltd.
	CHINO controller	Abbreviation of temperature controller manufactured by CHINO CORPORATION
	FUJI SYS temperature controller	Abbreviation of temperature controller manufactured by Fuji Electric Systems Co., Ltd.
	YAMATAKE temperature controller	Abbreviation of temperature controller manufactured by Yamatake Corporation
	YOKOGAWA temperature controller	Abbreviation of temperature controller manufactured by Yokogawa Electric Corporation
	RKC temperature controller	Abbreviation of temperature controller manufactured by RKC INSTRUMENT INC.
PC CPU module		Abbreviation of PC CPU Unit manufactured by CONTEC CO., LTD
GOT (server)		Abbreviation of GOTs that use the server function
GOT (client)		Abbreviation of GOTs that use the client function
Windows <sup>®</sup> font		Abbreviation of TrueType font and OpenType font available for Windows <sup>®</sup> (Differs from the True Type fonts settable with GT Designer2)
Intelligent function module		Indicates the modules other than the PLC CPU, power supply module and I/O module that are mounted to the base unit.
MODBUS <sup>®</sup> /TCP		Generic term for the protocol designed to use MODBUS <sup>®</sup> protocol messages on a TCP/IP network.



# How to Use This Manual

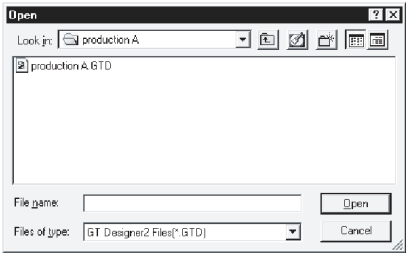
## Specification of symbols used in this manual

**4.3 Opening/Closing Project**

**4.3.1 Opening project**

A saved project data is read from the project save source.

- Perform either of the following operations.
  - Click (Open).
  - Select [Project] → [Open] menu.
- The open dialog box is displayed.



Item	Description	A	F
Look in	Select the location where the project is saved.	○	○
File name	Set the project name for opening.	○	○
Files of type	Select the type of project for opening. GTD file (★.GTD) : Project data of GT Designer2 is opened. DU-Win file (★.DUP) : Project data of DU-Win is opened. GOT file (★.GOT) : Project data of GT Designer is opened.	○	○

**Remark** (1) Using existing GOT data

- GOT800 series : The data is converted to the monitor screen data for the GOT-A900 series with the GT converter.
- A77GOT and 64GOT : The data is converted to the monitor data for the GOT-A800 series and this data is converted to the monitor screen data for the GOT-A900 series with the GT converter.

Refer to the following for conversion to the monitor screen data for the GOT-A900 series.

GT Converter Help function

(2) Using existing DU (data access unit) data

- DU series: Select the DU-WIN file and open the project data.  
The DU-WIN file is the project data prepared with the FX-PCS-DU/WIN drawing software.

4 - 3 4 - 3

**1** → **2** → **3** . . . . .

Indicates the operation steps.

Brackets used for the menu and items differ.

[ ] : Refers to menu in menu bar.

Refers to dialog box item or GOT utility menu.

: Refers to dialog box buttons or PC keyboard.

Shows functions applicable to GOT-A900 series (GOT-A900) GOT-F900 series (GOT-F900).

"○", Applicable

"×", N / A

**Point!**

Refers to information required for operation.



**Hint!**

Refers to information useful for operation.



**Remark**

Refers to supplementary explanations.

Shows the items including detailed explanation (manual and the chapter, section, item).

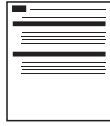
# Product List

---

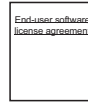
The following shows the product list of GT Works2 or GT Designer2.



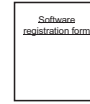
SW1D5C-GTWK2-E  
or  
SW1D5C-GTD2-E



About installation method of GT  
Works2/GT Designer2



End-user software  
license agreement



Software  
registration form



License agreement

## NOTICES

- We don't guarantee the commercially-available Microsoft Windows Operating System-based software products that have been introduced in this manual.
- We hold the copyrights of this software package.
- No part of this manual may be transcribed or duplicated in any form without prior permission by Mitsubishi Electric Corporation.
- We have attempted to cover all the revisions of software and hardware, but this manual may not contain the latest revisions.
- The software of this product requires one license to be purchased per computer.
- We permit the user to use this software package (including this manual) based on the Software License Agreement.
- We are not liable for consequences or influences due to this software package (including this manual).
- The specifications of this software package and the descriptions in this manual may be altered in future without prior notice.

# 1. OVERVIEW

## 1.1 Overview

















This manual explains the GT Designer2 system configuration, GT Designer2 screen configuration, basic dialog box operation, creation of new project, data transfer to GOT and convenient operation for screen editing.

### 1 Manuals

Three types of manuals are available for GT Designer2.

Refer to the appropriate manual depending on the purpose.

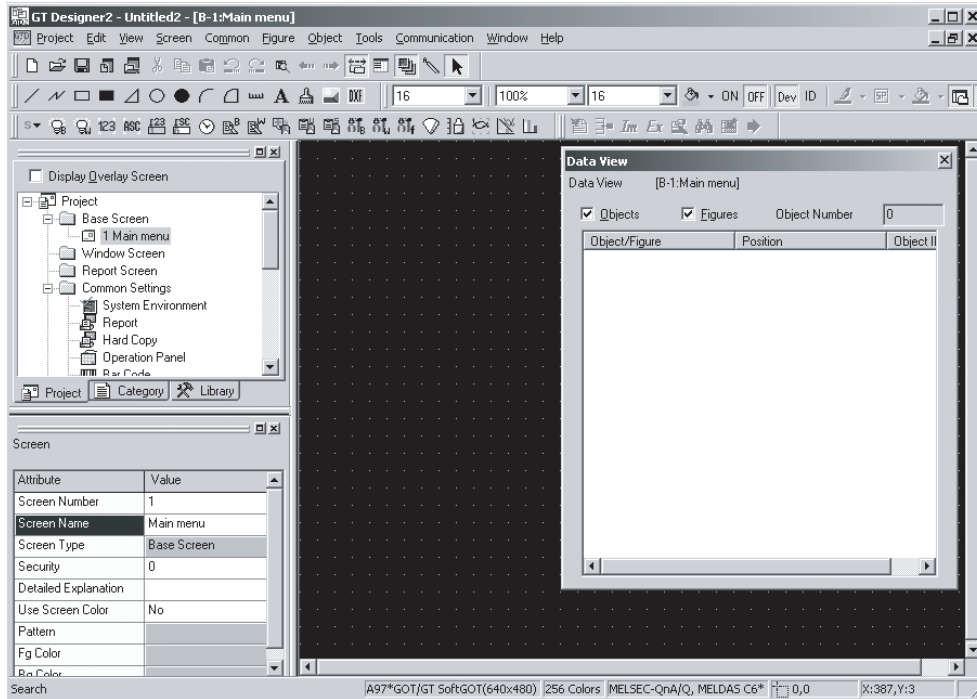
The manuals below are stored in PDF files and included with the product.

			
Purpose	Startup • Introductory Manual	Reference Manual	Operating Manual
Install the product into the personal computer			
Create a project			
Create screens			
Draw figures			
Make common settings			
Arrange/set objects			
Transfer data to the GOT			

- (1) Startup & Introductory manual  
The product installation method is described.  
Examples of simple screen creation and operation on the GOT are described.
- (2) Reference Manual  
Object/figure/screen specifications and object setting methods are described.
- (3) Operating Manual  
Screen configuration, screen customizing, and procedures from project creation to data transfer on the GT Designer2 are described.

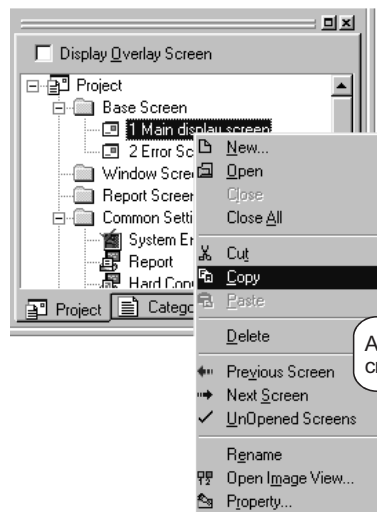
## 1.2 Feature

The GT Designer2 has various functions to improve the drawing efficiency. Main functions of the GT Designer2 are described below:



### 1.2.1 Easy-to-use operations

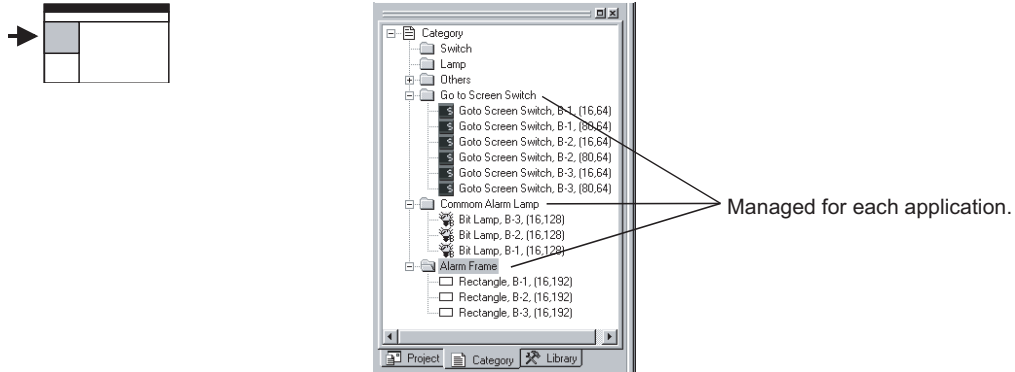
- 1 Easy to know the overall project (→ Section 3.1.2 Operation of workspace)  
Settings of the overall project such as created screens or common settings are displayed on the tree. It is convenient to know the current settings, to check progress of work and to copy the screen.



A screen can be newly created, copied or deleted.

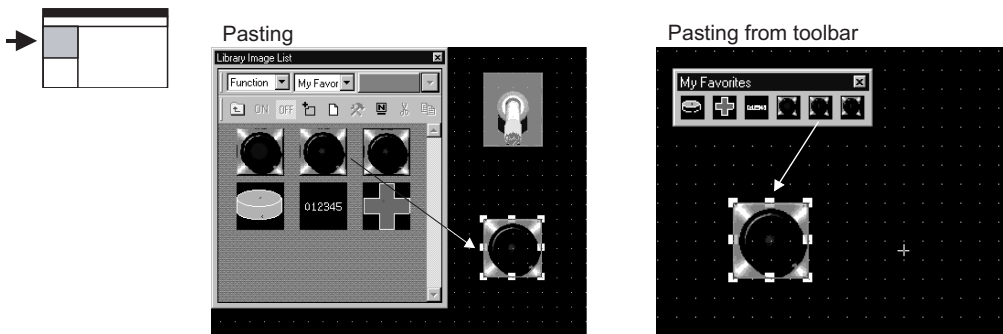
**2** Easy to manage objects for each application (👉 Section 9.1.2 Batch setting and managing objects/figures for each purpose (Category workspace))

The overall project settings are displayed on the tree by category (type).  
Classification for each application allows simple management of objects.



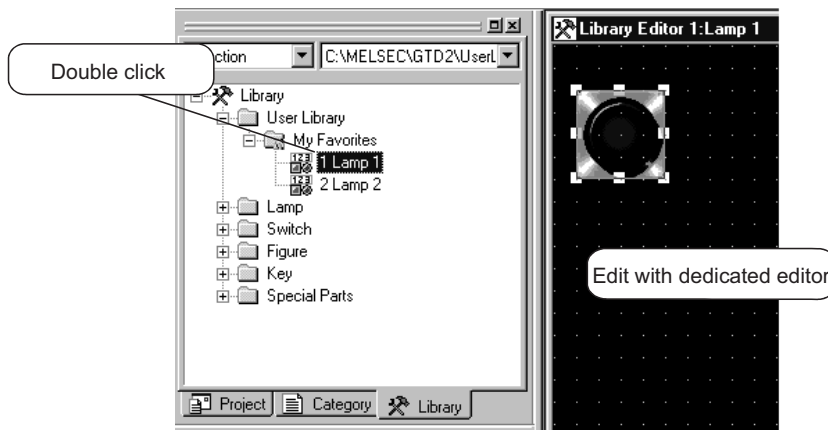
**3** Easy to select parts frequently used (👉 Chapter 7 USING LIBRARY)

Objects or figures can be registered and pasted on the screen.  
Objects or figures frequently used may be registered as buttons on the toolbar.



Simple edit of parts

Part objects or figures once registered can be re-edited with the dedicated editor (library editor).

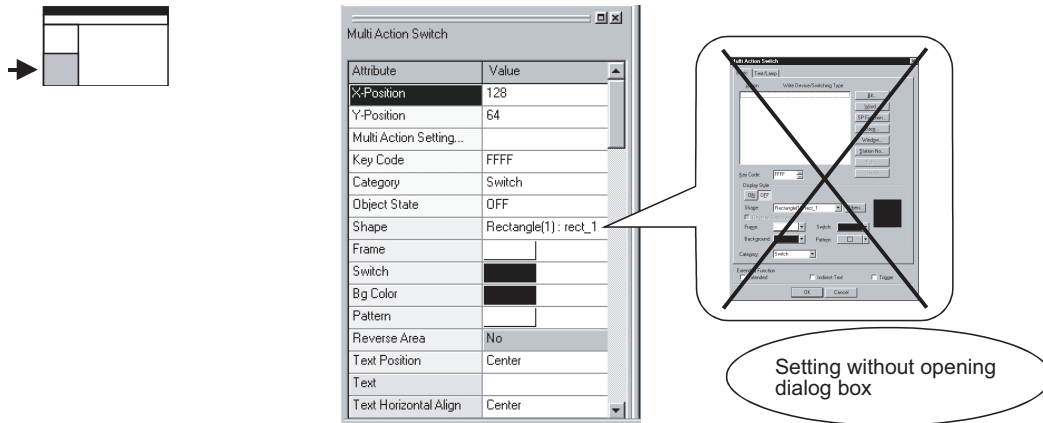


## 1.2.2 Useful functions

### 1 Shortest setting without opening dialog box (☞ Section 9.1.1 Batch setting of multiple objects/figures on the same screen (Property sheet))

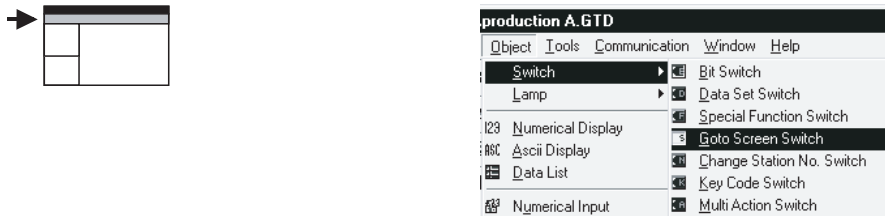
All setting items and setting details being currently selected are displayed in a list.

Objects and figures can be set without opening the dialog box and the setting details can be checked.



### 2 Classifying objects for each application

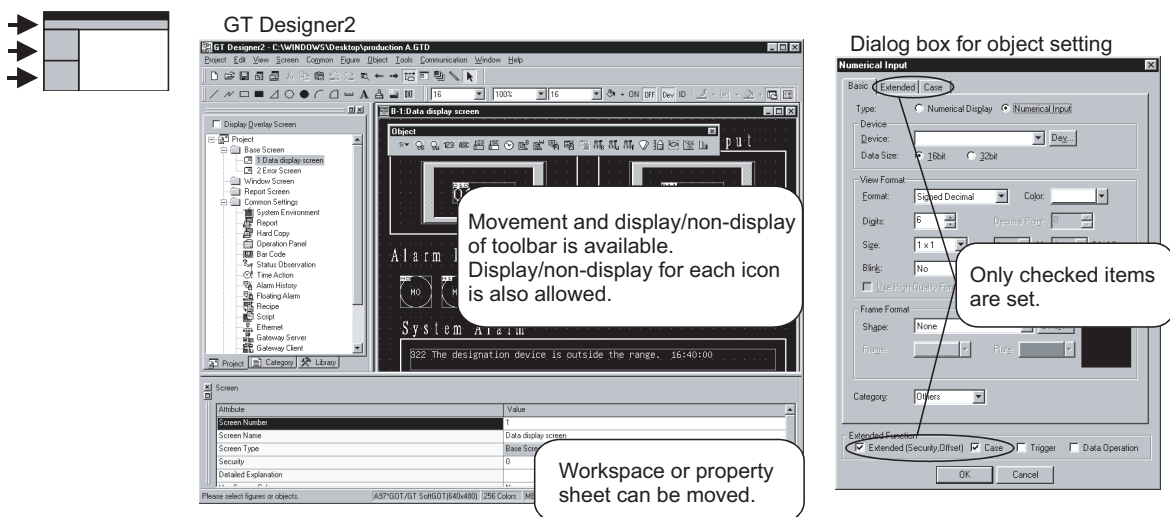
Since the touch switches are classified for each application, the desired touch switch for setting can be simply selected. The lamp display function and the part display function are classified into the bit device and the word device. In this way, the number of setting items is reduced.



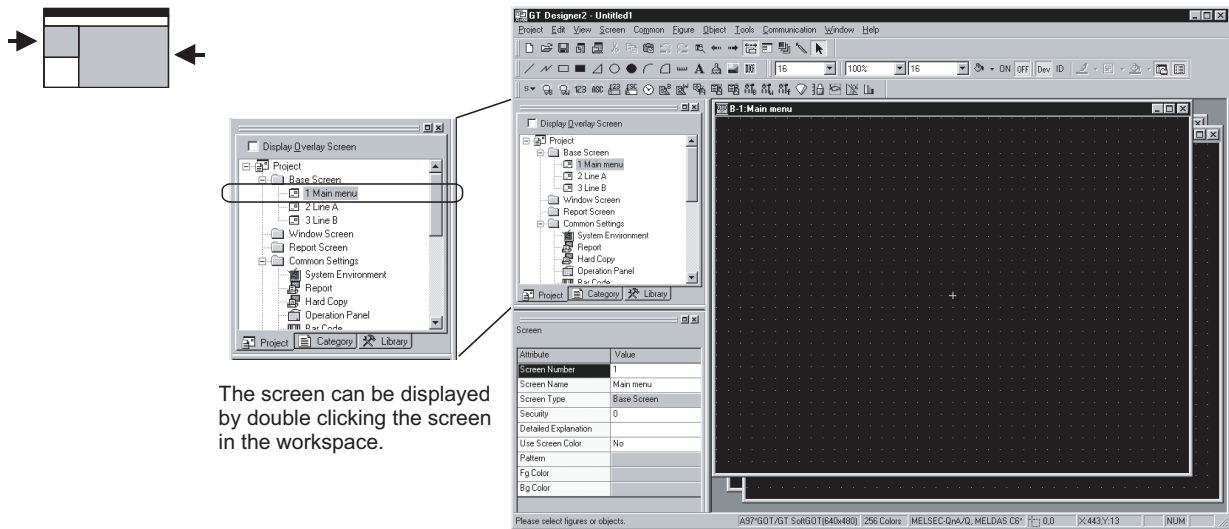
### 3 Customizing screen (☞ Section 3.4.1 Customizing screen configuration)

The screen can be customized for the workspace, movement of property sheet or toolbars display/non-display. You may create figures in the preferred environment.

The dialog box for setting objects may also be customized.

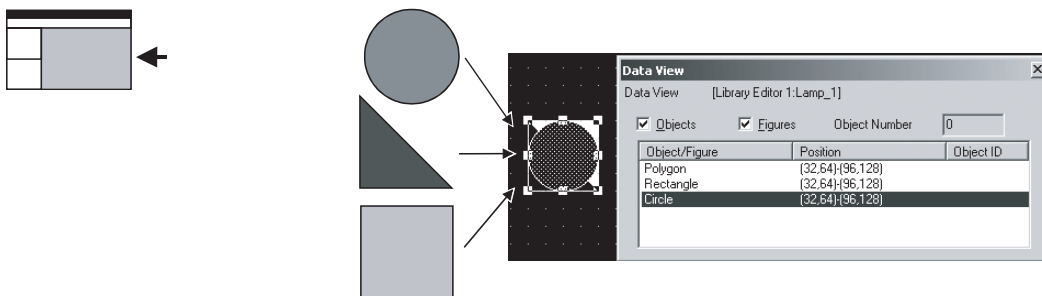


- 4 Quick selection of desired screen for editing (☞ Section 4.6.1 Opening screen)**  
 Double click the screen in the project workspace to display the desired screen for editing.



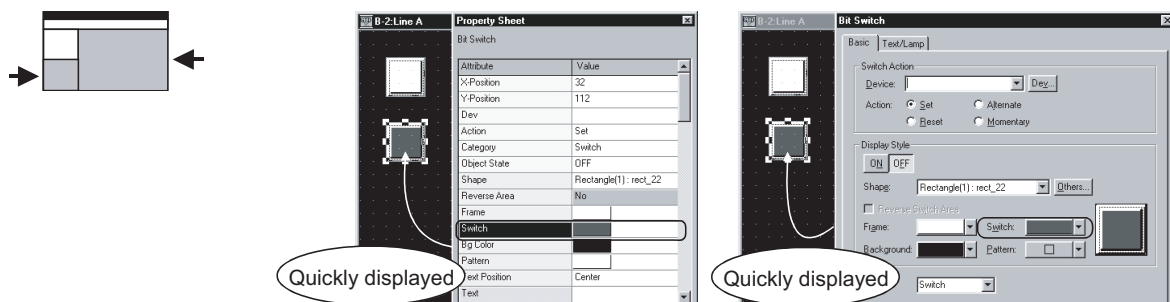
- 5 Quick selection of desired part for editing (☞ Section 9.1.4 Simple selection of overlapped figure (Data view))**

Objects or figures set on the screen can be displayed in a list.  
 If multiple objects or figures are overlapped, it can be simply selected from the Data View.  
 Currently selected objects or figures can also be checked.



- 6 Real time check of settings in graphic display (view direct)**

Setting on the property sheet or the dialog box is quickly displayed on the screen.  
 Since the screen display can be checked, a screen as you wish can be smoothly created.

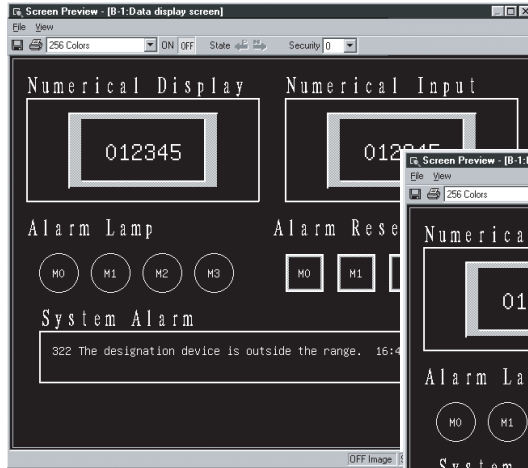




## 7 Confirming the screen display on the GOT (Preview) (☞ Section 4.10 Viewing Created Screen Image)

The screen display on the GOT can be confirmed on GT Designer2.

Also, the windowed screen can be confirmed.



Base Screen Preview



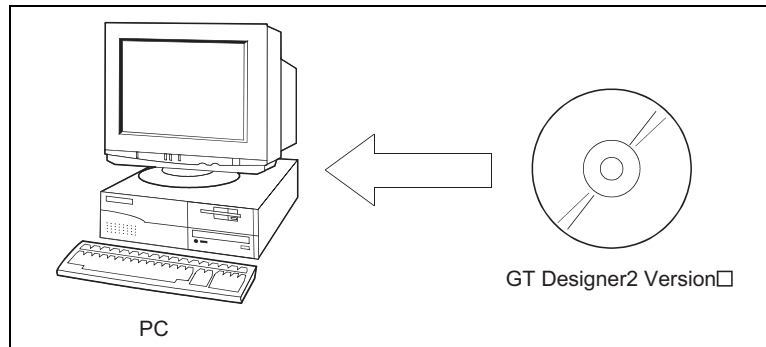
Windowed Screen Preview

# 2. SYSTEM CONFIGURATION

## 2.1 System Configuration in Creating Monitor Screen

### 2.1.1 System configuration

The system configuration of GT Designer2 is shown below:



### 2.1.2 Operating environment

The operating environment of GT Designer2 is shown below:

Item	Description
Personal computer	PC/AT compatible personal computer that Windows® runs on
Operating system	Microsoft® Windows® 98 Operating System (English, Simplified Chinese, Traditional Chinese, Korean, German versions) Microsoft® Windows® Millennium Edition Operating System (English, Simplified Chinese, Traditional Chinese, Korean, German versions) Microsoft® Windows NT® Workstation 4.0 Operating System Service Pack 3 or later (English, Simplified Chinese, Traditional Chinese, Korean, German versions)*1 Microsoft® Windows® 2000 Professional Operating System Service Pack 4 or later (English, Simplified Chinese, Traditional Chinese, Korean, German versions)*1 Microsoft® Windows® XP Professional Operating System Service Pack 2 or later (English, Simplified Chinese, Traditional Chinese, Korean, German versions)*2 *4 *5 Microsoft® Windows® XP Home Edition Operating System Service Pack 2 or later (English, Simplified Chinese, Traditional Chinese, Korean, German versions)*2 *4 *5 Microsoft® Windows Vista® Ultimate Operating System (English, Simplified Chinese, Traditional Chinese, Korean, German versions)*3 *4 *5 Microsoft® Windows Vista® Enterprise Operating System (English, Simplified Chinese, Traditional Chinese, Korean, German versions)*3 *4 *5 Microsoft® Windows Vista® Business Operating System (English, Simplified Chinese, Traditional Chinese, Korean, German versions)*3 *4 *5 Microsoft® Windows Vista® Home Premium Operating System (English, Simplified Chinese, Traditional Chinese, Korean, German versions)*3 *4 *5 Microsoft® Windows Vista® Home Basic Operating System (English, Simplified Chinese, Traditional Chinese, Korean, German versions)*3 *4 *5
Computer	
CPU	Refer to "Applicable operating system and performance required for personal computer" on the next page.
Memory	
Hard disk space	For installation: 1.1GB or more*7 For execution: 100MB or more
Disk drive	CD-ROM drive
Display color	High Color (16 bits) or more
Display*6	Resolution 800 × 600 dots or more



## 2.2 System Configuration of Data Transfer and Document Creation

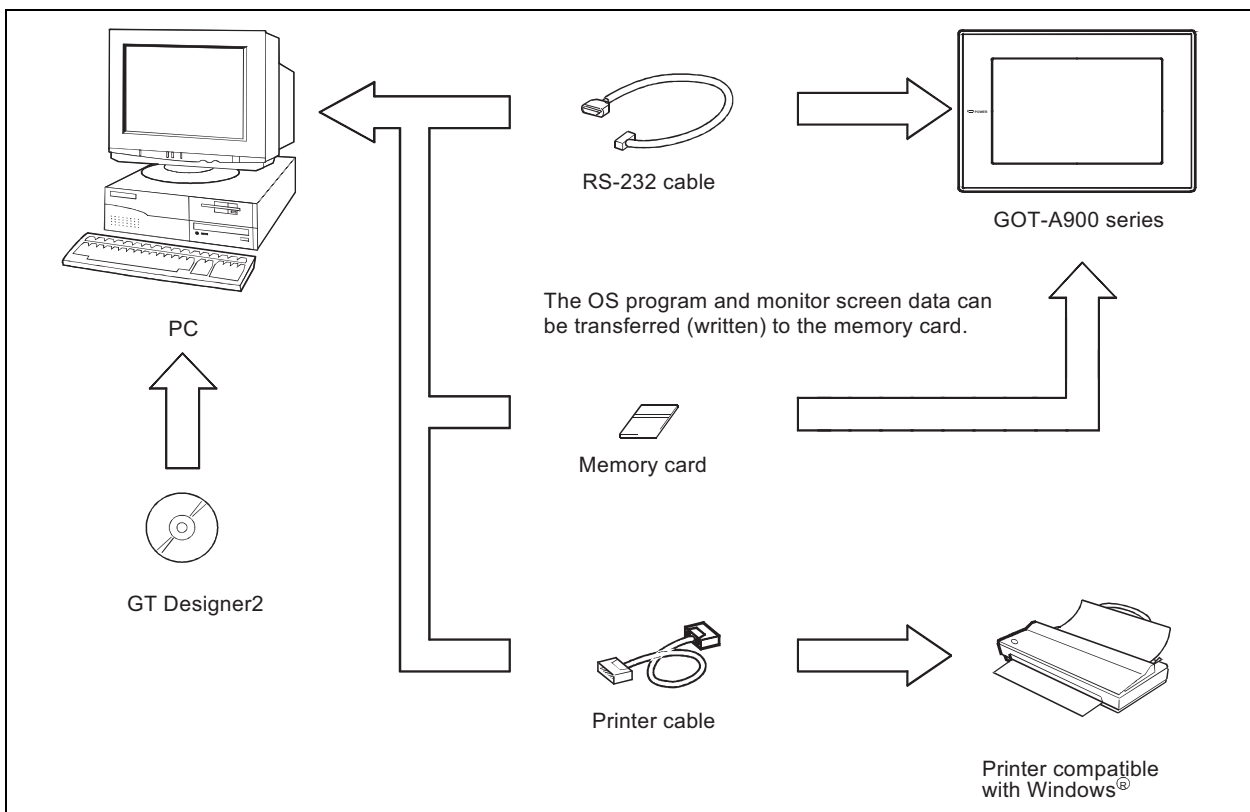
### 2.2.1 System configuration

#### 1 Using GOT-A900 series

The system configuration using the GOT-A900 series is shown below.

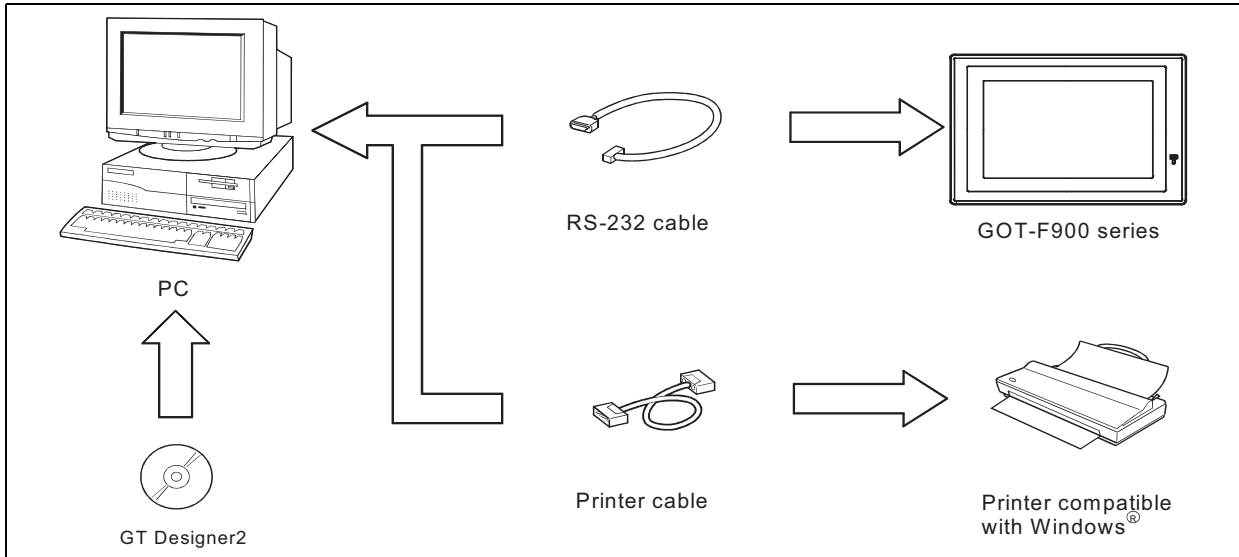
Refer to Section 2.2.2 for the RS-232 cable.

Refer to the GOT user's manual (Details) for the memory card.



## 2 Using GOT-F900 series

The system configuration using the GOT-F900 series is shown below.  
Refer to Section 2.2.2 for the RS-232 cable.



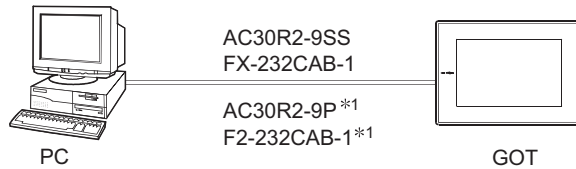
## 2.2.2 RS-232 cable to be used

The cable type for connection between the PC and the GOT and the connection diagram are shown below.

### 1 Using GOT-A900 series

The cable shown below or in the connection diagram is required.

#### (1) System configuration



\*1 9-25 pin converter (Diatrend Corp. D232J31) is required.

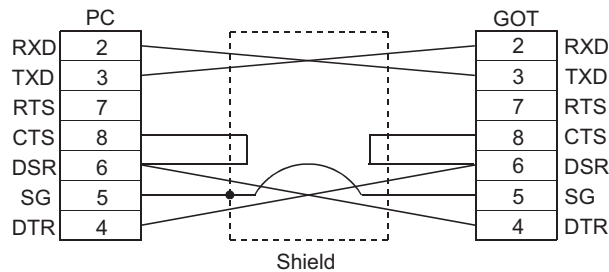
#### (2) Cable for use

Cable	Manufacturer
AC30R2-9SS (9 pin - 9 pin) FX-232CAB-1 (9 pin - 9 pin)	Mitsubishi Electric Corporation
AC30R2-9P (9 pin - 25 pin) F2-232CAB-1 (9 pin - 25 pin)	

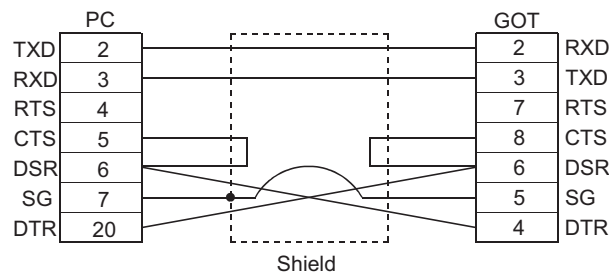
#### (3) Connection diagram

Use the screw-in type (inch screw) connector for the GOT.

##### (a) Connection diagram for cables equivalent to AC30R2-9SS and FX-232CAB-1



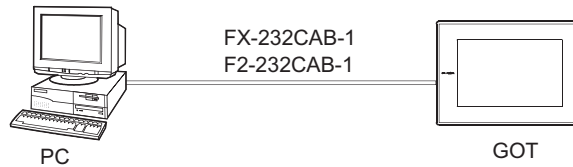
##### (b) Connection diagram for cables equivalent to AC30R2-9P and F2-232CAB-1



## 2 Using GOT-F900 series

The cable shown below or in the connection diagram is required.

### (1) System configuration



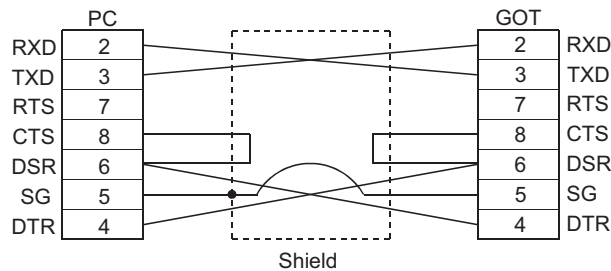
### (2) Cable for use

Cable	Manufacturer
AC30R2-9SS (9 pin - 9 pin) FX-232CAB-1 (9 pin - 9 pin)	Mitsubishi Electric Corporation

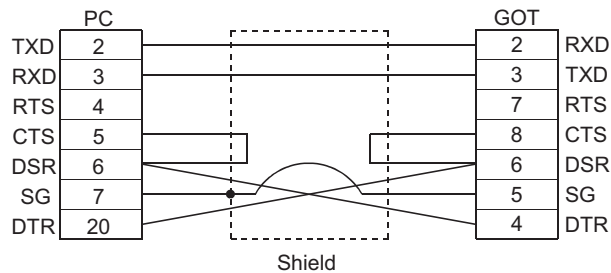
### (3) Connection diagram

Use the screw-in type (inch screw) connector for the GOT.

#### (a) Connection diagram for cables equivalent to FX-232CAB-1.



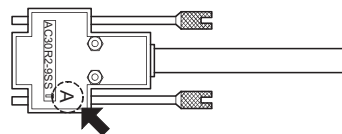
#### (b) Connection diagram for cables equivalent to F2-232CAB-1.



#### (1) Cable to be used

The cable for the Version A or later cannot be used.

The RS-232 cable for the Version A or later has the version name at the upper right of the model on the connector. Check the version.



#### (2) Cable to be created

Use the F2-232CAB-1 connection cable when the PLC CPU and the GOT are used at the same time with FX-2PIF by connecting the F940GOT or the F930GOT to the A series CPU or the FX series CPU through the RS-422 cable.

# 3. SCREEN CONFIGURATION OF GT DESIGNER 2

## 3.1 Screen Configuration and Basic Operation

### 3.1.1 Screen configuration and various tools

#### 1 Screen configuration and various tools

The screen configuration and various tools are described.

The screenshot shows the GT Designer 2 interface with the following components labeled:

- Title bar:** Located at the top of the window.
- Menu bar:** Located below the title bar, containing Project, Edit, View, Screen, Common, Figure, Object, Tools, Communication, Window, and Help.
- Toolbars:** Located below the menu bar, containing various icons for screen creation and editing.
- Display Overlay Screen:** A tree view on the left showing the project structure, including Base Screen, Production Output Screen, Message Display, Data Display Screen, Error Cause Confirmation Screen, Multilingual Input, Main Menu, Window Screen, Repeat Screen, Common Settings, and Comment.
- Workspace:** The central area where the screen is configured, showing a 'Data Indicator panel' and a 'Data Input' panel.
- Property sheet:** A panel at the bottom left showing attributes for the selected screen, such as Screen Number, Screen Name, Screen Type, Security, Detailed Explanation, Use Screen Color, Pattern, Fg Color, Bg Color, and Transparent Color.
- Library Image list:** A panel at the bottom center showing a collection of graphical elements like buttons and indicators.
- Part Image list:** A panel at the bottom right showing a collection of parts used in the part display function.
- Data View:** A panel on the right showing a list of objects and figures on the screen, including Text, Rectangle, and Numerical Display.
- Status bar:** Located at the bottom of the window, showing the current screen name and other details.

Additional descriptions and references:

- Created screen:** All object functions and its number and figures arranged on the screen are displayed in a list. (Section 9.1.5)
- Settings on the overall project:** Settings on the overall project such as created screen and common settings are displayed in tree. (Section 3.1.2)
- Attributes of selected screen:** Attributes of selected screen, objects and figures are displayed. Settings can be made here. (Section 9.1.1)
- Library is displayed:** Library is displayed. Objects/figures in library can be pasted. (Chapter 7)
- Parts used in the part display function:** Parts used in the part display function are displayed. (GT Designer2 Version Reference Manual)



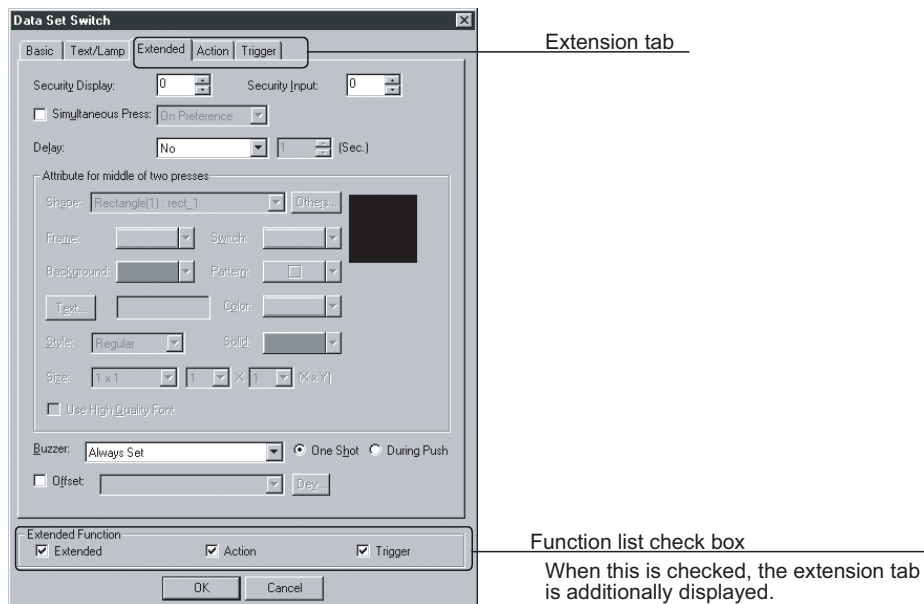
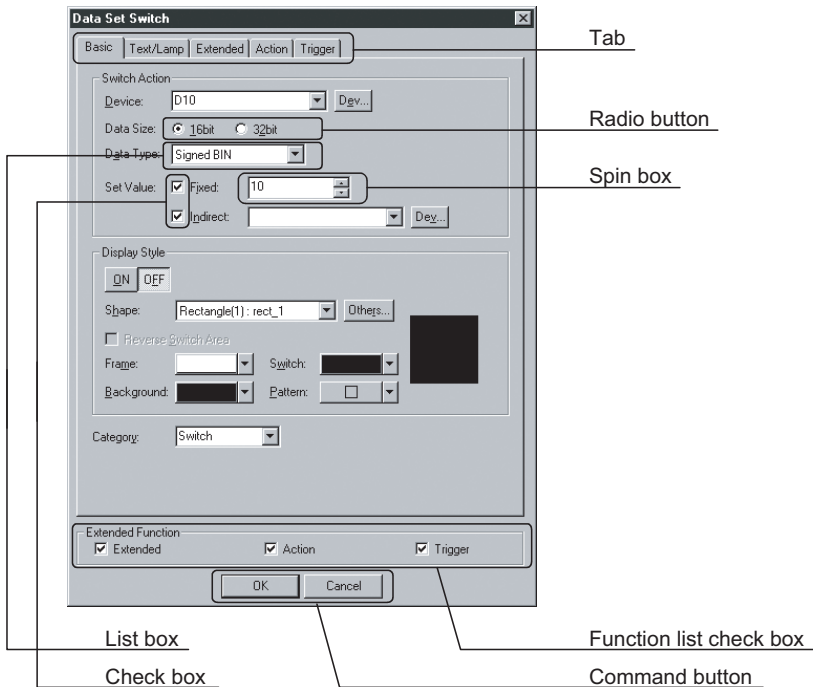
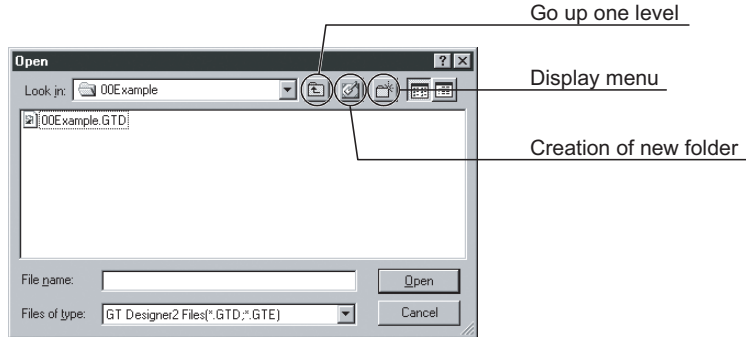
Dropdown menu

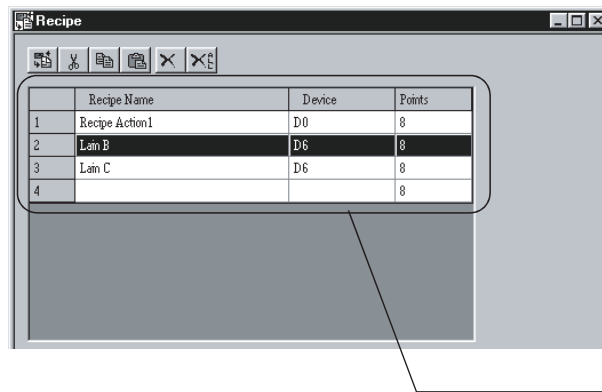
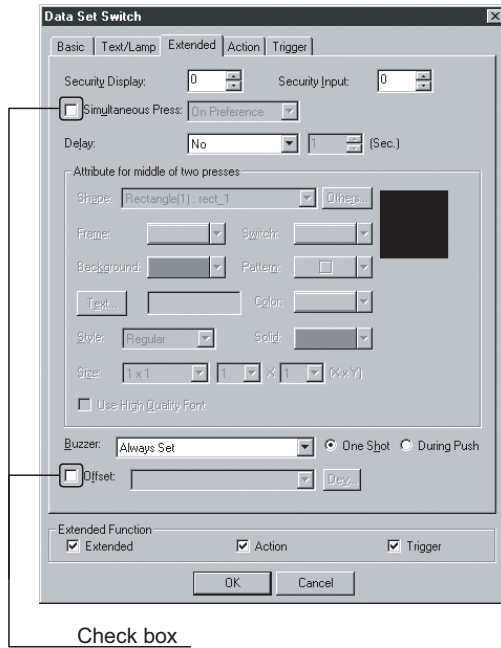


## 2 Dialog box

Refer to the following section for the operation method.

☞ Section 4.7.5 Basic operations of dialog box





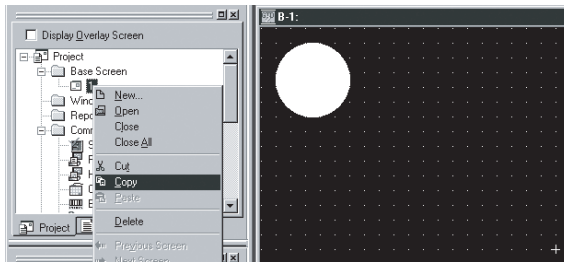
## 3.1.2 Operation of workspace

### 1 Workspace

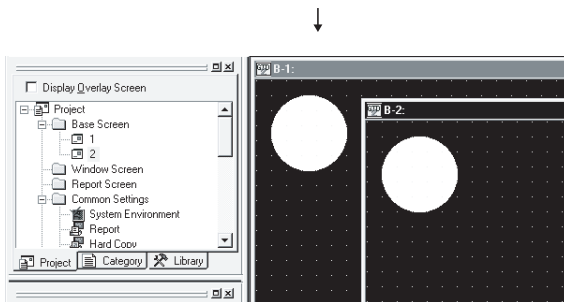
The overall project settings are displayed in a tree by data type. It is easy to manage and edit the overall project data.

#### Ex. 1) Screen copy

The existing screen is copied using the workspace.



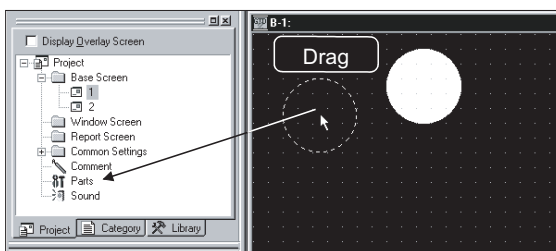
Select the copy source screen and right click on the mouse to select the [Copy] menu.



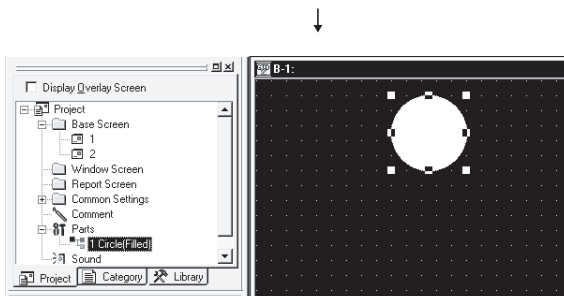
Right click the mouse again to select the [Paste] menu. When the screen property is set, the screen is copied.

#### Ex. 2) Part registration

A figure is registered as a part using the workspace.



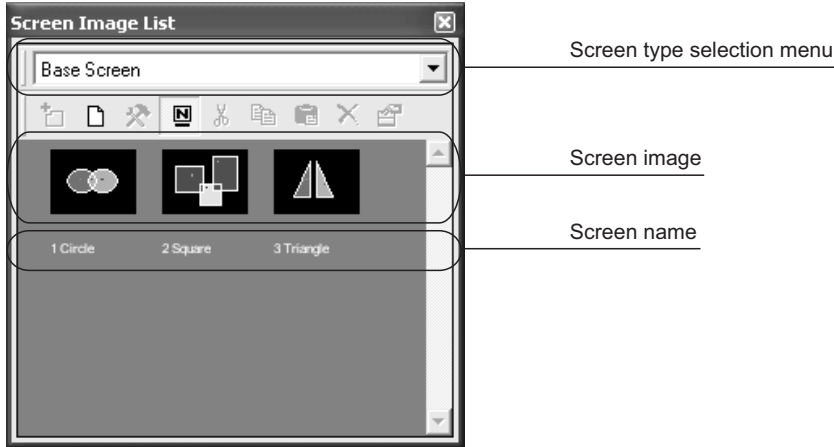
Select the figure for registration and drag it to the Parts folder in the workspace.












When the part number and name are set, the figure is registered as a part.

## 2 Basic operations of Screen Image List Window

In the project workspace, Screen Image List Window is displayed when [Open Image View...] is selected after right-clicking Base Screen or Window Screen. In the Screen Image List, an image from Base Screen, Window Screen, or an image of set overlay screen (Base Screen/Window Screen) can be displayed, and screen can be created or edited.



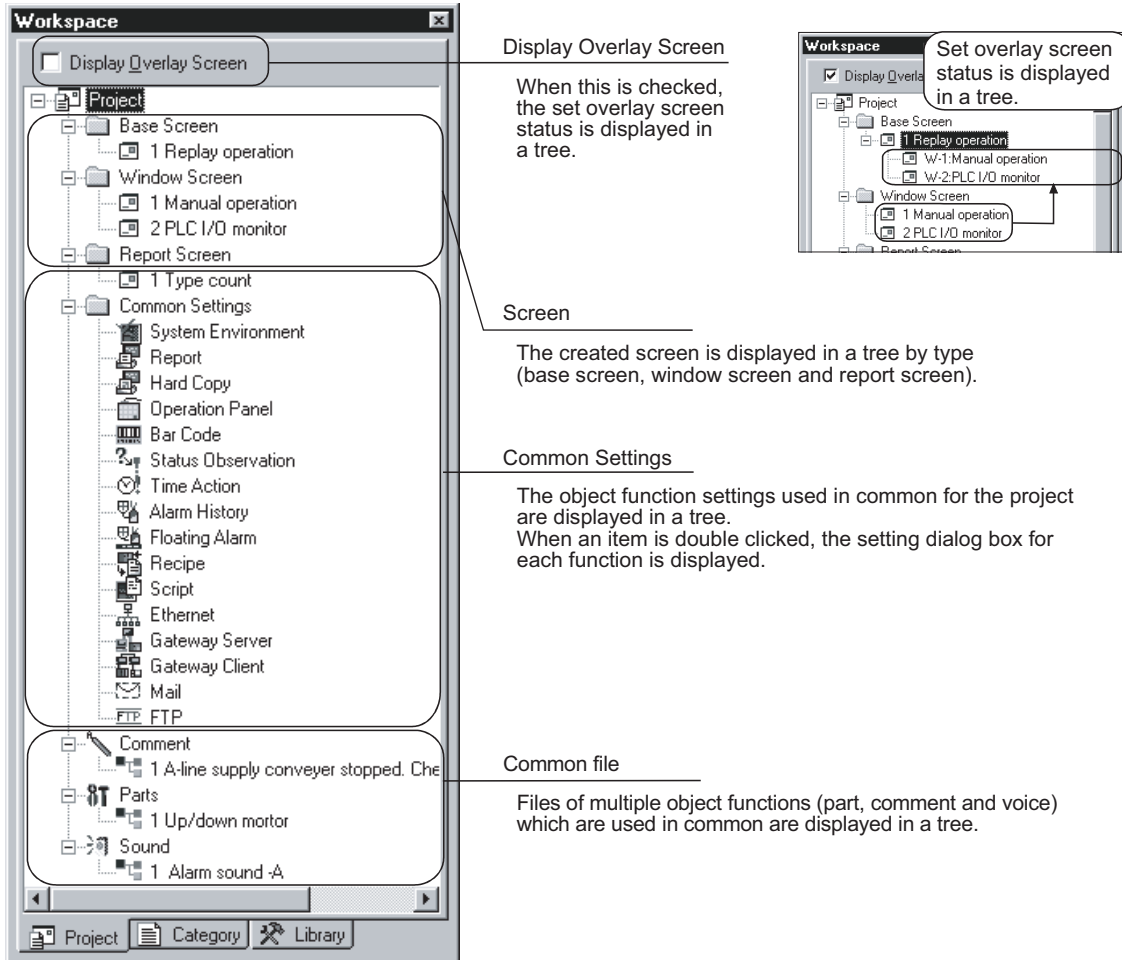
Item	Contents
Screen type selection menu	Screen type is switched.
 (Register)	Figures and objects that are selected with screen editor are placed on the created screen.
 (New)	New screen is created.
 (Edit)	Registered screen details are edited with screen editor.
 (Name)	Display/non-display of the screen name is selected.
 (Cut)	Selected screen is cut.
 (Copy)	Selected screen is copied.
 (Paste)	Copied screen, cut screen are pasted on the screen with the press of each <code>[Copy]</code> , <code>[Cut]</code> button.
 (Delete)	Selected screen is deleted.
 (Property)	Property of the screen is displayed.

### 3 Workspace type

Types of the workspace are described here.

#### ■ Project workspace

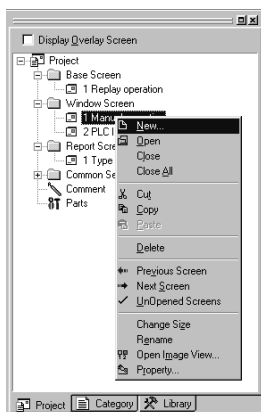
Overall project settings such as created screens and common settings are displayed in a tree. It is convenient to see the project details, to check the work progress and to copy a screen.



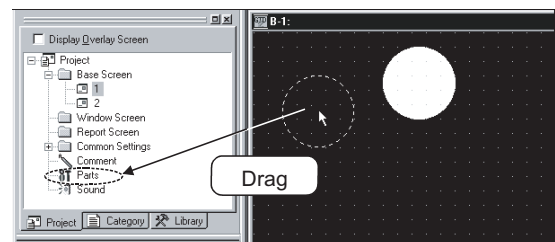
#### Available functions

- Right click the mouse to select basic commands such as New Screen, Open or Copy.
- Dragging a figure to the Project workspace allows registration of a Parts.

Ex.) Right click the window screen.



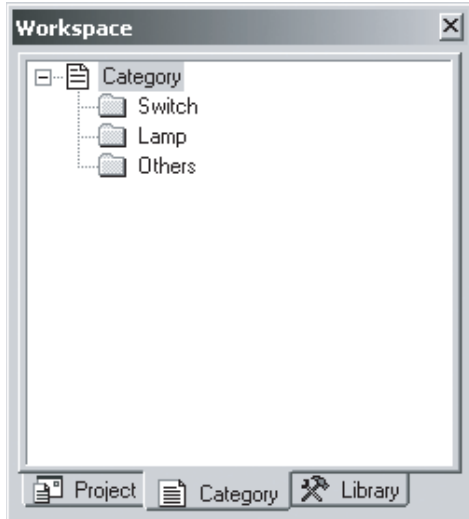
Ex.) Drag a figure.



■ Category workspace

The overall project setting is displayed in a tree by Category (type).  
Classification for each application simplifies management and editing of objects.

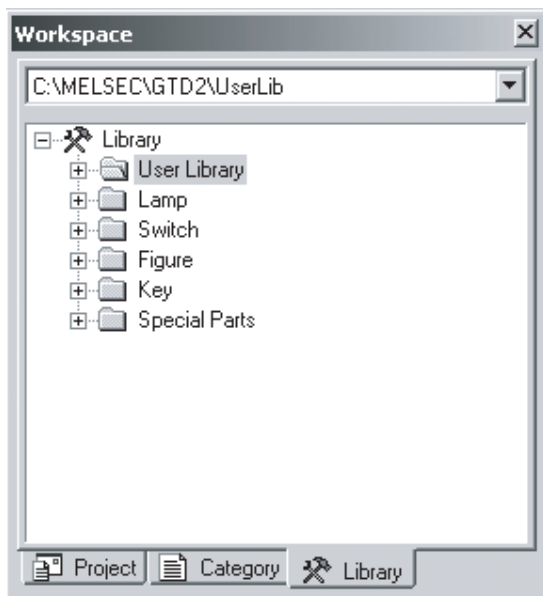
☞ Section 9.1.2 Batch setting and managing objects/figures for each purpose (Category workspace)



■ Library workspace

Objects or figures can be registered and pasted to the screen.

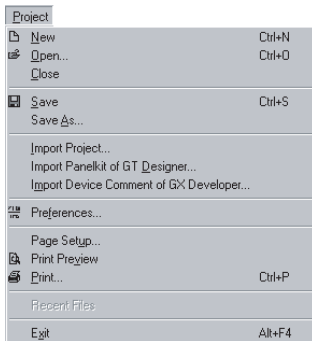
☞ Chapter 7 USING LIBRARY



## 3.2 Menu Configuration

Commands assigned to the menu bar are described.

### Project



The Project menu contains functions of file management, preference settings and printing.

New creation of project, reading existing files, preference settings and printing of data being edited are available.

The recent file record can also be displayed.

### Edit



The Edit menu contains edit functions for created figures/objects.

If incorrect operation is done during edit, the screen can be returned to the previous status. Copy, paste and grouping of objects and figures are also allowed.

 Chapter 8 DRAW AND EDIT

### View

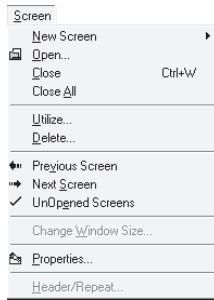


The View menu contains functions of display on the GT Designer2.

Toolbars, status bar, workspace or property sheet can be displayed or not displayed.

 Clause 3.4.1 Customizing screen configuration

## Screen

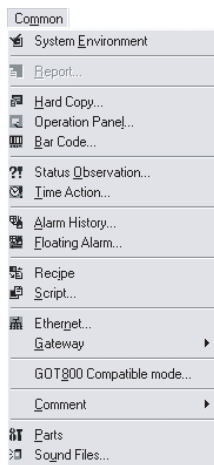


The Screen menu contains functions of screen management and settings in a project.

New screen creation, opening/closing screen and change of window size are available.

 Chapter 4 CREATING AND EDITING SCREEN

## Common



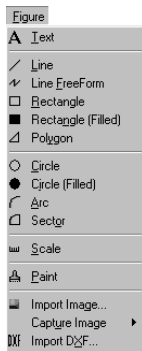
The Common menu contains functions of common settings.

The object functions used for the overall project can be set. Comment, part and voice, etc. can also be registered.

Refer to the manual below for details of common settings.

 GT Designer2 Version□ Reference Manual

## Figure



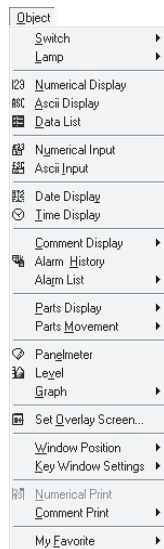
The Figure menu contains functions of drawing figures.

Various figures can be drawn or figures can be filled. Image data can also be imported.

 Chapter 8 DRAW AND EDIT



## Object

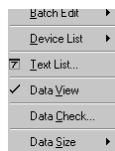


The Object menu contains functions of objects such as lamps or switches which are arranged on the screen.

Refer to the manual below for details of each object functions.

GT Designer2 Version□ Reference Manual

## Tools

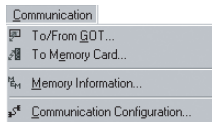


The Tool menu contains functions of list display of set devices and error check of setting items.

The data view can be displayed or not displayed.

Chapter 9 USEFUL FUNCTIONS

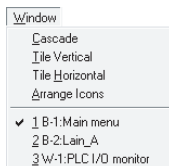
## Communication



The communication menu contains functions of download, upload, display of GOT memory information and communication settings.

Chapter 5 DATA TRANSFER OPERATION

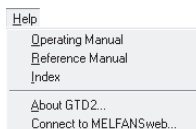
## Window



The Window menu contains functions of tiling multiple screens.

Clause 4.8 Operating Multiple Screens

## Help



The Help menu contains functions of viewing the PDF manual related to the GT Designer2 and checking the software version.

Clause 3.6 How to View the Product Information

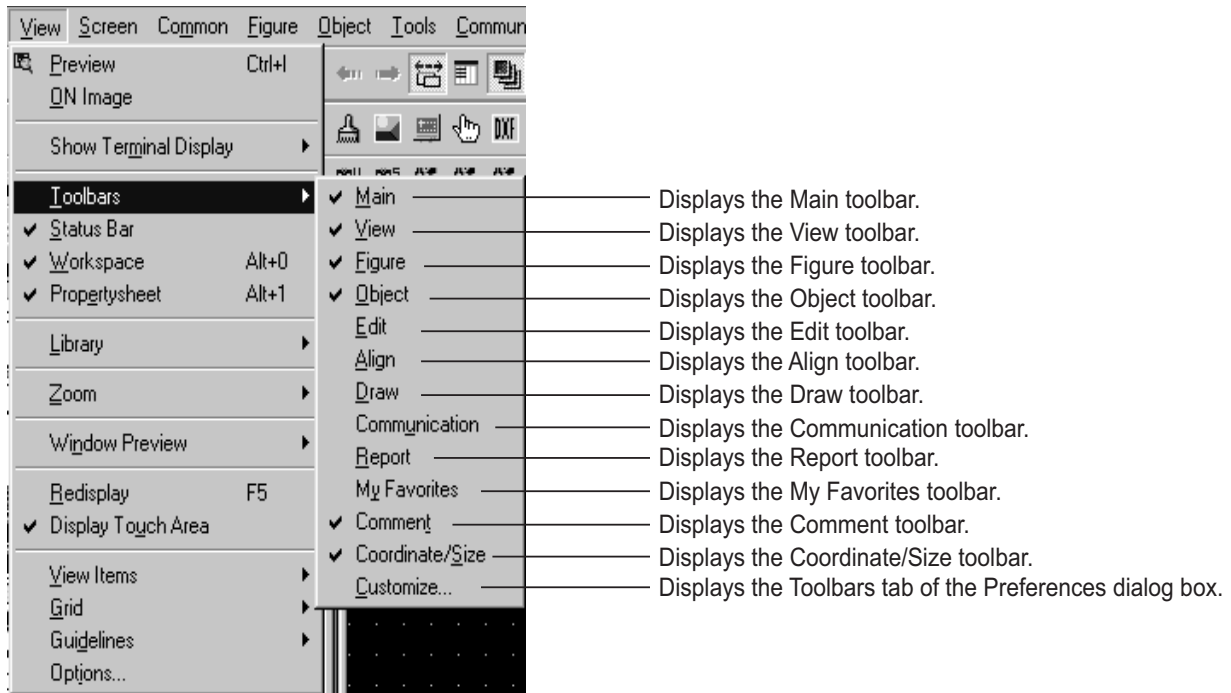
\* The commands in this chapter is shown for the case of the largest display of the GOT-A900 series. For the GOT-F900 series, there are some differences for each model, and some models do not display all commands.

## 3.3 Toolbars

### 3.3.1 Types of toolbars

The following types of toolbars are available.

When desired toolbars are checked for display/non-display, the toolbars can be displayed/non-displayed accordingly.







If you drag a displayed toolbar, it may be arranged as a window on the screen.

The following pages also describe details of each toolbar.

# 1 Main



Name	Description
 New	New project file is created.
 Open	Existing project file is opened.
 Save Project	Editing project is overwritten and saved on the existing file.
 New Base Screen	New base screen is created.
 Open Screen	Specified screen is opened.
 Cut	Figures and objects are cut.
 Copy	Figures and objects are copied.
 Paste	Figures and objects are pasted.
 Undo	The last operation is cancelled to recover the status before change.
 Redo	The last operation is repeated.
 Screen Preview	Settings are displayed with the display image on the GOT.
 Previous Screen	Screen with the number before the current screen number is opened.
 Next Screen	Screen with the number next to the current screen number is opened.
 UnOpened Screens	Unopened screen is opened with "Previous/Next Screen" in the ascending/descending order.
 Screen Device List	List of devices used is displayed.
 Data View	All figures and objects arranged on the screen are displayed in a list.
 Comment	Comment to be displayed with the object function is registered.
 Figure And Object	Objection of selection is switched to "Figure and Object."

## 2 View

Name	Description	
	Snap	Snap movement of the cursor is set.
	Zoom	Screen display magnification rate/shrinkage rate is set.
	Zoom In	Screen display can be zoomed in up to 400% in 10% increments.
	Zoom Out	Screen display can be zoomed out up to 50% in 10% increments.
	Grid Spacing	Grid interval is set.
	Grid Color	Grid color is set.
	ON Image, OFF Image	Screen is switched to the display of device ON/device OFF.
	Device, Object ID	Device (Dev.) and object ID (ID) are displayed for each object.
	Screen Color	Screen background color is set.
	Screen Pattern	Screen background pattern is set.
	Screen Background Color	Screen background color is set.
	Workspace	Workspace is displayed.
	Property Sheet	Property Sheet is displayed.






















### 3 Figure



Name	Description
 Line	Line is drawn.
 Line FreeForm	Continuous line is drawn.
 Rectangle	Rectangle is drawn.
 Rectangle (Filled)	Filled rectangle is drawn.
 Polygon	Polygon is drawn.
 Circle	Circle is drawn.
 Circle (Filled)	Filled circle is drawn.
 Arc	Arc is drawn.
 Sector	Sector is drawn.
 Scale	Scale is drawn.
 Text	Text is input.
 Paint	Polygon and closed area are painted with the selected pattern.
 Import Image	BMP format file is imported on the editing screen.
 Rectangular Range Area	Rectangular range area is captured.
 Window Area	Window area is captured.
 Import DXF	DXF format file is imported on the editing screen

## 4 Object



Name	Description
 Switch tool bar	Switch function is set.
 Bit Lamp	Bit Lamp function is set.
 Word Lamp	Word Lamp function is set.
 Numerical Display	Numerical Display function is set.
 ASCII Display	ASCII Display function is set.
 Numerical Input	Numerical Input function is set.
 ASCII Input	ASCII Input function is set.
 Time Display	Time Display function is set.
 Bit Comment	Bit Comment function is set.
 Word Comment	Word Comment function is set.
 Alarm History	Alarm History function is set.
 User Alarm	Alarm List function (User Alarm) is set.
 System Alarm	Alarm List function (System Alarm) is set.
 Bit Parts Display	Bit Parts Display function is set.
 Word Parts Display	Word Parts Display function is set.
 Fixed Parts Display	Fixed Parts Display function is set.
 Panel meter	Panel meter function is set.
 Level	Level function is set.
 Trend Graph	Trend Graph function is set.
 Line Graph	Line Graph function is set.
 Bar Graph	Bar Graph function is set.

## 5 Edit



Name	Description
Bring to Front	Selected figures and objects are arranged to front.
Send to Back	Selected figures and objects are arranged to back.
Group	Selected figures and objects are grouped.
Ungroup	Grouping is canceled.
Flip Horizontal	Selected figure is flipped horizontally.
Flip Vertical	Selected figure is flipped vertically.
Rotate Left	Selected figure is rotated 90 degrees to the left.
Rotate Right	Selected figure is rotated 90 degrees to the right.
Edit Vortex	Length of freeform line or polygon line is changed.
Align	Selected figures and objects are aligned.
Selection: Figure	Only figures are selected.
Selection: Object	Only objects are selected.
Selection: Figure and Object	Figures and objects are selected.
Adjust Direct Text Size	Text size of the target object is automatically adjusted with the size of object area.










## 6 Align



Name	Description
Align Left	Aligned with the selected leftmost figure or object.
Align Center (Horizontally)	Aligned at the center horizontally.
Align Right	Aligned with the selected rightmost figure or object.
Align Top	Aligned with the selected uppermost figure or object.
Align Center (Vertically)	Aligned at the center vertically.
Align Bottom	Aligned with the selected lowermost figure or object.
Align Across	Selected figures and objects are evenly aligned in the horizontal direction.
Align Down	Selected figures and objects are evenly aligned in the vertical direction.




## 7 Draw



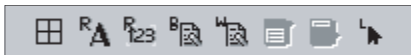
Name	Description
 Line Style	Line style is set or changed.
 Line Width	Line width is set or changed.
 Line Color	Line color is set or changed.
 Fill Pattern	Fill pattern is set or changed.
 Pattern Fg Color	Fill color is set or changed.
 Pattern Bg Color	Fill background color is set or changed.
 Text Color	Text color is set or changed.
 Text Style	Text style is set or changed.
 Text Solid Color	Text solid color is set or changed.









## 8 Communication



Name	Description
 To/From GOT	Data is transferred to GOT.
 To memory Card	Data is transferred to memory Card.
 Communication Configuration	Communication setting is made

## 9 Report











Name	Description
 Report Line	Report line (Rectangle) is drawn.
 Report Text	Report text is input.
 Numerical Print	Numerical value for report printing is set.
 Bit Comment Print	Comment (Bit) for report printing is set.
 Word Comment Print	Comment (Word) for report printing is set.
 Report Repeat Header	Header line is set.
 Report Repeat Line	Repeat line is set.
 Selection Report Line	Only report lines are selected.



## 10 Comment

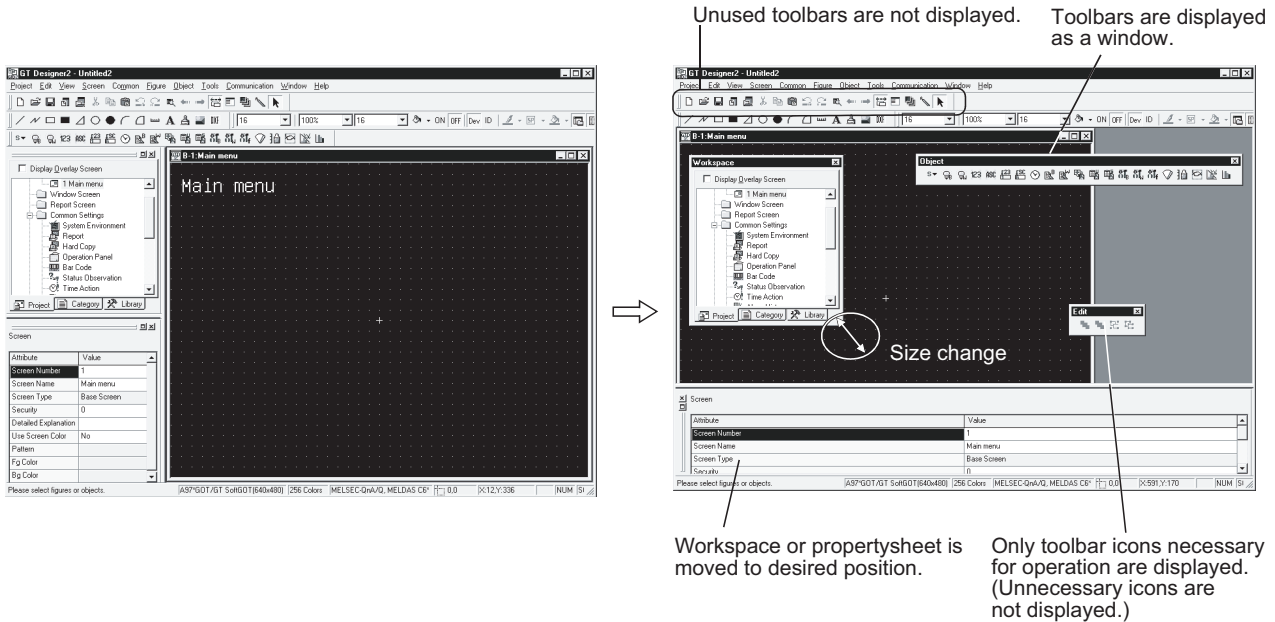


GT Designer2 Version□ Reference Manual

Name	Description
 New Comment	Adds a new comment line.
 Insert Row	Inserts a row in the specified position.
 Import	Imports the existing CSV, text or Unicode text file.
 Export	Exports a comment list to a CSV, text or Unicode text file.
 Attribute	Opens the comment attribute setting dialog.
 Search	Opens the character string search dialog.
 Jump	Opens the jump dialog.
 Attribute Display/Non-Display	Displays/Hides the attribute information.

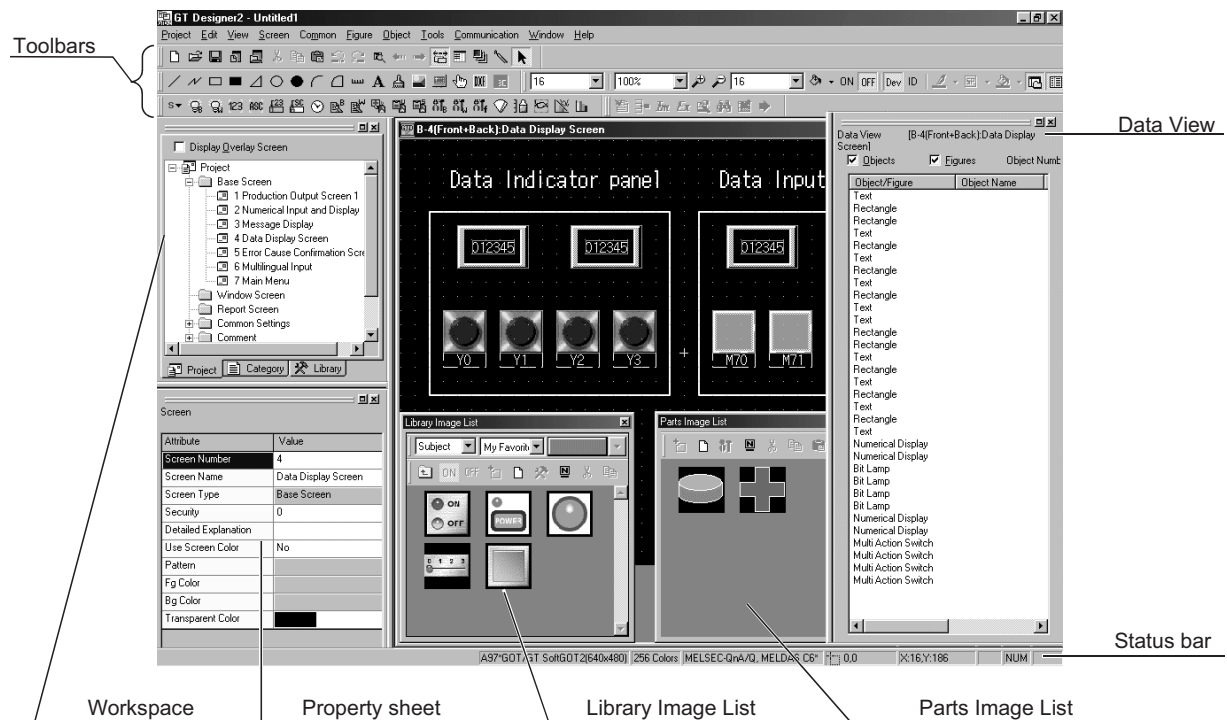
# 3.4 Customizing Screen Configuration and Toolbars

Screen configuration and toolbars can be customized on the GT Designer2 to facilitate operation by users. Screen configuration and toolbars customizing methods are described in this section.



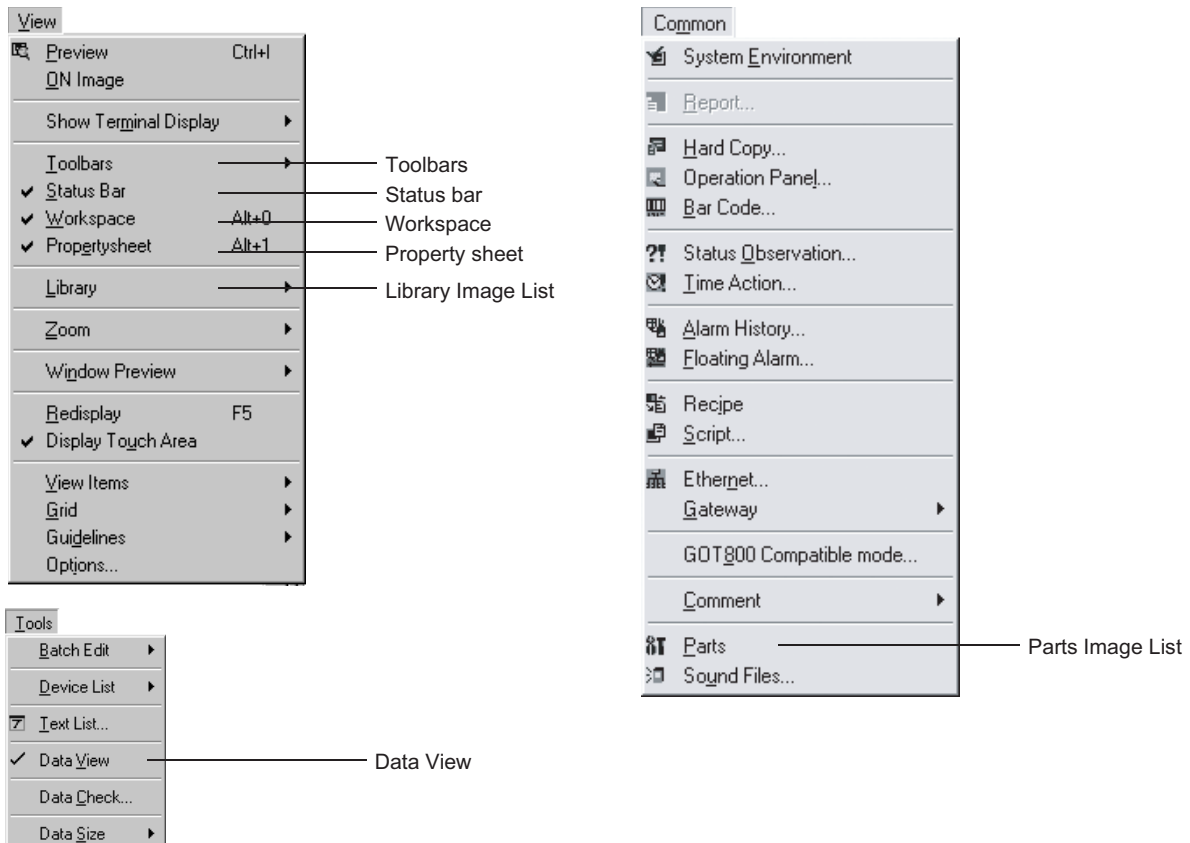
### 3.4.1 Customizing screen configuration

Display/non-display of tools, size change and display position change are available. The areas shown below can be customized.




#### 1 Display/non-display


Click the options in the menu below to display/non-display various tools.





## 2 Size change


Click the buttons below to change the screen size:

: The selected screen is minimized.

: The selected screen is returned to the original size.

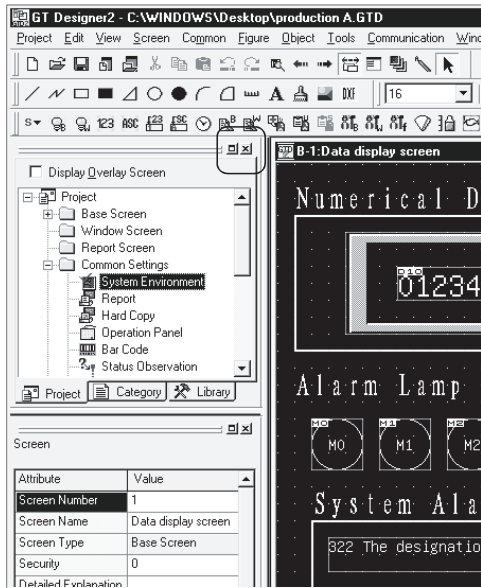
: The selected screen is maximized.

: The selected screen is closed.

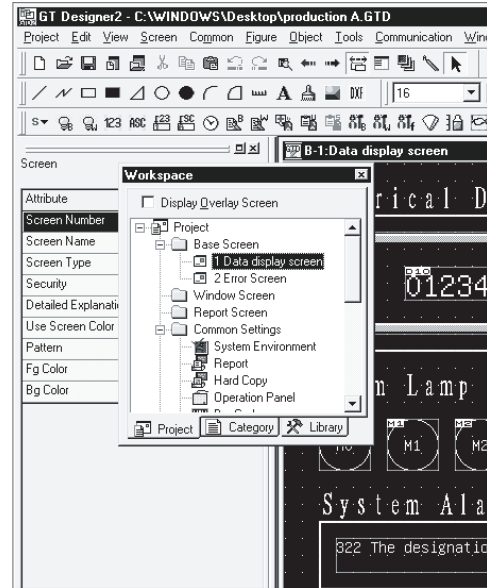
Click  to pop up the workspace, property sheet and data view.

(Ex.) Moving or changing size of workspace

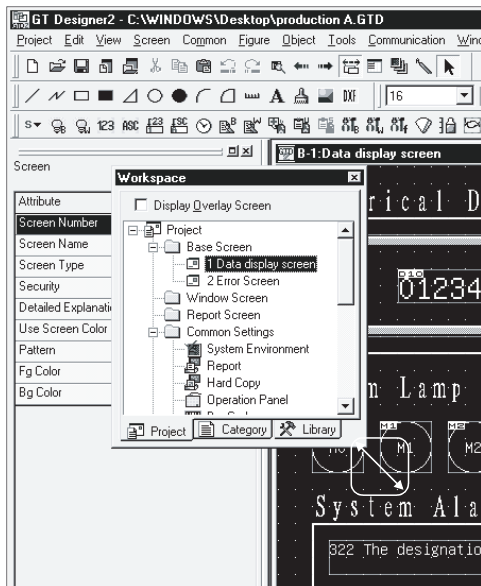
1 Click .



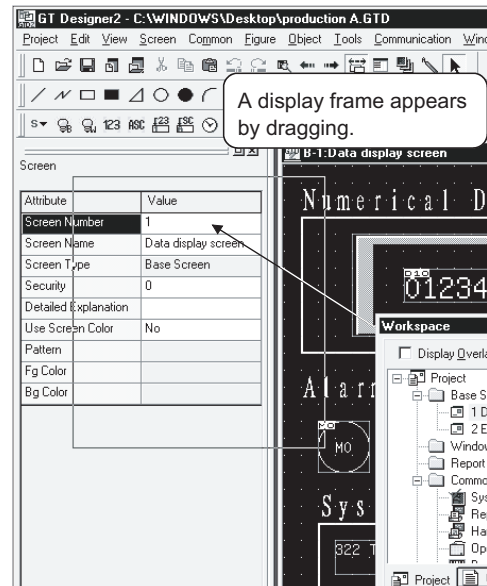
2 The workspace pops up as a window.



3 Change the window size of the workspace.  
(Toolbars size cannot be changed.)



4 When it is dragged to the original position, full display can be recovered.



### **Remark**

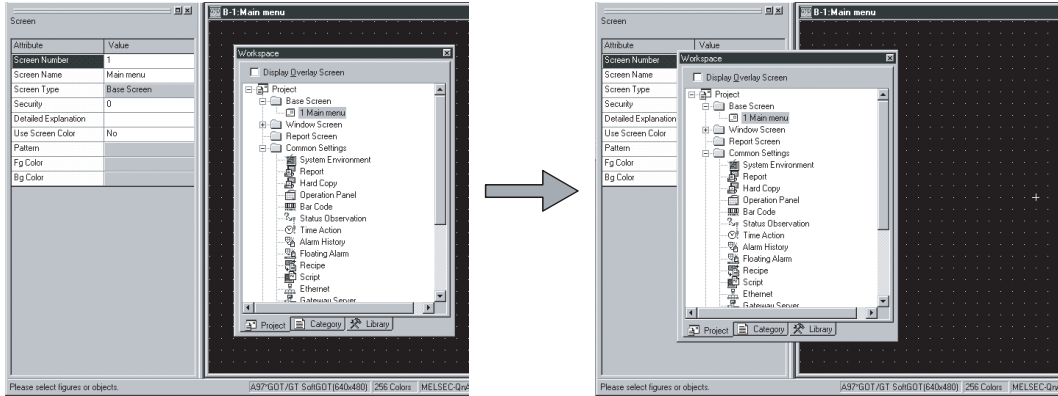
Customized screen

The GT Designer2 memorizes the customized settings of the screen configuration. At the next start-up, the previously customized status screen is displayed.



### Movement of workspace

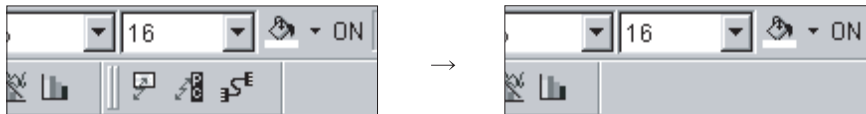
Drag the popped-up workspace while holding the Ctrl key down. This enables the workspace to be moved without being fully displayed.



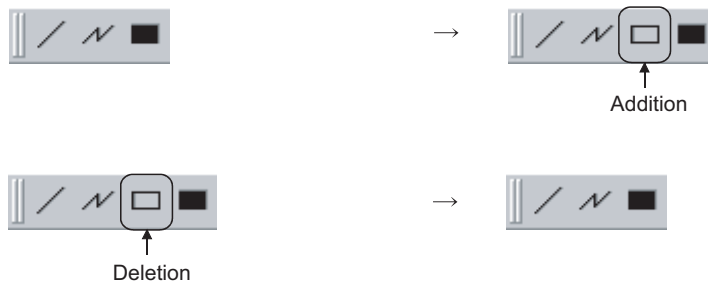
## 3.4.2 Customizing toolbars

An icon/toolbar can be added or deleted, and the icon display can be changed. Refer to the following pages for operation.

(Ex. 1) Deletion of toolbars



(Ex. 2) Addition/deletion of icon



(Ex. 3) Movement of icon



(Ex. 4) Icon grouping with partition



## 1 Adding or deleting toolbars/icons

Methods of adding or deleting toolbars/icons are shown below:

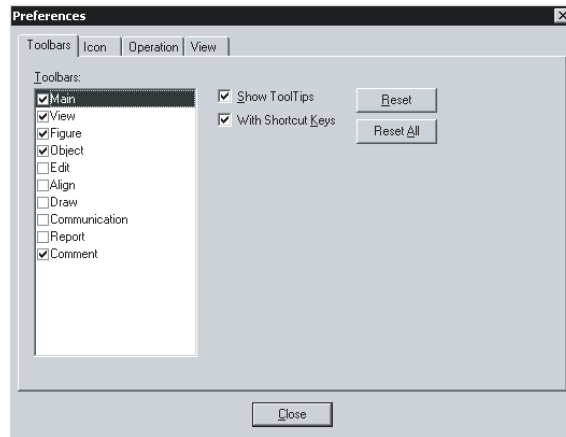
1 Select [Project] → [Preferences].

2 The preferences dialog box appears.

Add or delete toolbars/icons with the toolbar tab or the command tab.

### ■ Toolbars tab

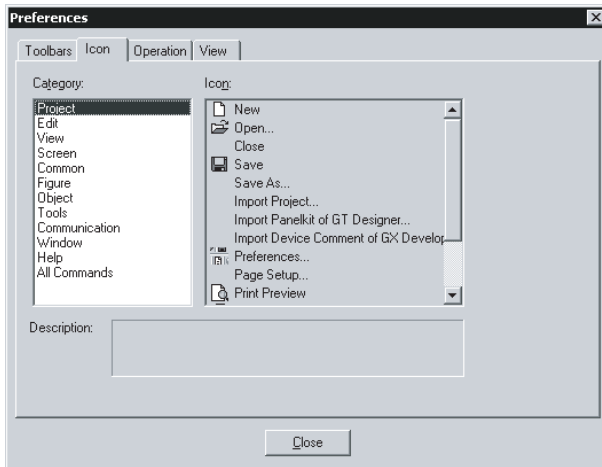
Toolbars are added or deleted.



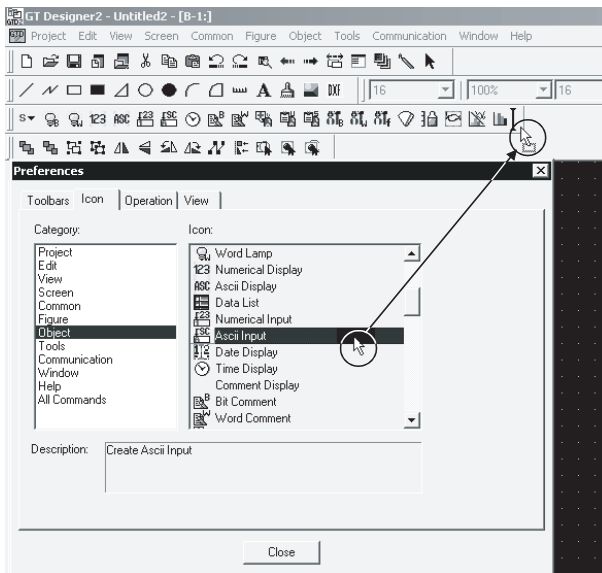
Item	Description	A	F
Toolbars	Check the desired toolbars for addition. To delete it, remove the check.	<input type="radio"/>	<input type="radio"/>
Show Tool Tips	When the cursor is placed on the icon, check this to display the icon name.	<input type="radio"/>	<input type="radio"/>
With Shortcut Keys	When the cursor is placed on the icon, check this to display the shortcut key. (It is effective only when the "Show Tool Tips" is displayed.)	<input type="radio"/>	<input type="radio"/>
Reset	Only the selected toolbars are set to default status.	<input type="radio"/>	<input type="radio"/>
Reset All	All toolbars are set to default status.	<input type="radio"/>	<input type="radio"/>

■ Icon tab

Icons are added, deleted or moved with the procedures below:

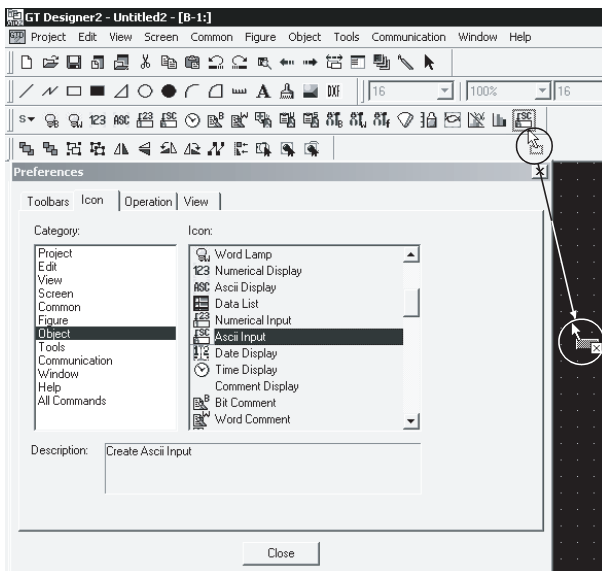


(Ex. 1) Adding icon



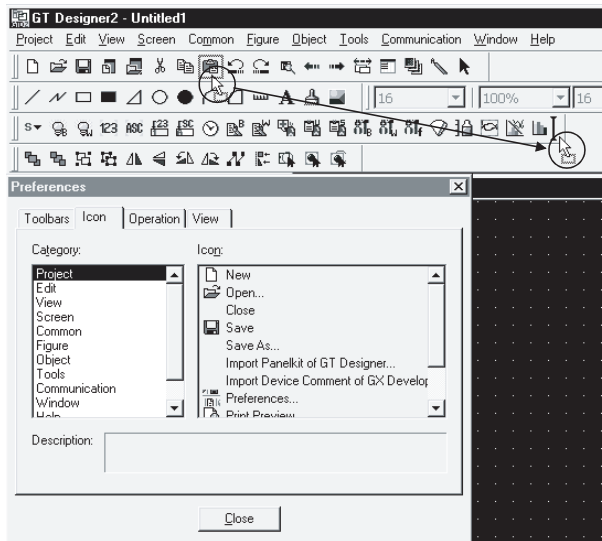
Click the desired function for addition and drag it to the desired toolbar.

(Ex. 2) Deleting icon



Click the desired icon for deletion and drag it outside the toolbar.

### (Ex. 3) Moving icon



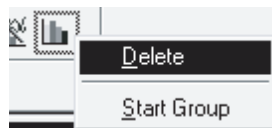
Select the desired icon for movement and drag it to the desired position.

- 3 When the toolbars are changed, click the **Close** button.



#### Deleting icon and inserting partition

While the preferences dialog box is open, select the icon and right click the mouse to delete icon or to insert partition.



**Delete** : Delete the selected icon.

**Start Group** : Insert a partition at the left of the icon.

It is convenient to group with icons.

When all icons at the right of the partition are deleted, the partition is deleted as well.

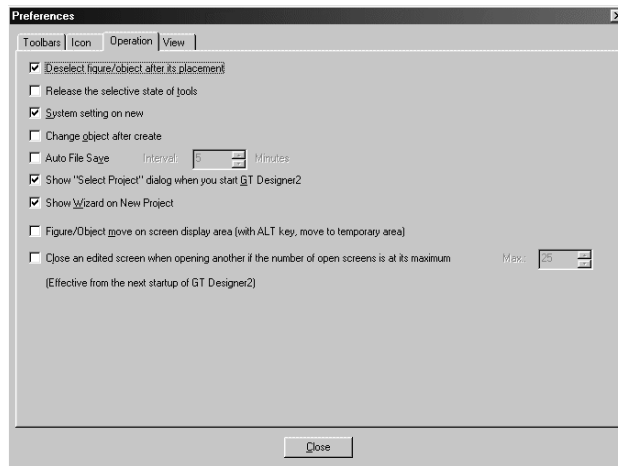


### 3.4.3 Customizing GT Designer2 operating environment

Environment for the drawing screen is set.

- 1 Select [Project] - [Preferences] menu.
- 2 The preferences dialog box appears.  
The drawing screen environment is set with operation tab/display tab items.

- 1 Operation tab  
Operation setting for drawing screen is made.

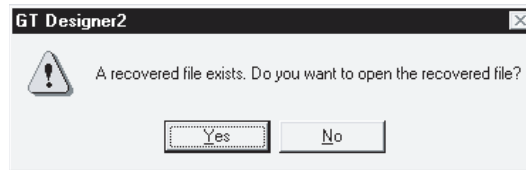


Item	Description	A	F
Deselect figure/object after its placement	Checked : After arranging objects, the selected status (status with handle) is reset. Not checked : With the selected status (status with handle), figures/objects are arranged on the drawing screen.	<input type="radio"/>	<input type="radio"/>
Release the selective state of tools	Checked : After setting figures/objects, the tool selected status is reset. It is convenient to arrange different figures/objects. Not checked : After setting figures/objects, the selected status remains active. It is convenient to arrange the same figures/objects continuously.	<input type="radio"/>	<input type="radio"/>
System setting on new	Checked : The system settings dialog box (GOT type, PC type, etc.) appears in creation of a new project. Not checked : The system settings dialog box (GOT type, PC type, etc.) does not appear in creation of a new project.	<input type="radio"/>	<input type="radio"/>
Change object after create	Checked : After arranging objects on the drawing screen, the settings dialog box automatically appears. Not checked : After arranging objects on the drawing screen, the settings dialog box does not automatically appear.	<input type="radio"/>	<input type="radio"/>
Auto File Save	Checked : File is automatically saved. Saving interval (5 to 720) is set. Not checked : File is not automatically saved.	<input type="radio"/>	<input type="radio"/>
Show "Select Project" dialog when you start GT Designer2	Checked : When the GT Designer2 is started, the project selection dialog box (New, Open, etc.) appears. Not checked : When the GT Designer2 is started, the project selection dialog box (New, Open, etc.) does not appear.	<input type="radio"/>	<input type="radio"/>
Show Wizard on New Project	Checked : The wizard is displayed when a new project is created. Not checked : The wizard is not displayed when a new project is created.	<input type="radio"/>	<input type="radio"/>
Figure/Object move on screen display area (with ALT key, move to temporary area)	Checked : A figure or object can be moved on the screen display area by dragging. When dragged pressing the ALT key, it can be moved to the temporary area. Not checked : A figure or object can be moved to the temporary area by dragging. When dragged pressing the ALT key, it can be moved on the screen display area.	<input type="radio"/>	<input type="radio"/>

Item	Description	A	F
Close an edited screen when opening another if the number of open screens is at its maximum (Effective from the next startup of GT Designer2)	Set the maximum number of screens (1-25 screens). Setting values will be enabled at the next startup.	○	○

(1) Operation in automatic save setting

If the GT Designer2 stops or a power failure occurs in automatic save setting, the GT Designer2 shows the dialog box below at the next start-up.



- If a project file is available (a project is saved in the past), this dialog box appears when the project file is opened.
- If a project file is not available (no saving after new creation), this dialog box appears when the GT Designer2 is started.

When  Yes is selected on the dialog box above, the automatically saved file is recovered.

When either  Yes or  No is selected, the automatically saved recovery file is erased.

It is advisable to select  Yes, and store the restored project data as necessary. If the data is unnecessary, do not save them and then close the project.

(2) Precautions for multiple start of GT Designer2 with automatic save setting

When automatic save is set, do not perform the following (a), (b) operations.

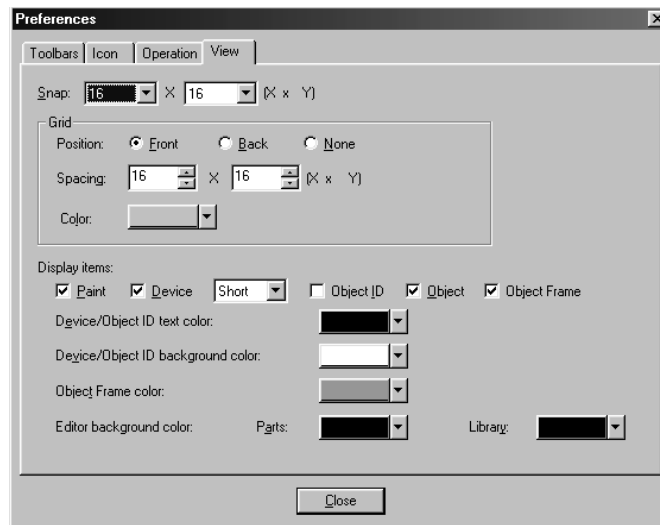
The message in (1) above appears at the start-up of the 2nd or subsequent GT Designer2 and the automatically saved file is then erased.




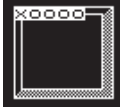
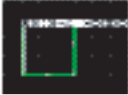


Reset the automatic save for the following (a), (b) operations:

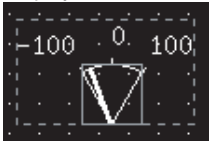



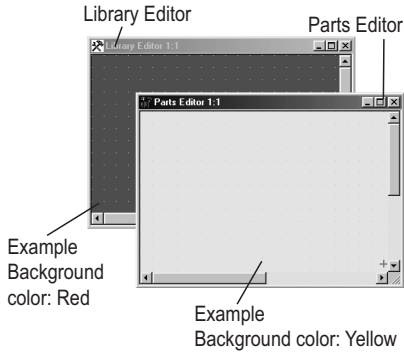
- After new creation, start the 2nd or subsequent GT Designer2 while editing a project which has not been saved at all.
- Open the project which has been opened on the GT Designer2 with the 2nd or subsequent GT Designer2.

## 2 View tab

Display for the drawing screen is set.



Item		Description	A	F
Snap *1		Dot value (1, 2, 4, 8 or 16) is selected for automatic arrangement of figures or objects on the screen.	<input type="radio"/>	<input type="radio"/>
Grid	Position	Position of grid display is selected. Front : Grid is displayed at the front of the screen. Back : Grid is displayed at the back of the screen. None : Grid is not displayed.  (Ex.)   Front Back	<input type="radio"/>	<input type="radio"/>
	Spacing	Grid spacing (2 to 64 dots) is set.	<input type="radio"/>	<input type="radio"/>
	Color	Grid display color is selected.	<input type="radio"/>	<input type="radio"/>
Display items		Items displayed on the GT Designer2 are checked.	<input type="radio"/>	<input type="radio"/>
Paint		When a closed figure is filled with "Paint," this item is selected to display the filled status.  (Ex.) Filling in white 	<input type="radio"/>	<input type="radio"/>
Device	Short	This item is selected to display the device name set in the object.  (Ex.) x 1000 	<input type="radio"/>	<input type="radio"/>
	Full	This item is selected to display CH.NO,NW.NO,PC station number, and the device name set in the object.  (Ex.) @2:3-4_x 0000 	<input type="radio"/>	<input type="radio"/>
Object ID		This item is selected to display the object ID of each object. The object ID is automatically put on each object. It is convenient to display the object ID in setting the system information. Refer to the manual below for details of system information.   GT Designer2 Version <input type="checkbox"/> Reference Manual 	<input type="radio"/>	<input type="radio"/>

Item		Description	A	F
Display items				
Object	This item is selected to display the set object.		<input type="radio"/>	<input type="radio"/>
			(Ex.) Display of level 	
Object Frame	Select this item to display the boundary of the object.		<input type="radio"/>	<input type="radio"/>
Device/ Object ID text color	Specify the text color of the object or object ID. Text color: Black		<input type="radio"/>	<input type="radio"/>
			(Ex.) Object ID text color: Black 	
Device/ Object ID background color	Specify the text background color of the object or object ID. Background color: White		<input type="radio"/>	<input type="radio"/>
			(Ex.) Text background color of the object ID: White 	
Object Frame color	Specify the color of the object boundary. If the same transparent color as one used previously is specified for the front layer, it will appear transparent, so specify the layer's transparent color and another color.		<input type="radio"/>	<input type="radio"/>
			Object Frame 	
Editor background color	Parts	The background color for the Parts Editor is selected. The background color is selectable from 256 colors.	<input type="radio"/>	<input type="radio"/>
	Library	The background color for the Library Editor is selected. The background color is selectable from 256 colors.	<input type="radio"/>	<input type="radio"/>
			Library Editor Parts Editor  Example Background color: Red Example Background color: Yellow	

Refer to the next page for details of \*1.

### \*1 Snap

Figures and objects are arranged with the dot value set in "Snap."

(Ex.)

Drawing a rectangle ([Snap] is set to 16 dots.)





- ① Determine the start point by clicking. → ② Actual start position







Cursor position  
(X=10, Y=12)



It is arranged at the closest position to the coordinates of multiples of 16. (X=16, Y=16)

- When the end point is determined, the cursor can only be moved to the coordinates of multiples of 16.
- When an object display position is determined or a figure is moved, the cursor moves based on the dot value set in [Snap] as shown above.
- One stroke of the  key,  key,  key and  key on the keyboard moves the cursor in the units of the set dot value.

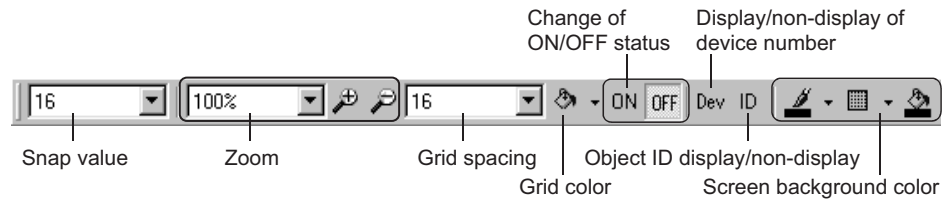
Set the [Snap] to one dot each and hit  key,  key,  key and  key each time on the keyboard to move the cursor 1 dot each. This facilitates drawing a fine figure or position setting.



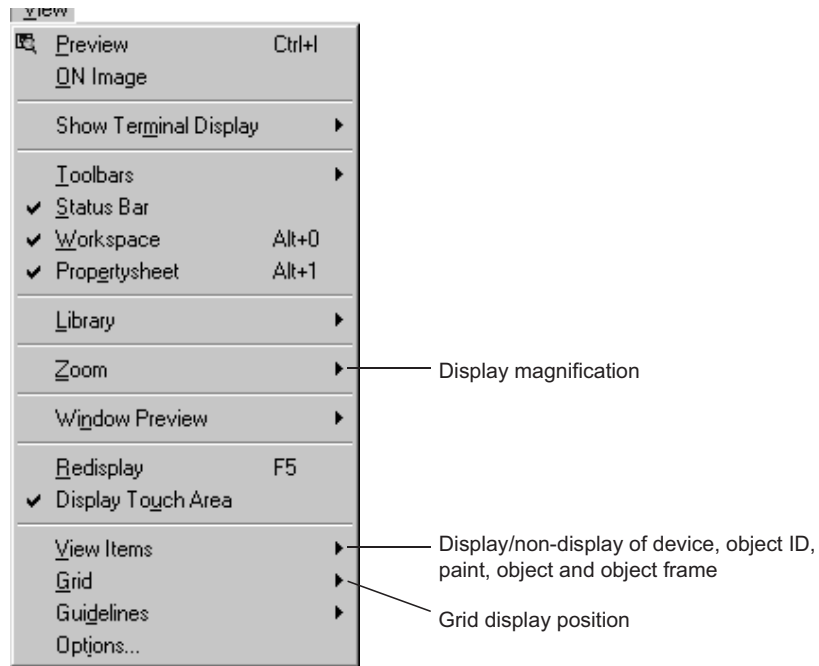
## Display change from toolbars and menu

Items set on the display tab can be changed from toolbars and menu.

### (1) Changing drawing screen display from toolbars (display setting)

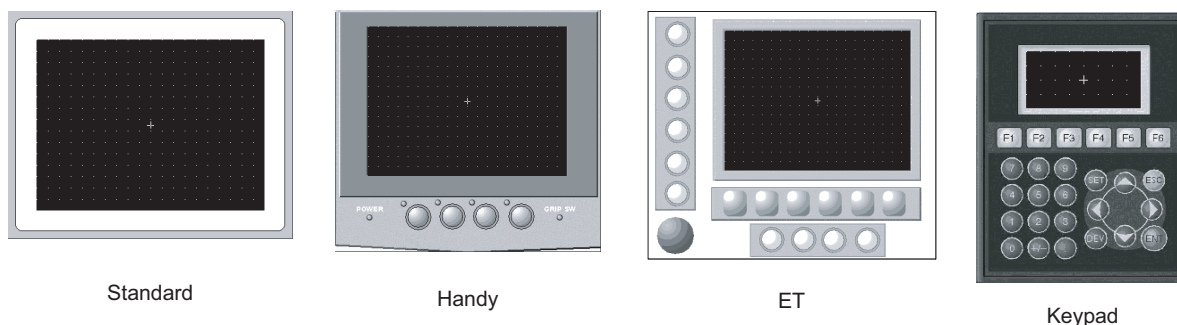


### (2) Changing drawing screen display from menu



### 3.4.4 Display with frame

It is the function to display the outer frame on the drawing screen as if the GOT body frame is imaged. With this function, a screen can be created with the image of the GOT body.

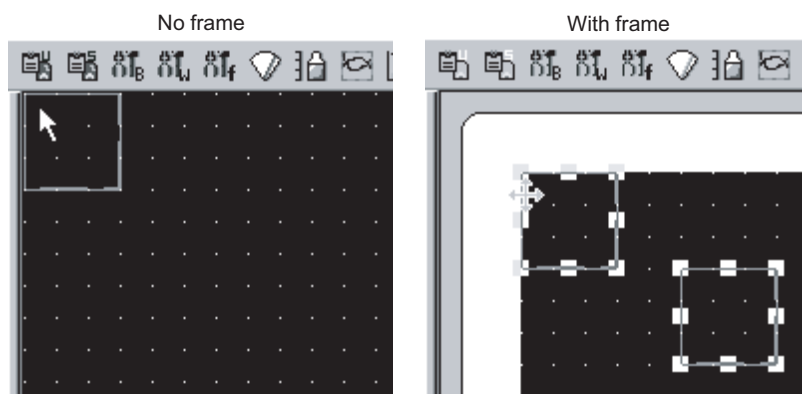


- Standard.....Selectable on all GOT (except F920GOT (128 × 64)).  
(This is not displayed on the GT SoftGOT.)
- Handy.....Selectable when the GOT type is set to A95\*GOT (320 × 240) or F94\*GOT (320 × 240).
- ET .....Selectable when the GOT type is set to A94\*GOT (320 × 240).
- Keypad.....Selectable when the GOT type is set to A920\*GOT (128 × 64) or A930\*GOT (240 × 80).

- 1 Select [View] → [Display with Frame] → [Standard]/[Handy]/[ET]/[Keypad] menu.
- 2 The frame is displayed according to the selected option.

#### 1 Standard

This function allows an image of the GOT body on the drawing screen. It is easy to edit a figure at a screen end.



#### 2 Handy, ET and Keypad

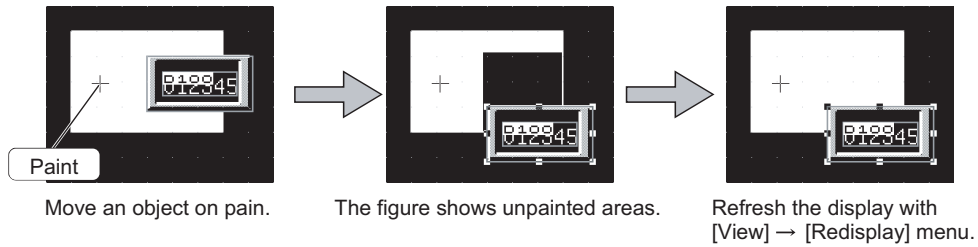
This function allows an image of the GOT body on the drawing screen. When a switch or an LED on the body image is clicked, device assignment for the operation switch LED or the function switch and switch function for the function switch can be set. It is easy to edit a figure at a screen end.

## 3.4.5 Redisplaying drawing screen

---

If paint is used, unpainted areas may occur.  
Redisplay provides correct display.

Ex.) Moving an object on paint



- 1 Select the [View] → [Redisplay] menu.
- 2 Display the drawing screen correctly.



## 3.5 How to use Help

Help displays the GT Designer2 relevant PDF manuals and the software version.



Before viewing the PDF manual

To view the PDF manual, GT Manual and Adobe® Reader® must be installed.

### 1 Operation method

1 Click the corresponding menu within [Help].

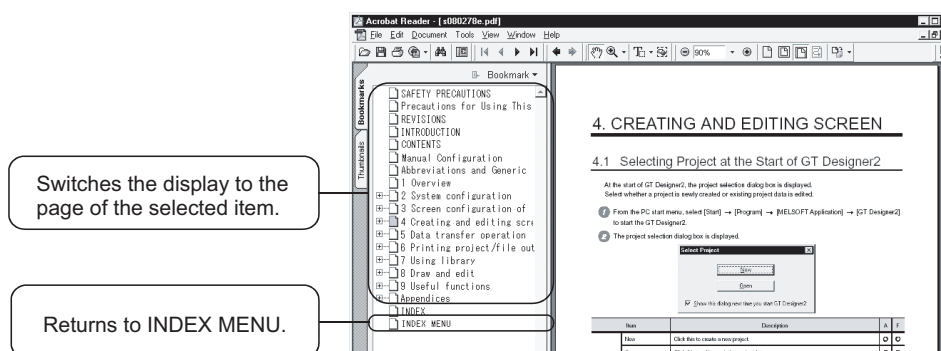
Item	Description	GOT1000 Series	GOT900 Series
[Operating Manual]	Displays the GT Designer2 Version□ Operating Manual	—	○
[Reference Manual]	Displays the GT Designer2 Version□ Reference Manual	—	○
[Basic Operation/Data Transfer Manual]	Displays the GT Designer2 Version□ Basic Operation/Data Transfer Manual.	○	—
[Screen Design Manual]	Displays the first/second volume of the GT Designer2 Version□ Screen Design Manual.	○	—
[Index]	Displays the PDF manual list.	○	○
[About GTD2...]	The GT Designer2 version can be confirmed.	○	○
[Connect to MELFANweb...]	Connects to the Mitsubishi Electric FA Equipment Technology Information Service MELFANSweb home page.	○	○

### 2 PDF manual viewing procedure (When [Operating Manual]/ [Reference Manual] is selected.)

1 The selected manual is displayed.

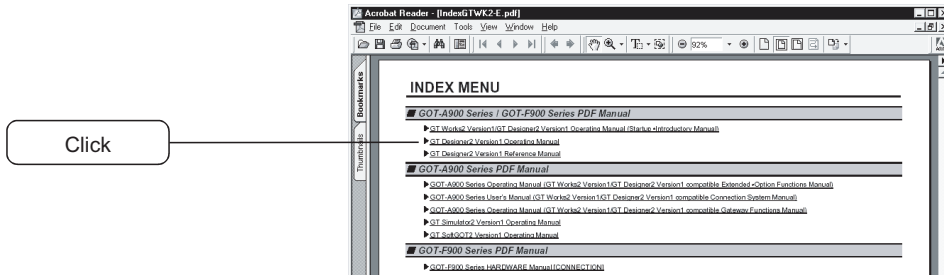
(For details of the Adobe® Reader® operation method, refer to Help of Adobe® Reader®.)

Clicking INDEX MENU displays the manual list (This section 3 1).

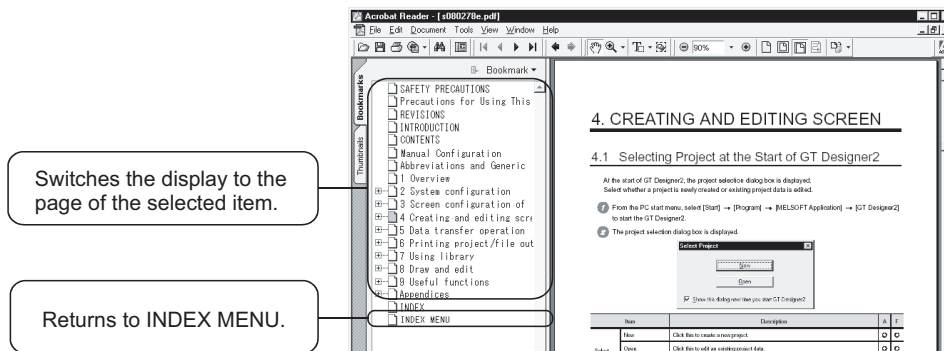


### 3 PDF manual viewing procedure (When [Index] is selected.)

1 After performing operation in 1, the following screen appears. Click the manual to be viewed.

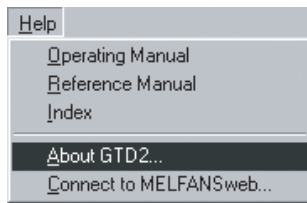


2 The selected manual is displayed.  
(For details of the Adobe® Reader® operation method, refer to Help of Adobe® Reader®.)

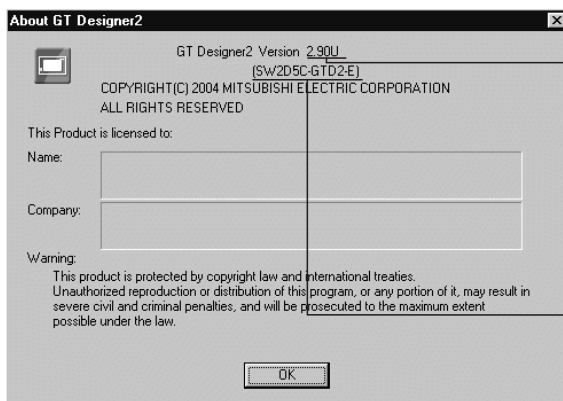


## 3.6 How to View the Product Information

The product information can be viewed in the following procedure.



- 1 Choose the [Help] - [About GTD2] menu.



- 2 The screen (About GTD2) shown on the left appears.

Version  
2.90U  
Minor version of GT Designer2  
Major version of GT Designer2

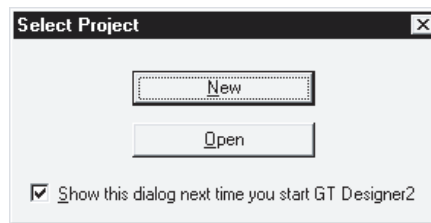
Product model name  
SW□D5C-GTD2-E  
Major version of GT Designer2

# 4. CREATING AND EDITING SCREEN

## 4.1 Selecting Project at the Start of GT Designer2

At the start of GT Designer2, the project selection dialog box is displayed. Select whether a project is newly created or existing project data is edited.

- 1 From the PC start menu, select [Start] → [Program] → [MELSOFT Application] → [GT Designer2] to start the GT Designer2.
- 2 The project selection dialog box is displayed.



Item		Description	A	F
Select project	New	Click this to create a new project.	<input type="radio"/>	<input type="radio"/>
	Open	Click this to edit an existing project data.	<input type="radio"/>	<input type="radio"/>
	Show this dialog next time you start GT Designer2	When you do not want to display this dialog box at the next start of the GT Designer2, uncheck this.	<input type="radio"/>	<input type="radio"/>

- 3 The operation proceeds to the following depending on the items selected.

New : Set [System environment] of a new project.

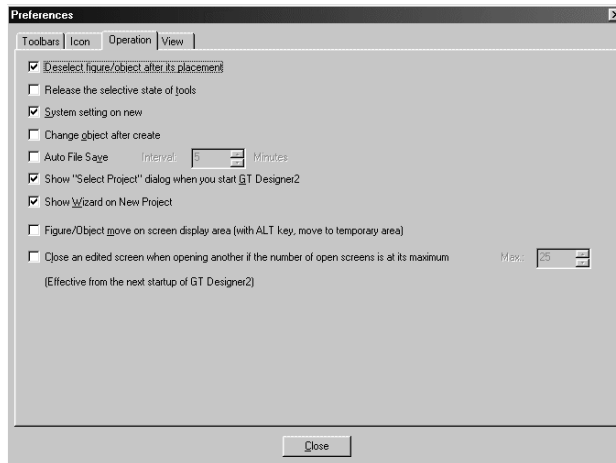
☞ Section 4.3 Opening/Closing Project

Open : Specifying a project save source for editing

☞ Section 4.4 Setting the Project Title

When the Select project dialog box is not displayed at the time of GT Designer2 start  
Make the following settings.

- 1 Choose the [Project] → [Preference] Operation tab.
- 2 Put a check mark in "Show Select project dialog when you start GT Designer2"  
On the Operation tab within the Preference dialog box.



- 3 Click the **Close** button.

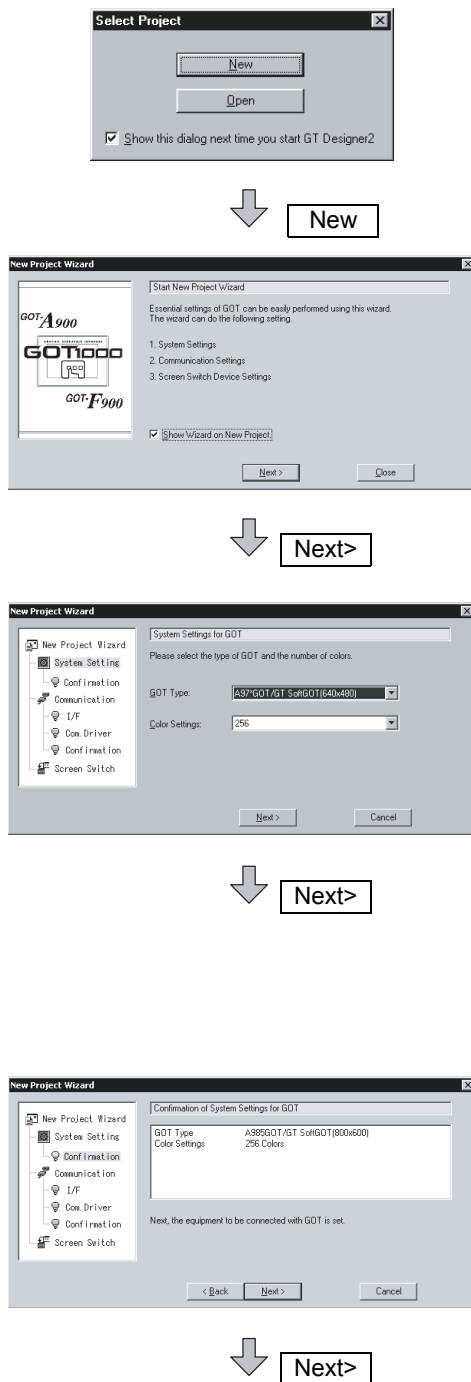
## 4.2 Creating a New Project

When a new project is created, the settings can be done using a wizard, or not using a wizard.

### 1 Using a wizard

At the Operations tab of the Preferences dialog box, if the "Show Wizard on New Project" box is unchecked, the New Project Wizard does not start.

If the wizard is used, select the Operations tab at "Project" → "Preferences" and check the "Show Wizard on New Project" button.



- 1 The screen on the left is displayed when GT Designer2 starts. Click the **New** button to create a new project.

- 2 The initial screen of the Start New Project Wizard is displayed.

**Next >** button : The wizard advances through each setting screen.

**Close** button : Click this to cancel the wizard.

\* If "Show Wizard on New Project" is unchecked, the wizard will not appear the next time a new project is created.

- 3 The screen on the left (System Settings for GOT) is displayed. Select the appropriate GOT type and color setting. 111

Item	Contents
GOT Type	Select the appropriate GOT type
Color Settings	Select a display color that matches the GOT setting. On the GT Designer2 usable colors are specified.

**Next >** button : Advance to the next screen.

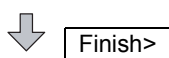
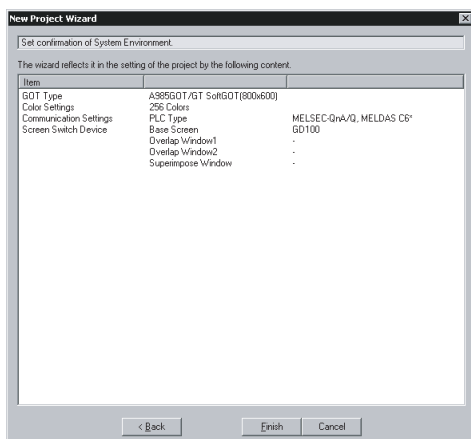
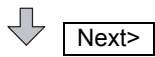
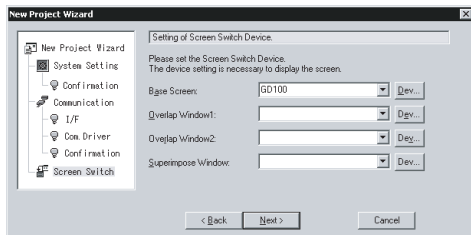
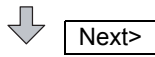
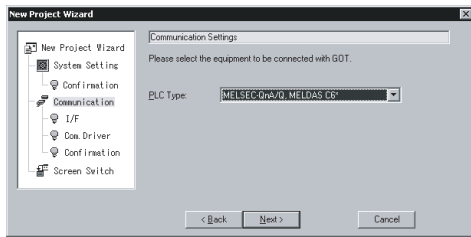
**Close** button : Cancel the settings and quit the wizard.

- 4 The screen on the left (Confirmation of System Settings for GOT) is displayed. Confirm the settings.

**Back** button : Go back to the previous screen.

**Next >** button : Advance to the next screen.

**Close** button : Cancel the settings and quit the wizard.



5 The screen on the left (Communication Settings) is displayed.

Select the connection PLC Type.

**Back** button : Go back previous screen.

**Next>** button : Advance to the next screen.

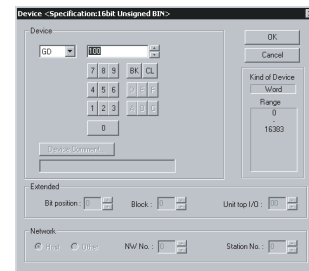
**Cancel** button : Cancel the settings and quit the wizard.

6 The screen on the left (Setting of Screen Switch Device) is displayed.

Click the **Device** button and set the Base Screen exchange device displayed at the GOT.

Also, if necessary, set the Overlap Window and Superimpose Window screen change device.

Device Setting dialog box display example



**Back** button : Go back to the previous screen.

**Next>** button : Advance to the next screen.

**Cancel** button : Cancel the settings and quit the wizard.

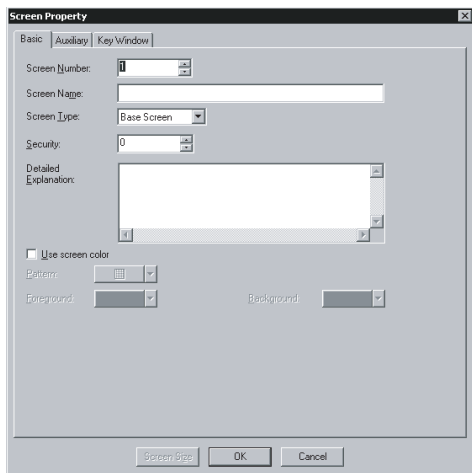
7 The screen on the left (Communication of System Environment) is displayed.

Confirm the setting.

**Back** button : Go back one screen.

**Next>** button : Complete making settings using the wizard, and the screen property dialog box is displayed.

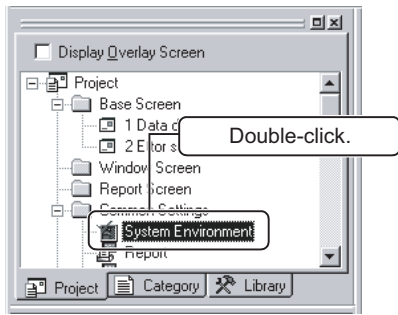
**Cancel** button : Cancel the settings and quit the wizard.



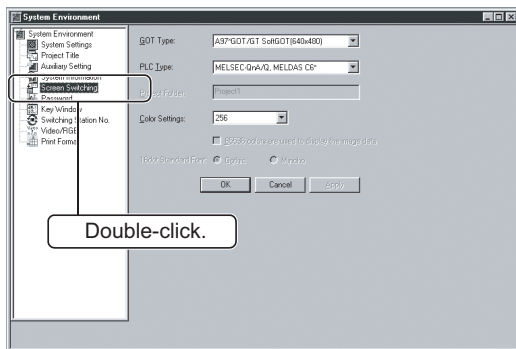
- 8 The screen property dialog box is displayed. Input the screen home.
- 9 Click the **OK** button to create base screen 1.



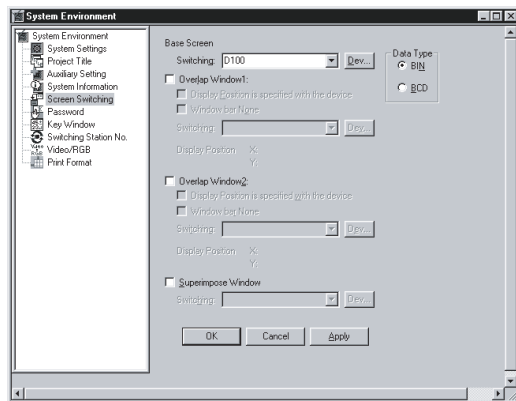
(2) Screen switching device setting method



- 1 Double-click [Common Settings] – [System Environment] in the project workspace.



- 2 As the System Environment dialog box is displayed, double-click [Screen Switching].



- 3 As the Screen Switching Device Settings dialog box is displayed, set [Base Screen Switching].


Set data

Base Screen Switching: D100


- 4 Clicking the **OK** button completes the setting of the screen switching device.

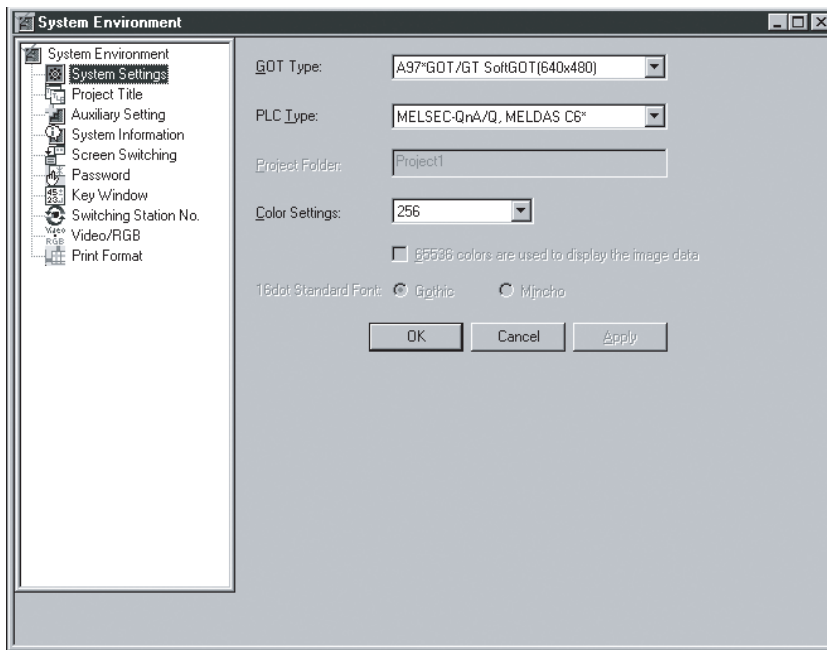
**2** If the wizard is not being used


**1** Perform either of the following operations.

- Click  (New).
- Select [Project] → [New] menu.

**2** The system environment dialog box appears. Perform the system settings.  
For items other than [System settings], refer to the manual below:

 GT Designer2 Version□ Reference Manual



Item		Description	A	F
System settings	GOT type	The GOT type to be used is set.	○	○
	PLC type	The PLC type to be connected is set. Refer to the manual below for details of the PC type.  GT Designer2 Version□ Reference Manual	○	○
	Project Folder	Not available for creating the GOT900 series project.	—	—
	Color settings	Screen color displayed on the GOT is set. Select the color according to the GOT display color.	○	○
	Use 65536 colors for image data display	Not available for creating the GOT900 series project.	—	—
	16 dot Standard Font	Not available for creating the GOT900 series project.	—	—



**Change of GOT type**

Refer to the manual below for cautions when changing GOT type.

 GT Designer2 Version□ Reference Manual

**3** After system settings, click the **OK** button to go to operation of New Screen.

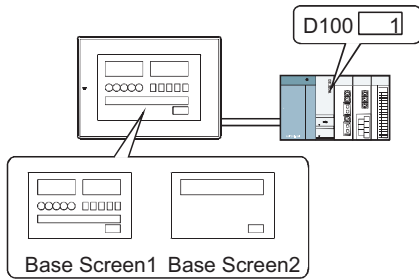
 Section 4.5 Creating a New Screen

### 3 Setting the screen switching device

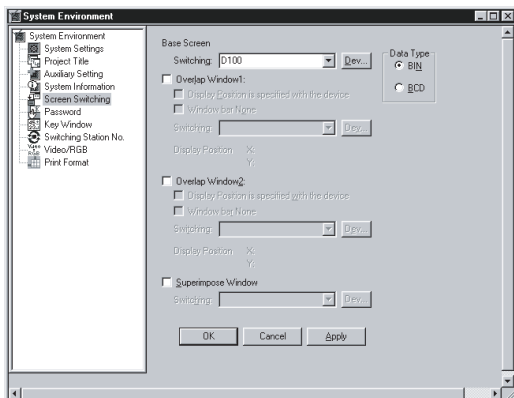
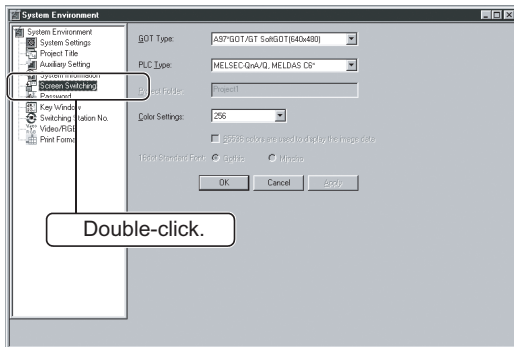
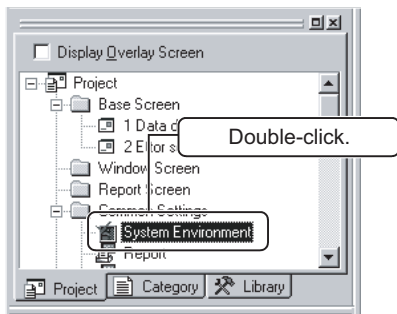
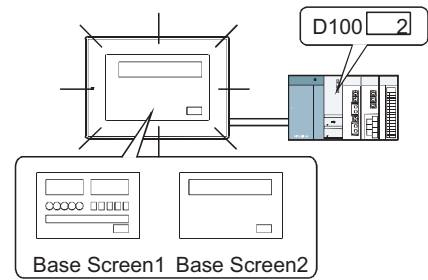
#### (1) What is screen switching device?

A screen switching device is a word device used to switch the screen on the GOT. The GOT switches to the screen of the numeric value stored in the screen switching device. Use the screen switching device for screen switching only.

When the value of the screen switching device is 1, the GOT displays Base Screen 1.



When the value of the screen switching device turns from 1 to 2, the GOT displays Base Screen 2.



- 1 The screen on the left is displayed when GT Designer2 starts. Click the **New** button to create a new project.

- 2 The initial screen of the Start New Project Wizard is displayed.

**Next>** button : The wizard advances through each setting screen.

**Close** button : Click this to cancel the wizard.

\* If "Show Wizard on New Project" is unchecked, the wizard will not appear the next time a new project is created.

- 3 The initial screen of the Start New Project Wizard is displayed.

**Next>** button : The wizard advances through each setting screen.


**Close** button : Click this to cancel the wizard.

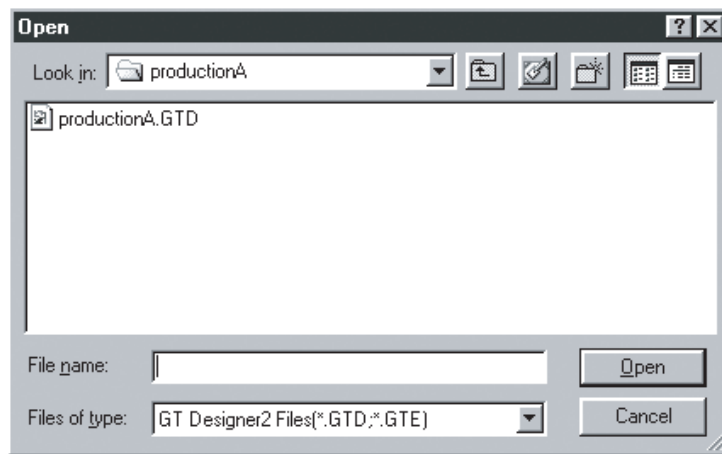
\* If "Show Wizard on New Project" is unchecked, the wizard will not appear the next time a new project is created.


## 4.3 Opening/Closing Project

### 4.3.1 Opening project

A saved project data is read from the project save source.

- 1 Perform either of the following operations.
  - Click  (Open).
  - Select [Project] → [Open] menu.
- 2 The open dialog box is displayed.



Item	Description	A	F
Look in	Select the location where the project is saved.	○	○
File name	Set the project name for opening.	○	○
Files of type	<ul style="list-style-type: none"> <li>• Select the project type to be opened.</li> <li>• GT Designer2 Files (*.GTD, *.GTE); The GT Designer2 project data will be opened.</li> <li>- *.GTD: GOT-900 series</li> <li>- *.GTE: GOT-1000 series</li> <li>• GT Designer Files (A9GOTP.GOT); The GT Designer project data for GOT-900 series will be opened.</li> <li>• DU-Win Files (*.DUP); The DUWin project data for GOT-F900 series will be opened. *1</li> <li> Appendix 3 Using Existing Data</li> <li>• GOT1000 Binary Files (*.G1); The project data for GOT-1000 series saved in binary format will be opened. This binary format file is the project data equivalent to the *.GTE file of GT Designer2. Select this file format mainly when opening the project data copied in the CF card using the utility function of the GOT.</li> <li>• F900GOT Binary Files (*.FI) (Only GOT-F900 series); The project data for the data transfer tool will be opened.</li> </ul>	○	○

\*1 For details of the project data conversion from GOT-F900 (\*.DUP) to GT11, refer to Project Data Conversion Summary.

## Point

### Data within a memory card

Do not directory edit the project data within a memory card, i.e., project data transferred from GT Designer2 to a memory card or uploaded from the GOT to a memory card, as these operations may cause the following problems:

- The data cannot be transferred to the GOT.
- The GOT cannot monitor correctly.

When editing the project data within a memory card, copy the data from the memory card to a PC, and then edit them.

## Remark

### (1) Using existing GOT data

- GOT800 series : The data are converted to the monitor screen data for the GOT-A900 series with the GT converter.
- A77GOT and 64GOT : The data are converted to the monitor data for the GOT-A800 series and then converted to the monitor screen data for the GOT-A900 series with the GT converter.

Refer to the following for conversion to the monitor screen data for the GOT-A900 series.

 GT Converter Version□ Operating Manual

### (2) Using existing DU (data access unit) data

- DU series: Select the DU-WIN file and open the project data.

The DU-WIN file is the project data prepared with the FX-PCS-DU/WIN drawing software.

Up to Ver. 1.01B, a temporary file is created in the some folder of DU-WIN file in reading.

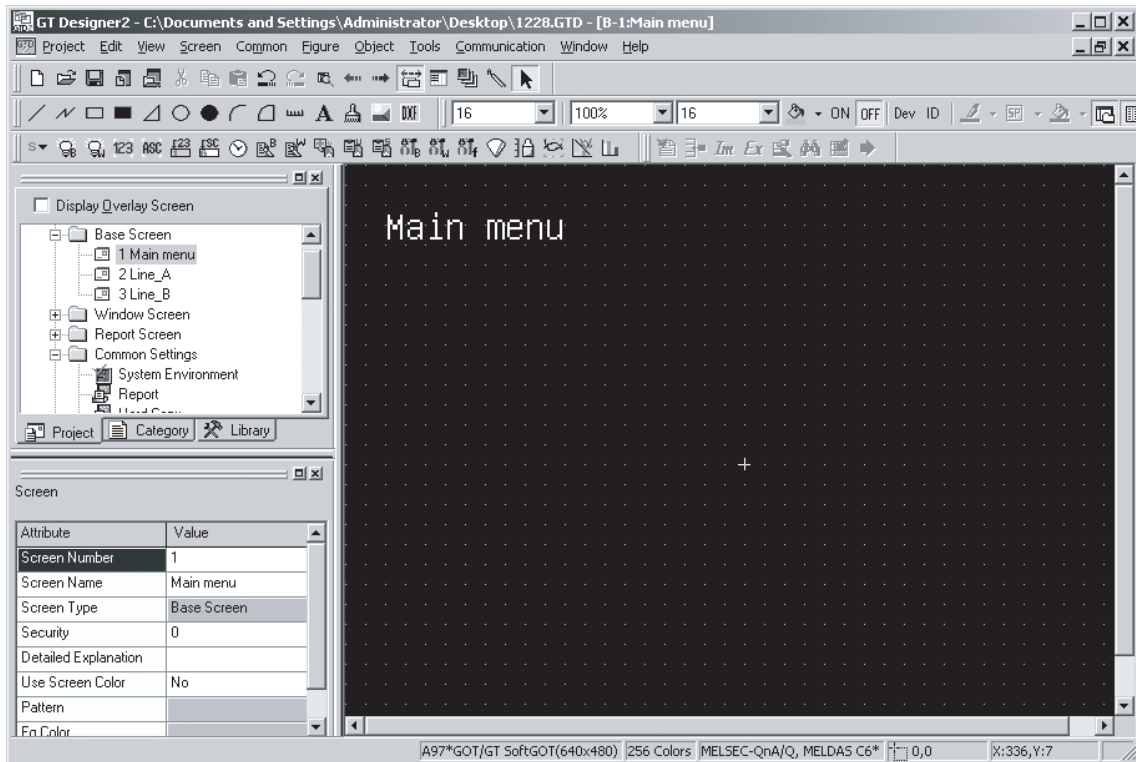
Accordingly, a write-enabled memory device (such as floppy disk and hard disk) should be set to the write-enabled status.

The read screen data is compatible because the menu name and data handling of the software DU-WIN are same.

- The base screen No. starts from No.0.
- The system information consists of control devices.

For the details, refer to the GOT-F900 SERIES OPERATION MANUAL (GT Designer2).

- 3 Click the Open button to open the specified project.



### Point

DU-WIN file cannot be converted to GOT data.

### Remark

Opening project directly

Double click the project data (\*.GTD). The GT Designer2 starts with the project data open.

## 4.3.2 Closing project

---

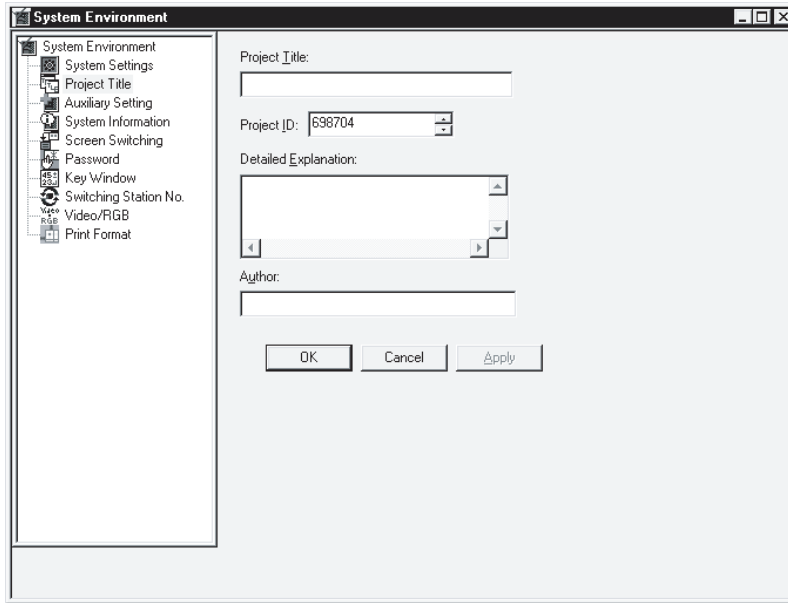
Close the open project.

- 1 Select [Project] → [Close] menu.
- 2 The open project data is closed.

## 4.4 Setting the Project Title

Set the details of the project (project ID, detailed explanation, author, etc.).

- 1 Choose the [Common] → [System Environment] menu.
- 2 Double-click [Project Title] under System Environment.
- 3 As the Project Title dialog box appears, set the following items and click the  button.



Item	Description	A	F
Project title	Set the project title as necessary. Up to 32 characters can be entered.	<input type="radio"/>	<input type="radio"/>
Project ID *1	The project ID can be set within the range of 1 to 4294967295 by the user, although it is automatically assigned when the project data is created.	<input type="radio"/>	<input type="radio"/>
Detailed Explanation	Enter the explanation for the project as necessary. Up to 512 characters can be entered. (A line feed is counted as two characters.)	<input type="radio"/>	<input type="radio"/>
Author	Set the author name as necessary. Up to 8 characters can be entered.	<input type="radio"/>	<input type="radio"/>

Refer to the following for details of \*1.

### \*1 Project ID

When a part of the screen in the project data is downloaded, the Project ID is verified with the one registered in the GOT. If it results in the ID mismatch, a message appears to urge the user to take caution.

It is recommended to register different Project IDs for different machines, as this allows the caution message to appear when a part of the project data with an incorrect ID is downloaded by mistake.


However, the project data can be downloaded even if the Project ID is incorrect.

## 4.5 Creating a New Screen

Base screen, window screen and report screen are newly created.  
Refer to the manual below for the preparation method of the report screen.

 GT Designer2 Version□ Reference Manual

1 Perform either of the following operations.

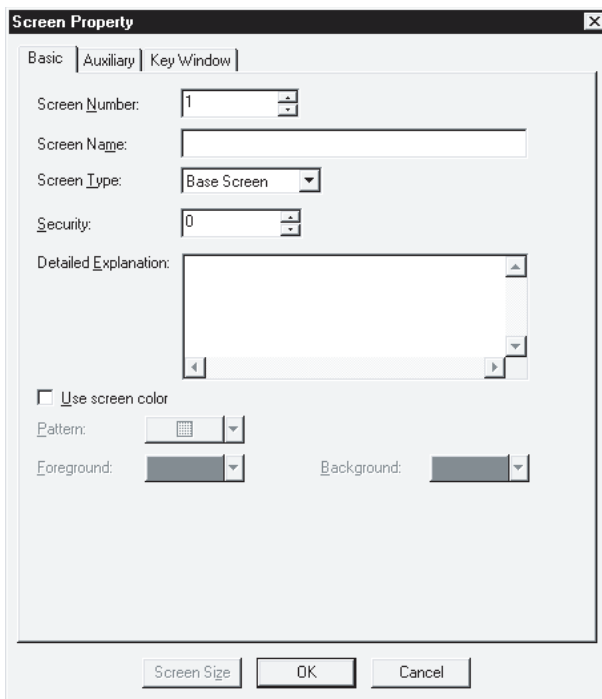
- Click  (New Screen).
- Select [Screen] → [New Screen] → [Base Screen]/[Window Screen] menu.

2 The screen property dialog box is displayed.

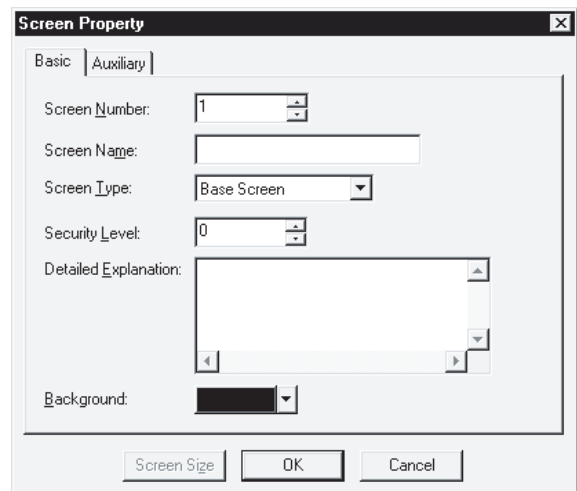
After setting the items below, click the **OK** button. The screen is created.

### ■ Basic tab

Screen number, name and type of the new screen are set.



(GOT-A900 series)



(GOT-F900 series)

Item	Description	A	F
Screen Number	Screen number is selected.	○	○
Screen Name	Screen name is input. Set the text within 32 characters. (If a line feed is used, it is considered as 2 characters.)	○	○
Screen Type	Screen type is selected. Base screen : Base screen is created. Window screen : Window screen is created.	○	○
Security	Security level (1 to 15) of each screen is set. When the security function is not used, set to "0." Refer to the manual below for details of the security function.	○	○

 GT Designer2 Version□ Reference Manual

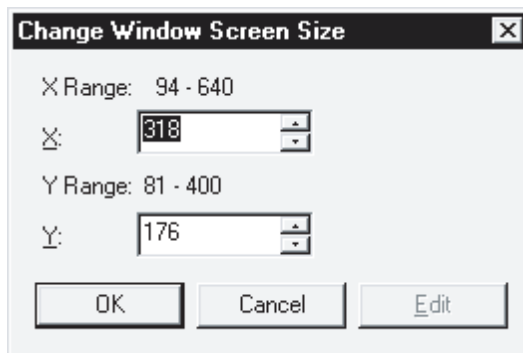


Item	Description	A	F
Detailed Explanation	Explanation of the new screen to be created is input as required. 512 characters can be input.	<input type="radio"/>	<input type="radio"/>
Use screen color	Color of the overall screen is set. Pattern type is displayed with filled color on the background.	<input type="radio"/>	<input checked="" type="radio"/>
	Pattern (Ex.) Background: <input type="checkbox"/>	<input type="radio"/>	<input checked="" type="radio"/>
	Foreground Pattern: <input checked="" type="checkbox"/>	<input type="radio"/>	<input checked="" type="radio"/>
	Background Foreground: <input type="checkbox"/>	<input type="radio"/>	<input checked="" type="radio"/>
Background	Color of the overall screen is set.	<input checked="" type="radio"/>	<input type="radio"/>
Screen Size *1	Size is displayed only for creation of the window screen. Size of the window screen is set.	<input type="radio"/>	<input checked="" type="radio"/>

Refer to the following for details of \*1.

**\*1 Screen size**

Set the following items to determine the window screen size.





Item	Description	A	F
X	Horizontal window screen size is set.	<input type="radio"/>	<input type="radio"/>
Y	Vertical window screen size is set.	<input type="radio"/>	<input type="radio"/>
Edit	A handle for size change is displayed on the screen. Move the cursor to the handle position and drag it to change the size. When the screen becomes the desired size, click it to determine the window screen size. This cannot be set when the screen is newly created. (This can be selected for editing after creation of the screen.)	<input type="radio"/>	<input type="radio"/>

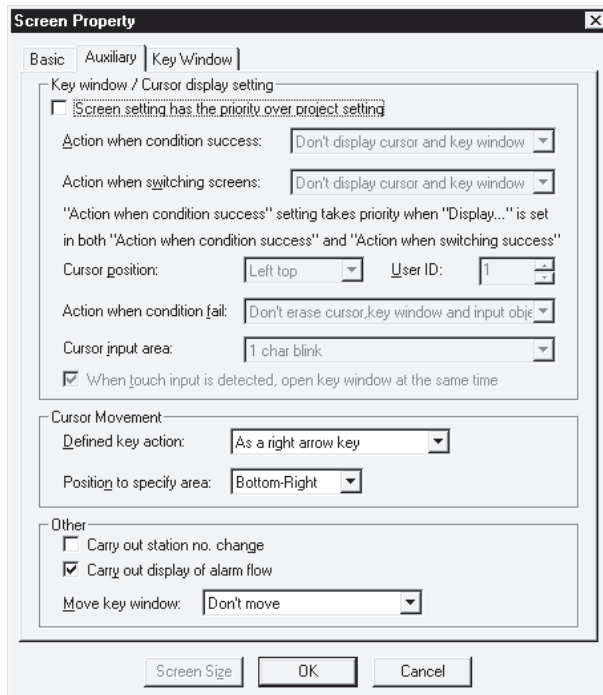
## ■ Auxiliary setting tab

Settings of the cursor, key window or data input for the screen which is newly created, and use/non-use of some object functions are specified.

Settings here can be changed after creation of the screen.

Refer to the manual below for details of the settings.

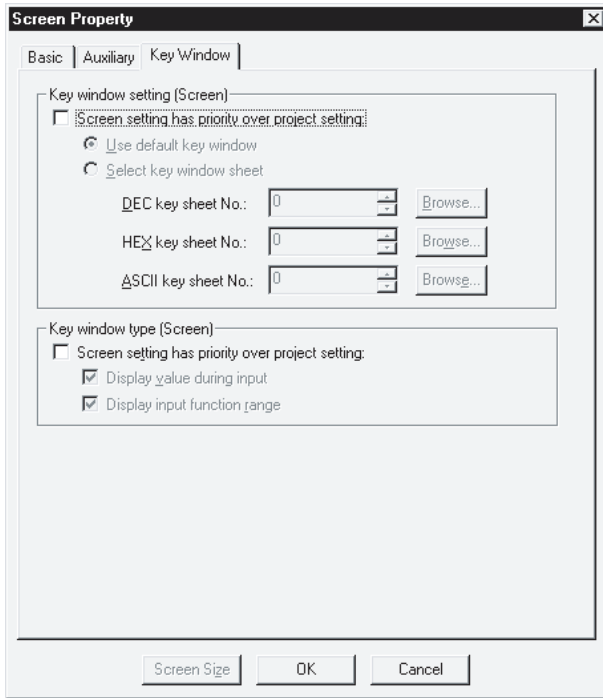
 GT Designer2 Version  Reference Manual



## ■ Key window tab

The key window which is used on the new screen is set. Settings here can be changed after creation of the screen. Refer to the manual below for details of the settings.

 GT Designer2 Version□ Reference Manual



## 4.6 Opening/Closing Screen

---

### 4.6.1 Opening screen

---

Screen data are imported on the currently editing project.  
The procedures are as follows:



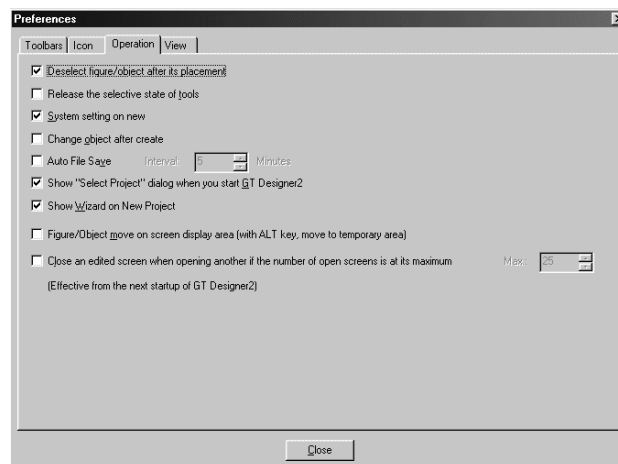
Number of screens that can be opened at a time

Maximum 25 screens can be opened.

When changing the maximum number of screens that can be opened at a time, set as follows.

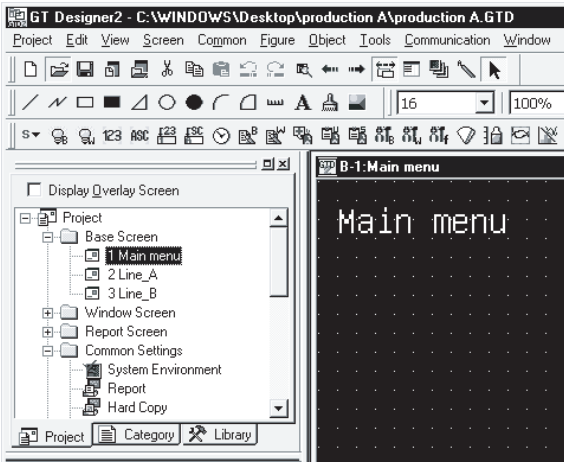
Changed number of screens will be enabled at the next startup.

- 1 Select the [Project] → [Preferences...] operation tab.
- 2 Check the "Close an edited screen when opening another if the number of open screens is at its maximum (Effective from the next startup of GT Designer2)" box on the operation tab in the Preferences dialog box.

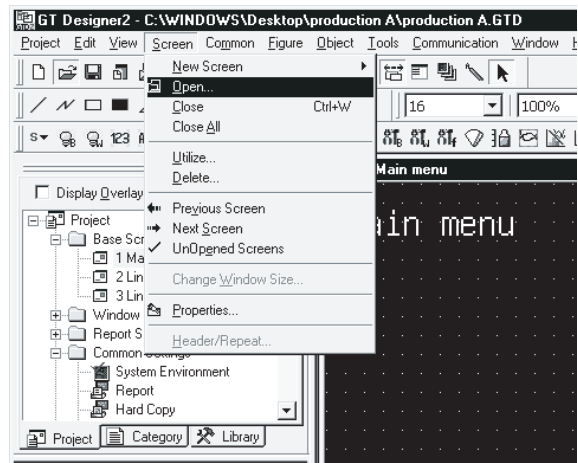


- 3 Click the  button.

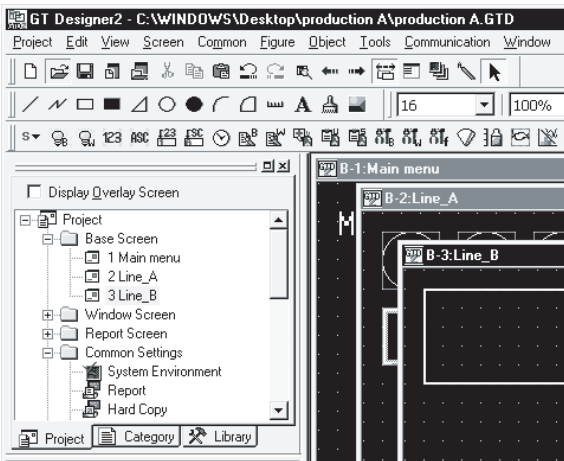
- (1) Open the screen from the workspace.  
(Operation details are described on the following pages.)



- (2) Open the screen from the menu.  
(Operation details are described in Hint on the following pages.)

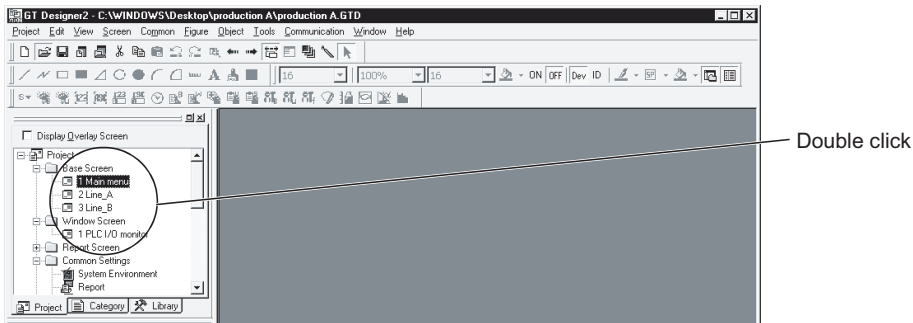


- (3) Open the screen continuously.  
Operation details are described in Hint on the following pages.)

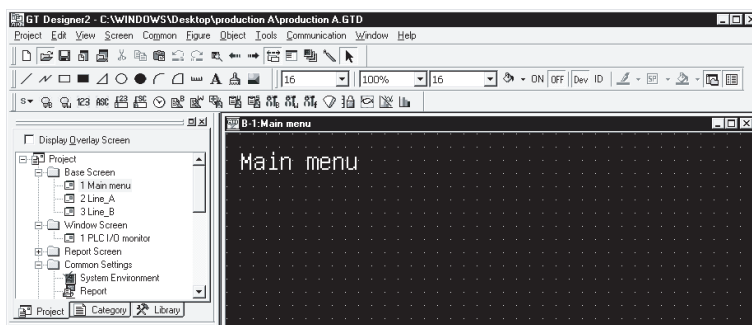


In this section, the method of opening the screen from the workspace in (1) is described.

- 4 Double click the desired screen for opening in the project workspace.



- 5 The screen opens.




**Hint!**


Method of opening other than workspace

- (1) Opening screen from menu

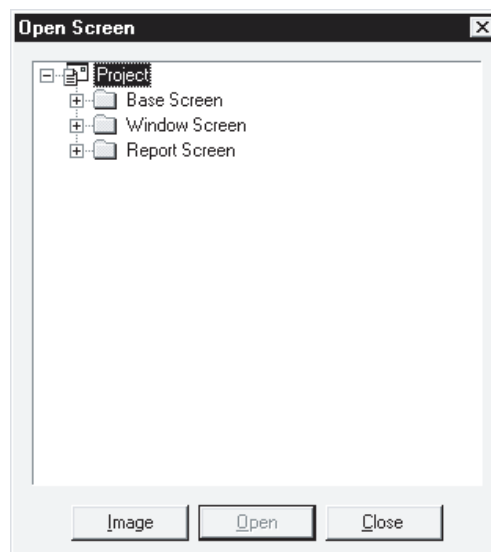
- 1 Perform either of the following operations.

- Click  (Open) of toolbars (Standard).
- Select [Screen] → [Open] from the menu.

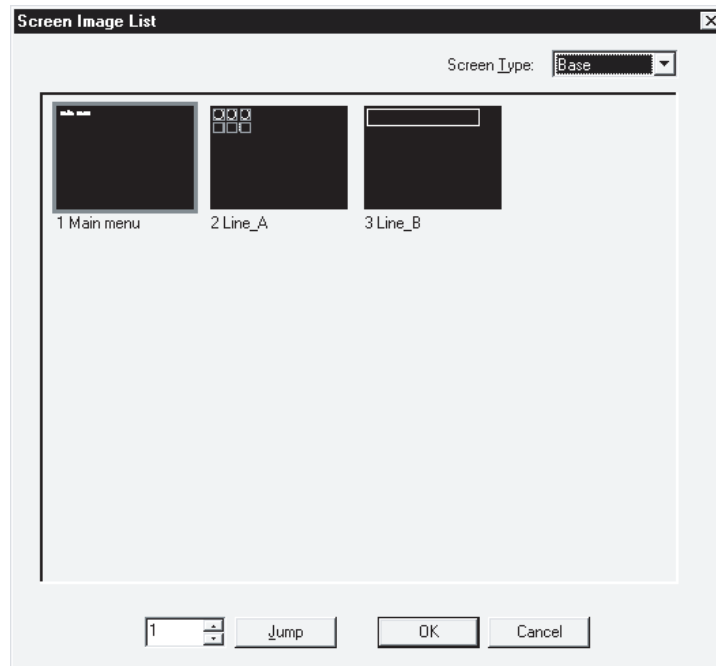
- 2 The dialog box to open the screen is displayed.

Click the  button.

(Double click the desired screen directly for opening.)



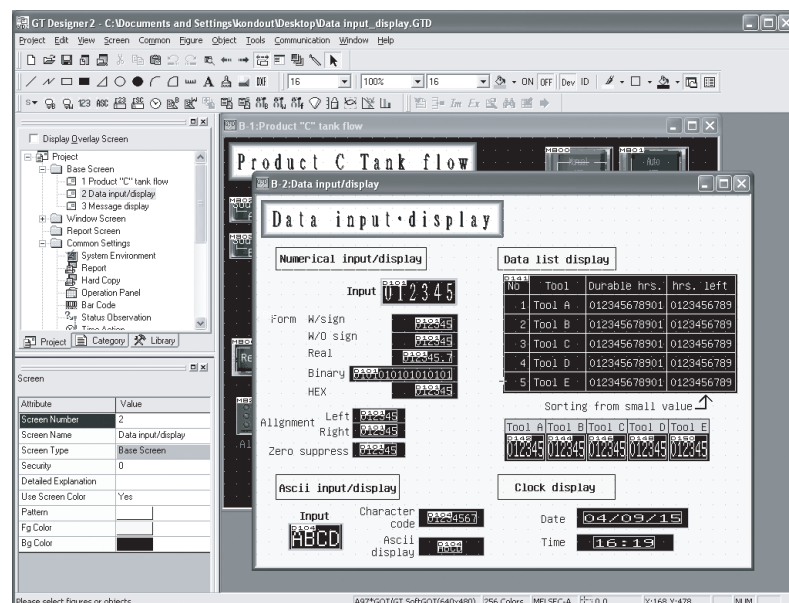
- The screen image view dialog box is displayed.  
Double click the desired screen.







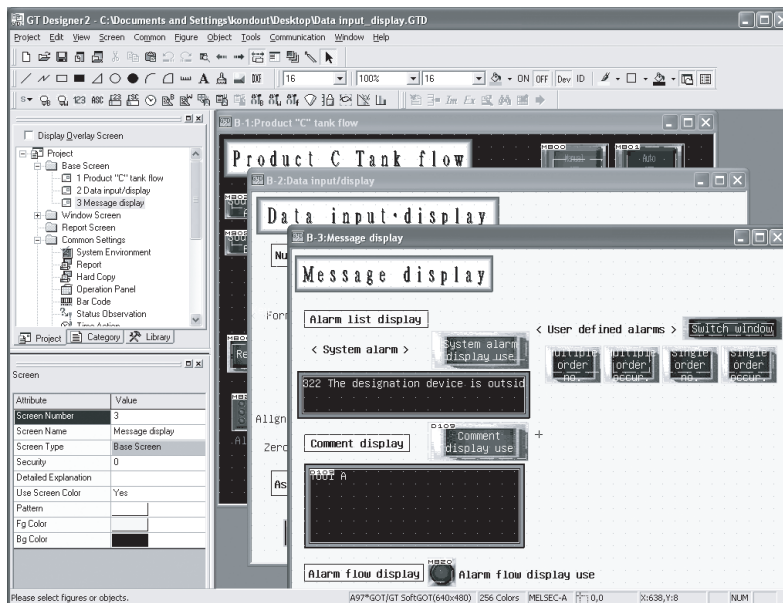
Item	Description	A	F
Screen Type	Screen type for opening is selected. Base screen : Base screen is displayed. Window screen : Window screen is displayed. Report screen : Report screen is displayed.	<input type="radio"/>	<input type="radio"/>
Screen display list	Screen image is displayed in a list. Double click each screen to open the screen.	<input type="radio"/>	<input type="radio"/>
Jump	The screen number is selected to open the screen.	<input type="radio"/>	<input type="radio"/>

## (2) Opening screen continuously

- Select the drawing screen of the desired type (base screen/window screen) for continuous opening and make the screen active.




- 2 Click  of the toolbars and keep the button depressed (  ).
- 3 Click the   button to open the same type screen of the active screen.



## 4.6.2 Closing screen

The open screen is closed.

- 1 Perform either of the following operations.
  - Select [Screen] → [Close] from the menu.
  - Click  on the title bar of each screen.
- 2 The open screen is closed.



**Hint!**

Closing all screens.

Select [Screen] → [Close All] from the menu to close all open screens.



# 4.7 Basic Operations of Drawing Screen (Editor)

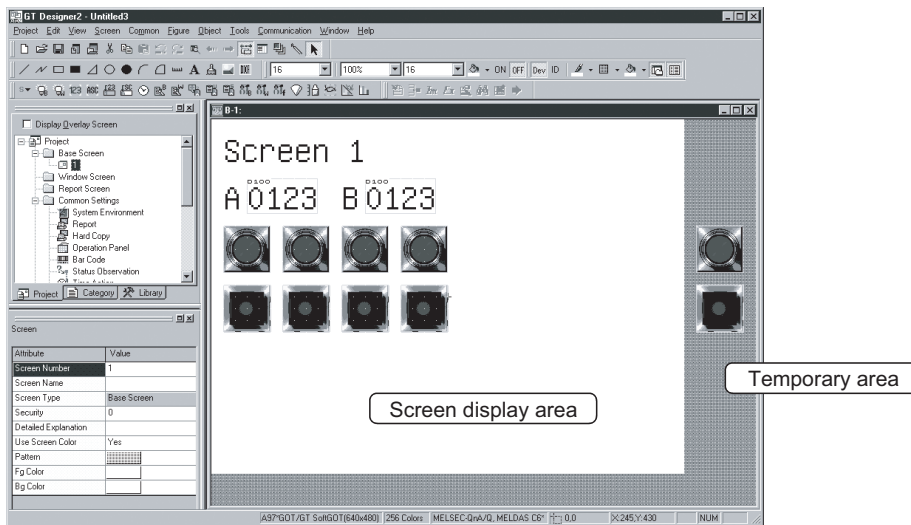
This section explains the basic operations on the drawing screen (editor). For details of figures and objects, refer to the following section or manual.

👉 Figures: Chapter 8 DRAW AND EDIT

👉 Objects: GT Designer2 Version□ Reference Manual

## 4.7.1 Object placement area and display area on GOT

The drawing screen editor for base screen and window screen provides two areas: screen display area and temporary area. The temporary area is the area for temporary placement of objects and figures during screen layout change. This feature enables the screen layout to be smoothly changed.



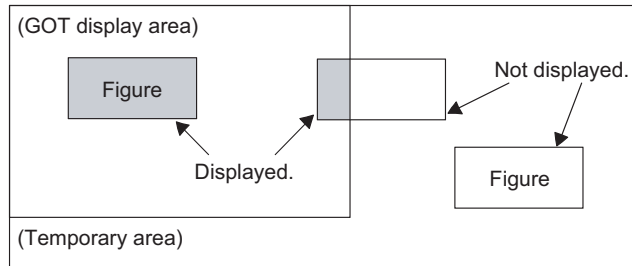
Item	Description
Screen display area	Area displayed on the GOT.
Temporary area	Not displayed on the GOT. In this area, however, figures and objects can be placed during screen creation.

**Figures or objects placed on the area boundary**

When placed on a boundary between the GOT display area and temporary area, figures or objects will be handled as described below.

• **Figures**

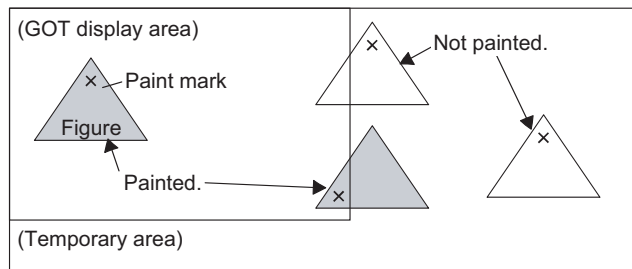
The all figures inside the GOT display area will be displayed.



• **Paints**

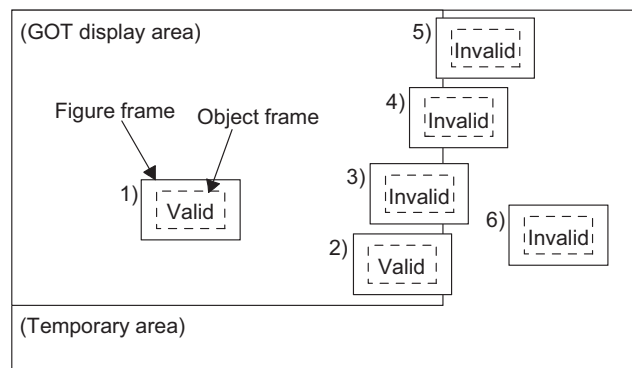
When paint marks ("X" shown below) are placed in the temporary area, the marked figures will not be painted.

F900 series does not provide a paint function.



• **Objects**

The object is displayed if its entire object frame is inside the GOT display area (1, 2), but not displayed if any part of its object frame is outside the GOT display area (3, 4, 5, 6). F900 does not transfer the figures or objects to the F900 main unit if they are placed on the temporary area.



## 4.7.2 Basic operations for object placement

This section explains object placement.  
Refer to the following manual for object setting.

 GT Designer2 Version□ Reference Manual

### 1 Placing figures and objects

A series of operations for placing figures and are provided here.

#### 1 Perform either of the following operations.

- From the [Object] menu, select the object to be placed.

Example) Bit switch object

Choose [Object] → [Switch] → [Bit Switch].

The cursor changes to + (placement mode).

- On the object toolbar, click the object to be placed.

Example) Bit switch object

Click  on the Object toolbar, and click  [Bit Switch] from among the submenu items.

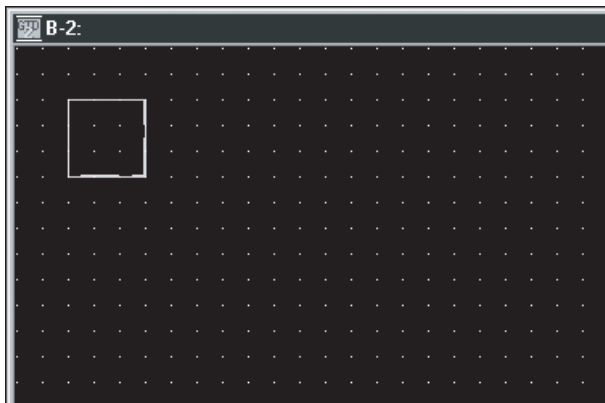
The mouse cursor changes to + (placement mode).



#### 2 Move the cursor to the desired position, and click the mouse to place the object.

Objects of the same type can be placed consecutively by clicking the mouse repeatedly.

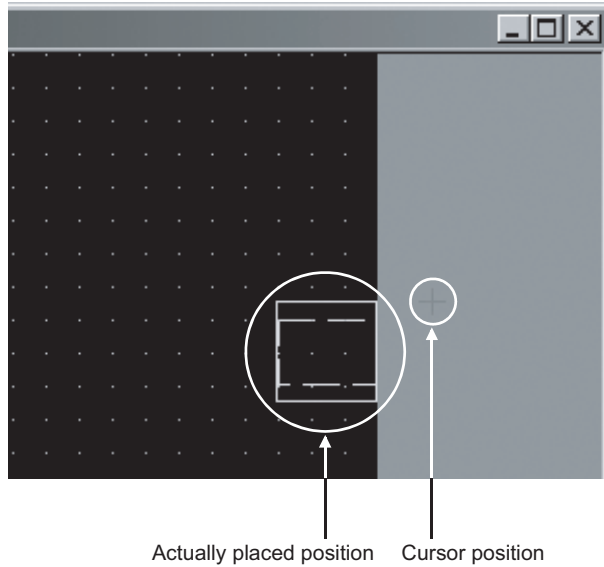
When stopping this operation, right-click the mouse after placing the object to release the cursor from the placement mode.



Placing and moving a figure or object

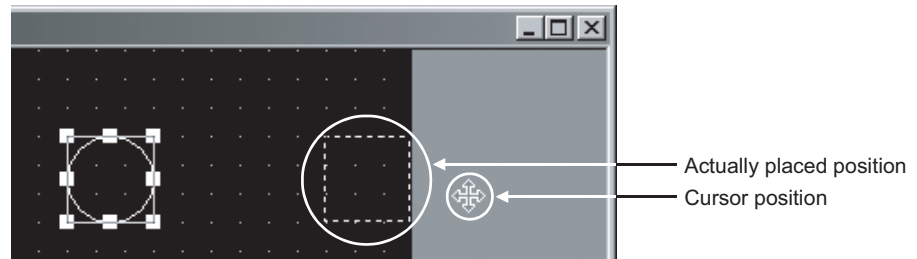
(1) When placing a figure or object

Performing the operation with the **Alt** key held down places the figure or object inside the screen display area. Even if an attempt is made to place in the temporary area, the target will be placed at the right or bottom end of the screen display area.



(2) When moving a figure or object

Performing the operation with the **Alt** key held down moves and places the figure or object inside the screen display area.




## 4.7.3 Figure drawing/text input


The following explains how to draw a frame line and text.

### 1 How to draw a frame line

An example of drawing a rectangle is provided here.

Refer to the following section for details of figure drawing and text input.

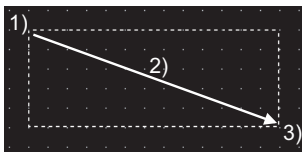
 Section 8.1.1 Drawing figures

- 1 Click  "Rectangle" on the Figure toolbar.  
The mouse cursor changes to +.



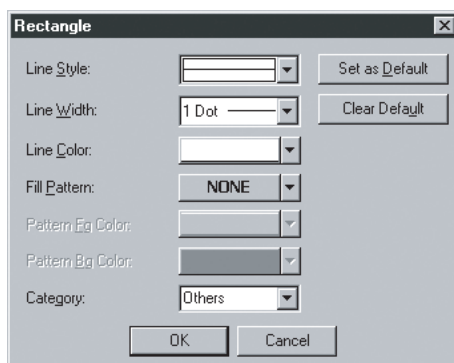
- 2 Draw a rectangle.

- (1) Left-click at the starting point. (1) below
- (2) Drag the mouse to move the cursor to the end point. (2) below
- (3) Releasing the left button of the mouse draws a rectangle. (3) below  
(Then, right-click the mouse to exit from the placement mode.)



- 3 Set the frame line and paint of the rectangle.

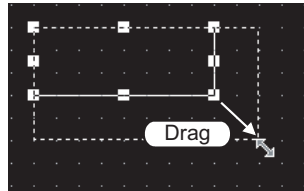
- (1) Double-click the created rectangle.  
The Setting dialog box appears.
- (2) Change the color and thickness of the line.
- (3) Clicking the  button determines the settings and closes the dialog box.  
Click the  button to cancel the settings and close the dialog box.





## Changing the figure


Select the figure to be resized and then drag the handle ( ) to change its size.  
(Example) When resizing a rectangle



## 2 How to draw a text

This section explains how to draw a figure text briefly.

Refer to the following section for detailed explanation of figure drawing and text entry.

 Section 8.1.2 Entering text

### 1 Click **A** "Text" on the Figure toolbar.

The mouse cursor changes to +.

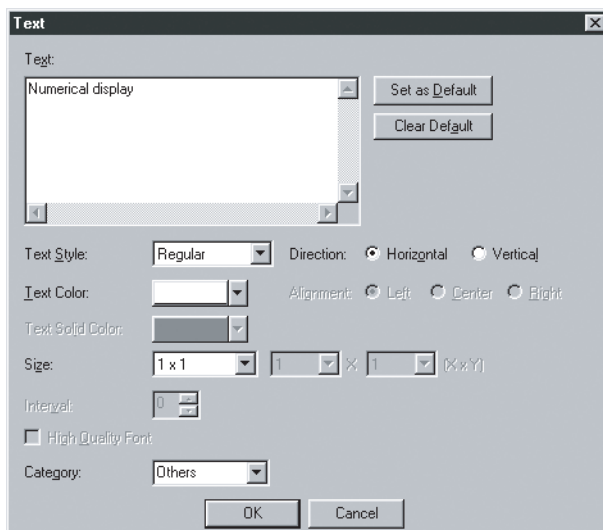


### 2 Enter a text.

(1) When the mouse cursor changes to +, click the mouse on the text drawing position.

(2) When the Text/Figure dialog box appears, input a text.  
The input will be immediately reflected on the screen.

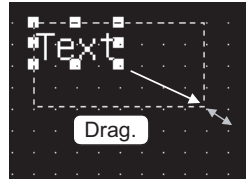
(3) Click the **OK** button to close the dialog box.






### Changing the text size

Select the text to be resized and then drag the handle (■) to change its size. The size can also be changed in the above dialog. (Example) When resizing a text



## 4.7.4 Object function setting


This section provides a series of operations for setting the following object functions. Refer to the following manual for object details.

 GT Designer2 Version□ Reference Manual

- "Numerical Display" object
- "Bit Lamp" object
- "Bit Switch" object

### 1 Setting the "Numerical Display" object

A series of operations for setting the "Numerical Display" object is briefly explained here.

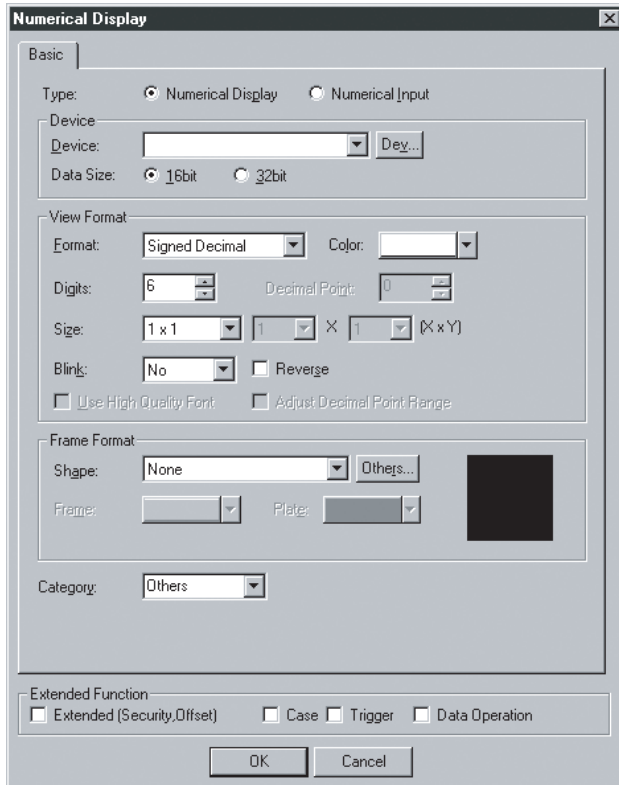
- 1 Click  "Numerical Display" on the Object toolbar. The mouse cursor changes to +.



- 2 Click the mouse on the desired position to place the object. (Then, right-click the mouse to exit from the placement mode.)



- 3 Set the "Numerical Display" object.
  - (1) Double-click the placed "Numerical Display" object.  
The dialog box appears.
  - (2) Set the Type, View Format, Frame Format, etc.
  - (3) Then, click the  button.



"GT Designer2 Version□ Reference Manual" for details of objects



Section 4.7.5 Basic operations of dialog box



### Changing the object size

Select the object to be resized and then drag the handle (■) to change its size.

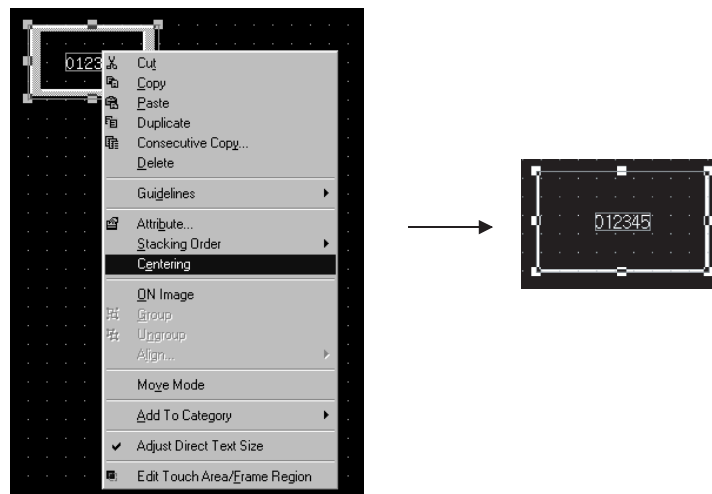


When the object size is changed, this may result in misalignment between the figure frame and the object as shown below.



In this case, perform the following operation.

- 1 Select the object.
- 2 Right-click the mouse and select [Centering].  
This will automatically correct the misalignment.




### Edit Touch Area/Frame Region

By selecting [Edit Touch Area/Frame Region], the figure frame and object can be moved separately.

## 2 Setting the "Lamp [Bit Lamp]" object

A series of operations for setting the "Lamp [Bit Lamp]" object is briefly explained here.

- 1 Click  "Bit Lamp" on the Object toolbar.

The mouse cursor changes to +.

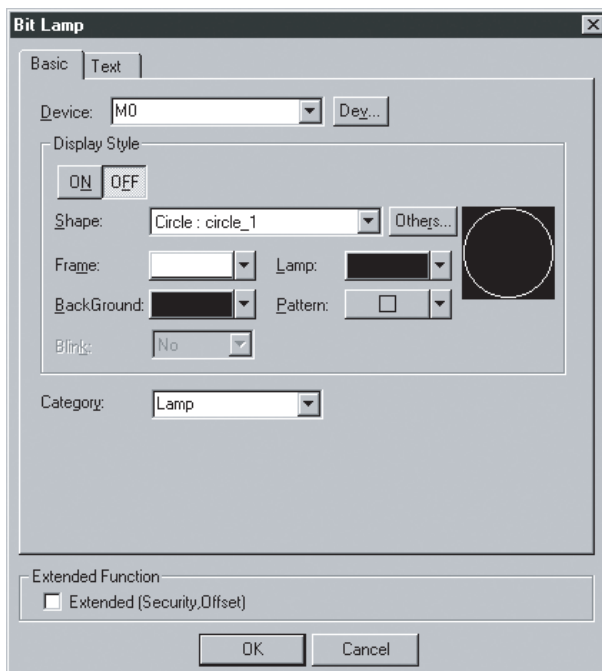


- 2 Click the mouse on the desired position to place the object.  
(Then, right-click the mouse to exit from the placement mode.)



- 3 Set the "Lamp [Bit Lamp]" object.

- (1) Double-click the placed "Lamp [Bit Lamp]" object.  
The dialog box appears.
- (2) Set the Device, View Format, etc. in the Basic tab.



"GT Designer2 Version□  
Reference Manual" for details  
of objects



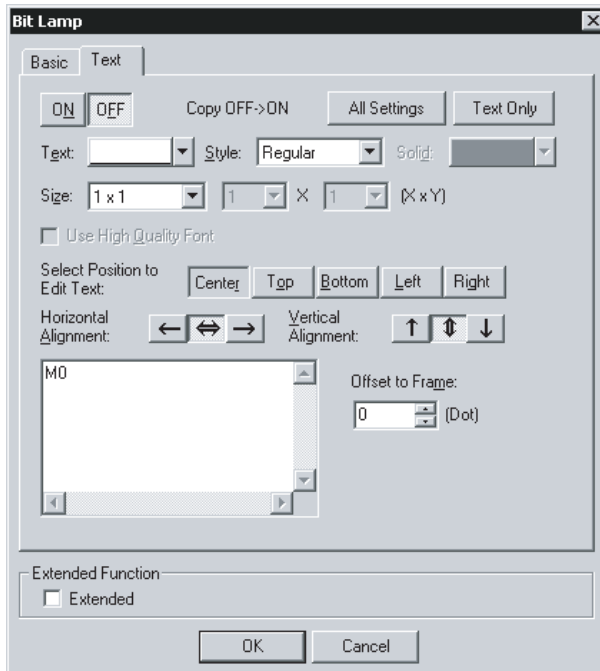
Section 4.7.5 Basic operations  
of dialog box

- (3) Set the text color, text size, etc.  
The settings of "ON Display" and "OFF Display" can be made in the Text tab, and both settings are required.

Click the **ON** button to set the ON status display, and the **OFF** button to set the OFF status display.

Register a text for each display position (Center, Top, Bottom, Left, Right).

The display position button turns red-purple (magenta) when the corresponding text is entered.



→ "GT Designer2 Version□ Reference Manual" for details of objects

→ Section 4.7.5 Basic operations of dialog box

- (4) Then, click the **OK** button.



**Hint!**

Making the ON Display and OFF Display the same

To set the ON display the same as the OFF display, after setting the character tab ON or OFF, click the **All Settings** or **Text Only** button at **Copy ON -> OFF** or **Copy OFF -> ON** button.

**All Settings** button: Copy characters, Character formats, character sizes, and display positions.

**Text Only** button: Copy only text.

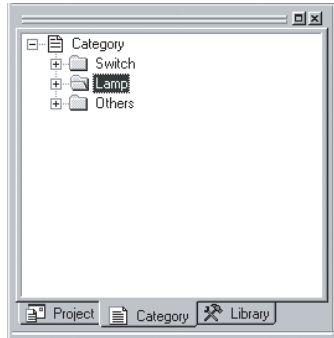


## Hint!

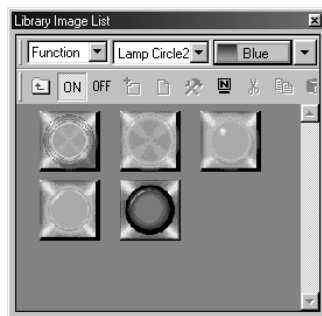
Placing the "Lamp" or "Switch" objects with figures from the library

Lamps or switches with figures can also be placed from the system library by drag-and-drop.

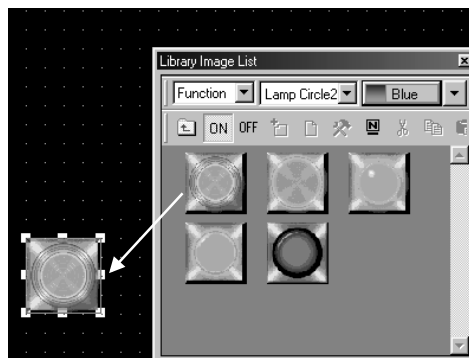
- 1 Click the Library tab in the workspace.  
The workspace display changes to the Library workspace.



- 2 Double-click the "Lamp Circle 256 (1)" or "Switch Circle 256 (1)" folder in the "Lamp" folder.  
The "System Library" window appears.




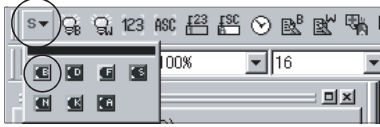
- 3 Click the target lamp or switch object in the "System Library" window, and drag and drop it on the desired position.



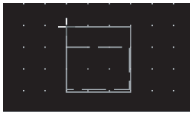
### 3 Setting the "Touch Switch [Bit Switch]" object

A series of operations for setting the "Touch Switch [Bit Switch]" object is briefly explained here.

- 1 Click  on the Object toolbar, and click  "Bit Switch" from among the submenu items. The mouse cursor changes to +.

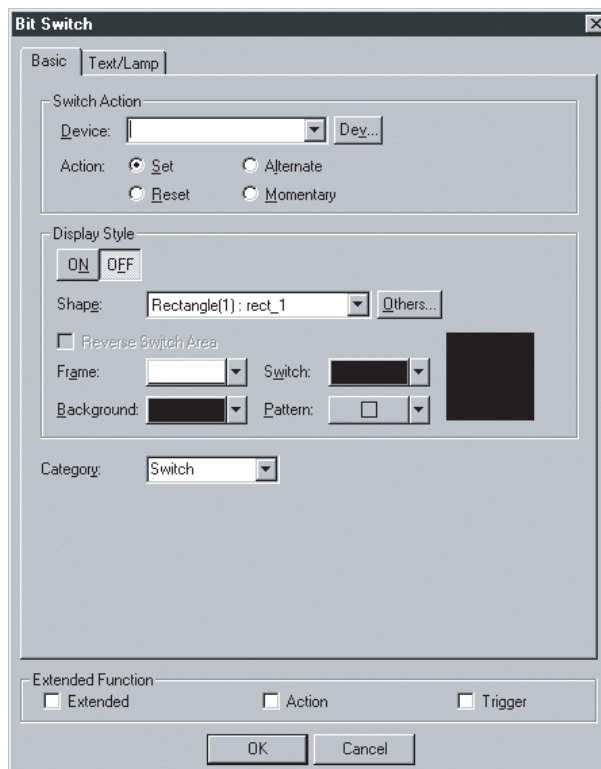



- 2 Click the mouse on the desired position to place the object. (Then, right-click the mouse to exit from the placement mode.)




- 3 Set the "Touch Switch [Bit Switch]" object.

- (1) Double-clicking the placed "Touch Switch [Bit Switch]" object displays the dialog box.
- (2) Set the Switch Action, Display Style, etc. in the Basic tab.



 "GT Designer2 Version□ Reference Manual" for details of objects

 Section 4.7.5 Basic operations of dialog box

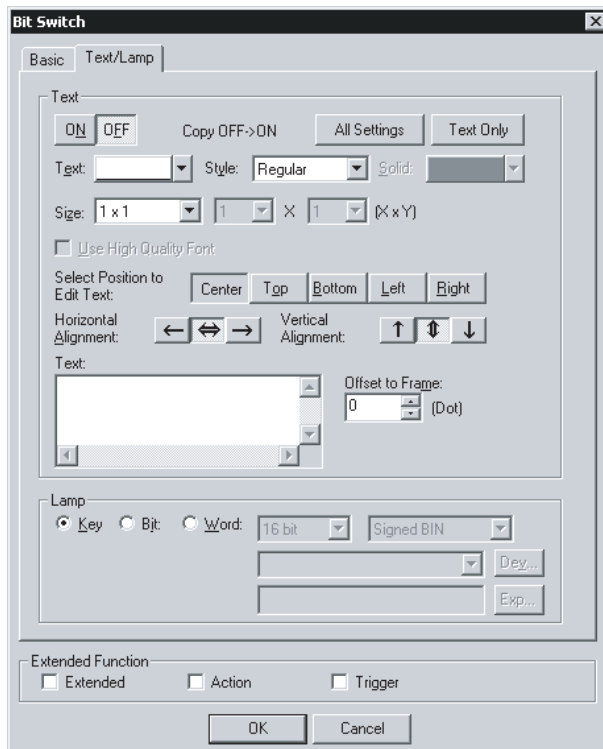
(3) Set the text, lamp function, etc. in the Text/Lamp tab.


The settings of "ON Display" and "OFF Display" can be made in the Text tab, and both settings are required.


Click the  button to set the ON status display, and click the  button to set the OFF status display.

Register a text for each display position (Center, Top, Bottom, Left, Right).

The display position button turns red-purple (magenta) when the corresponding text is entered.



 "GT Designer2 Version□ Reference Manual" for details of objects

 Section 4.7.5 Basic operations of dialog box

(4) Then, click the  button.



Making the ON Display and OFF Display the same

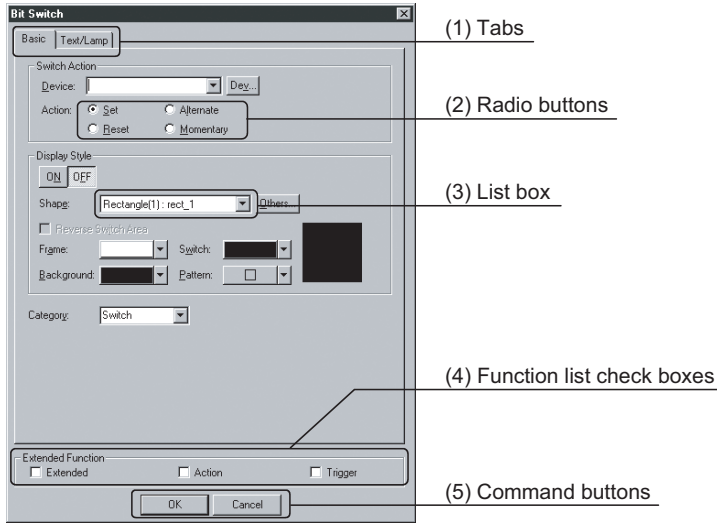
To set the ON display the same as the OFF display, after setting the character tab ON or OFF, click the  or  button at  or  button.


button: Copy characters, Character formats, character sizes, and display positions.

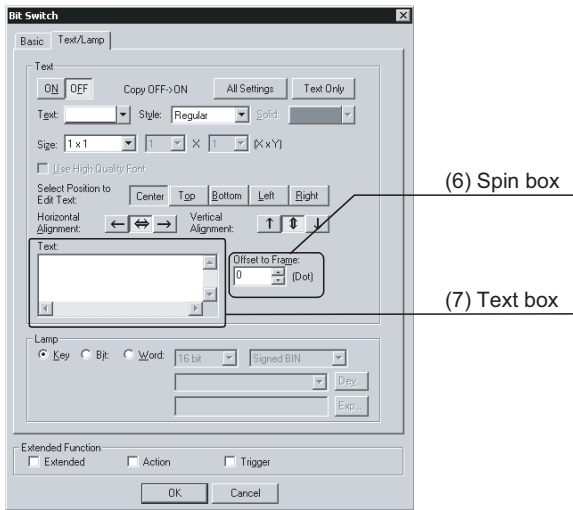
button: Copy only text.


## 4.7.5 Basic operations of dialog box

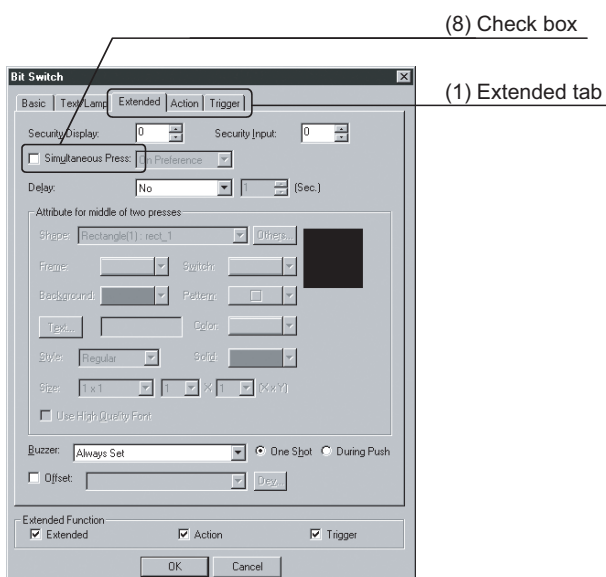
This section explains the basic operations of the dialog box.




- (1) Tab  
Click  to switch from one tab to the other.  
Checking the Function list check box additionally displays the corresponding extended tab. On the extended tab, more details can be set than on the basic tab.

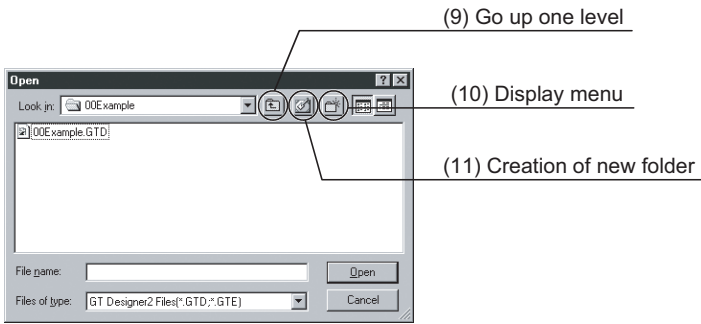


- (2) Radio button  
Select an item by clicking the corresponding .
- (3) List box  
Click  to display the selection list, and click and select an item.



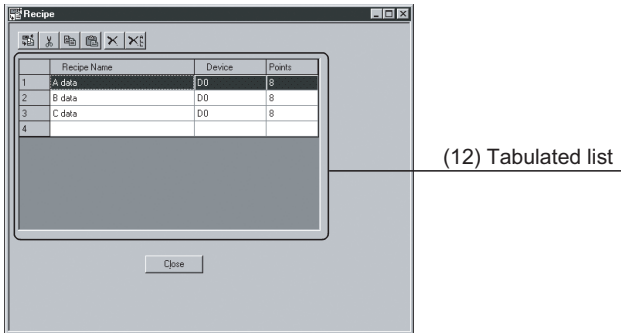
- (4) Function list check box  
When displaying the extended tabs, click to put a check mark. The settings made on the extended tabs are valid if this check box is unchecked and the tabs are hidden.
- (5) Command button  
The command buttons such as  and  are provided. Click the command button to execute the corresponding item.

- (6) Spin box  
Enter a value directly, or change the numerical value by clicking .
- (7) Text box  
Enter a text from the keyboard.
- (8) Check box  
When executing the item, click to put a check mark.



(9) Go up one level  
Displays contents of the directory above the current directory.

(10) Display menu  
Provides the viewing mode of the folders and files in the current folder; select from detailed display, list display and other modes.

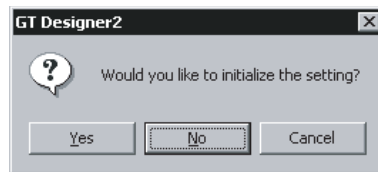


(11) Creation of new folder  
Creates a new folder.

(12) Tabulated list  
Select an item by clicking the corresponding leftmost field.



If the Extended Function check box in the object setting dialog is unchecked, the following message is displayed.



Item	Description	A	F
<b>YES</b>	Initialize all unchecked function settings and hide the initialize page.	<input type="radio"/>	<input type="radio"/>
<b>No</b>	Leave all unchecked function settings as-is and hide the initialize page.	<input type="radio"/>	<input type="radio"/>
<b>Cancel</b>	Close the message without making changes, and do not hide the page.	<input type="radio"/>	<input type="radio"/>



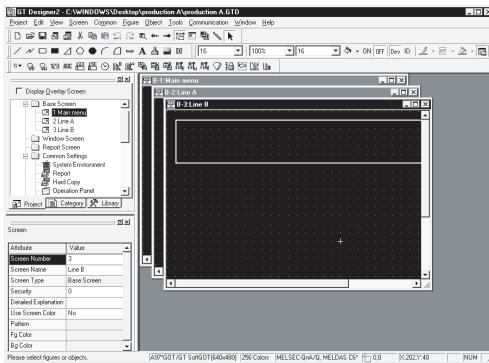
# 4.8 Operating Multiple Screens

## 4.8.1 Cascading/tiling screens

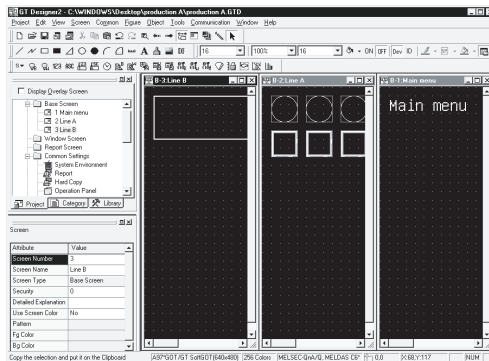
Multiple screens in the project are reordered.

- 1 Select [Window] → [Cascade]/[Tile Vertical]/[Tile Horizontal].
- 2 Multiple open screens are reordered as follows:  
(Ex.)

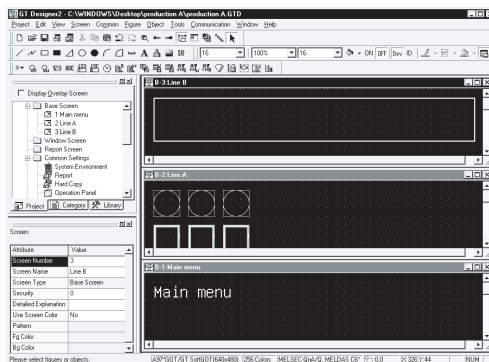
- Cascade  
Overlapped screens are displayed toward the lower right like a staircase.



- Tile vertical  
Screens are displayed as follows without overlapping.



- Tile horizontal  
Screens are displayed as follows without overlapping.

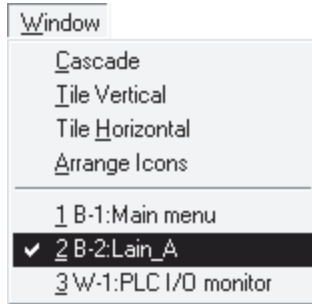


## 4.8.2 Making editing screen active

To edit a screen while multiple screens are displayed, make the edit screen active with either of the methods below:

- 1 Select the screen name from the [Window] menu.

(Ex.)



W-1: Key window switch

Screen name

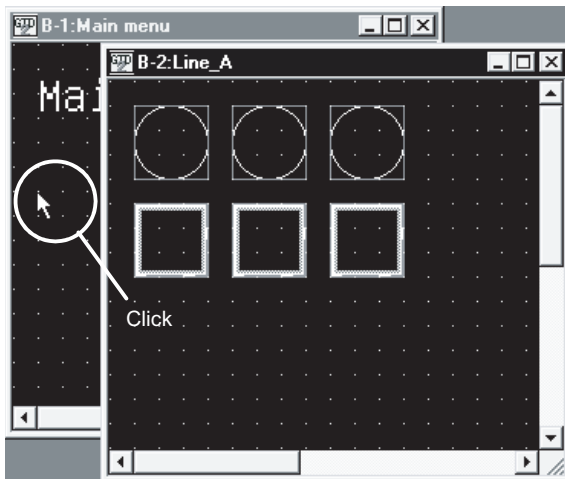
Screen type and number

(B: Base screen, W: Window screen, R: Report screen)

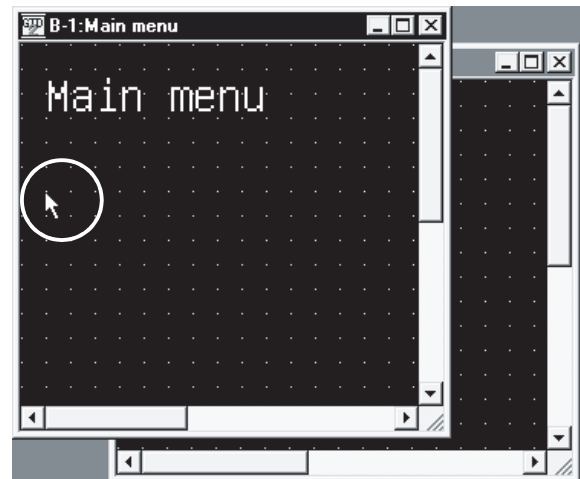
- 2 Click on a part of the screen.

Click on a part of the screen to make it active.

(Ex.)





Click on a part of the left window.



The left window is displayed at the front.

### Remark

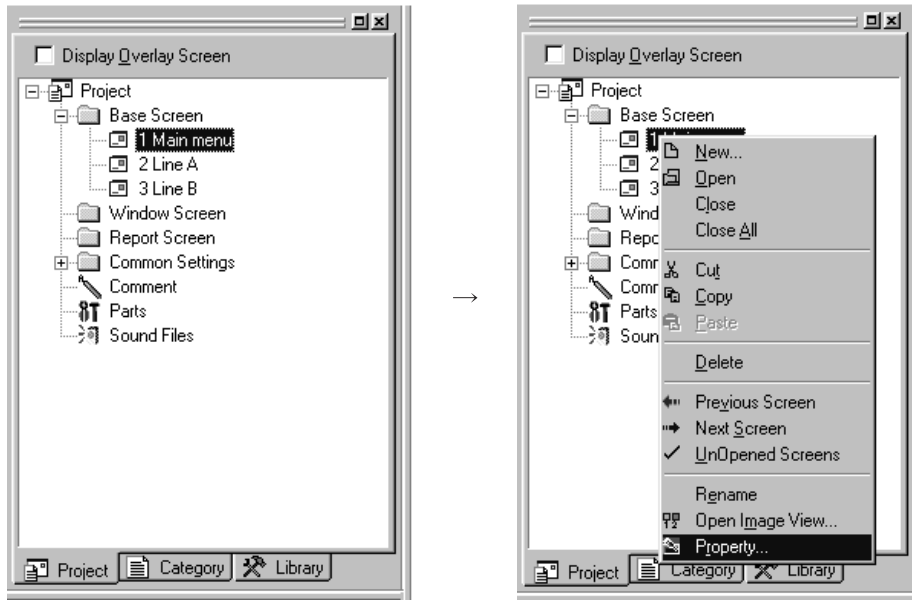
Activating method with   of toolbar

Click   of the toolbar to switch the active screen within a range of the same screen type (base/window screen/report screen).

## 4.9 Changing Screen Property

Screen settings such as screen number or home are changed.

- 1 Select the desired screen to change the property in the project workspace and select [Property] by right clicking on the mouse.

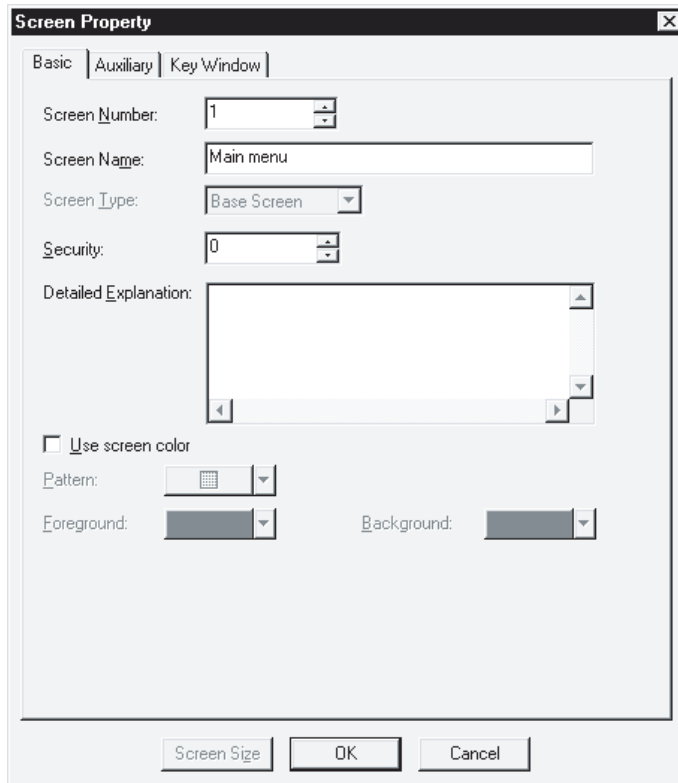


- 2 The screen property dialog box appears.  
Refer to the following for details of settings.

☞ Section 4.5 Creating a New Screen

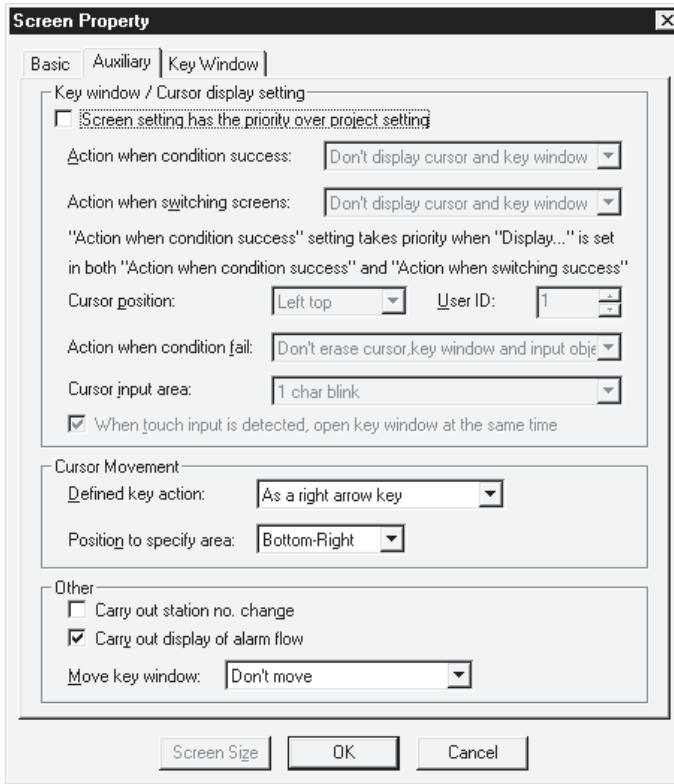
■ Basic tab

The screen number or name is changed.



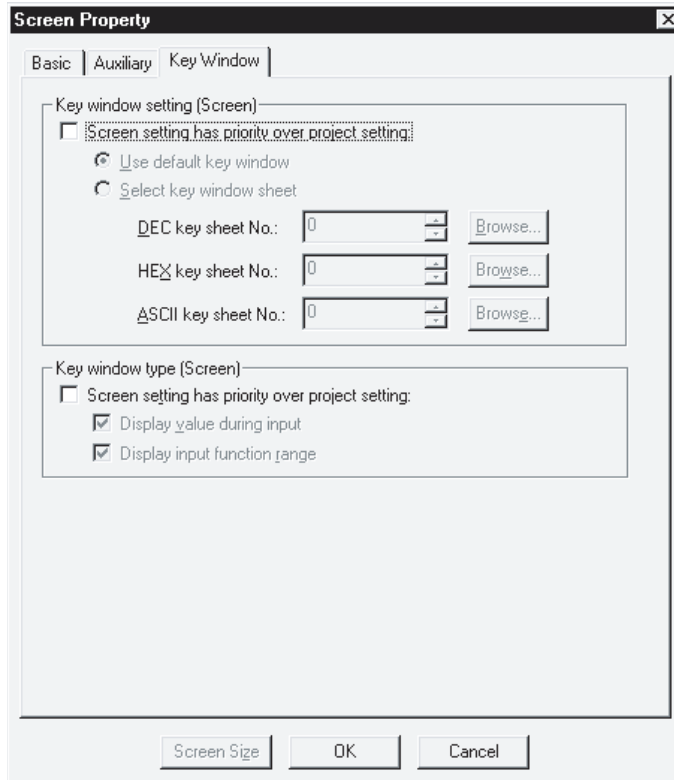
## ■ Auxiliary setting tab

Settings for data input operation and use/non-use of the object function are changed on the setting screen.



## ■ Key window tab

Settings for key window used on the setting screen are changed.





3 After changing settings of each tab, click the **OK** button.

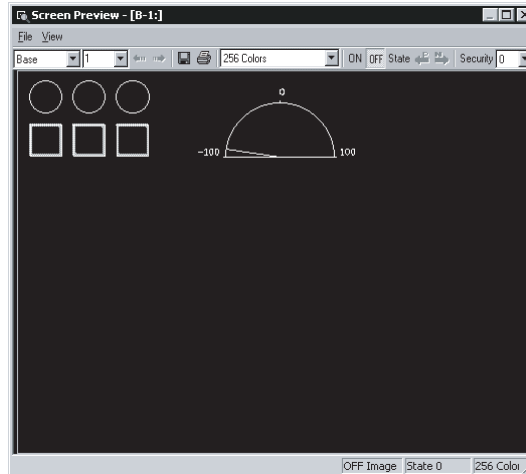
## 4.10 Viewing Created Screen Image

Image displayed on the GOT is checked.

### 4.10.1 Previewing the Base Screen

- 1 Perform either of the following operations.
  - Click .
  - Select [View] → [Preview] menu.
- 2 However, window display settings must be made in advance to preview the windowed screen. Refer to the following section for the operation.


 Section 4.10.2 Previewing the Base Screen with window



Item		Description	A	F
Screen		The preview screen to be displayed is selected.	<input type="radio"/>	<input type="radio"/>
File	Save	Preview display is saved in a file (BMP format file).	<input type="radio"/>	<input type="radio"/>
	Print	Preview display is printed.	<input type="radio"/>	<input type="radio"/>
	Printer Settings	Printer settings, paper and paper orientation are set.	<input type="radio"/>	<input type="radio"/>
	Output in reverse	Black and white is reversed when printing based on the printer/file setting.	<input type="radio"/>	<input type="radio"/>
	Fill Black at Text BG	Letters are filled in white and letter background is filled in black to make clearly visible reversed when printing based on the printer/file setting.	<input type="radio"/>	<input type="radio"/>
	Dithering	Intermediate color tone is provided on the two tone monochrome screen when printing based on the printer/file setting.	<input type="radio"/>	<input type="radio"/>
	Close	Preview screen is closed.	<input type="radio"/>	<input type="radio"/>
View	Menu and Title	Display/non-display of the title bar is selected.	<input type="radio"/>	<input type="radio"/>
	Toolbar	Display/non-display of the toolbars is selected.	<input type="radio"/>	<input type="radio"/>
	Status Bar	Display/non-display of the status bar is selected.	<input type="radio"/>	<input type="radio"/>
	Next Screen	The screen Number is changed to the setting for one screen below.	<input type="radio"/>	<input type="radio"/>
	Previous Screen	The screen Number is changed to the setting for one screen above.	<input type="radio"/>	<input type="radio"/>

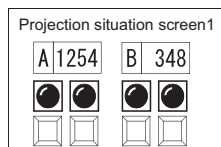
Item	Description	A	F
View	Use Preview No. [Checked] Display Word Comment and Word parts Display of the set Preview No. [Not checked] Display Word Comment and word parts Display according to the settings of each state.	<input type="radio"/>	×
	ON Image Every time the menu is selected, the preview screen display is switched to ON/OFF status. The display is the same as the ON/OFF display on the drawing screen. [When ON is selected] • Object with bit device set                      The shape or text set to ON is displayed. • Object with word device set                      The status set to state 1 is displayed. [When OFF is selected] • Object with bit device set                      The shape or text set to OFF is displayed. • Object with word device set                      The status set to state 0 (normal case) is displayed.	<input type="radio"/>	<input type="radio"/>
	Next State Screen display status set with the "State" in the object is switched in the ascending order.	<input type="radio"/>	×
	Previous State Screen display status set with the "State" in the object is switched in the descending order.	<input type="radio"/>	×
	Overlap 1 Select whether Overlap Window 1 will be displayed*1 or hidden.	<input type="radio"/>	×
	Overlap 2 Select whether Overlap Window 2 will be displayed*1 or hidden.	<input type="radio"/>	×
	Superimpose Select whether Superimpose will be displayed*1 or hidden.	<input type="radio"/>	×
	Key Window Select whether Key Window will be displayed*1 or hidden.	<input type="radio"/>	<input type="radio"/>
	2 Colors (EL)	<input type="radio"/>	×
	2 Colors (Blue Back)	×	<input type="radio"/>
	2 Colors (Monochrome) Screen colors to be displayed are set. Select the colors available for the GOT to be used.*2	<input type="radio"/>	<input type="radio"/>
	8 Colors	<input type="radio"/>	<input type="radio"/>
	16 Colors	<input type="radio"/>	×
	256 Colors	<input type="radio"/>	<input type="radio"/>
Security	Select the security level of the displayed object. Object with a number lower than the selected level are displayed.	<input type="radio"/>	×

\*1 To display a window in the preview window, the window must have been displayed in the Editor window of the Base Screen.

 Section 4.10.2 Previewing the Base Screen with window

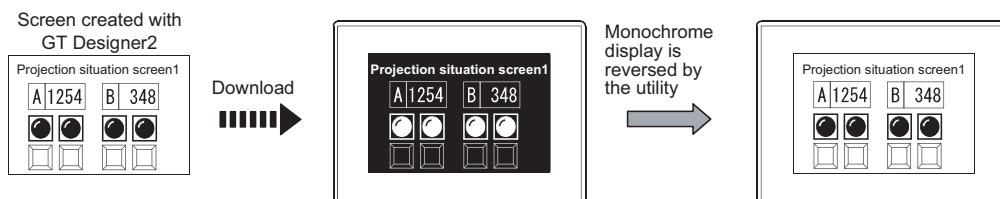
\*2 The image displayed by Preview will be displayed with reversed colors for monochrome type GOT.  
Draw screens considering the above. (The display on Preview and the actual GOT is different.)  
The created project data can be monochrome-reversed with the following method.

Example) Screen to be displayed on the GOT



(1) A95\*GOT (monochrome type)

The monochrome display can be reversed by the utility after downloading the project data to GOT.



(2) A970GOT (monochrome type)

Reverse the monochrome display with [Batch Edit] of GT Designer2 and then download the project data to GOT.



**Remark**

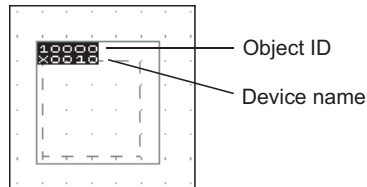
(1) Items displayed on preview

Items displayed on the preview (display/non-display of object, object ID, device name, etc.) can be changed with the settings of the GT Designer2.

☞ Section 3.4.3 Customizing GT Designer2 operating environment

(2) Display of object ID and device name

Object ID and device name are displayed on the preview screen. It is not displayed on the GOT.

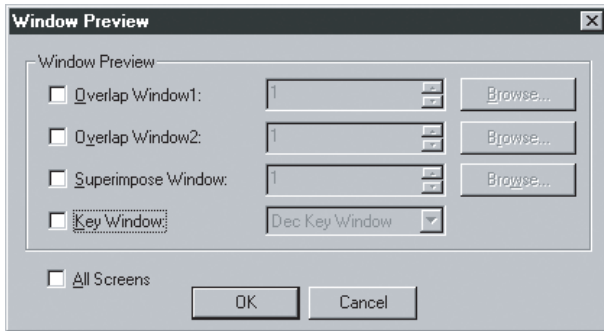




## 4.10.2 Previewing the Base Screen with window

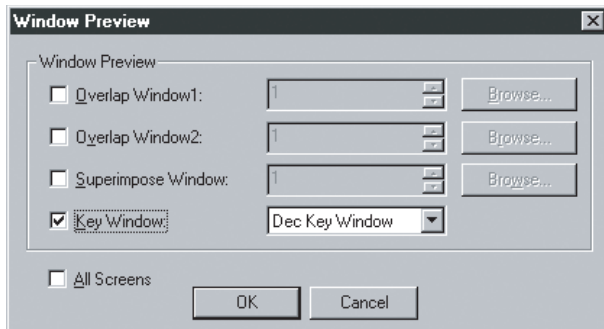
This section explains how to preview the image of the windowed screen that will be displayed on the GOT.

- 1 Choose [View] → [Window Preview] → [Custom...].
- 2 The Window Preview setting dialog box appears.



- 3 Put a check mark (✓) in the check box of the window to be displayed on the Base Screen. When displaying Overlap Window (1, 2) or Superimpose Window, click the **Browse...** button and select the window screen to be displayed.

Example) Make the following settings to display a Dec Key Window.



- 4 Click the **OK** button to display the windows set on the Base Screen.  
 To display the windows, however, the window display positions must have been set in advance. Choose the [Object] → [Window Position] menu, and set the display positions.  
 Refer to the following manual for the settings of the window display position.

☞ GT Designer2 Version□ Reference Manual



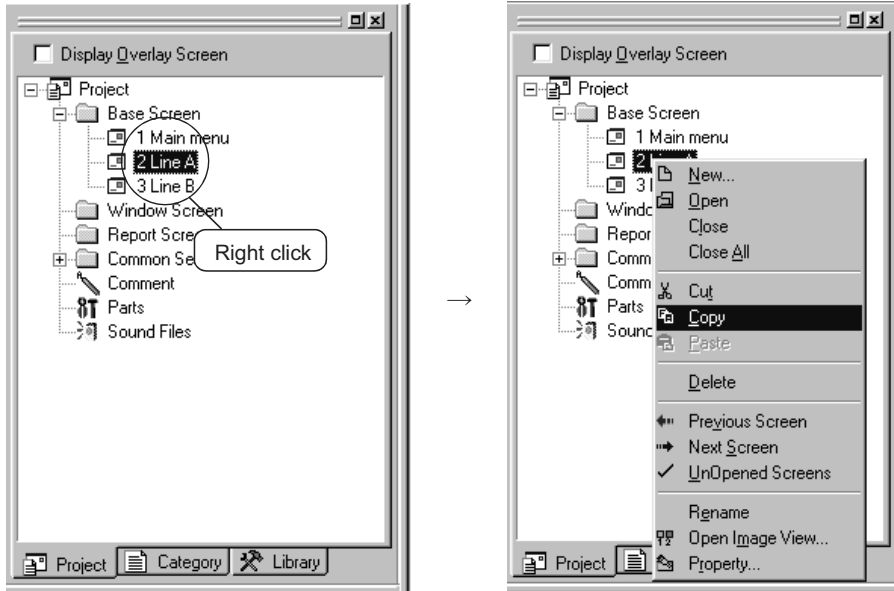
- 5 Perform either of the following operations.
- Click **☞**.
  - Choose the [View] → [Preview] menu.
- 6 The image of the screen, which will be displayed on the GOT, is displayed on the Screen Preview window.  
 For the operation of the Screen Preview window, refer to "Section 4.10.1 Previewing the Base Screen".



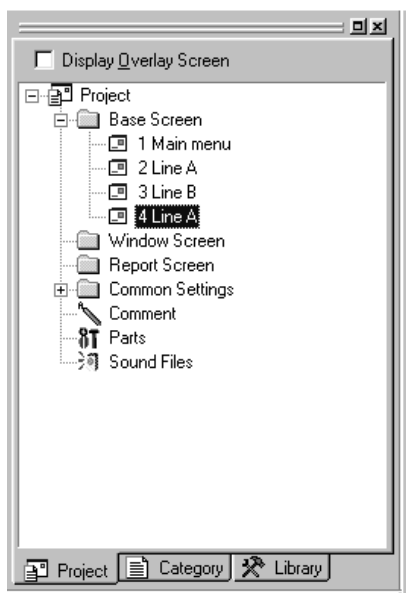
# 4.11 Copying/Deleting Screen

## 4.11.1 Copying screen data

- 1 Select the desired screen for copying in the project workspace and right click the mouse to select the [Copy] menu. Up to 25 screens can be copied at a time.



- 2 Right click the mouse again and select the [Paste].
- 3 The screen property dialog box appears. Set the screen number of the copying screen.  
    ➔ Section 4.5 Creating a New Screen
- 4 After setting, click the  button to display the copied screen.

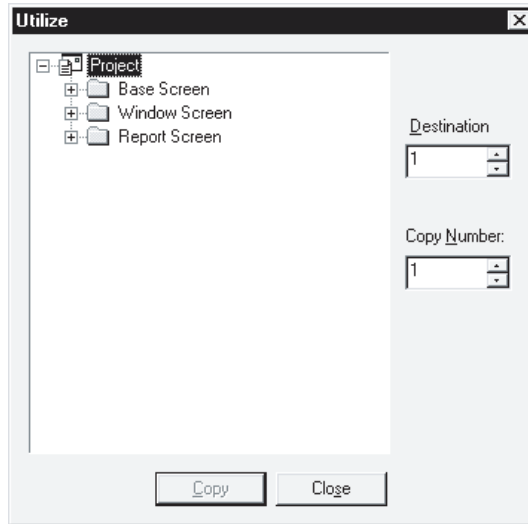


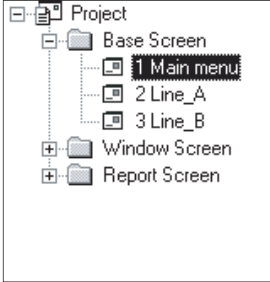
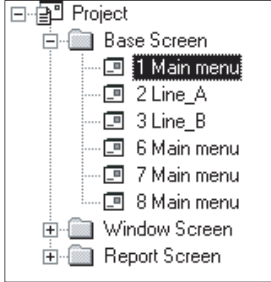
**Remark**

To copy screens continuously

One screen can be copied to multiple screens.

- 1 Select [Screen] → [Utilize].
- 2 The utilize dialog box appears.  
Set the following items and click the **Copy** button.



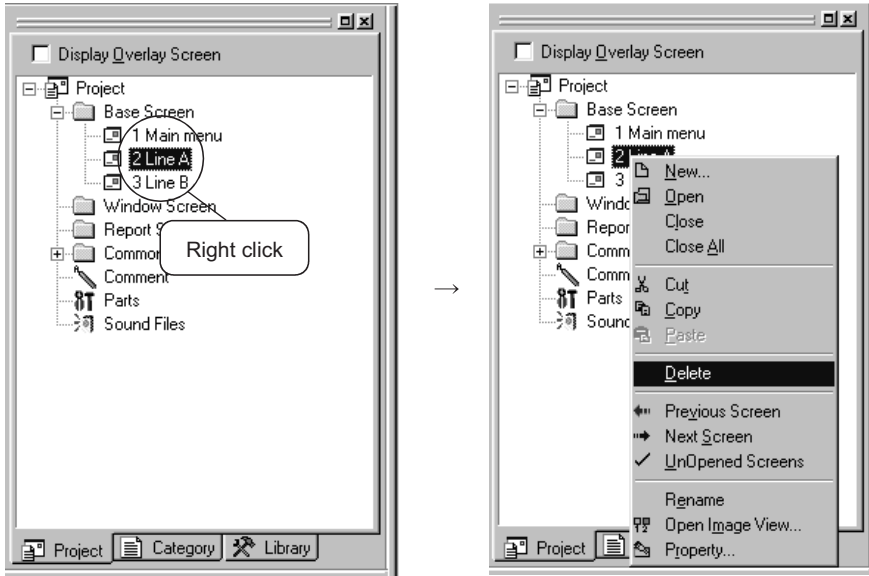
Item	Description	A	F
Project display list	The screen to be copied is selected (up to 25 screens).	<input type="radio"/>	<input type="radio"/>
Destination	Set the copy destination screen number (1 to 32767).	<input type="radio"/>	<input type="radio"/>
Copy Number	<p>The number of copies is set. Up to 100 screens can be copied at a time. Ex.: Copying with destination number "6" and number of copy "3" The screen is copied to base screens 6, 7 and 8.</p> <div style="display: flex; justify-content: space-around;"> <div style="text-align: center;">  <p>Before copy</p> </div> <div style="text-align: center;">  <p>After copy</p> </div> </div>	<input type="radio"/>	<input type="radio"/>

- 3 The screen is copied.
- 4 Property (name, attribute, etc.) of the copied screen is checked or edited.

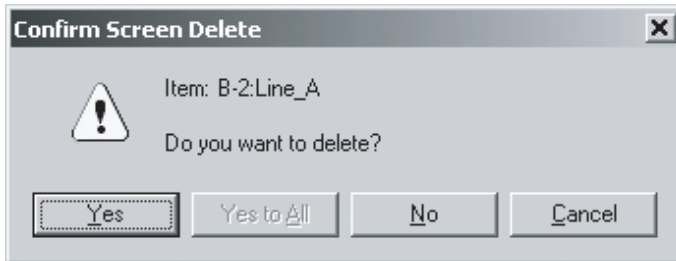
☞ Section 4.5 Creating a New Screen

## 4.11.2 Deleting screen data

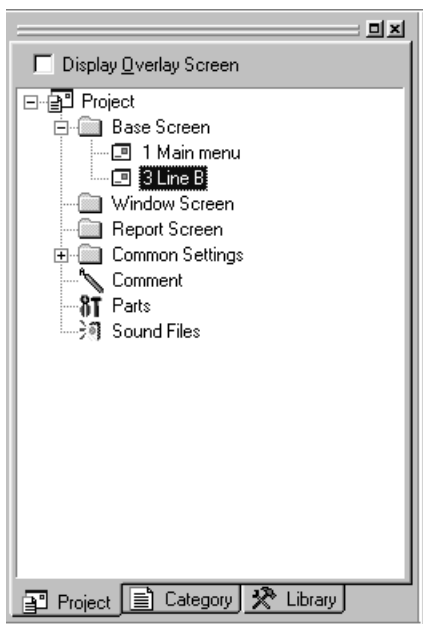
- 1 Select the desired screen for deletion in the workspace (project tab) and right click the mouse to select the [Delete] menu.



- 2 The confirmation screen for deletion of the screen appears. Click the  button.



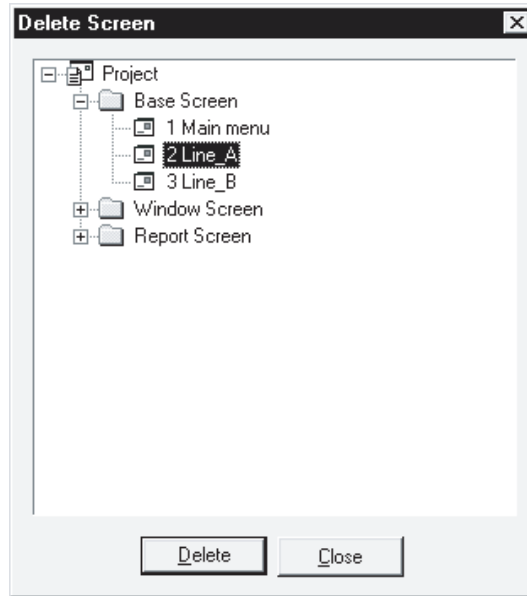
- 3 The selected screen is deleted.



**Remark**

Deleting screen data from menu bar

- 1 Select [Screen] → [Delete] menu.
- 2 The screen deletion dialog box appears. Select the screen to be deleted and click the **Delete** button.




- 3 The selected screen is deleted.

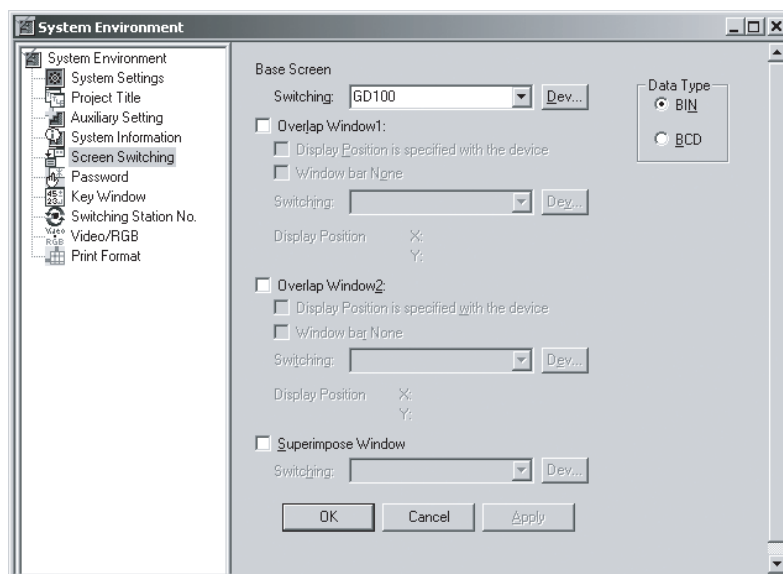
## 4.12 Setting Screen Switching Device

To switch the screen on the GOT or to display the window screen, use the dedicated device for screen switching.

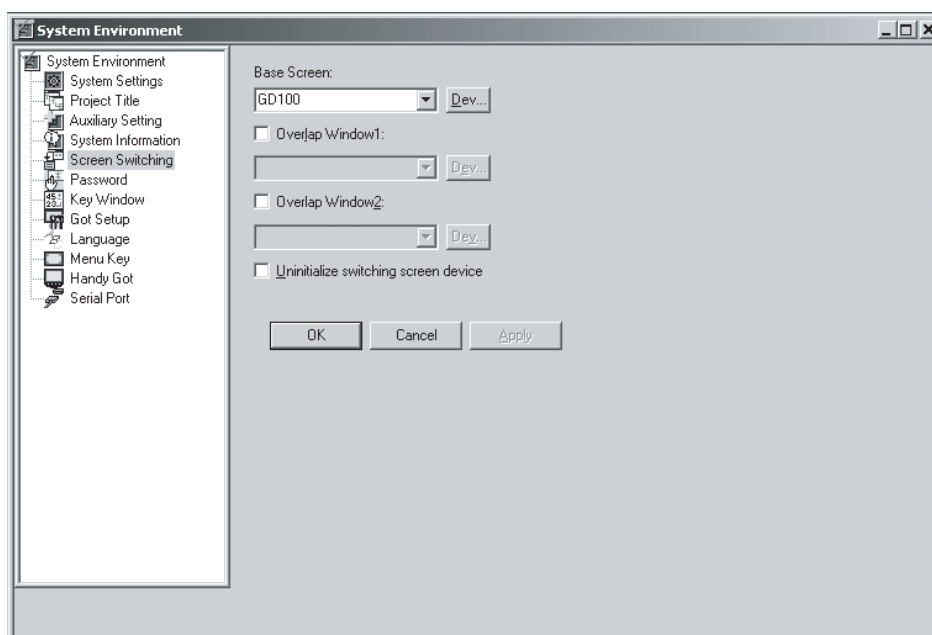
Refer to the manual below for details of the screen switching device.

 GT Designer2 Version□ Reference Manual


- 1 Select [Common] → [System Environment] menu of the menu bar.
- 2 Double click [Screen Switching] of the system environment.
- 3 The screen switching setting dialog box appears.  
After setting, click the **OK** button.



(Setting of GOT-A900 series)



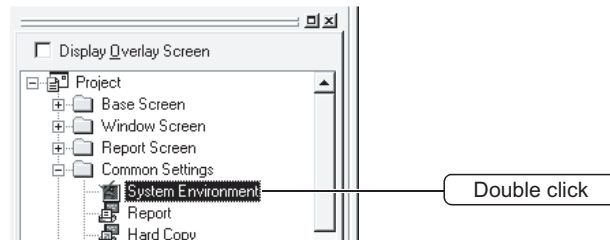
(Setting of GOT-F900 series)

Item	Description	A	F
Data Type	Select the data format for the screen switching device value. BIN: The screen switching device value will be handled as a binary value. BCD: The screen switching device value will be handled as a BCD (binary coded decimal) value. The range of the screen (screen No.) that can be switched changes depending on the set data format. BIN: 1 to 32767 BCD: 1 to 9999	<input type="radio"/>	<input checked="" type="checkbox"/>
Base Screen	The base screen switching device is set. Refer to the manual below for the device setting method.  GT Designer2 Version□ Reference Manual	<input type="radio"/>	<input type="radio"/>
Overlap Window 1 Overlap Window 2	This is checked to display overlap window 1 and overlap window 2. After checking, the screen switching device of each window is set. (When the screen switching device is not set, the window for that type is not displayed.)	<input type="radio"/>	<input type="radio"/>
Display Position is specified with the device	This is checked to specify the window display position with the device value.	<input type="radio"/>	<input checked="" type="checkbox"/>
Window bar None	This is checked not to display the movement key and the close key.	<input type="radio"/>	<input checked="" type="checkbox"/>
Superimpose Window	This is checked to display the superimpose window. After checking, the screen switching device of the super impose window is set. (When the screen switching device is not set, the superimpose window is not displayed.)	<input type="radio"/>	<input checked="" type="checkbox"/>
Uninitialize switching screen device	When "1" is to be input to the device set in Base screen at power ON, this is unchecked. The device value is reset when the PLC is powered ON and it prevents the screen data error from being displayed on the GOT screen.	<input checked="" type="checkbox"/>	<input type="radio"/>

**Remark**

(1) Setting in project workspace

Double click the system environment. The system environment setting dialog box appears. Double click [Screen Switching].

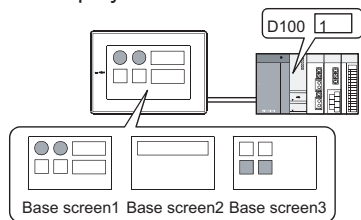


(2) What is the screen switching device?

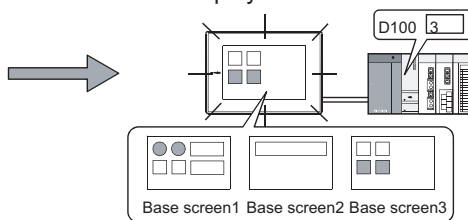
To switch a screen on the GOT or to display the window screen, use the screen switching device.

The GOT displays the screen for the value stored in the screen switching device. Use the device set for the screen switching only for screen switching on the GOT.

When the screen switching device value is "1," the GOT displays base screen 1.



When the screen switching device value is "1 --> 3," the GOT displays base screen 3.

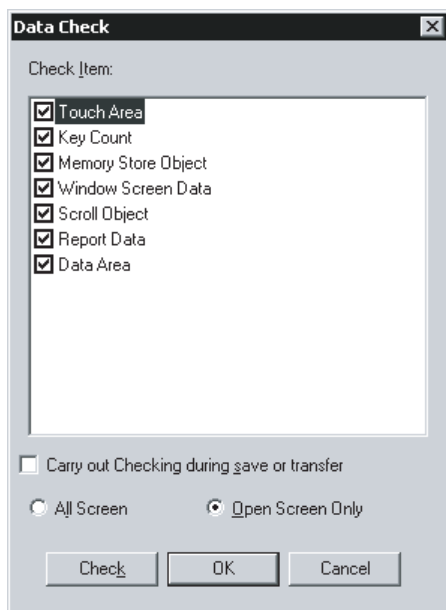




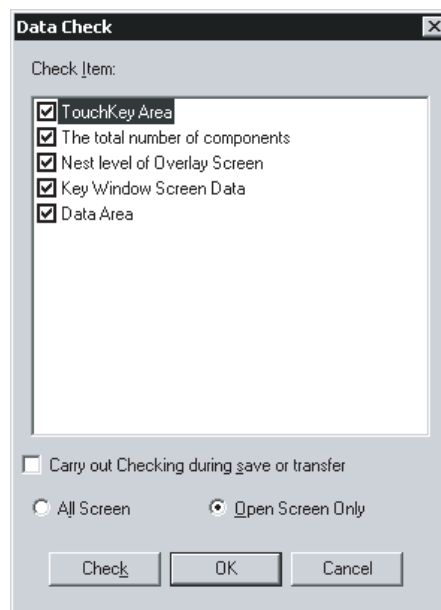
## 4.13 Data Check

Whether the monitor screen data created with the GT Designer2 has an error or not is checked.

- 1 Open all screens for data check. Unopened screens are not data checked.
- 2 Select [Tools] → [Data Check] menu.
- 3 The data check dialog box is displayed.  
Set the check items for data check and click the **Check** button.



(Setting of GOT-A900 series)

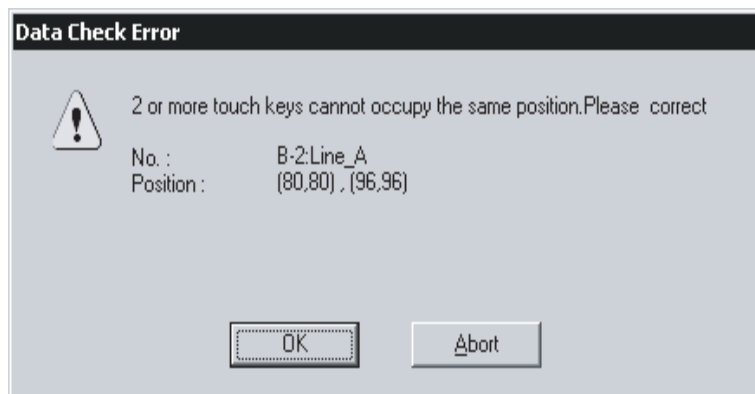


(Setting of GOT-F900 series)

Item	Description	A	F
Check Item	Items for data check are checked.	○	○
Touch Area	Whether overlap of touch switch functions occurs is checked. • Touch switches are overlapped. • Numerical input/ASCII input is overlapped with touch switches.	○	○
Key Count	Checks whether more than 1000 touch switch functions (all touch switch objects) are placed in the GOT display area for each screen (Front and Back).	○	○
Memory Store Object	Checks whether the objects exceeding the following numbers are set to be stored into memory. Line graph (path display): 2 or more/project Trend graph (memory store): 17 or more/project Scatter graph (memory store): 17 or more/project User alarm (memory store): 17 or more/project	○	×
Window Screen Data	Whether the data list or the alarm history is set on the window screen is checked. (The data list and the alarm history cannot be displayed on the window screen.)	○	×
Scroll Object	Whether multiple objects with scroll display (data list, alarm history and alarm list) are set on one screen is checked.	○	×
Report Data	When the report screen is created, whether the numerical print or the comment print is set on the header is checked.	○	×
Number of object entries	Whether the number of objects that can be registered on one screen exceeds the limit is checked.	×	○
Nest level of set overlay screens	Whether the nest level of set overlay screens is within 5 that can be set on one screen is checked.	×	○

Item		Description	A	F
Check Item	Key window screen data	Whether there is any object that cannot be set on the window screen is checked.	×	○
	Data Area	Whether any object is set outside the screen range is checked.	○	○
Carry out Checking during save or transfer		Data check is automatically performed when a project is saved or a monitor screen data is transferred to the GOT.	○	○
All Screen		Perform data check on all screens.	○	○
Open Screen Only		Perform data check on open screen.	○	○

- 4 When the data check is performed with the settings, click the  button.  
(To close the dialog box after updating the settings, click the  button.)
- 5 If an error is detected after checking, the following screen is displayed.  
(Ex.)




- When  is clicked, data check is continued for any other error.  
When  is clicked, data check is cancelled.

## 4.14 Saving Project

### 4.14.1 Overwriting and saving project

When an existing data has been edited, the project is overwritten and saved.

1 Perform either of the following operations.

- Click  (Overwrite).
- Select [Project] → [Save] menu.

#### **Point**

When using FD (floppy disk).

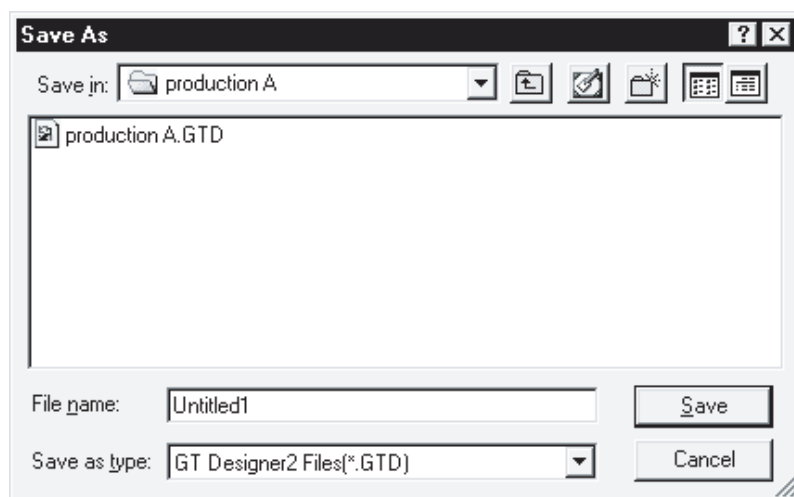
When a project is overwritten and saved, the same size of free disk space as the project data size is required. If an FD is used, overwriting and saving may not be carried out due to insufficient disk space.

If overwriting and saving is not allowed, save the project in the PC hard disk. Then, copy it to the FD.

### 4.14.2 Saving as project name

When a newly created project is saved or an existing project is saved with a different project name, set as follows:

- 1 Select [Project] → [Save as].
- 2 The save as dialog box appears.  
Set the following items and click the **Save** button.



Item	Description	A	F
Save in	The location to save the project is selected.	<input type="radio"/>	<input type="radio"/>
File name	The project name to be saved is set.	<input type="radio"/>	<input type="radio"/>
Save as type	GT Designer2 Files (*.GTD) The project data is saved in the GT Designer2 format (*.GTD). Intel Hex Files (*.ITH) Intel Hex Files (*.ITH) is the file format for the data transfer between the ROM writer and the PC. The project data is saved in the Intel hex format (*.ITH). F900GOT Binary Files (*.FI) (Only GOT-F900 series) The project data for the data transfer tool is saved in the F900GOT binary format (*.FI). The project data cannot be saved in the other formats, including GT Designer and DU-WIN.	<input type="radio"/>	<input type="radio"/>




#### When an existing project is saved as a different project

The library data (GTD2.ldb) with registration of user-created objects and figures are not saved as a different project file.

The project saved as a different project refers to the same library data (GTD2.ldb) as the existing project.

If you want to separate a library from the existing project data, save the existing project library as a different file.

 Section 7.3.6 Saving library


## 4.15 Ending GT Designer2

---

- 1 Select [Project] → [Exit].
- 2 The GT Designer2 is ended.

### **Remark**

Ending GT Designer2 from title bar

Click  on the title bar to end the GT Designer2.









# 5. DATA TRANSFER OPERATION

## 5.1 Type and Size of Transfer Data to GOT

### 5.1.1 Data type to be installed on GOT

To operate the GOT, it is necessary to transfer the following data to the GOT.

(In the GOT-F900 Series, as the data including the OS has been written prior to shipment, the data transfer is not necessary.)

Item	Transfer destination *1 (Area in GOT)	Necessity	Reference	A	F
ROM_BIOS	Dedicated memory	△	 <b>1</b> in this section	○	×
OS	Standard monitor OS	○	 <b>2</b> in this section	○	×
	Communication driver	○	 <b>3</b> in this section	○	×
	Extended function OS	△	 <b>4</b> in this section	○	×
Monitor data (Provided by user)	Built-in memory	○	 <b>5</b> in this section	○	○
Special data (special module/motion/ servo amplifier monitor data)	Built-in memory	△	 <b>6</b> in this section	○	×

○ : Data must be transferred.

△ : Data needs to be transferred depending on the function.

#### \*1 Transfer destination

**Dedicated memory:** Area to store the ROM\_BIOS, standard monitor OS and communication driver.  
Calculation or addition of the memory space is not required.

**Built-in memory:** Area to store the extended function OS, monitor data and special data.  
Calculation of the memory space and addition of the memory is required as necessary.

#### **Point**

##### (1) Downloading monitor data

When the version of the ROM\_BIOS and the OS (standard monitor OS, communication driver and extended function OS) of the GT Designer2 is later than that of the system program installed on the GOT, the new functions may not be compatible.

It is recommended to reinstall the ROM\_BIOS and the OS when downloading the monitor data to the GOT.

##### (2) Installing OS

Make sure that the version numbers (leftmost version) of the OS (standard monitor OS, communication driver and extended function OS) are the same. If the version numbers are different, the GOT is not operated.

(Ex. 1)

Standard monitor OS : Ver. 9.\*.\*  
Communication driver : Ver. 9.\*.\*  
Extended function OS : Ver. 9.\*.\*

The GOT is operated.

(Ex. 2)

Standard monitor OS : Ver. 9.\*.\*  
Communication driver : Ver. 8.\*.\*  
Extended function OS : Ver. 8.\*.\*

The GOT is not operated.

# 1 ROM\_BIOS

It is the data required for control of the GOT hardware and communication between the PC and the GOT.

The ROM\_BIOS is installed prior to shipment of the GOT.

To use the following types/functions, the ROM\_BIOS of the applicable version needs to be installed to the GOT.

Type/function name	Applicable ROM_BIOS version
Use of flash PC card	Version F or later
MELSEC-Q/QnA ladder monitor function	Version H or later
A9GT-QFNB8M A9GT-FNB8M	Version H or later
A9GT-FNB1M (Hardware version B or later) A9GT-FNB2M (Hardware version B or later) A9GT-FNB4M (Hardware version B or later) A9GT-QFNB (Hardware version B or later)	Version M or later
Use of base screen numbers from 1024 to 4096	Version P or later
Ethernet connection	Version Q or later
Gateway function	Version S or later
CNC monitor function	Version W or later
KANA KANJI function	
Font change function	Version X or later

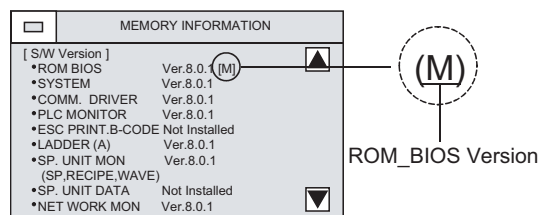
## (1) Check method of ROM\_BIOS

The ROM\_BIOS version installed to the GOT can be checked with the GOT memory information or the rating nameplate.

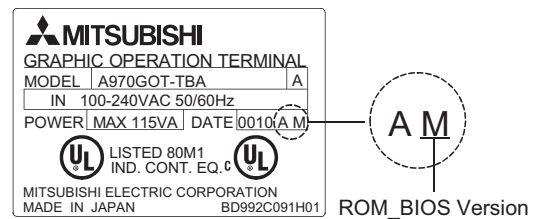
If a user has upgraded the ROM\_BIOS, the ROM\_BIOS version installed on the GOT is different from the version on the rating nameplate. Check the version from the memory information.

Immediately after purchase of the product, the version may be checked with the rating nameplate.

(a) Memory information



(b) Rating nameplate

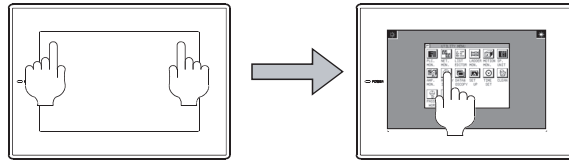


## **Remark**

Display method of memory information

Display the GOT memory information on the utility.


<Display example of memory information>



Touch the upper right and the upper left of the screen at the same time.

Select the utility memory information.

Refer to the manual below for the start-up method and the operation method of the utility.

 GOT-A900 Series Operating Manual (Extended • Option Functions Manual)

### (2) Upgrading method

The ROM\_BIOS can be upgraded with the method below:

#### (a) Upgrading with RS-232 communication

 Section 5.2 Transferring data with RS-232 cable

#### (b) Upgrading with memory card

 Section 5.3 Transferring Data Using Memory Card

## **2** Standard monitor OS

It is the program to control the monitor function.



### 3 Communication driver

It is the driver to make communication between the GOT and the PLC CPU.  
Select the communication driver suitable for the connection type.

Connection type		Communication driver name
Bus connection	QCPU (Q mode)	Bus (Q)
	A/QnACPU	Bus (A/QnA)
CPU direct connection	A/QnA/QCPU, MELDAS C6/C64	A/QnA/QCPU, QJ71C24, MELDAS C6*
	FXCPU	MELSEC-FX
Computer link connection	QCPU	A/QnA/QCPU, QJ71C24, MELDAS C6*
	QnACPU	AJ71QC24
	QCPU (A mode), ACPU	AJ71C24/UC24
MELSECNET connection	Data link system	MNET2/B
	Network system	MNET/10 (A/QnA/Q) MNET/10 (A)
CC-Link connection	Remote device station	CC-LINK(RD)
	Intelligent device station	CC-LINK (ID)
	Through G4	CC-LINK(G4)
Ethernet connection		QJ71E71/AJ71(Q)E71
OMRON PLC connection		OMRON SYSMAC
YASKAWA PLC Connection		YASKAWA GL/CP9200 (SH/H)/CP9300MS Series
Microcomputer connection		Microcomputer connection
Allen-Bradley PLC connection		AB SLC500, AB1: N connection
		AB Micrologix
SHARP PLC connection		SHARP JW
TOSHIBA PLC connection		TOSHIBA PROSEC T/V
SIEMENS PLC connection		SIEMENS S7-300/400
HITACHI PLC connection		HITACHI HIDIC H
		HITACHI H (Protocol 2)
MATSUSHITA Electric Works PLC connection		MATSUSHITA MEWNET-FP

Refer to the manual below for details of the connection type.

 GOT-A900 Series Users Manual (Connection System Manual)

## 4 Extended function OS

It is the program to use the following functions on the GOT.

- Ladder monitor function
- Network monitor function
- Motion monitor function
- KANA KANJI function\*1
- Bar code function
- Hard copy function
- Creating CSV format file with alarm history function or/and recipe function
- System monitor function
- List editor function
- Servo amplifier monitor function
- Recipe function
- Report function
- Printer output
- Special function module function
- Gateway function
- CNC monitor function
- Sound function
- Operation panel function

\*1 This function is dedicated to Japanese version.

### (1) Combination of extended function OS that can be installed

The extended function OS is installed in the built-in memory of the GOT.

The extended function OS can be installed up to 6 in total equivalent to the number of required memories.

Either one of "ladder monitor", "motion monitor/CNC monitor" and "other" extended function OS can be installed.

Extended function OS name		Number of required memories at installation	Remark
System monitor		1	—
Ladder monitor	Ladder monitor for MESELC-A	1	Only one can be installed.
	Ladder monitor for MESELC-QnA *1	2	
	Ladder monitor for MESELC-Q *1	2	
	Ladder monitor for MESELC-FX	1	
Motion monitor *1		2	Only one can be installed.
CNC monitor *1		2	
Special unit, recipe, sound		1	—
Network monitor		1	—
List editor function for MESELC-A *1		2	—
Gateway (Server, client, mail, FTP) *1		2	—
Servo amplifier monitor *1		2	—
KANA KANJI (JPN) *1		2	—
Others *2	ESC printer, bar code, report, CSV, keyboard	1	Only one can be installed.
	PCL printer, bar code, report, CSV, keyboard	1	
	ESC printer, bar code, report, CSV, I/O	1	
	PCL printer, bar code, report, CSV, I/O	1	
	ESC printer, bar code, report, CSV, video/RGB	1	
	PCL printer, bar code, report, CSV, video/RGB	1	
	Chinese (Big 5) printer, bar code, report, CSV, keyboard	1	
	Chinese (Big 5) printer, bar code, report, CSV, I/O	1	
	Chinese (Big 5) printer, bar code, report, CSV, video/RGB	1	
	Chinese (GB) printer, bar code, report, CSV, keyboard	1	
	Chinese (GB) printer, bar code, report, CSV, I/O	1	
	Chinese (GB) printer, bar code, report, CSV, video/RGB	1	

\*1: When the number of required memories installed on the GOT is 4 or less, the OS may not be installed. If the OS cannot be installed, delete all extended function OS installed on the GOT and then reinstall the extended function OS again.

\*2: Select "Other" extended function OS referring to Point on the next page.



### Selection point of "Other" extended function OS

- (1) Install "Other" extended function OS when the following functions are used.
- Report function
  - Video display function
  - Printer output
  - Hard copy function (File save)
  - Creating CSV format file with alarm history function or/and recipe function
  - Operation panel function
  - RGB display function
  - Gateway function (Send mail)
  - Bar code function
  - External I/O function
- (2) In "Other" extended function OS, only items of 1) (Language) and 2) (Device) below are different. Other items (bar code, report and CSV) are the same. Select "Other" extended function OS referring to 1) and 2).

#### 1) Selection by printer connected to the GOT or language output to the CSV file

- ESC printer : Output/send mail in Japanese
- PCL printer : Output in English
- Chinese (Big 5) printer : Output in Chinese (Traditional characters)
- Chinese (GB) printer : Output in Chinese (Simplified characters)

#### 2) Selection by optional equipment

- Keyboard : Operation panel, ten-key panel (operation panel function)
- I/O : External I/O device (external I/O function)
- Video/RGB : Video camera (video function), PC (RGB function)

### (2) Relation between extended function OS and built-in OS

When the extended function OS is installed, the memory space below is always used regardless of each extended function OS data size.

If the built-in memory is not sufficient, mount the memory board on the GOT (Use - M3 type for the A95\*GOT.) to increase the built-in memory space. (The space added with the memory board is used as the memory only for the monitor data and the special data.)

Total count equivalent to required memories for extended function OS	Memory space used by extended function OS (k byte)	Space to store monitor data and special data (k byte) *1
0	0	1152
1	256	896
2	384	768
3	640	512
4	768	384
5	1024	128
6	1152	0

\*1 The space without the memory board (Use the type without -M3 on the A95\*GOT.) is assumed.


## 5 Monitor data

It is the monitor screen data created by the user.

## 6 Special data

It is the dedicated screen data used for the special module monitor function, motion monitor function and servo amplifier monitor function.

Refer to the manual below for details of each function.

 GOT-A900 Series Operating Manual (Extended • Option Functions Manual)

## 5.1.2 Memory space required for data transfer

The extended function OS, monitor data and special data are transferred to the built-in memory of the GOT. If the built-in memory does not have sufficient space, the data cannot be transferred. Check the built-in memory space and the transfer data size before transfer of the data.



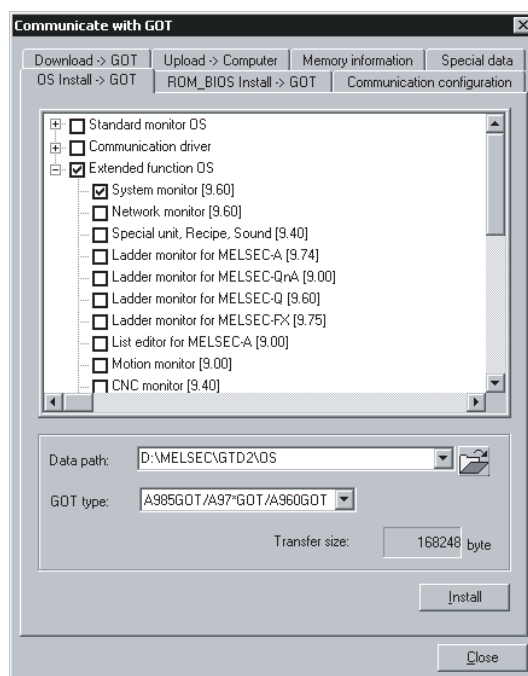
Check method of memory space

(1) New data transfer (No data has been transferred to the GOT.)

- 1 Check the total count equivalent to the required memories for installation of the extended function OS.

Section 5.1.1 **4** (1) Combination of extended function OS that can be installed

- 2 Check the GOT built-in memory size used by the extended function OS from the total count equivalent to the required memories.



Section 5.1.1 **4** (2) Relation between extended function OS and built-in OS

- 3 Check the size of the monitor data or the special data to be downloaded.

**2** in this section Check method of transfer data size

- 4 Extended function OS + Monitor data + Special data size < Remaining memory size of GOT → Installation is allowed.  
Extended function OS + Monitor data + Special data size > Remaining memory size of GOT → Installation is not allowed.

Ex.) GOT memory size : 1152 KB (without memory board)  
Count equivalent to memories of extended function OS : 3 (640 KB)  
Monitor data : 300 KB  
Special data : 26 KB  
640 + 300 + 26 < 1152 → Installation is allowed.

(2) Data has already been transferred to the GOT.

① Check the built-in memory.



① in this section Check method of GOT free space

② Check the monitor data size or the special data size to be added.



② in this section Check method of transfer data size

③ Monitor data + special data size < Remaining memory size of GOT →  
Installation is allowed.

Monitor data + special data size > Remaining memory size of GOT →  
Installation is not allowed.

### **Point**

When free space of built-in memory is sufficient but the insufficient space message appears

[Delete all old monitor data] check and download all monitor data.

When it is necessary to back up the monitor data, upload it to the PC or memory card before downloading.

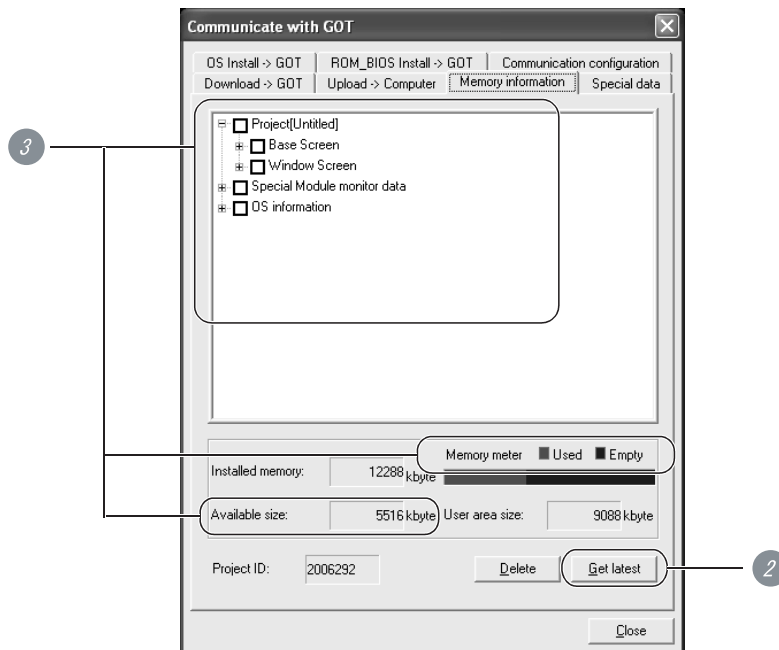
## 1 Check method of GOT free space

- (1) Check the space with the GT Designer2.  
When the space is checked with the GT Designer2, connect the GOT to the PC with the RS-232 cable.

- 1 Click the [Communication] → [Memory Information] menu.
- 2 The communication configuration dialog box (Memory information tab) appears. Click the Get Latest button.
- 3 The free space is indicated in the [Available space] and the [Memory meter]" of the GOT built-in memory.

Refer to the following for details of each item in the built-in memory information.

☞ Section 5.2.2 Getting built-in memory information



- (2) Check the space with the GOT.  
The space can be checked with the built-in memory information of the utility.  
Refer to the manual below for start-up method and operation method of the utility.

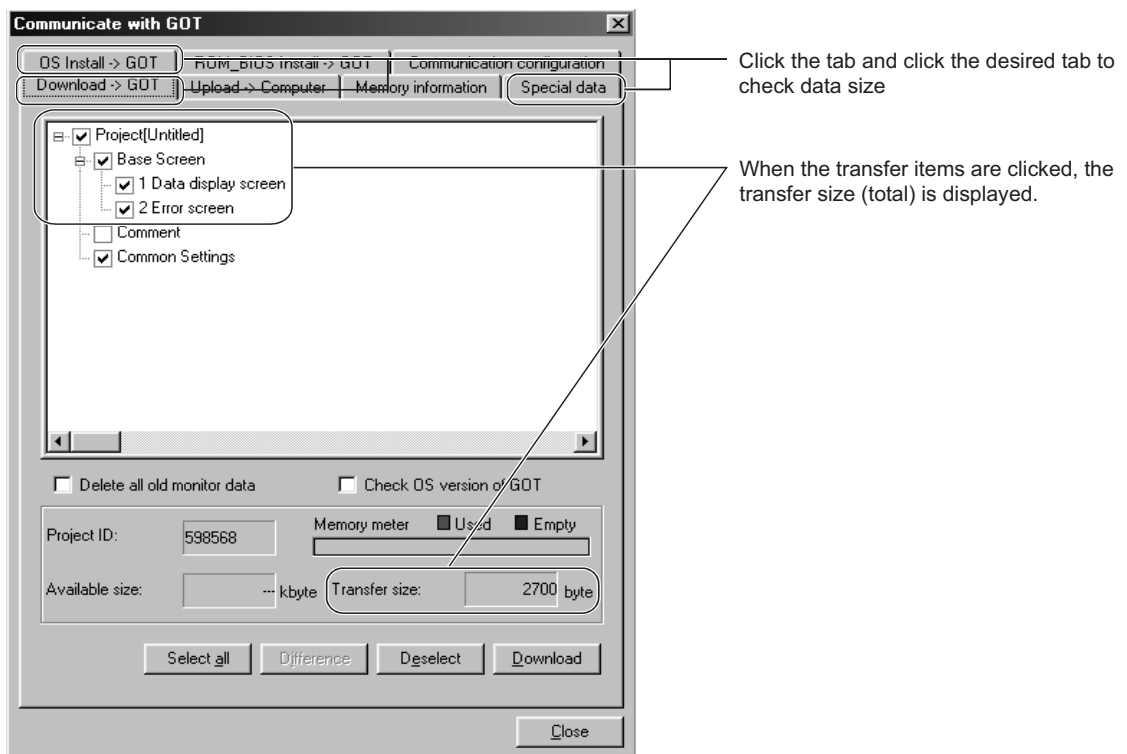
☞ GOT-A900 Series Operating Manual (Extended • Option Functions Manual)

MEMORY INFORMATION	
[ S/W Version ]	
• ROM BIOS	Ver.8.0.1 [M]
• SYSTEM	Ver.8.0.1
• COMM. DRIVER	Ver.8.0.1
• PLC MONITOR	Ver.8.0.1
• ESC PRINT.B-CODE	Not Installed
• LADDER (A)	Ver.8.0.1
• SP. UNIT MON (SP,RECIPE,WAVE)	Ver.8.0.1
• SP. UNIT DATA	Not Installed
• NET WORK MON	Ver.8.0.1

## 2 Check method of transfer data size

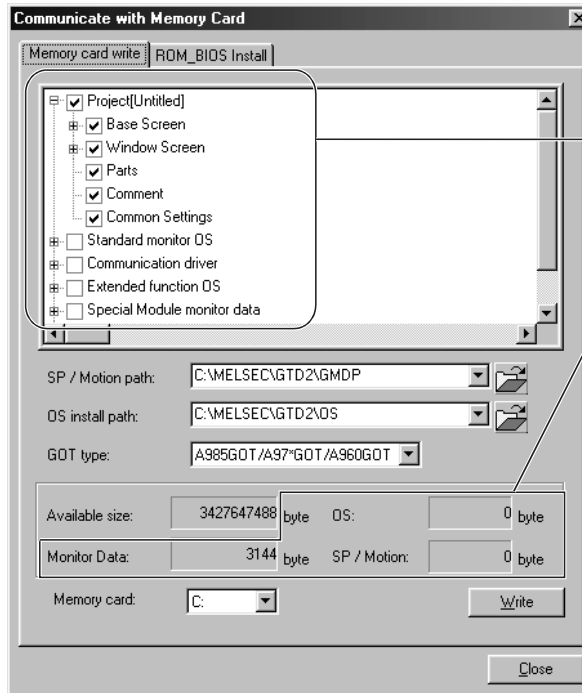
- 1 Select [Communication] → [To/From GOT]/[To Memory Card] menu.
- 2 The Communicate with GOT dialog box or the Communicate with PC Card dialog box appears.  
Each data size can be checked in each dialog box.  
Refer to the following for details of each dialog box.
  - Communicate with GOT dialog box
    - ☞ Section 5.2.4 Installing ROM\_BIOS
  - Communicate with PC Card dialog box
    - ☞ Section 5.3.2 Transferring OS, monitor data and special data

### (1) Communicate with GOT dialog box





(2) Communicate with PC Card dialog box



When the transfer items are clicked, the transfer size (total) is displayed.

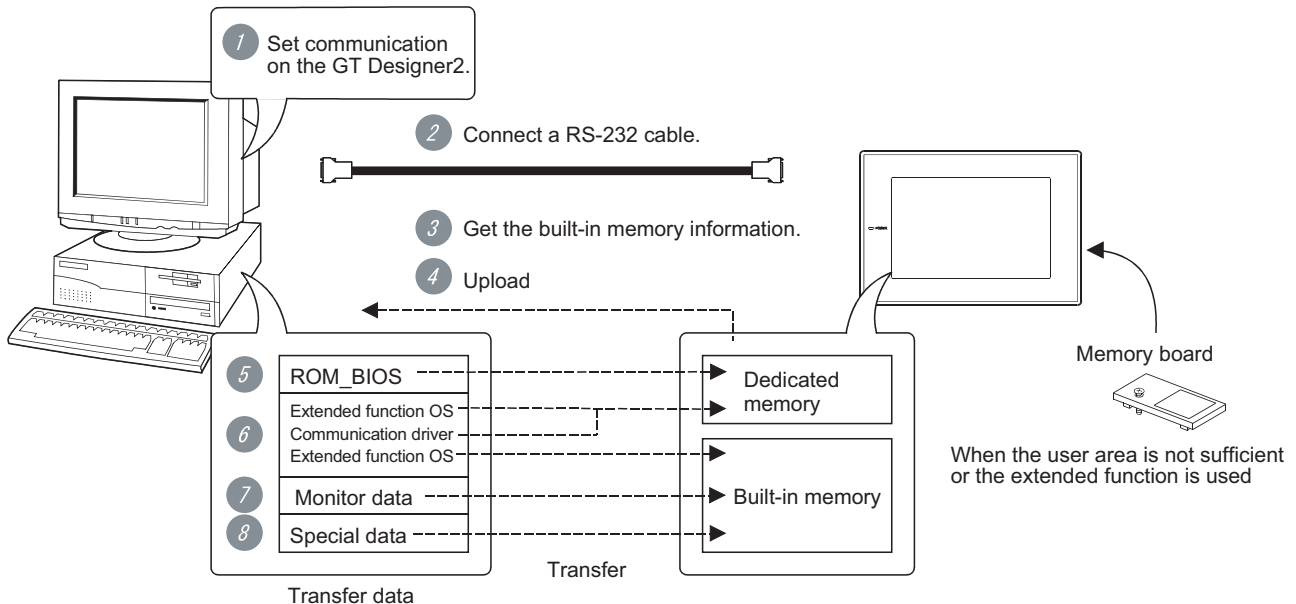
## 5.2 Transferring data with RS-232 cable

The data transfer method with RS-232 cable is described.

As data transfer is operated with the GT Designer2, operation on the GOT side is not necessary.

### 1 Procedures

The data is transferred in the following procedures.



- 1 Set communication on the GT Designer2. .... Section 5.2.1 Setting communication
- 2 Connect a RS-232 cable..... Section 2.2.2 RS-232 cable to be used
- 3 Get the built-in memory information..... Section 5.2.2 Getting built-in memory information
- 4 Upload (Operation is not required for the first upload.)  
..... Section 5.2.3 Uploading
- 5 ROM\_BIOS (GOT-A900 Series only)..... Section 5.2.4 Installing ROM\_BIOS
- 6 Standard monitor OS, communication driver and extended function OS (GOT-A900 Series only)  
..... Section 5.2.5 Installing OS
- 7 Monitor data ..... Section 5.2.6 Downloading monitor data
- 8 Special data (GOT-A900 Series only) ..... Section 5.2.7 Downloading special data

### **Remark**

#### Monitor data transfer

To transfer monitor data, the project must be opened on the GT Designer2.  
Other data than the monitor data can be transferred when the project is not opened on the GT Designer2.

## 2 Caution

- (1) RS-232 cable  
Make sure that the RS-232 cable connector is securely connected to the GOT and the PC.
- (2) Precaution for uploading  
When the "upload destination" is specified as a project file (.GTD) of the GT Designer2, all data in the specified project file are deleted. (Even for a partial uploading (comment data, etc.), all data in the file are also deleted.)
- (3) Monitor data uploaded from GOT  
If monitor data downloaded to the GOT is uploaded again from the GOT, all tabs of the object setting dialog box are displayed.
- (4) Data transfer timing  
While the message "Communicating with CPU" is displayed on the GOT when the GOT power is turned ON, communication from the PC is not accepted.  
Transfer the data after the message has gone.
- (5) Detailed explanation and category set on project or screen  
Detailed explanation and category set on the project or the screen are not downloaded to the GOT. Therefore, they are not saved if they are uploaded again from the GOT after downloading.
- (6) Data in GOT  
When the same data as the data to be downloaded is present in the GOT, it is overwritten in downloading.
- (7) Power saving function of PC  
When data is transferred with the GOT connected, turn OFF the power saving function of the PC and Windows®.  
Refer to the PC manual or Windows® Help for details of the power saving function setting.

- (8) When a communication error has occurred  
 A communication error, such as a time-out error, may occur due to the communication port settings on the PC. Check and change the settings in the following procedure.  
 The following items may not be present depending on the PC used.

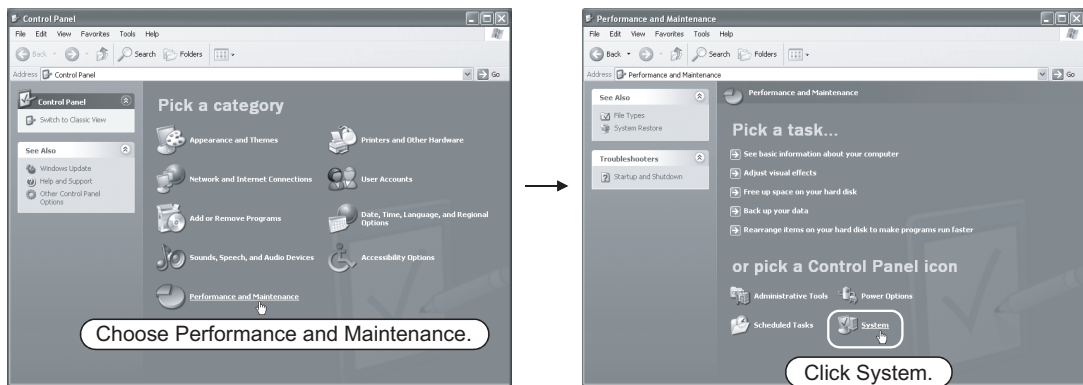
<Method 1>

The following screens and operations apply to Windows® XP.

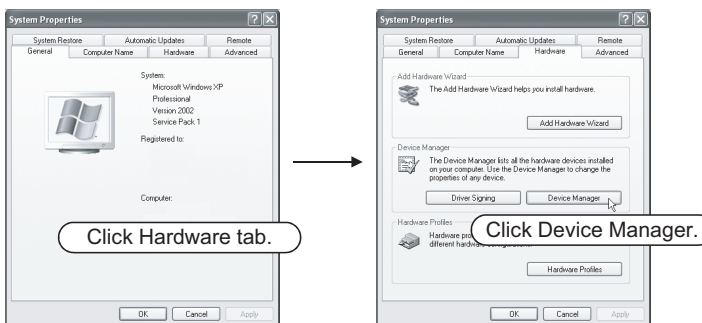
- 1 Choose [Start] → [Control Panel].  
 (For Windows® 2000, choose [Start] → [Settings] → [Control Panel].)



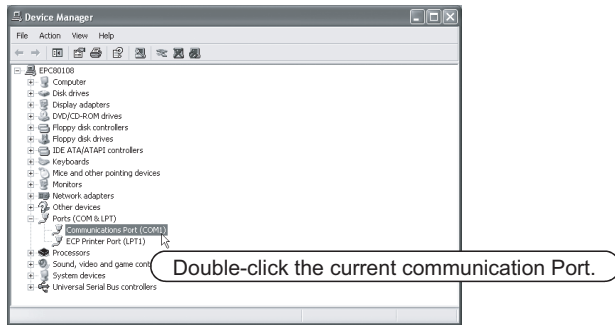
- 2 Choose [Performance and Maintenance] and click the [System] icon.  
 The System Properties dialog box will appear.  
 (For Windows® 2000, double-click [System].)



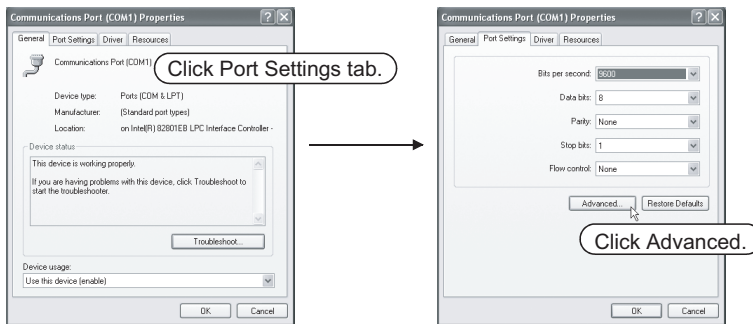
- 3 Click "Device Manager" on the Hardware tab.  
 The Device Manager window will appear.



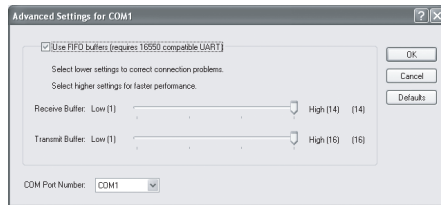
- Choose "Ports" and double-click the "Communication Port" icon.  
The Communication Port Properties dialog box will appear. (When COM1 is selected)



- Click the Detail Setting button of the port setting tab to display the detail setting dialog box of the port.



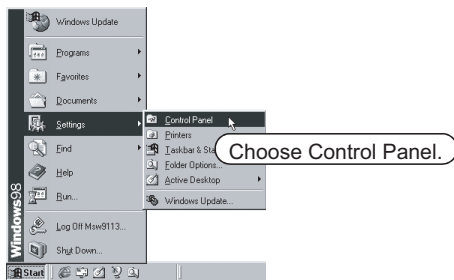
- Uncheck [Use FIFO buffers].



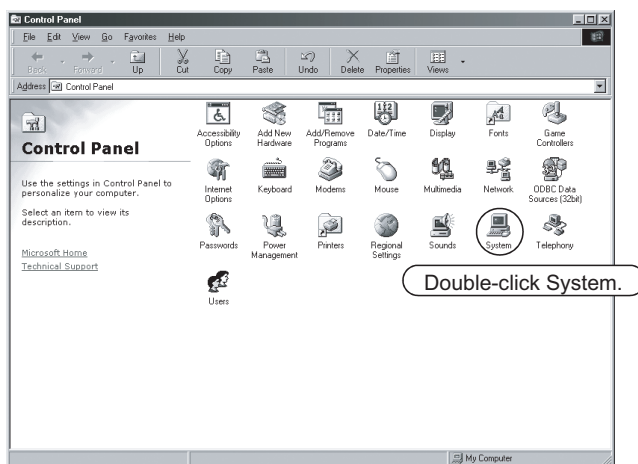
<Method 2>

The screens and operations apply to Windows® 98.

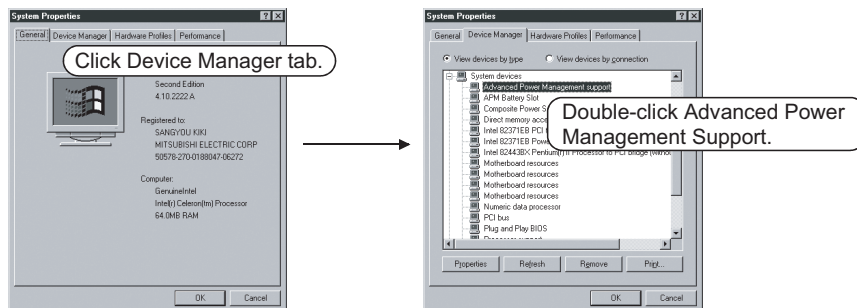
- 1 Choose [Start] → [Settings] → [Control Panel].



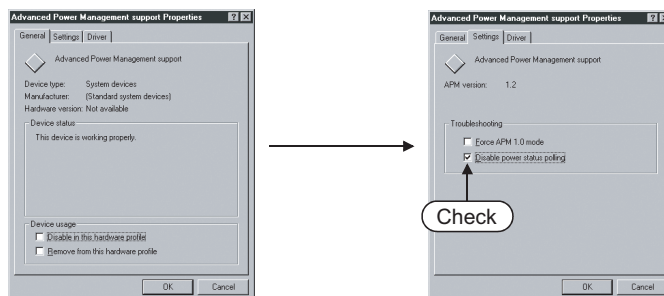
- 2 Double-click the "System" icon.  
The System Properties dialog box will appear.



- 3 Click the Device Manager tab (when displayed by type), choose [System devices], and double-click the [Advanced Power Management Support] icon.  
The Advanced Power Management Support Properties dialog box will appear.



- 4 Check [Disable power status polling] on the Setting tab.

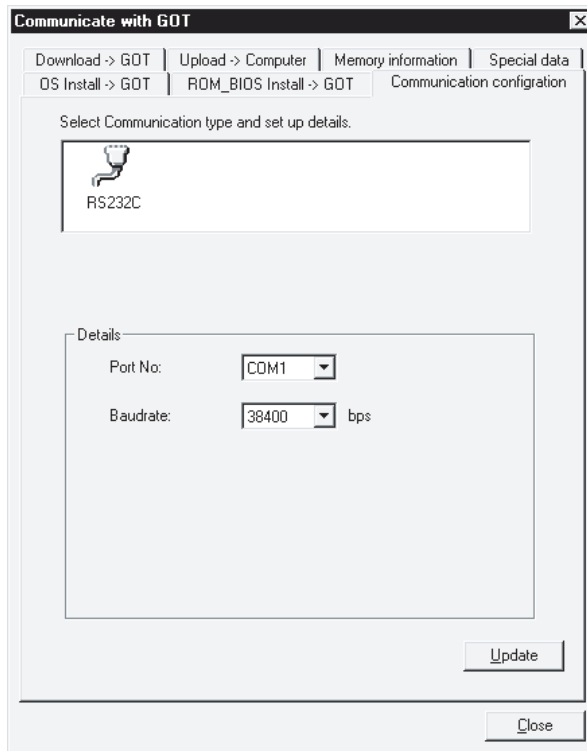


## 5.2.1 Setting communication

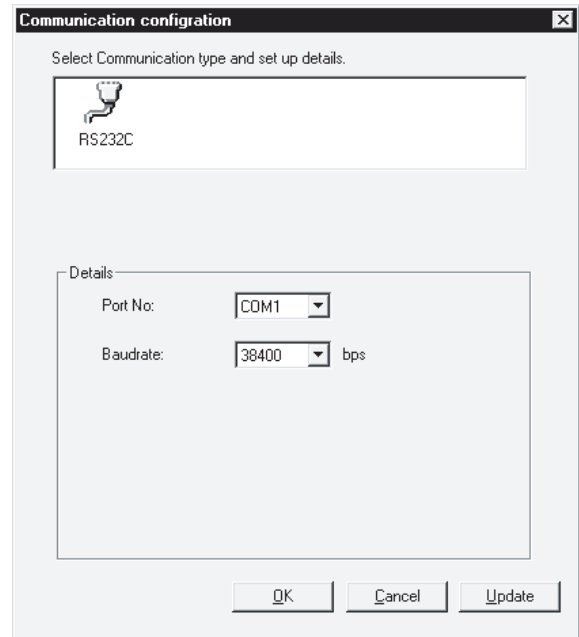
Communication setting of the PC that transfers data to the GOT is made. Settings can be made in either the Communicate with GOT dialog box or the Communication Configuration dialog box.

(When one dialog box is set, the other dialog box automatically has the same settings.)

- 1 Click the [Communication] → [Communicate with GOT]/[Communication Configuration].
- 2 The setting dialog box appears. Make settings referring to the description below.



Communicate with GOT dialog box  
(Communication configuration tab)



Communication Configuration dialog box

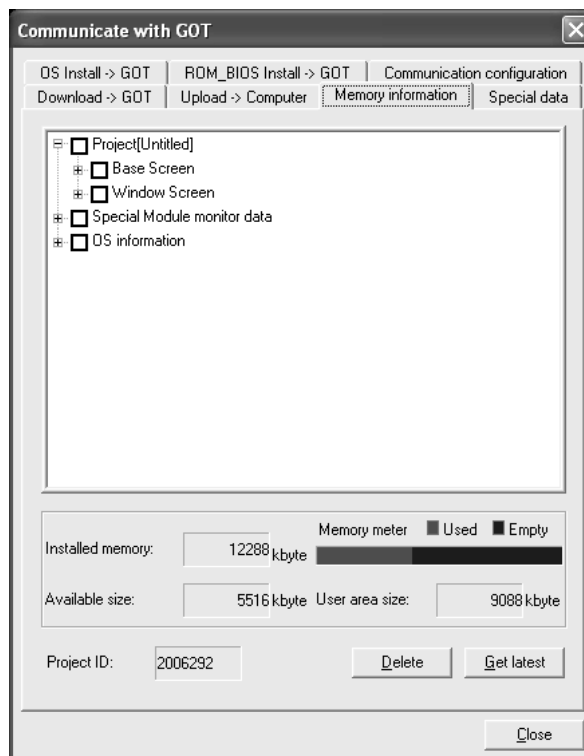
(GOT-A900 Series)

Item	Description	A	F
Port No.	PC port connected to the GOT is selected.	<input type="radio"/>	<input type="radio"/>
Baudrate	The transmission speed between the PC and the GOT is set. Set the rate suitable for the PC.	<input type="radio"/>	<input type="radio"/>
<input type="button" value="Update"/>	When the settings are changed, the settings are updated. Click the <input type="button" value="Update"/> button to update the settings.	<input type="radio"/>	<input type="radio"/>

## 5.2.2 Getting built-in memory information

The method to check the built-in memory is shown below:

- 1 Perform either of the following operations.
  - Click the [Communication] → [Memory Information] menu.
  - Click the [Communication] → [To/From GOT] menu.
 As the setting dialog box appears, click the Memory Information tab.
- 2 The setting dialog box appears.  
Click the **Get latest** button to get the built-in memory information.



Item	Description	A	F
Built-in memory information tree *1	Configuration of the monitor data, special data and OS is displayed in a tree. Right click the mouse to "Select All" or "Unselect".	○	○
Installed memory *1	Built-in memory size of the GOT is displayed. (k bytes unit)	○	○
Available size *1	Size of memory that can be used by the user is displayed. (k bytes unit)	○	○
Memory meter *1	Area that can be used by a user is displayed as a meter. Red: Used area Blue: Free space	○	○
User area size *1	Size of memory used by the user is displayed. (k bytes unit)	○	○
Project ID *1	Project ID is displayed.	○	○
<b>Delete</b>	Items checked in the built-in memory information tree are deleted from the built-in memory.	○	○
<b>Get latest</b>	Built-in information of the GOT is obtained.	○	○

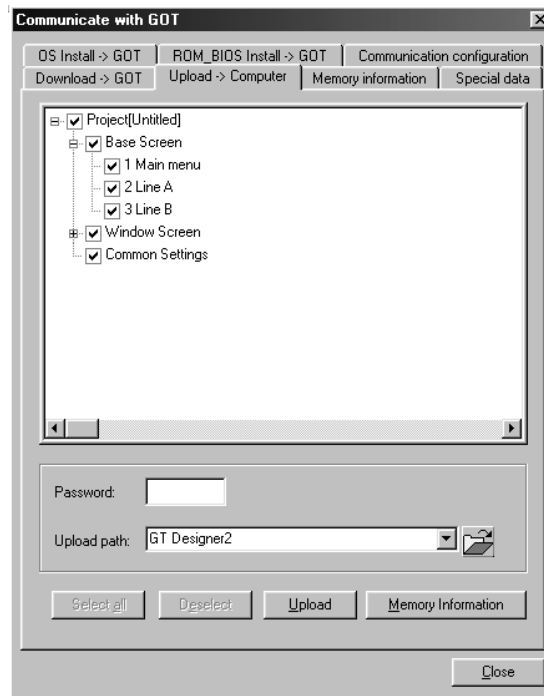
\*1 It is displayed after the built-in memory is obtained.



## 5.2.3 Uploading

When the ROM\_BIOS or the OS is installed to the GOT, monitor data of the built-in memory are deleted. To backup the monitor data, upload and save them temporarily in the PC hard disk. The uploading method is as follows:

- 1 Click the [Communication] → [To/From GOT].
- 2 The setting dialog box appears. Make settings referring to the description below. After setting, click the **Upload** button to start upload.



Communicate with GOT dialog box (Upload→Computer tab)

Item	Description	A	F
Project configuration tree	Configuration of the obtained monitor data is displayed in a tree. Right click the mouse to "Select All" or "Unselect".	○	○
Password*1	When the password for upload is set, input the password. Each input is displayed as "*".	○	○
Upload path	Storage location of the uploaded monitor data is set. (Up to 5 historical data specified in the past are retained.) When data is uploaded in default (GT Designer2), the uploaded data are read into the currently open GT Designer2.	○	○
<b>Upload</b>	Items checked in the project configuration tree are uploaded. When the project configuration tree is not displayed, all monitor data of the GOT built-in memory are uploaded. If the space of the upload destination is not sufficient, uploading is interrupted.	○	○
<b>Memory Information</b>	Built-in memory information of the GOT is obtained.	○	○

\*1 For the setting method of password for upload, refer to the following manual.

 GT Designer2 Version2 Reference Manual

## 5.2.4 Installing ROM\_BIOS

---

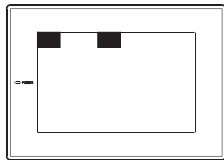


- (1) Data installed in the GOT  
When the ROM\_BIOS is installed, the monitor data, special data and OS in the GOT are deleted.  
Upload them (copy OS to PC card) when these data are required to backup.
- (2) During installation of ROM\_BIOS  
Once the ROM\_BIOS installation is started, it cannot be interrupted.  
Do not turn OFF the power of the GOT/PC or unplug the communication cable to interrupt. Otherwise, the GOT may become inoperable.

### <GOT recovery method>

If the GOT goes down due to the operation above, install the system program again by the following procedure:

- ① Turn OFF the GOT.
- ② Remove the communication module/board and option module mounted on GOT.  
For GOT provided a communication unit, remove the communication cable.
- ③ Turn ON the GOT while pressing two locations shown below on the GOT at the same time.

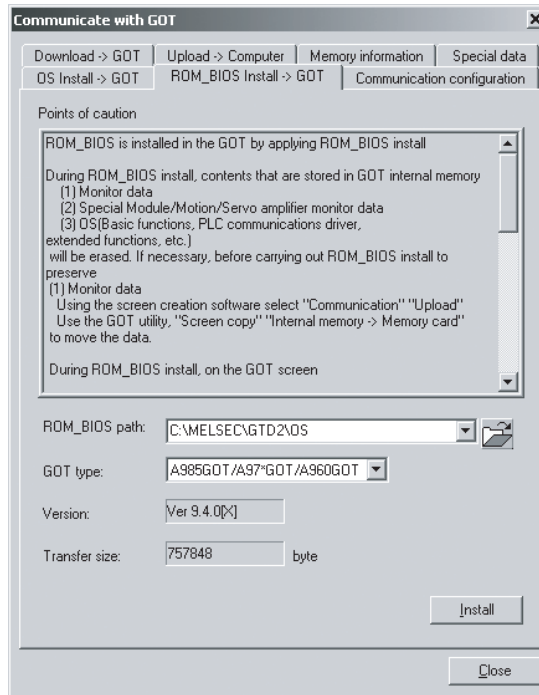


- ④ Message "Reinstall the ROM\_BIOS/OS" appears on the GOT.
- ⑤ Complete installation according to the GOT instruction.

If the GOT is not recovered by the above method, contact your local Mitsubishi service center or representative.

Installation method of the ROM\_BIOS is shown below:

- 1 Click the [Communication] → [To/From GOT].
- 2 The setting dialog box appears. Click the ROM\_BIOS Install → GOT tab. Refer to the following description for setting.  
After setting, click the  button to start installation.



Communicate with GOT dialog box (ROM\_BIOS Install→GOT tab)

Item	Description	A	F
Points of caution	Points of caution are described for installation of the ROM_BIOS. Be sure to read this before installation.	○	×
ROM_BIOS path	Path (drive, folder) that stores the ROM_BIOS to be installed is specified. (Up to 5 historical data specified in the past are retained.)	○	×
GOT type	The type of GOT to which the ROM_BIOS is installed is selected.	○	×
Version	Version of the ROM_BIOS is displayed.	○	×
Transfer size	Size of the ROM_BIOS to be transferred is displayed.	○	×
<input type="button" value="Install"/>	The ROM_BIOS is installed.	○	×

- 3 After installation, reset the GOT to start rewriting the ROM\_BIOS.  
Never turn OFF the power of the GOT or press the reset switch during rewriting. The GOT may become inoperable.

```
Set UP ROM_BIOS Ver *.* **
Step Status
1.Erase .....OK
2.Weite .....OK
3.Verify .....Doing
⚠注意：電源を切らないで下さい。
リセットボタンを押さないで下さい。
Don't turn off the power supply.
Don't push the reset button.
```

GOT screen during rewriting ROM\_BIOS

- 4 After rewriting, message "Cycle power on unit" appears.
- 5 After resetting, transfer the OS or the monitor data.

### **Remark**

#### Installing ROM\_BIOS of old version

When the GOT is reset to install the old version ROM\_BIOS, the following message appears and the GOT stops. (The old version ROM\_BIOS cannot be rewritten.)

```
ROM_BIOS setup Ver1.1.0[B]
⚠注意：電源を切らないで下さい。
リセットボタンを押さないで下さい。

Don't turn off the power supply.
Don't push the reset button.
ROM_BIOS Not Rewriterble.
GOT stopped
Please install operating system.
```

When the message appears, transfer the OS or monitor data with the above screen status.

## 5.2.5 Installing OS

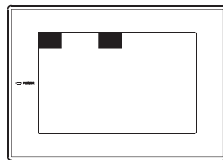


- (1) Data installed in the GOT  
When the OS is installed, the monitor data and special data in the GOT are deleted.  
If the data must be retained, upload them in advance.
- (2) During installation of OS  
The OS installation, it can be interrupted. (Reinstallation of the OS is required.)  
Do not turn OFF the power of the GOT/PC or unplug the communication cable.  
Otherwise, the GOT may become inoperable.

### <GOT recovery method>

If the GOT goes down due to the operation above, install the system program again by the following procedure:

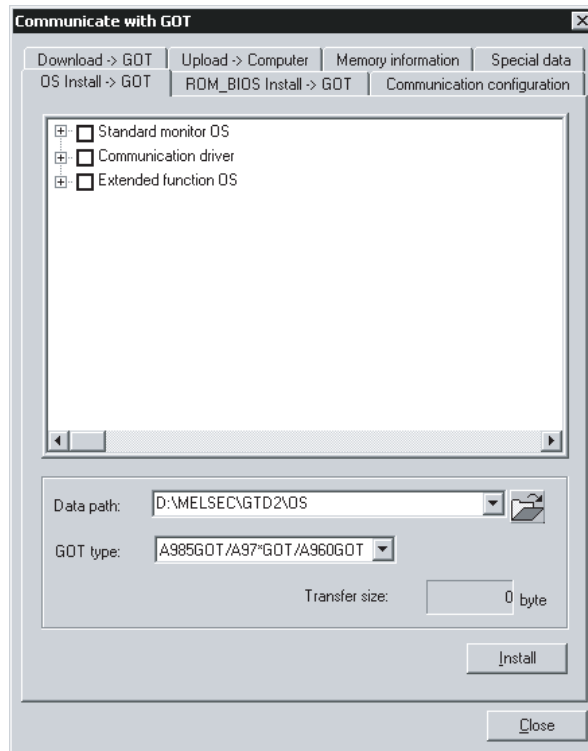
- ① Turn OFF the GOT.
- ② Remove the communication module/board and option module mounted on GOT.  
For GOT provided a communication unit, remove the communication cable.
- ③ Turn ON the GOT while pressing two locations shown below on the GOT at the same time.



- ④ Message "Reinstall the ROM\_BIOS/OS" appears on the GOT.
- ⑤ Complete installation according to the GOT instruction.

Installation method of the OS (standard monitor OS, communication driver, extended function OS) is shown below:

- 1 Click the [Communication] → [To/From GOT].
- 2 The setting dialog box appears. Click the OS Install -> GOT tab. Refer to the following descriptions for setting.  
After setting, click the  button to start installation.



Communicate with GOT dialog box (OS Install → GOT tab)

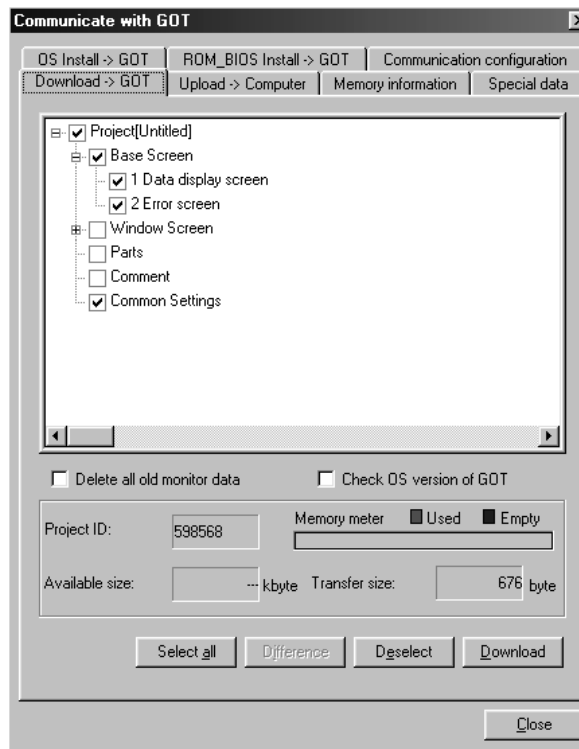
Item	Description	A	F
Function tree	The standard monitor OS, communication driver and extended function OS are displayed in a tree. Check the desired item for installation. Refer to the following for details of items to be selected.		
	Standard monitor OS  Section 5.1.1 <b>2</b> Standard monitor OS	○	×
	Communication driver  Section 5.1.1 <b>3</b> Communication driver		
	Extended function  Section 5.1.1 <b>4</b> Extended function OS		
Data path	Path (drive, folder) that stores the OS to be installed is specified. (Up to 5 historical data specified in the past are retained.)	○	×
GOT type	The type of GOT to which the OS is installed is selected.	○	×
Transfer size	Size of the OS selected in the "function tree" is displayed.	○	×
<input type="button" value="Install"/>	The OS is installed.	○	×

## 5.2.6 Downloading monitor data

### 1 Downloading monitor data

Downloading method of the monitor data is shown below:

- 1 Click the [Communication] → [To/From GOT].
- 2 The setting dialog box appears. Refer to the following descriptions for setting. After setting, click the  button to start installation.



Communicate with GOT dialog box (Download→GOT tab)

Item	Description	A	F
Project configuration tree	The project configuration tree is displayed. Check the desired item for downloading. Right click the mouse to "Select All" or "Unselect".	<input type="radio"/>	<input type="radio"/>
Delete all old monitor data	After deleting the monitor data already downloaded to the GOT, this is checked to download this monitor data.	<input type="radio"/>	<input type="radio"/>
Project ID	Project ID is displayed.	<input type="radio"/>	<input type="radio"/>
Available size	When the built-in memory information has the memory information of the GOT, the available size for a user is displayed.	<input type="radio"/>	<input type="radio"/>
Check OS version of GOT	Check this to check the basic OS version of the GT Designer2 and the basic OS version installed on the GOT. If the basic OS version installed on the GOT is older than the GT Designer2 OS version, a message to prompt reinstallation of the OS appears in downloading.	<input type="radio"/>	<input checked="" type="radio"/>
Memory meter	When the built-in memory information has the memory information of the GOT, the available size for the user is displayed as a meter.	<input type="radio"/>	<input type="radio"/>
Transfer size	Size of the monitor data selected in the project configuration tree is displayed.	<input type="radio"/>	<input type="radio"/>
<input type="button" value="Select All"/>	All items in the project configuration tree are selected.	<input type="radio"/>	<input type="radio"/>

Item	Description	A	F
<input type="checkbox"/> Difference	If download has been performed during editing, items subsequently changed in the project configuration tree are checked. After selection, click the Download button to download the edited items only. When data has not been downloaded, this is not available. When the project is closed, Difference cannot be selected.	<input type="radio"/>	<input type="radio"/>
<input type="checkbox"/> Deselect	All items selected in the "project configuration tree" are deselected. (Items for common settings are not deselected.)	<input type="radio"/>	<input type="radio"/>
<input type="checkbox"/> Download	The monitor data is downloaded.	<input type="radio"/>	<input type="radio"/>

## 2 Downloading only the changed monitor data.

Use of this function during monitor data debugging or editing, only the screens and settings changed since the last download can be selected.

The download time can be reduced by downloading only the selected items.

- 1 Click the [Communication] → [To/From GOT] menu.
- 2 As the setting dialog box appears, click the Project Download → GOT tab.
- 3 Click the  Difference button.

Only the changed items will be selected.

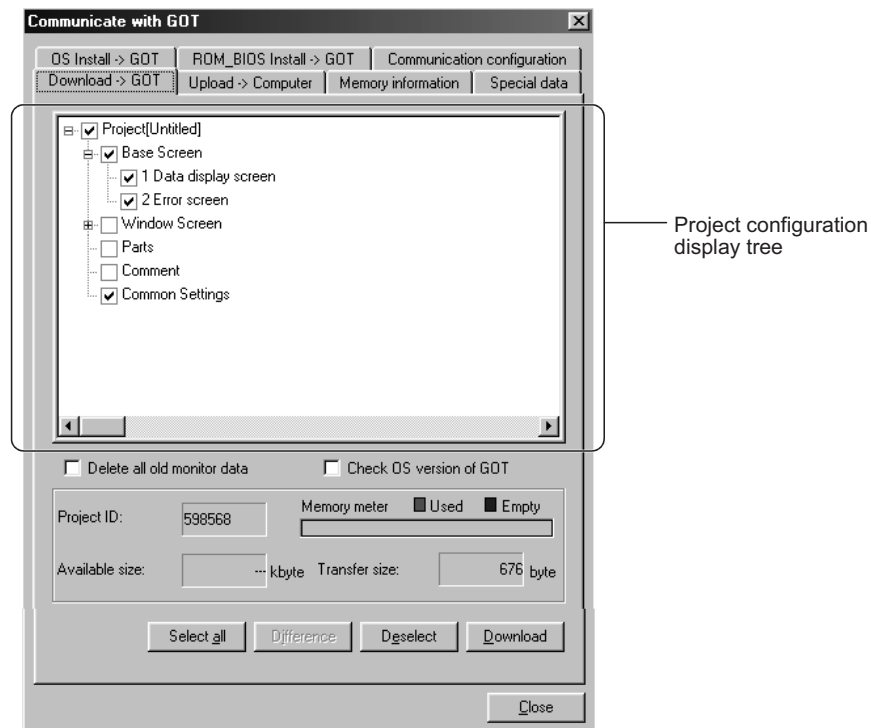
After that, the settings of the items to be downloaded and the other setting items can be changed.

Refer to the following (previous) section for the setting items of the dialog box.

### Section 5.2.6 Downloading monitor data

When downloading only the changed data, note that if the [Delete all old monitor data] check box has been checked, only the changed items will be within the download destination folder after download.

Communicate with GOT dialog box (Project Download → GOT tab)



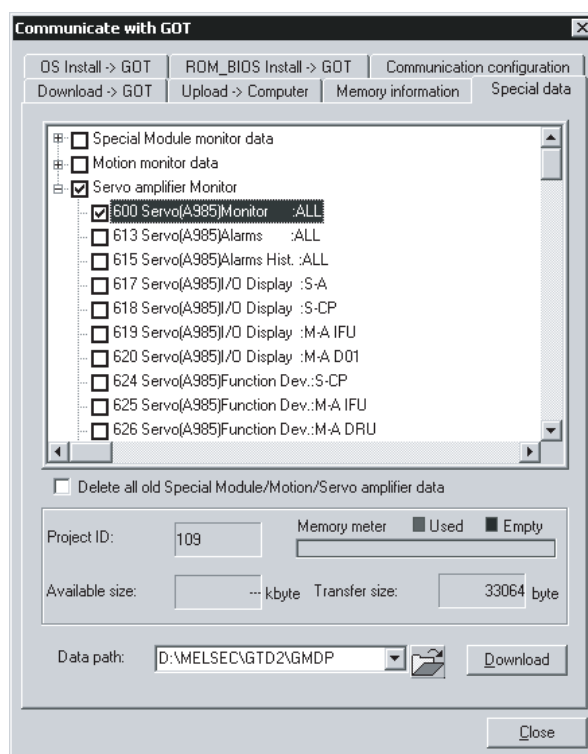
- 4 Click the  Download button to start downloading.



## 5.2.7 Downloading special data

Downloading method of the special data is shown below:

- 1 Click the [Communication] → [To/FromGOT].
- 2 The setting dialog box appears. Click the Special data tab and refer to the following descriptions for setting.  
After setting, click the  button to start downloading.



Communicate with GOT dialog box (Special data tab)

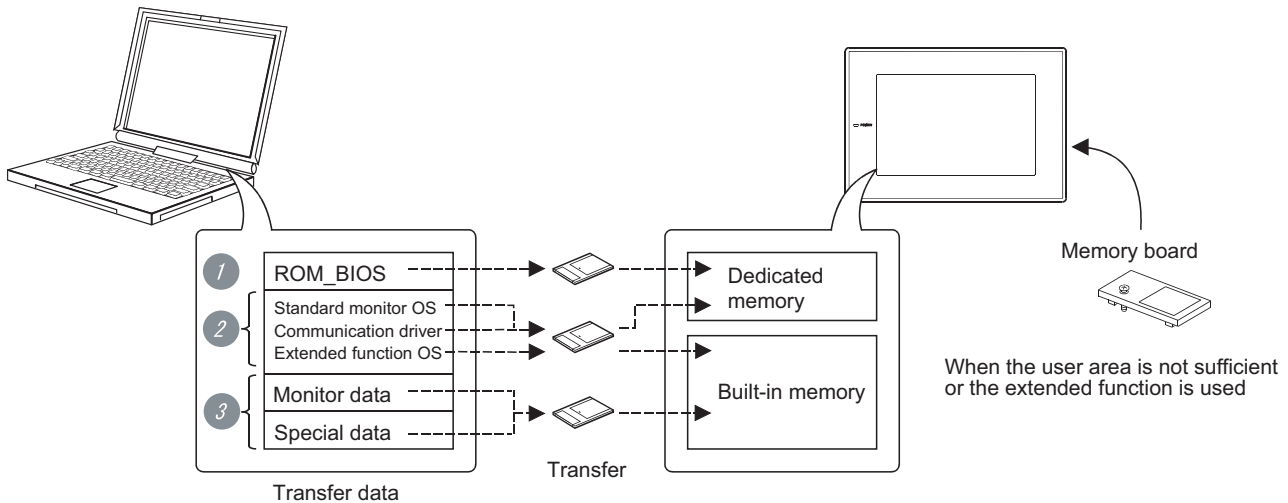
Item	Description	A	F
Special data tree	The special data are displayed in a tree. Check the desired item for downloading. Right click the mouse to "Select All" or "Unselect".	○	×
Delete all old Special module/ Motion/Servo amplifier data	After deleting the special data already downloaded to the GOT, this is checked to download this special data.	○	×
Project ID	Project ID is displayed.	○	×
Available size	When the built-in memory information has the memory information of the GOT, the available size for the user is displayed.	○	×
Memory meter	When the built-in memory information has the memory information of the GOT, the available size for the user is displayed as a meter.	○	×
Transfer size	Size of the monitor data selected in the project configuration tree is displayed.	○	×
Data path	Path (drive, folder) that stores the project of the special data to be downloaded is specified. (Up to 5 historical data specified in the past are retained.)	○	×
<input type="button" value="Download"/>	The special data is downloaded.	○	×

# 5.3 Transferring Data Using Memory Card

Data transfer method with the memory card is described.  
 With a memory card, it is not necessary to carry a PC or cable.  
 The data transfer time is faster than that of the communication with the RS-232 cable.\*1  
 The working time can be reduced.

## 1 Procedures

Data is transferred with the procedures below.



- \*1 Reference value.....For screen data (589,572 bytes (30 screens)), approx. 55 sec. for memory card and approx. 5 min. for RS-232 cable
- \*2 When the GOT-F900 Series is used, data cannot be transferred with the memory card.
- \*3 Data in ② and ③ can be transferred at the same time depending on the memory card size.

- ① ROM\_BIOS ..... ➔ Section 5.3.1 Installing ROM\_BIOS
- ② Standard monitor OS, communication driver and extended function OS  
 ..... ➔ Section 5.3.2 Transferring OS, monitor data and special data
- ③ Monitor data and special data  
 ..... ➔ Section 5.3.2 Transferring OS, monitor data and special data

### Remark

Monitor data transfer to memory card

To transfer monitor data from the PC to the memory card, the project must be opened on the GT Designer2.  
 Other data than the monitor data can be transferred even if the project is not opened on the GT Designer2.

## 2 Precautions

- (1) Module mounted on the GOT  
When data are transferred, remove the communication module/board and extended module mounted on the GOT.  
When the GOT has the built-in communication interface, remove the communication cable.
- (2) Detailed explanation and category set on project or screen  
Detailed explanation and category set on the project or screen are not downloaded to the GOT.  
After downloading, they are not saved when they are uploaded again from the GOT.
- (3) Transfer method of monitor data to memory card  
Be sure to transfer the monitor data from the GT Designer2 to the memory card.  
If data is copied with Explorer of the PC, the GOT cannot check the data in the memory card.
- (4) Data in GOT/Memory card  
When the same data as the data to be downloaded is already present in the GOT/Memory card, it is overwritten in downloading.
- (5) Memory card format  
Format the memory card before use.  
The following format methods are available:
  - (a) Format with PC (SRAM type, flash PC card)  
Format the memory card on the PC satisfying the conditions below:
    - 1) The PCMCIA card slot is available.
    - 2) Windows® 98, Windows® Me or Windows® 2000 is installed.  
(The memory card cannot be formatted with Windows NT® 4.0.)
  - (b) Format with self-diagnosis (memory card check) of utility menu  
Only the SRAM type memory card can be used.  
Refer to the GOT-A900 Series operating manual (Extended • Option Functions Manual) for details of the utility menu.
- (6) Transfer (write) time to memory card  
The transfer time from GT Designer2 to memory is affected by the PC environment. Therefore, it may take longer until the data transfer will be completed, depending on the memory card and the OS (Windows) in the PC.



### Formatting with PC

Format the Memory card (SRAM type memory card, Flash PC card) for the GOT using FAT16 type

To make the SRAM type memory card recognized on Windows® 98, statement must be added to config.sys.

Refer to Help of Windows® 98 for details.

## 5.3.1 Installing ROM\_BIOS

---

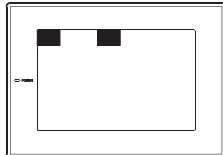


- (1) Using memory card  
Do not put other data in the memory card which is used to install the ROM\_BIOS.
- (2) Installed data in GOT  
When install ROM\_BIOS, the monitor data in GOT, special data and OS are deleted.  
Upload them (copy OS to PC card) when these data are required to backup.
- (3) Installing ROM\_BIOS  
The ROM\_BIOS installation, it cannot be interrupted.  
Do not turn OFF the power of the GOT/PC or unplug the communication cable.  
Otherwise, the GOT may become inoperable.

### <GOT recovery method>

If the GOT is inoperable due to the operation above, install the system program again with the procedure below:

- ① Turn OFF the GOT.
- ② Remove the communication module/board and option module mounted on GOT.  
For GOT provided a communication unit, remove the communication cable.
- ③ Turn ON the GOT while pressing two locations shown below on the GOT at the same time.



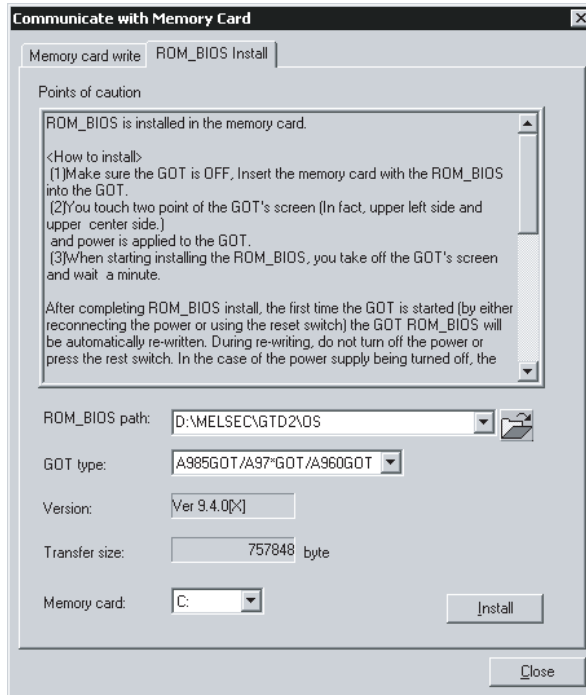
- ④ Message "Reinstall the ROM\_BIOS/OS" appears on the GOT.
- ⑤ Complete installation according to the GOT instruction.

If the GOT is not recovered with the above method, contact your local Mitsubishi service center or representative.

Installation method of the ROM\_BIOS is shown below:

**1** Write method to memory card

- 1 Click the [Communication] → [To Memory Card].
- 2 The setting dialog box appears. Refer to the following description for setting. After setting, click the **Install** button to start saving on the memory card.

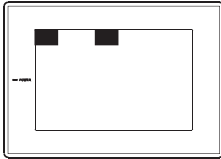


Communication with GOT dialog box (ROM\_BIOS Install tab)

Item	Description	A	F
Points of caution	Points of caution are described for installation of the ROM_BIOS. Be sure to read this before installation.	○	×
ROM_BIOS path	Path (drive, folder) that stores the ROM_BIOS to be installed is specified. (Up to 5 historical specified in the past are retained.)	○	×
GOT type	The type of GOT to which the ROM_BIOS is installed is selected.	○	×
Version	Version of the ROM_BIOS is displayed.	○	×
Transfer size	Size of the ROM_BIOS to be transferred is displayed.	○	×
Memory card	Drive assigned to the PCMCIA slot is selected.	○	×
<b>Install</b>	The ROM_BIOS is installed on the memory card. After installation, the dialog box (Completed) appears.	○	×

## 2 Installation method on GOT

- 1 Turn OFF the GOT.
- 2 Remove the communication module/board and option module mounted on GOT.  
For GOT provided a communication unit, remove the communication cable.
- 3 Mount the memory card to the GOT.
- 4 Turn ON the memory card access switch.
- 5 Turn ON the power while pressing two locations shown below on the GOT screen.



- 6 Message "The system will be initialized" appears on the GOT. The ROM\_BIOS is installed.
- 7 After installation, message "Cycle power on unit" appears on the GOT.
- 8 After resetting, the ROM\_BIOS is automatically started rewriting.  
Never turn OFF the power of the GOT or press the reset switch during rewriting.

```
Set UP ROM_BIOS Ver*. **  
Step Status  
1.Erase ..... OK  
2.Weite ..... OK  
3.Verify ..... Doing  
△注意：電源を切らないで下さい。  
リセットボタンを押さないで下さい。  
Don't turn off the power supply.  
Don't push the reset button.
```

GOT screen during rewriting ROM\_BIOS

- 9 After rewriting, message "Cycle power on unit" appears on the GOT.
- 10 After resetting, transfer the OS or the monitor data.

### **Remark**

#### Installing ROM\_BIOS of old version

When the GOT is reset to install the old version ROM\_BIOS, the message below appears and the GOT stops. (The old version ROM\_BIOS cannot be rewritten.)

```
ROM_BIOS setup Ver1.1.0[B]  
△注意：電源を切らないで下さい。  
リセットボタンを押さないで下さい。  
Don't turn off the power supply.  
Don't push the reset button.  
ROM_BIOS Not Rewriterble.  
GOT stopped  
Please install operating system.
```

When the message appears, transfer the OS or the monitor data with the above screen status.

## 5.3.2 Transferring OS, monitor data and special data

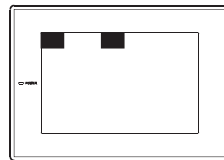


- (1) Data installed in the GOT  
When the OS is installed, the monitor data and special data in the GOT are deleted.  
If the data must be retained, upload them in advance.
- (2) During installation of OS  
The OS installation, it can be interrupted. (Reinstallation of the OS is required.)  
Do not turn OFF the power of the GOT/PC or unplug the communication cable.  
Otherwise, the GOT may become inoperable.

### <GOT recovery method>

If the GOT is inoperable due to the operation above, install the system program again with the procedure below:

- ① Turn OFF the GOT.
- ② Remove the communication module/board and option module mounted on GOT.  
For GOT provided a communication unit, remove the communication cable.
- ③ Turn ON the GOT while pressing two locations shown below on the GOT at the same time.

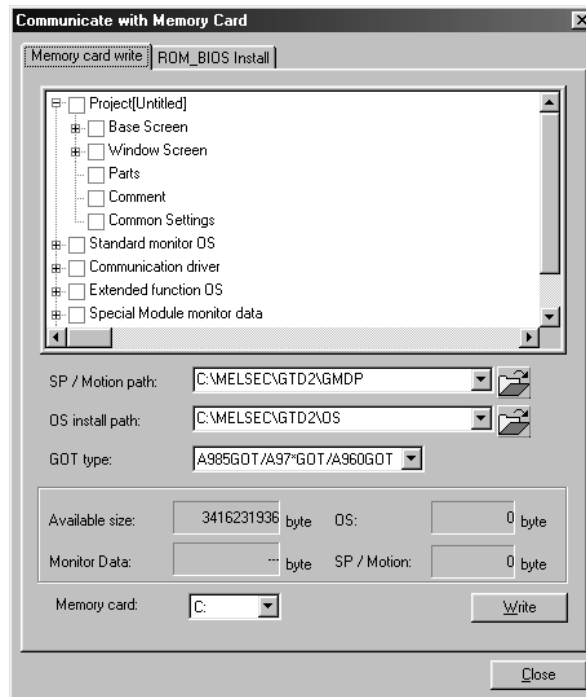


- ④ Message "Reinstall the ROM\_BIOS/OS" appears on the GOT.
- ⑤ Complete installation according to the GOT instruction.

Transfer method of the OS, monitor data and special data is shown below:

## 1 Write method to memory card

- 1 Click the [Communication] → [To Memory Card].
- 2 The setting dialog box appears. Refer to the following descriptions for setting. After setting, click the **Write** button to start writing to the memory card.



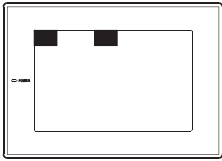
Communicate with Memory Card dialog box (Memory card write tab)

Item	Description	A	F
Project configuration tree	The project configuration tree is displayed in a tree. Check the desired item for downloading. Right click the mouse to "Select All" or "Unselect".	<input type="radio"/>	<input checked="" type="checkbox"/>
SP/Motion path	Path (drive, folder) that stores the data to be installed is specified. (Up to 5 historical data specified in the past are retained.)	<input type="radio"/>	<input checked="" type="checkbox"/>
OS install path		<input type="radio"/>	<input checked="" type="checkbox"/>
GOT type	The type of GOT to which the data is transferred is selected.	<input type="radio"/>	<input checked="" type="checkbox"/>
Available size	When the built-in memory information has the memory information of the GOT, the available size for the user is displayed.	<input type="radio"/>	<input checked="" type="checkbox"/>
Monitor data	When the built-in memory information has the memory information of the GOT, the data size used for each data is displayed.	<input type="radio"/>	<input checked="" type="checkbox"/>
OS		<input type="radio"/>	<input checked="" type="checkbox"/>
SP/Motion		<input type="radio"/>	<input checked="" type="checkbox"/>
Memory card	Drive assigned to the PCMCIA slot is selected.	<input type="radio"/>	<input checked="" type="checkbox"/>
<b>Write</b>	Data are written on the memory card.	<input type="radio"/>	<input checked="" type="checkbox"/>



## 2 Installation method on GOT

- 1 Turn OFF the GOT.
- 2 Remove the communication module/board and option module mounted on GOT.  
For GOT provided a communication unit, remove the communication cable.
- 3 Mount the memory card to the GOT.
- 4 Turn ON the memory card access switch.
- 5 Turn ON the power while pressing two locations below on the GOT screen.




- 6 Message "Monitor data is installed" appears on the GOT. The OS and the monitor data are installed.



### Downloading monitor data and special data

The monitor data and the special data can be downloaded with the GOT utility (screen & OS copy).

Refer to the manual below for details of the GOT utility:

 GOT-A900 Series Operating Manual (Extended • Option Functions Manual)

## 5.4 Error Message for Data Transfer

### 1 Communication setting (☞ Section 5.2.1 Setting communication)

Error No.	Error message	Error definition and cause	Corrective action
—	Invalid communication port is using.	The communication port has not been set.	Set the "Communication port" to the port used for connection of the communication cable to the GOT.

### 2 Built-in memory (☞ Section 5.2.2 Getting built-in memory information)

Error No.	Error message	Error definition and cause	Corrective action
—	Memory information for deleting is not selected.	Deletion item is not selected from the built-in memory.	Select the deletion item from the built-in memory.

### 3 Upload → PC (☞ Section 5.2.3 Uploading)

Error No.	Error message	Error definition and cause	Corrective action
0285	Password Error	The input password is incorrect.	Input the correct password.
—	Invalid folder is specified. Please specify the correct folder.	Invalid upload destination folder (e.g. non-existing folder) is specified.	Specify the valid upload destination folder.

### 4 ROM\_BIOS install → GOT (☞ Section 5.2.4 Installing ROM\_BIOS)

Error No.	Error message	Error definition and cause	Corrective action
0289	GOT type error	The GOT type setting is incorrect.	Select the same "GOT type" as the GOT to be used.
—	Effective ROM_BIOS is not existed in the specified folder. Please specify the correct folder.	Valid ROM_BIOS folder is not present in the specified folder.	Specify the valid ROM_BIOS folder.

### 5 OS install → GOT (☞ Section 5.2.5 Installing OS)

Error No.	Error message	Error definition and cause	Corrective action
0289	GOT type error	The GOT type is incorrect.	Select the same "GOT type" as the GOT for installation of the OS.
—	OS is not selected for Installing.	Item to be installed is not selected.	Select the item in the "function tree".
—	7 or more memories cannot be selected from the extended function OS. Please reduce to a maximum of 6 memoies.	The extended function OS to be installed exceeds the number of required memories (6) that can be installed on the GOT.	Select the extended function OS to be installed so that the number of the required memories may be within 6. (☞ Section 5.1.1 <b>4</b> Extended function OS)
—	Effective OS is not existed in the specified folder. Please specify the correct folder.	The valid OS file is not found in the specified folder.	Specify the valid OS folder.
—	Installing extended function OS is in conflict with already installed. Please install again after deleting the installed function.	The selected function is competing with the function already installed on the GOT. They cannot be operated at the same time on the GOT. (e.g. MELSEC-A ladder monitor and MELSEC-Q ladder monitor)	Delete the function installed on the GOT with the "built-in memory information" and reinstall it. (☞ Section 5.2.2 Getting built-in memory information)

Error No.	Error message	Error definition and cause	Corrective action
—	If the selected OS is installed, the number of allowable extended function OS memories is exceeded. Please reduce to a maximum of 6 memories.	There is no space on the GOT to install the selected extended function OS.	Check the extended function OS installed on the GOT with the "built-in information". Select the item so that the equivalent number of the required memories may be within 6 including the extended function OS to be installed. (☞ Section 5.2.2 Getting built-in memory information) (☞ Section 5.1.1 <b>4</b> Extended function OS)
—	The version of ROM_BIOS installed in the GOT is not compatible with the CNC monitor and the KANA KANJI (JPN) extended OS. Please install a more up to date ROM_BIOS version.	The ROM_BIOS installed in the GOT is not compatible with the CNC monitor and the KANA KANJI (JPN).	Install the ROM_BIOS compatible with the CNC monitor and the KANA KANJI (JPN). (☞ Section 5.1.1 <b>1</b> ROM_BIOS)

\* When the extended function OS that uses two or more required memories is installed, the extended function OS may not be installed with the action above.  
 If it cannot be installed, delete all extended function OS installed on the GOT with the "built-in memory information" and reinstall the extended function OS again.



## 6 Download → GOT (☞ Section 5.2.6 Downloading monitor data)

Error No.	Error message	Error definition and cause	Corrective action
0015	Please make sure of transferring data size.	The GOT built-in memory space runs out during download. Further data cannot be downloaded.	Check items written to the GOT with the "built-in memory information". Delete items written to the GOT and download the data again. (☞ Section 5.2.2 Getting built-in memory information) Add more memory to the built-in memory of the GOT. (Mounting memory board/using-M3 type)
0270	Transfer size error	Since the data size to be downloaded is larger than the GOT user area size, the data cannot be downloaded.	Check the user area size with the "built-in memory information" and download the data again. (☞ Section 5.2.2 Getting built-in memory information) Add the GOT memory. (Mounting memory board/Using-M3 type)



## 7 Special data (☞ Section 5.2.7 Downloading special data)

Error No.	Error message	Error definition and cause	Corrective action
—	Special Module/Motion/Servo amplifier Monitor Module Data is not selected.	The special data to be downloaded is not selected.	Select the special data to be downloaded.
—	Effective Special Module/Motion/Servo amplifier monitor data is not existed in the specified folder. Please specify the correct folder.	The valid special data file is not present in the specified folder.	Specify the folder that has the valid special data.

## 8 Communication

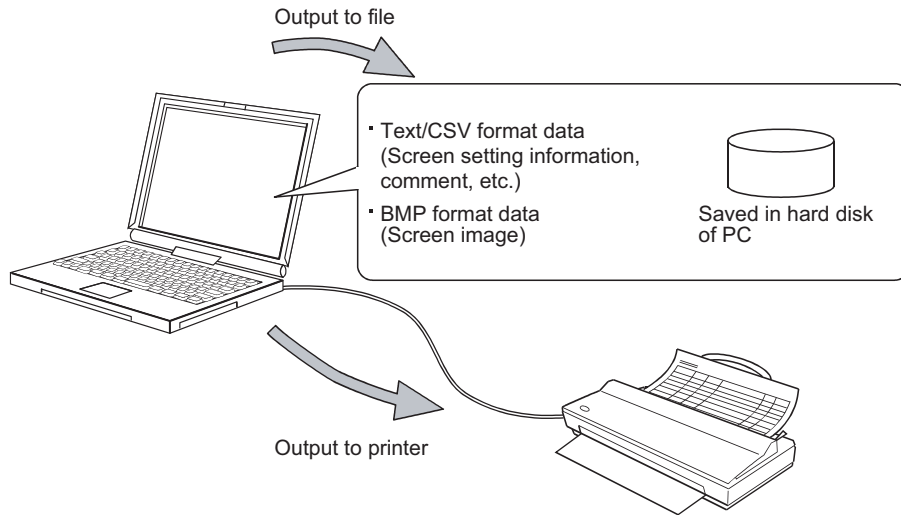
Error No.	Error message	Error definition and cause	Corrective action
0008 to 0014	Please make sure of communicatoin.	Transfer data with the GOT has an error.	Check the cable.
0259	Timeout error	The cable is unplugged. The cable is broken.	Check the cable.
		The GOT is not responding.	Check the GOT condition.
		Communication with the GOT is unstable. An error has occurred in communication.	Set the lower "transmission speed" in the "communication configuration" than the current value. (  Section 5.2.1 Setting communication)
0260	Port open error	Non-existing communication port is set.	Set the port that connects the communication cable to the GOT to the "communication port" of the "communication configuration". (  Section 5.2.1 Setting communication)
0263	Recieve error	Data cannot be received from the GOT. Data received from the GOT has an error.	Check the cable.
0264	Send error	Data cannot be transmitted to the GOT.	Check the cable.
0289	GOT type error	With the communication dialog for the GOT-A900 Series, communication with non-GOT-A900 Series is performed.	Connect the GOT-A900 Series.
		With the communication dialog for the GOT-F900 Series, communication with non-GOT-F900 Series is performed.	Connect the GOT-F900 Series.

## 9 Memory card ( Section 5.3.2 Transferring OS, monitor data and special data)

Error No.	Error message	Error definition and cause	Corrective action
0288	Create Directory Error	The drive where the memory card is set is not specified.	Select the drive where the memory card is set in "Memory card".
		The memory card is write protected.	Disable the write protect of the memory card.
—	OS is not selected for Installing.	The item to be installed is not selected.	Select the item to be installed in the "project configuration tree".
—	7 or more memories cannot be selected from the extended function OS. Please reduce to a maximum of 6 memoies.	The extended function OS to be installed exceeds the number of required memories (6) that can be installed on the GOT.	Select the extended function OS to be installed so that the number of the required memories may be within 6. (  Section 5.1.1 <b>4</b> Extended function OS)
—	CNC monitor and KANA KANJI (JPN) extended OS are compatible with ROM_BIOS Ver 9.2.2[W] or later. When installing to the GOT, please check that the ROM_BIOS is Ver 9.2.2[W] or later Continue writing. OK?	The left message is always displayed when [CNC monitor] or [KANA KANJI (JPN)] is selected in the [Project configuration tree].	Check the ROM_BIOS version installed within the GOT. (  Section 5.1.1 <b>1</b> ROM_BIOS)

# 6. PRINTING PROJECT/FILE OUTPUT

Project settings or screen image created on the GT Designer2 can be output to a file or printer. The data output to a file can be used for various documents after editing with a commercially available word processor software.



## Print setting

- Papers are printed in the portrait mode.
- Font and font size for printing cannot be changed.
- The header information (date, file name) are automatically printed when output to a printer.

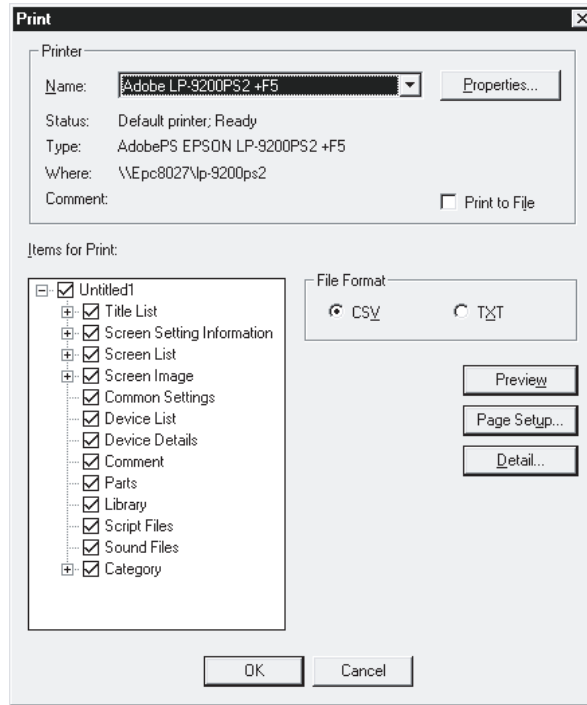
## 6.1 Printing method


### 6.1.1 Setting method

- 1 Select the [Project] → [Print].
- 2 The print setting dialog box appears. Refer to the following description for setting.

## 6.1.2 Setting items

Setting items for printing are described.

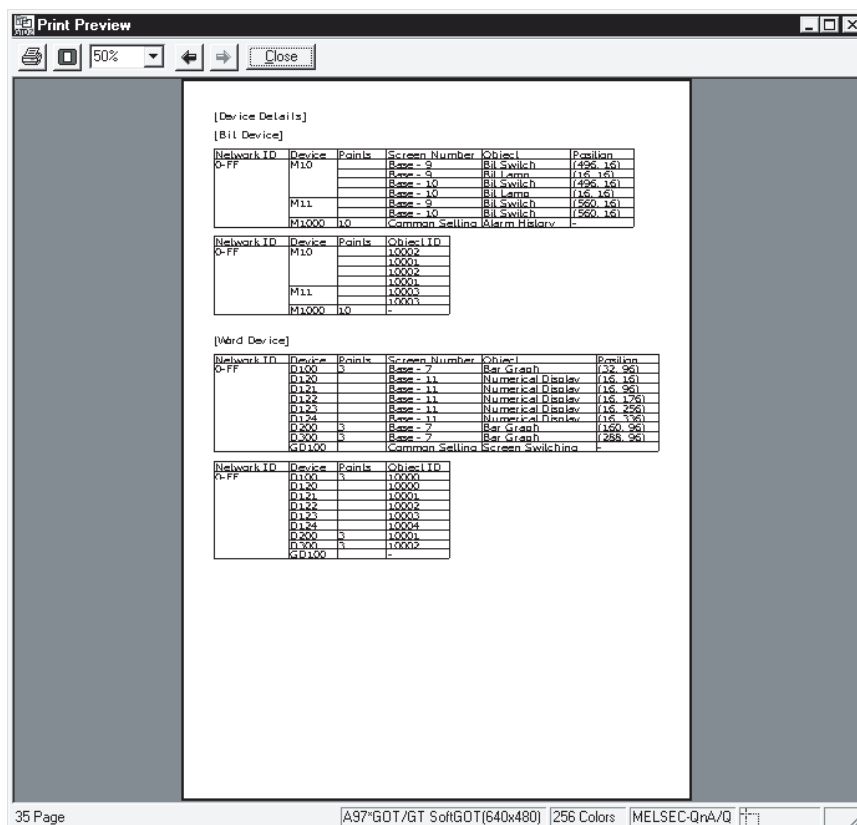


Item		Description	A	F
Printer	Name	Select the printer for printing. To make basic settings of the printer, click the <b>Properties</b> button. Printer setting varies depending on the printer driver of Windows.	<input type="radio"/>	<input type="radio"/>
	Print to file	Save the data in a file without printing from the printer. Check [Print to file] and click the <b>OK</b> button. The Save as dialog box is displayed. Set the file target.	<input type="radio"/>	<input type="radio"/>
Items for print		Select the items to be printed. Refer to the following for the print image of each item:  Section 6.2 Printing example	<input type="radio"/>	<input type="radio"/>
File format		When data are written to files, select the file format (CSV/TXT).	<input type="radio"/>	<input type="radio"/>
Preview *1		Preview in printing is displayed.	<input type="radio"/>	<input type="radio"/>
Page setup *2		Set the page or screen image to be printed.	<input type="radio"/>	<input type="radio"/>
Detail *3		Set each screen's details and select the device used for printing.	<input type="radio"/>	<input type="radio"/>
Print		Outputs the data to the printer or file based on the settings.	<input type="radio"/>	<input type="radio"/>
Close		Closes the dialog box without printing.	<input type="radio"/>	<input type="radio"/>

Refer to the next page for details of \*1 to \*3.

\*1 Print preview

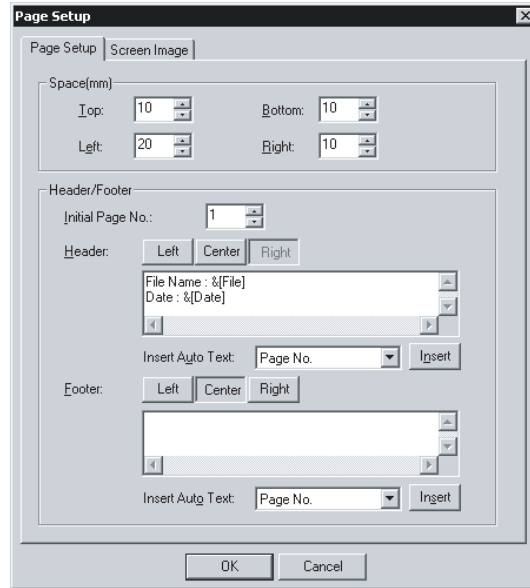
Each icon of print preview is described.



Item	Description	A	F
(Print)	Printing is performed.	<input type="radio"/>	<input type="radio"/>
(One page)	The entire page is displayed.	<input type="radio"/>	<input type="radio"/>
(Zoom)	The display image is enlarged/reduced.	<input type="radio"/>	<input type="radio"/>
(Previous, Next)	Image on the previous/next page is displayed.	<input type="radio"/>	<input type="radio"/>
(Close)	Print Preview is closed.	<input type="radio"/>	<input type="radio"/>

\*2 Page Setup

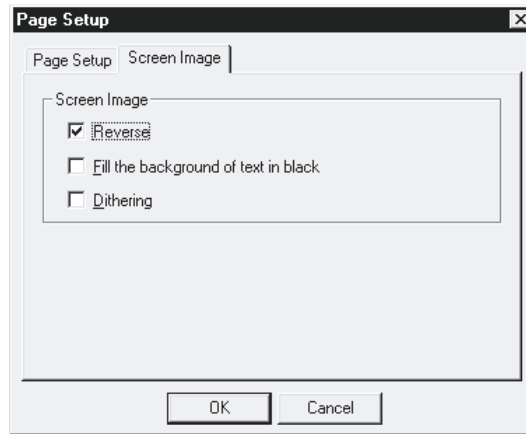
(1) Page Setup tab



Item	Description	A	F																
Space	Set the upper, lower, left and right margins in mm (0 mm to 100 mm)	<input type="radio"/>	<input type="radio"/>																
Initial page no.	Set the initial page number, to be used during printing.	<input type="radio"/>	<input type="radio"/>																
Display position	Each display position for headers/footers can be registered. The position button for the character being registered for display will be highlighted.	<input type="radio"/>	<input type="radio"/>																
Header/footer edit text box	Input/edit printed headers/footers. Comments or auto-text can be input to headers/footers. (Headers/footers have a maximum of two lines.)	<input type="radio"/>	<input type="radio"/>																
Insert Auto Text	<p>The selected auto text will be inserted into the header/footer. Select the auto-text at the combo box and insert using the pushbutton. Auto text can also be input from the PC keyboard.</p> <table border="1"> <thead> <tr> <th>Auto text</th> <th>Keyboard input</th> </tr> </thead> <tbody> <tr> <td>Page No.</td> <td>&amp;[Page]</td> </tr> <tr> <td>Date</td> <td>&amp;[Date]</td> </tr> <tr> <td>Time</td> <td>&amp;[Time]</td> </tr> <tr> <td>GOT Type</td> <td>&amp;[GOT]</td> </tr> <tr> <td>PLC Type</td> <td>&amp;[PLC]</td> </tr> <tr> <td>Project Title</td> <td>&amp;[Project]</td> </tr> <tr> <td>File Name</td> <td>&amp;[File]</td> </tr> </tbody> </table>	Auto text	Keyboard input	Page No.	&[Page]	Date	&[Date]	Time	&[Time]	GOT Type	&[GOT]	PLC Type	&[PLC]	Project Title	&[Project]	File Name	&[File]	<input type="radio"/>	<input type="radio"/>
Auto text	Keyboard input																		
Page No.	&[Page]																		
Date	&[Date]																		
Time	&[Time]																		
GOT Type	&[GOT]																		
PLC Type	&[PLC]																		
Project Title	&[Project]																		
File Name	&[File]																		



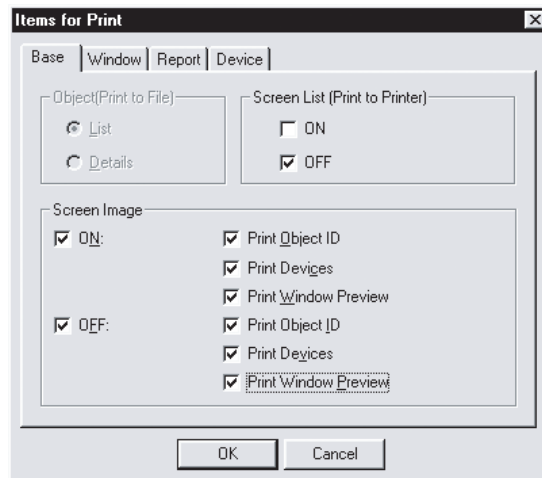
(2) Screen Image tab



Item	Description	A	F
Reverse	Check this item to output the screen image with black and white inverted.	<input type="radio"/>	<input type="radio"/>
Fill the background of text in black	Check this item to output the text in the black background.	<input type="radio"/>	<input type="radio"/>
Dithering	Check this item to convert the screen image into black and white, apply monochrome dithering to the image and output it.	<input type="radio"/>	<input type="radio"/>

\*3 Detail

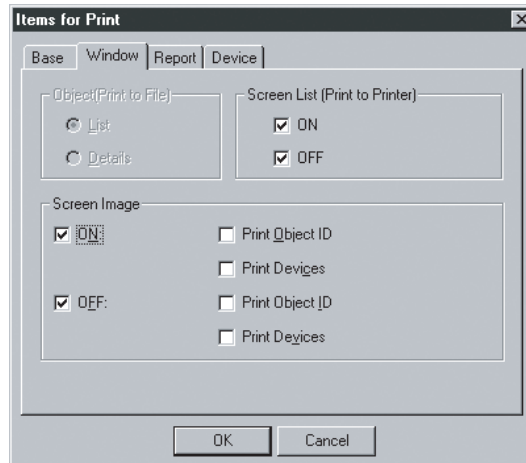
(1) Base tab



Base tab

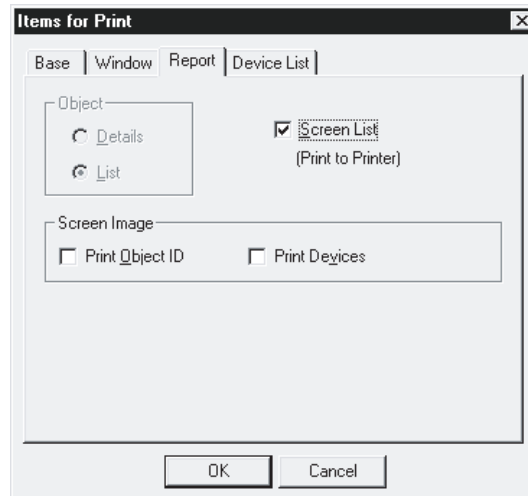
Item	Description	A	F
Object (Print to File)	Select whether the object setting to be output in [List] or [Details] format for the screen setting check. Selectable only for output to file. (Fixed to [List] for output to printer.)	<input type="radio"/>	<input type="radio"/>
Screen List	Set the image (ON/OFF) to be output to a screen list. When both are checked, both of ON and OFF screen images are output. When neither of them is checked, no screen list is output.	<input type="radio"/>	<input type="radio"/>
Screen Image	Set the image (ON/OFF) to be output to a screen image. When both are checked, both of ON and OFF screen images are output. When neither of them is checked, no screen image is output. In addition to a normal screen image, the screen image on which the object ID or devices are put can be output.	<input type="radio"/>	<input type="radio"/>
Print Object ID	Outputs the screen image on which the object ID is put.	<input type="radio"/>	<input type="radio"/>
Print Devices	Outputs the screen image on which devices are put.	<input type="radio"/>	<input type="radio"/>
Print Window Preview	Outputs the screen image on which windows are put.	<input type="radio"/>	<input type="radio"/>

(2) Window tab



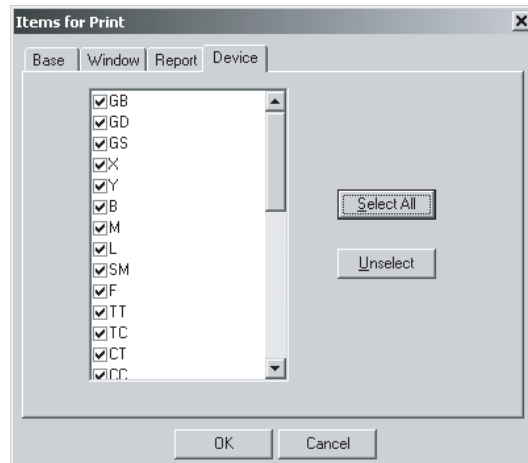
Item	Description	A	F
Object (Print to file)	Select whether the object setting to be output in [List] or [Details] format for the screen setting check. Selectable only for output to file. (Fixed to [List] for output to printer.)	<input type="radio"/>	<input type="radio"/>
Screen List	Set the image (ON/OFF) to be output to a screen list. When both are checked, both of ON and OFF screen images are output. When neither of them is checked, no screen list is output.	<input type="radio"/>	<input type="radio"/>
Screen Image	Set the image (ON/OFF) to be output to a screen image. When both are checked, both of ON and OFF screen images are output. When neither of them is checked, no screen image is output. In addition to a normal screen image, the screen image on which the object ID or devices are put can be output.	<input type="radio"/>	<input type="radio"/>
Print Object ID	Outputs the screen image on which the object ID is put.	<input type="radio"/>	<input type="radio"/>
Print Devices	Outputs the screen image on which devices are put.	<input type="radio"/>	<input type="radio"/>

(3) Report tab



Item	Description	A	F
Object (Print to file)	Select the object setting to be output in [List] or [Details] format. Selectable only for output to file. (Fixed to [List] for output to printer.)	<input type="radio"/>	<input type="radio"/>
Screen List	Check this item to output a screen list. (Output ON images.)	<input type="radio"/>	<input type="radio"/>
Screen Image	Outputs a screen image. In addition to a normal screen image, the screen image on which the object ID or devices are put can be output.	<input type="radio"/>	<input type="radio"/>
Print Object ID	Outputs the screen image on which the object ID is put.	<input type="radio"/>	<input type="radio"/>
Print Devices	Outputs the screen image on which devices are put.	<input type="radio"/>	<input type="radio"/>

(4) Device tab



Item	Description	A	F
Device	Select a device name to be printed in a device list or device details.	<input type="radio"/>	<input type="radio"/>
Select All	Selects all devices.	<input type="radio"/>	<input type="radio"/>
Unselect	Unselects all devices.	<input type="radio"/>	<input type="radio"/>

# 6.2 Printing example

## 6.2.1 Printer output

### Title list

Each screen title is printed as shown below.

File Name : C:\WINDOWS\full\monitor\_data.GTD  
Date : 2003-07-03

[Base Screen Title List]

1	Main menu
2	Line A
3	Line B
4	Line C
5	Line D
6	Alarm history
7	Line ABC Graph
8	Tank
9	Line A Status
10	Line B Status
11	Base 11
12	Base 12
13	Base 13
14	Base 14
15	Base 15
16	Base 16

[Window Screen Title List]

1	The window for restoration
---	----------------------------

[Report Screen Title List]

1	For the number output of product
---	----------------------------------

### Screen setting information

Setting items in each screen are printed as shown below.

File Name : C:\WINDOWS\full\monitor\_data.GTD  
Date : 2003-07-03

Base Screen1

[Base Screen Details]

Screen Name	Main menu
Size	640X480
Detailed Explanation	-

[Key Window Setting]

Key Window Same as the project setting

[Object List]

	Device	Coordinates	Object ID
Goto Screen Switch	-	32,128	10000
	-	176,128	10001
	-	320,128	10002
	-	464,128	10003
Time Display	-	528,432	10004

### Screen list

List of created screens is printed as shown below.

File Name : C:\WINDOWS\full\monitor\_data.GTD  
Date : 2003-07-03

[Base Screen Image List]

1:Main menu[ON]	2:Line A[ON]	3:Line B[ON]	4:Line C[ON]
5:Line D[ON]	6:Alarm history[ON]	7:Line ABC Graph[ON]	8:Tank[ON]
9:Line A Status[ON]	10:Line B Status[ON]	11:Base 11[ON]	12:Base 12[ON]
13:Base 13[ON]	14:Base 14[ON]	15:Base 15[ON]	16:Base 16[ON]

### Screen image

Each screen image is printed as shown below.

File Name : C:\WINDOWS\full\monitor\_data.GTD  
Date : 2003-07-03

Base1:Main menu  
[Screen size]640X480

[ON]

[OFF]

\*1 The number of screens displayed on the screen image view is fixed to 16 screens (4 x 4) per page.

### Common Setting

Details of common setting are printed as shown below.

File Name : C:\WINDOWS\full\monitor\_data.GTD  
Date : 2003-07-03

[Alarm History]

Mode	Historical
Number of Alarms to Monitor	10
Watch Cycle(100ms)	20
Detailed Alarm Display Type	Not Display
Data Type	Bit
Device No.	Continuous
Comment No.	Continuous
Detailed Display No.	--
Number of Alarms Occurred	--
History Clear	--
Store to PC Card(Min)	--
Store to File Format	--
Delete oldest alarm occurrences	No
History Print	No
Title	No
Print : Date	--
Print : Time	--
Print : Message	--
Print : Cumulative Time	--
Print : Occur Frequency	--
Print : State	--
Status : Printout Occurred	--
Status : Printout Restored	--
Status : Printout Checks	--
Lines	61
Columns	119
Top Space	0
Left Space	0

Device	Alarm Range	Comment No.	Detail	RST	RST Value	Mail
M100	1	0	--	0	--	No
M101	2	0	--	0	--	No
M102	3	0	--	0	--	No
M103	4	0	--	0	--	No
M104	5	0	--	0	--	No
M105	6	0	--	0	--	No
M106	7	0	--	0	--	No
M107	8	0	--	0	--	No
M108	9	0	--	0	--	No
M109	10	0	--	0	--	No

### Device List

List of set devices is printed as shown below.

File Name : D:\MELSEC\GT02\Example\900\Introduction\aaa.GTD  
Date : 2005-07-23

[Device List]

[GOT Device]

[Word Device]

[GD List]

Device	
0xFF	GD100

[MELSEC-QnAQ, MELDAS C6\*]

[Bit Device]

[X List]

Device	
0xFF	X0070 X0011 X0012 X0013 X0021 X0022 X0023 X0024 X00FF

[M List]

Device	
0xFF	M100 M101 M102 M103 M104 M105 M106 M107 M108 M109 M225 M300 M320

[D List]

Device	
0xFF	D100.D0

### Device Details

Details of set devices are printed as shown below.

File Name : D:\MELSEC\GT02\Example\900\Introduction\aaa.GTD  
Date : 2005-07-23

[Device Details]

[GOT Device]

[Word Device]

[GD Details]

Device	Points	Screen Number	Object	Coordinates	Object ID
0xFF	GD100		Common Setting		

[MELSEC-QnAQ, MELDAS C6\*]

[Bit Device]

[X Details]

Device	Points	Screen Number	Object	Coordinates	Object ID
0xFF	X0010	Base - 1	Bit Lamp	112,176	10002
	X0011	Base - 1	Bit Lamp	170,176	10003
	X0012	Base - 1	Bit Lamp	228,176	10004
	X0013	Base - 1	Bit Lamp	286,176	10005
	X0021	Base - 1	Bit Lamp	344,176	10006
	X0022	Base - 1	Bit Lamp	402,176	10007
	X0023	Base - 1	Bit Lamp	460,176	10008
	X0024	Base - 1	Bit Lamp	518,176	10009
	X00FF	Base - 1	Bit Lamp	576,176	10010

[M Details]

Device	Points	Screen Number	Object	Coordinates	Object ID
0xFF	M100	Base - 1	Bit Lamp	112,256	10011
	M101	Base - 1	Bit Lamp	160,256	10012
	M102	Base - 1	Bit Lamp	208,256	10013
	M103	Base - 1	Bit Lamp	256,256	10014
	M104	Base - 1	Bit Lamp	304,256	10015
	M105	Base - 1	Bit Lamp	352,256	10016
	M106	Base - 1	Bit Lamp	400,256	10017
	M107	Base - 1	Bit Lamp	448,256	10018
	M108	Base - 1	Bit Lamp	496,256	10019
	M109	Base - 1	Bit Lamp	544,256	10020
	M225	Base - 1	Bit Lamp	112,336	10021
	M300	Base - 1	Bit Lamp	160,336	10022
	M320	Base - 1	Bit Lamp	240,336	10023

[D Details]

Device	Points	Screen Number	Object	Coordinates	Object ID
0xFF	D100.D0		Bit Switch	256,36	10001
		Base - 1	Bit Switch	36,46	10000

### Comment

Created comments and their attributes are printed as shown below.

File Name : C:\WINDOWS\full\monitor\_data.GTD  
Date : 2003-07-03

[Comment List]

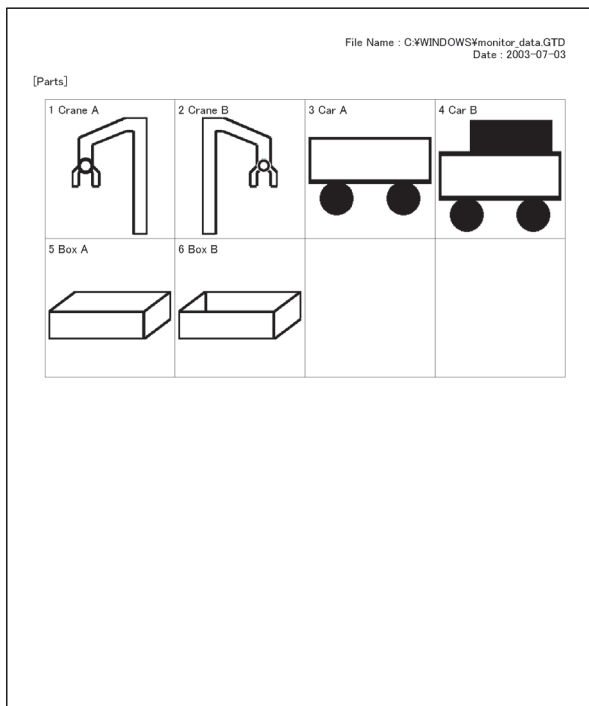
1	Line A stopped.
2	Line B stopped.
3	Line C stopped.
4	Line D stopped.
5	Emergency stop limit switch operated. Check the product.
6	Product limit switch does not operate. Check for presence/absence of the product.
7	Hydraulic pressure of finishing machine 1 is low. Supply hydraulic oil.

1	Text Color :Black/ Reverse No/ Blink : No/ HQFont : No/ Style : Regular
2	Text Color :Black/ Reverse No/ Blink : No/ HQFont : No/ Style : Regular
3	Text Color :Black/ Reverse No/ Blink : No/ HQFont : No/ Style : Regular
4	Text Color :Black/ Reverse No/ Blink : No/ HQFont : No/ Style : Regular
5	Text Color :Red/ Blink : Low/ HQFont : No/ Style : Bold
6	Text Color :Red/ Blink : Low/ HQFont : No/ Style : Bold
7	Text Color :Red/ Blink : Low/ HQFont : No/ Style : Bold

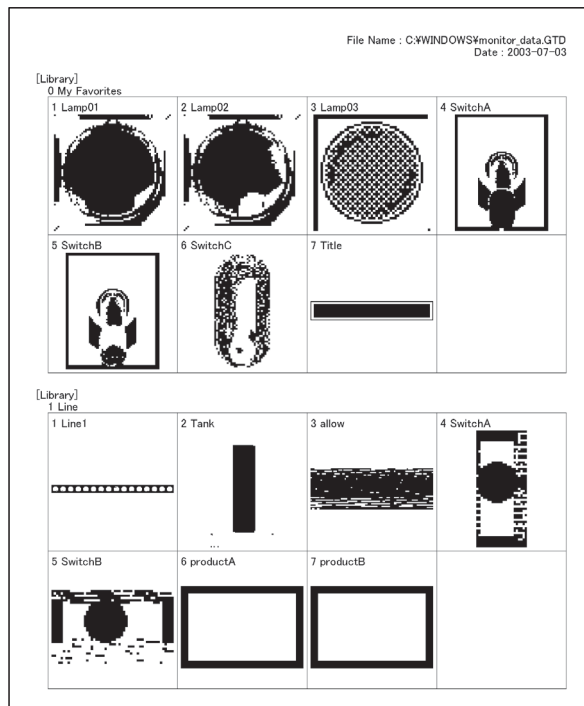
Parts

List of created parts is printed as shown below.



Library

List of My favorites or user-defined libraries is printed as shown below.



Script

List of set script files is printed as shown below.

File Name : C:\WINDOWS\full\monitor\_data.GTD  
Date : 2003-07-03

[Script File]

No.	Comment	Modified	Script File Path
1	Script 1	-	C:/WINDOWS/desktop/script-1.txt
2	Script 2	-	C:/WINDOWS/desktop/script-2.txt
3	Script 3	-	C:/WINDOWS/desktop/script-3.txt
4	Script 4	-	C:/WINDOWS/desktop/script-4.txt

Voice

List of set voice files is printed as shown below.

File Name : C:\WINDOWS\full\monitor\_data.GTD  
Date : 2003-07-03

[Sound Files]

No.	Sound File Path
1	C:\WINDOWS\desktop\monitor_data\Line_A_Sound.wav
2	C:\WINDOWS\desktop\monitor_data\Line_B_Sound.wav
3	C:\WINDOWS\desktop\monitor_data\Line_C_Sound.wav
4	C:\WINDOWS\desktop\monitor_data\Line_D_Sound.wav

## Category

Each category list is printed as shown below.

File Name : C:\WINDOWS\full\monitor\_data.GTD  
Date : 2003-07-03

[Category]

[Switch]

	Screen	Coordinates
Goto Screen Switch	B-3	480,400
Goto Screen Switch	B-4	480,400
Goto Screen Switch	B-5	480,400
Goto Screen Switch	B-7	480,400
Goto Screen Switch	B-9	480,400
Goto Screen Switch	B-1	32,128
Goto Screen Switch	B-1	176,128
Goto Screen Switch	B-1	320,128
Goto Screen Switch	B-1	464,128
Goto Screen Switch	B-10	480,400
Goto Screen Switch	B-2	480,400

[Lamp]

	Screen	Coordinates
Bit Lamp	B-3	16,16
Bit Lamp	B-3	16,80
Bit Lamp	B-3	16,144
Bit Lamp	B-3	16,208
Bit Lamp	B-4	16,16
Bit Lamp	B-4	16,80
Bit Lamp	B-4	16,144
Bit Lamp	B-4	16,208
Bit Lamp	B-5	16,16
Bit Lamp	B-5	16,80
Bit Lamp	B-5	16,144
Bit Lamp	B-5	16,208
Word Lamp	B-16	32,32
Word Lamp	B-16	128,32
Word Lamp	B-16	224,32
Bit Lamp	B-9	480,32
Bit Lamp	B-9	544,32
Bit Lamp	B-9	32,32
Bit Lamp	B-10	480,32
Bit Lamp	B-10	544,32
Bit Lamp	B-10	32,32
Bit Lamp	B-2	16,16
Bit Lamp	B-2	16,80
Bit Lamp	B-2	16,144
Bit Lamp	B-2	16,208

[Others]

	Screen	Coordinates
Numerical Display	B-11	32,16
Numerical Display	B-11	32,96
Numerical Display	B-11	32,176
Numerical Display	B-11	32,256
Numerical Display	B-11	32,336
Numerical Display	B-3	96,16
Numerical Display	B-3	96,80
Numerical Display	B-3	96,144
Numerical Display	B-3	96,208
Rectangle	B-3	256,16
Filled Circle	B-12	80,112
Filled Rectangle	B-12	0,128



## 6.2.2 File output

### 1 Files to be output

In file output, the following files are output to the specified folder.

- (1) Image file (\*\* refers to screen numbers.)
  - (a) Base screen
 

Base ON-**.Bmp	Base OFF-**.Bmp
Base ON object ID-**.Bmp	Base OFF object ID-**.Bmp
Base ON device-**.Bmp	Base OFF device-**.Bmp
  - (b) Window screen
 

Window ON-**.Bmp	Window OFF-**.Bmp
Window ON object ID-**.Bmp	Window OFF object ID-**.Bmp
Window ON device-**.Bmp	Window OFF device-**.Bmp
  - (c) Report, Parts, Library
 

Report-**.Bmp	Parts-**.Bmp
Library**.**.Bmp (First ** shows the library No., and second one shows the template No., respectively)	
- (2) Text file
 

Title list.CSV/TXT	Screen setting information.CSV/TXT
Common setting.CSV/TXT	Device list.CSV/TXT
Device detail.CSV/TXT	Comment list.CSV/TXT
Parts.CSV/TXT	Library.CSV/TXT
Script.CSV/TXT	Voice.CSV/TXT
Category.CSV/TXT	

### Remark

- (1) If a file, which was saved in CSV format once by GT Designer2, is opened by other software, this may change the format settings, and the file may not be correctly displayed.  
In this case, adjust the settings by using the corresponding menu or other of the software.
- (2) If a file, which was saved in TXT format once by GT Designer2, is opened by other software, this may disrupt the settings of tab or space, and the text may appear misaligned.  
In this case, adjust the text poison by adding/deleting tabs or spaces.

### 2 Output image (When set to CSV file format)

The output image (in CSV file format) is shown below:

Title list

Each screen title is output as shown below.

	A	B	C	D	E	F	G	H
1	[Title List]							
2								
3		[Base Screen Title List]						
4		1 Main menu						
5		2 Line A						
6		3 Line B						
7		4 Line C						
8		5 Line D						
9		6 Alarm history						
10		7 Line AEG Graph						
11		8 Tank						
12		9 Line A Status						
13		10 Line B Status						
14		11 Base 11						
15		12 Base 12						
16		13 Base 13						
17		14 Base 14						

Screen setting information

Setting items in each screen are output as shown below.

	A	B	C	D	E	F	G	H
1	[Screen Setting Information]							
2								
3		Base Screen						
4		[Base Screen Details]						
5		Screen Name	Main menu					
6		Size	640x480					
7		Detailed Explanation						
8								
9								
10								
11		[Key Window Setting]						
12		Key Window	Same as the project setting					
13								
14								
15		[Goto Screen Switch]						
16		Object ID	10000					
17		Coordinate	32 128					

### Common Setting

Details of common setting are output as shown below.

	A	B	C	D	E	F	G	H
1	[Project Title]							
2		A line						
3	[ProjectID]							
4		428122						
5	[Author]							
6		Mitsubishi						
7	[Detailed Explanation]							
8								
9	[GOT Type]							
10		A87*GOT/GT SoftGOT(640x480)						
11	[PLC Type]							
12		MELSEC-QnA/Q, MELDAS C6*						

### Device List

List of set devices is output as shown below.

	A	B	C	D	E	F	G	H
1	[Device List]							
2								
3	[GOT Device]							
4								
5	[Word Device]							
6		[GD List]						
7			Device					
8		0-FF	GD100					
9								
10	[MELSEC-QnA/Q, MELDAS C6*]							
11	[Bit Device]							
12		[X List]						
13			Device					
14		0-FF	X0010 X0011 X0012 X0013 X0021 X0022 X0023 X0024 X00FF					
15								
16		[M List]						
17			Device					

### Device Details

Details of set devices are output as shown below.

	A	B	C	D	E	F	G	H
1	[Device Details]							
2								
3	[GOT Device]							
4								
5	[Word Device]							
6		[GD Details]						
7			Device	Points	Screen Number	Object	Coordinates	Object ID
8		0-FF	GD100		Common Setting	Screen Switching	-	-
9								
10	[MELSEC-QnA/Q, MELDAS C6*]							
11	[Bit Device]							
12		[X Details]						
13			Device	Points	Screen Number	Object	Coordinates	Object ID
14		0-FF	X0010		Base - 1	Bit Lamp	112,176	10003
15			X0011		Base - 1	Bit Lamp	170,176	10003
16			X0012		Base - 1	Bit Lamp	228,176	10004
17			X0013		Base - 1	Bit Lamp	286,176	10004

### Comment

Created comments and their attributes are output as shown below.

	A	B	C	D	E	F	G	H
1	[Comment List]							
2								
3			1 Line A stopped					
4			2 Line B stopped					
5			3 Line C stopped					
6			4 Line D stopped					
7			5 Emergency stop limit switch operated. Check the product.					
8			6 Product limit switch does not operate. Check for presence/absence of the product.					
9			7 Hydraulic pressure of finishing machine 1 is low. Supply hydraulic oil.					
10								
11			1 Text Color	Black/ Reverse	Nb/ Blink	Nb/ HqFont	Nb/ Style	Regular
12			2 Text Color	Black/ Reverse	Nb/ Blink	Nb/ HqFont	Nb/ Style	Regular
13			3 Text Color	Black/ Reverse	Nb/ Blink	Nb/ HqFont	Nb/ Style	Regular
14			4 Text Color	Black/ Reverse	Nb/ Blink	Nb/ HqFont	Nb/ Style	Regular
15			5 Text Color	Red/ Blink	Low/ HqFont	Nb/ Style	Bold	Regular
16			6 Text Color	Red/ Blink	Low/ HqFont	Nb/ Style	Bold	Regular
17			7 Text Color	Red/ Blink	Low/ HqFont	Nb/ Style	Bold	Regular

### Parts

List of registered parts is output as shown below.

	A	B	C	D	E	F	G	H
1	[Parts]							
2								
3		1 Crane A						
4		2 Crane B						
5		3 Car A						
6		4 Car B						
7		5 Box A						
8		6 Box B						
9								
10								
11								
12								
13								
14								
15								
16								
17								

### Library

List of registered libraries is output as shown below.

	A	B	C	D	E	F	G	H
1	[Library]							
2								
3	My Favorite							
4		1 Lamp01						
5		2 Lamp02						
6		3 Lamp03						
7		4 Switch A						
8		5 Switch B						
9		6 Switch C						
10		7 Title						
11	1 Line							
12		1 Line 1						
13		2 Tank						
14		3 Allow						
15		4 Switch 1						
16		5 Switch 2						
17								

### Script

List of script files is output as shown below.

	A	B	C	D	E	F	G	H
1	[Script Information]							
2								
3		[Script File]						
4		No.	Comment	Modified	Script File Path			
5		1	Script 1	-	C:\WINDOWS\desktop\script-1.txt			
6		2	Script 2	-	C:\WINDOWS\desktop\script-2.txt			
7		3	Script 3	-	C:\WINDOWS\desktop\script-3.txt			
8		4	Script 4	-	C:\WINDOWS\desktop\script-4.txt			
9								
10								
11								
12								
13								
14								
15								
16								
17								

### Voice

List of registered voice files is output as shown below.

	A	B	C	D	E	F	G	H
1	[Sound Files]							
2								
3		No.	Sound File Path					
4		1	C:\WINDOWS\desktop\p\monitor_data\Line_A_Sound.wav					
5		2	C:\WINDOWS\desktop\p\monitor_data\Line_B_Sound.wav					
6		3	C:\WINDOWS\desktop\p\monitor_data\Line_C_Sound.wav					
7		4	C:\WINDOWS\desktop\p\monitor_data\Line_D_Sound.wav					
8								
9								
10								
11								
12								
13								
14								
15								
16								
17								

### Category

Each category list is output as shown below.

	A	B	C	D	E	F	G	H
1	[Category]							
2								
3	[Switch]							
4			Screen	Coordinates				
5		Goto Screen Switch B-1		32,128				
6		Goto Screen Switch B-1		176,128				
7		Goto Screen Switch B-1		320,128				
8		Goto Screen Switch B-1		464,128				
9		Goto Screen Switch B-2		480,400				
10		Goto Screen Switch B-3		480,400				
11		Goto Screen Switch B-4		480,400				
12		Goto Screen Switch B-5		480,400				
13								
14								
15	[Lamp]							
16			Screen	Coordinates				
17		Bit Lamp	B-2	16,16				

# 7. USING LIBRARY

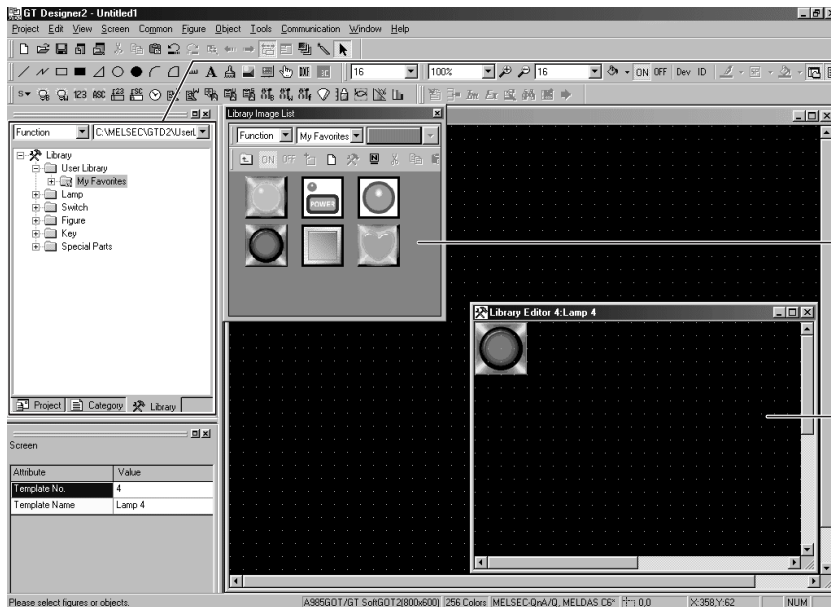
Figures and objects created by the user can be registered as a library. Registered figures and objects can be easily pasted on the screen.

## 7.1 What is Library?

### 7.1.1 What you need to know before using library

#### 1 Screen used for library

In library, registration and readout are performed on the screen below:

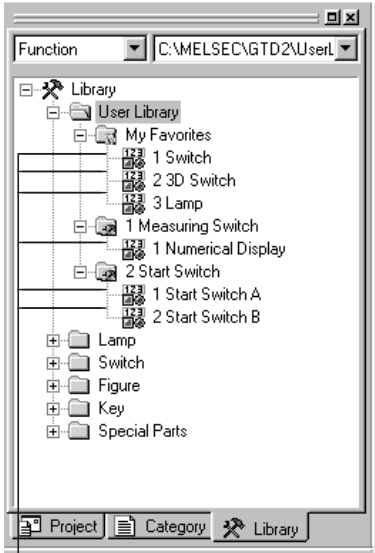


"Library workspace"  
Registered objects or figures are displayed in a tree. To display the library workspace, click the library tab of the workspace.

"Library image view"  
The library can be operated while displaying image of registered objects or figures.

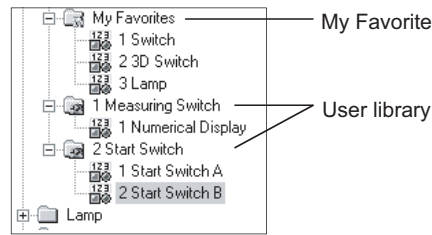
"Library editor"  
Double click the registered objects or figures to edit them with the dedicated editor.

## 2 Library type



Template  
 Figures and objects registered to the library are registered as templates.  
 Templates are registered under any of libraries.

- (1) Library which can be created by a user  
 Objects or figures created by a user can be registered.



(a) My Favorite

Objects or figures registered as "My favorite" are registered on the "My Favorite" toolbars. When frequently used objects/figures are registered on My Favorite toolbars, it is convenient to use them.



(b) User library

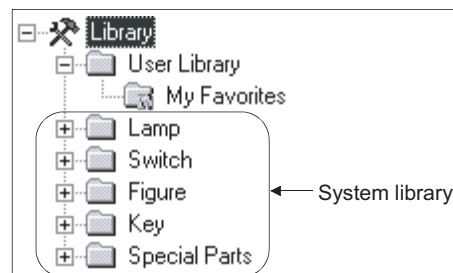
It is a library to register user created figures/objects. When folders are classified for each type, it is convenient to use them.



User-created objects or figures are registered.

(2) System library

The library (not changed by a user) provided by the GT Designer2 has been registered. Retrieving a preset template and arrange it on the screen facilitates settings of lamps or switches. Libraries/templates in the system library cannot be registered, deleted or changed for their attributes.

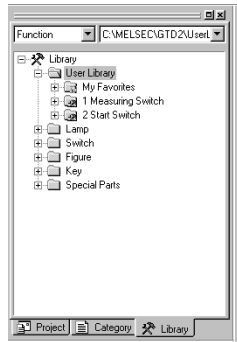


## 3 Number of templates that can be registered

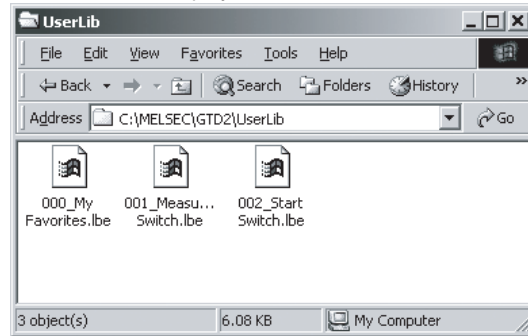
The maximum number of user created libraries except for May Favorites is 250. For one library, up to 200 templates can be registered.

## 4 Library file configuration

Each [User Library] including [My Favorite] is stored as "\*\*\*\*.lbe" in the [User Lib] folder.



Display on Windows

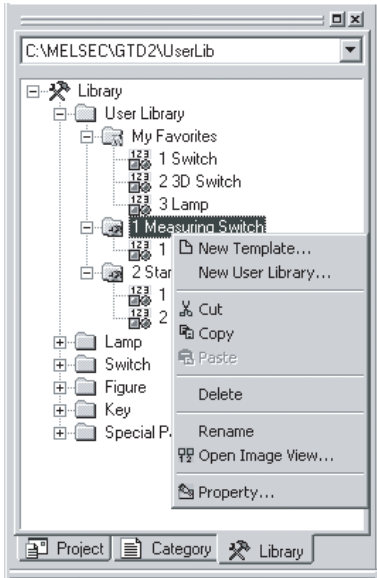


## 7.1.2 Basic operation of library

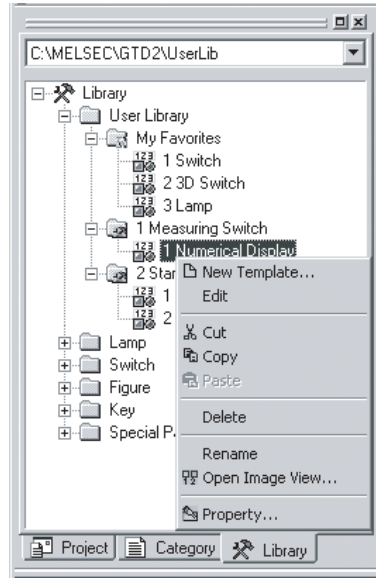
### 1 Basic operation of library workspace

Select the item for operation and right click the mouse to select the setting item.

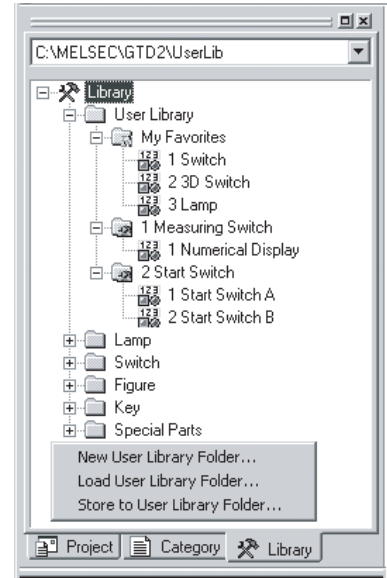
As shown below, the display varies depending on the selected items.



Right click the mouse when the library is selected.



Right click the mouse when the template is selected.

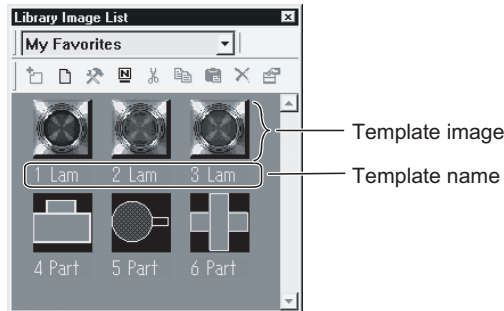


Right click the mouse at a space.

Item	Description	A	F
New Template	New template is added to My Favorite or the user created library.	<input type="radio"/>	<input type="radio"/>
New User Library	New library is added to the user created library.	<input type="radio"/>	<input type="radio"/>
Edit	Registered template is edited/modified with the library editor.	<input type="radio"/>	<input type="radio"/>
Cut	Registered library/template is cut.	<input type="radio"/>	<input type="radio"/>
Copy	Registered library/template is copied.	<input type="radio"/>	<input type="radio"/>
Paste	Cut and registered library/template is pasted to the new library/template.	<input type="radio"/>	<input type="radio"/>
Delete	Registered library/template is deleted.	<input type="radio"/>	<input type="radio"/>
Rename	The name of the registered library/template is changed.	<input type="radio"/>	<input type="radio"/>
Open Image View	Template image is displayed on the [Library image list] screen.	<input type="radio"/>	<input type="radio"/>
Property	The "number" and "name" of the registered library/template is changed.	<input type="radio"/>	<input type="radio"/>
New User Library Folder	A new user library folder is created for the specified path.	<input type="radio"/>	<input type="radio"/>
Load User Library Folder	A user library file is searched in the folder of the specified path. If the user library file exists, open the user library.	<input type="radio"/>	<input type="radio"/>
Store to User Library Folder	The user library folders displayed in the current library workspace are stored in the specified user library folder.	<input type="radio"/>	<input type="radio"/>
Import User Library	Another library file with the currently-edited library data (My Favorites, User Library) is imported.	<input type="radio"/>	<input type="radio"/>

## 2 Basic operation of library image list dialog box

Select the [View] → [Library] → [User Defined Libraries]/[System Libraries] menu.  
The library image list appears.

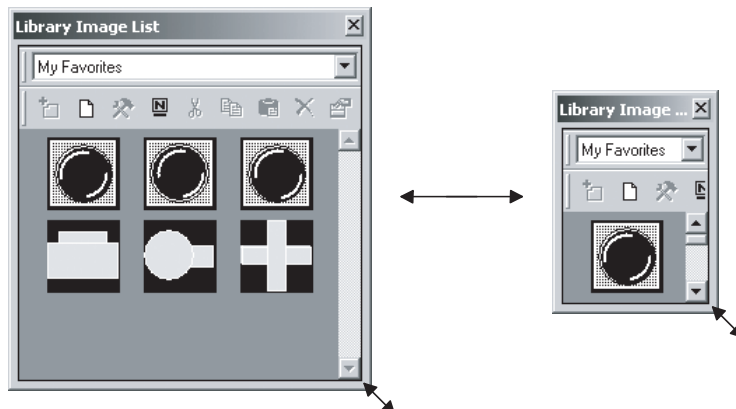


Item	Description	A	F
Library type selection menu	The library type to be displayed is changed.	<input type="radio"/>	<input type="radio"/>
(Register)	Objects or figures selected on the drawing screen are registered on the library.	<input type="radio"/>	<input type="radio"/>
(New Screen)	Template is newly created.	<input type="radio"/>	<input type="radio"/>
(Edit)	Registered template is edited with the library editor.	<input type="radio"/>	<input type="radio"/>
(Name)	Template name is displayed/not displayed.	<input type="radio"/>	<input type="radio"/>
(Cut)	Selected template is cut.	<input type="radio"/>	<input type="radio"/>
(Copy)	Selected template is copied.	<input type="radio"/>	<input type="radio"/>
(Paste)	Template copied with the <input type="text" value="Copy"/> button is pasted.	<input type="radio"/>	<input type="radio"/>
(Delete)	Selected template is deleted.	<input type="radio"/>	<input type="radio"/>
(Property)	Property of a template is displayed.	<input type="radio"/>	<input type="radio"/>



Dialog box displaying

The size of the Library Image List dialog box can be adjusted by a mouse operation.

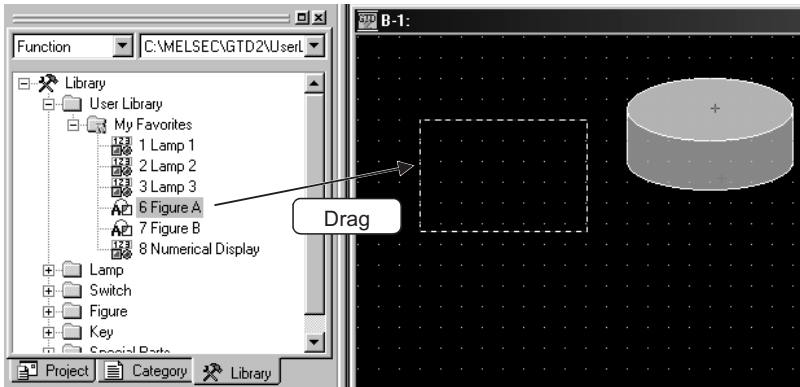


## 7.2 Pasting Objects or Figures from Library

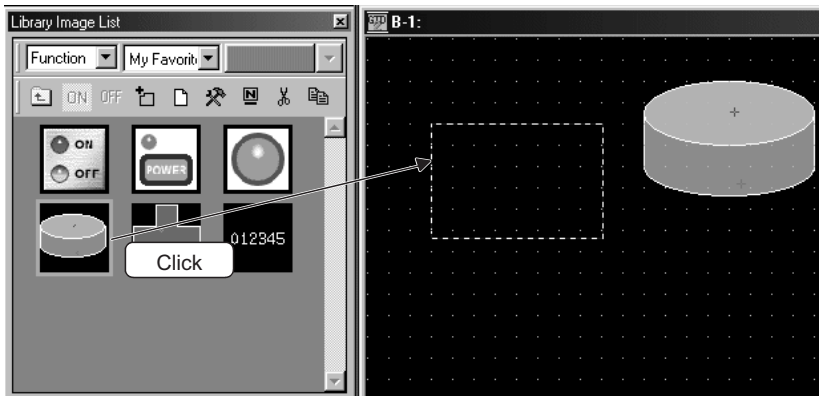
Objects or figures registered to the library are pasted on the screen.

1 Select the template for pasting and paste it on the drawing screen.

(1) Pasting from library workspace



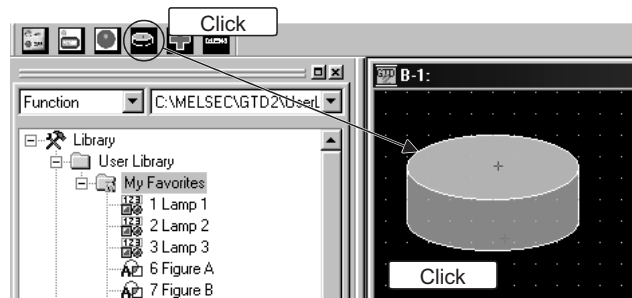
(2) Pasting from library image list



**Hint!**

Loading My Favorite library

Objects or figures registered to the My Favorite library can be read out from the My Favorite icon on the toolbar.



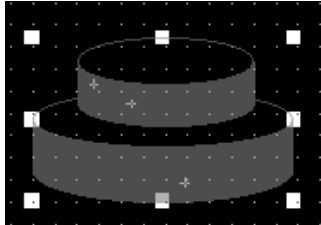


# 7.3 Creating Original Library

## 7.3.1 Registering objects or figures on library

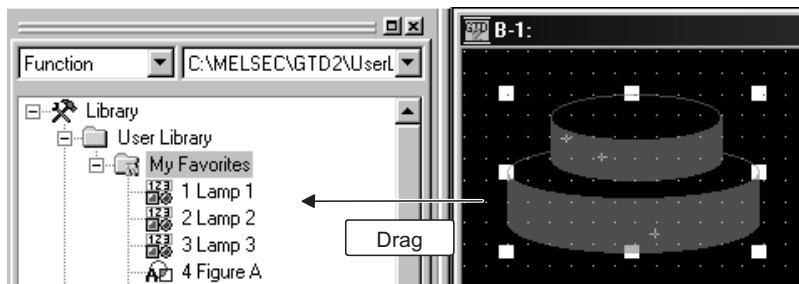
Objects or figures are registered to My Favorite or the user created library.


- 1 Select the object/figure for registration.



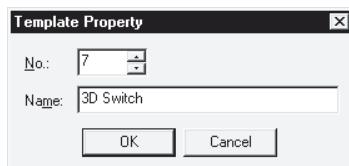
- 2 Perform the following operation:

- (1) Using library workspace  
Drag the object or figure into the workspace.

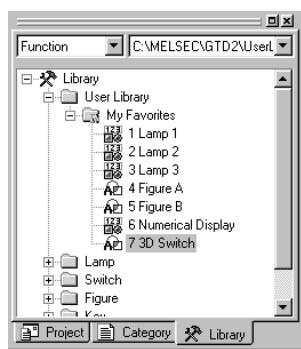


- (2) Using library image list  
Click the  (Register) button.

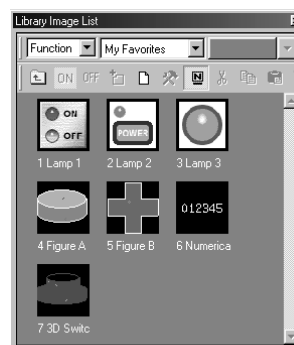
- 3 The template property dialog box appears.  
Input the template number and name and click the **OK** button.



- 4 Registration is completed.



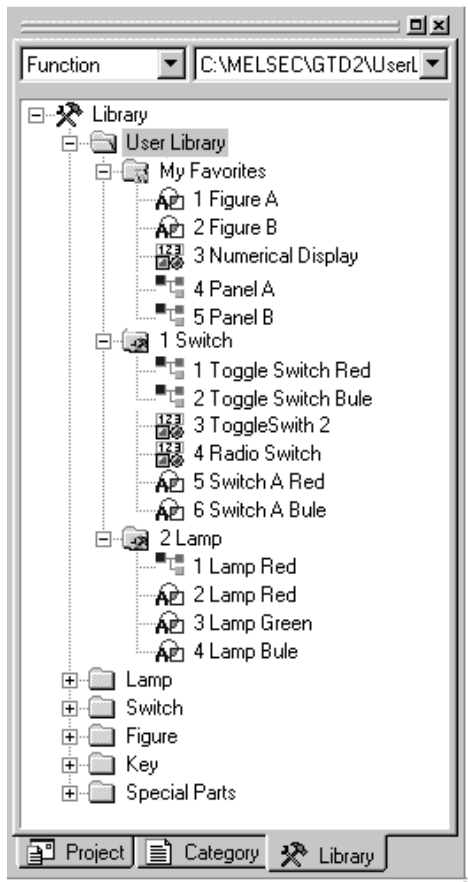
Library workspace






Library image list

## Point

Whether a template includes any objects or not can be identified by an icon display in the library workspace.

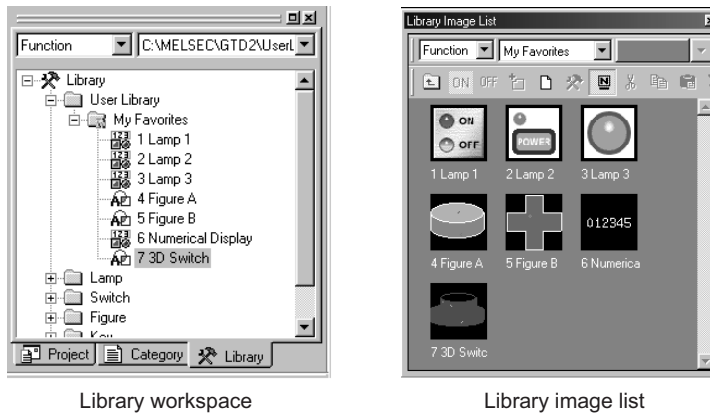


- 1  User libraries created by GT Designer2 of version before 2.07H
- 2  User libraries including objects
- 3  User libraries not including objects



## 7.3.2 Copying registered library/template

User created library or registered template is copied.

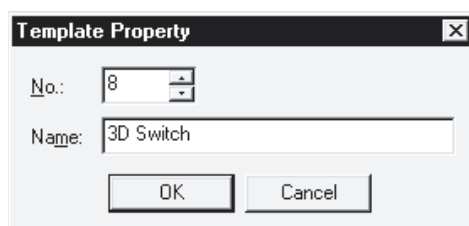
- 1 Select the user created library/template for copying.



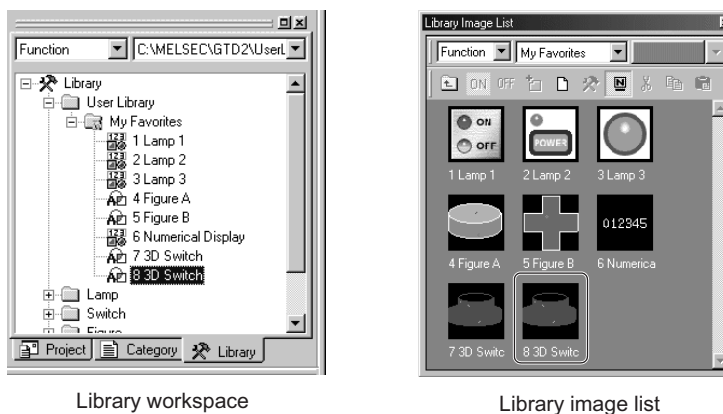
- 2 Perform the following operation:

- (1) Copying in library workspace  
Right click the mouse to select [Copy].  
Right click the mouse again to select [Paste].
- (2) Copying in library image list  
Click  (Copy).  
Then, click  (Paste).

- 3 The library property/template property dialog box appears.  
Set the user created library/template number of copy destination and the library/template name. Click the **OK** button.



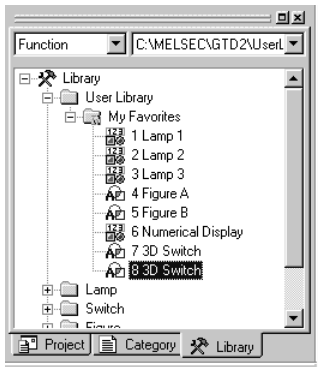
- 4 The selected user created library/template is copied.



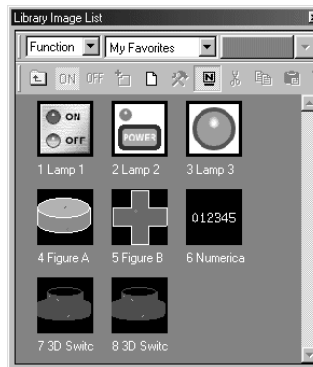
### 7.3.3 Deleting registered library/template

User created library or registered template is deleted.

- 1 Select the user created library/template for deletion.



Library workspace



Library image list

- 2 Perform the operations below:

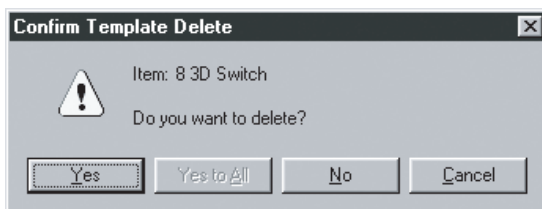
- (1) Deleting in library workspace  
Right click the mouse to select the [Delete] menu.

- (2) Deleting in library image list

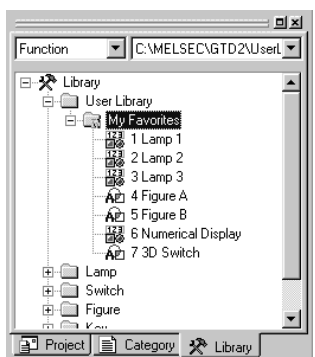
Click the  (Delete) button.

- 3 The confirm template delete dialog box appears.

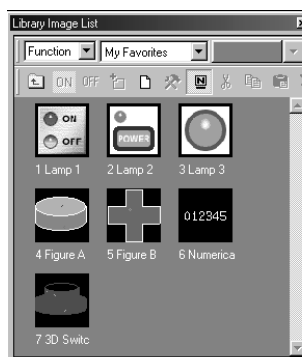
Click the  button.



- 4 The selected user 3D created library/template is deleted.



Library workspace



Library image list



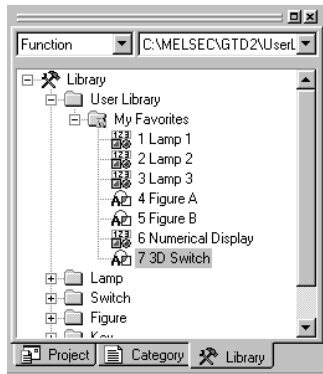
#### Deleting user created library

When the user created library is deleted, note that all templates registered on the library are deleted.

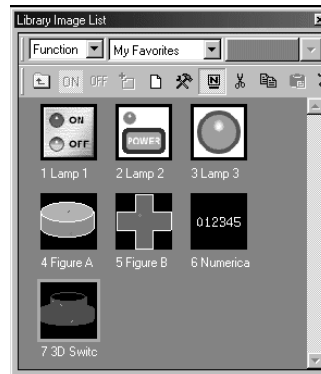
## 7.3.4 Editing registered objects and figures

Objects and figures registered to My Favorite or the user created library are edited.

- 1 Select the template for editing.




Library workspace

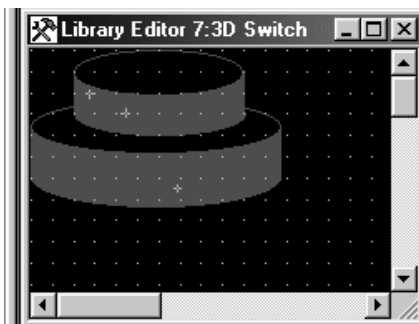



Library image list


- 2 Perform the operations below:

- (1) Editing in library workspace  
Right click the mouse to select the [Edit] menu.  
(The template can be edited by double clicking.)
- (2) Deleting in library image list  
Click the  (Library Edit) button.  
(The template can be edited by double clicking.)

- 3 The library editor screen appears. Edit the template.






- 4 After editing the template, close the screen. (Click the  button on the upper right of the screen.)  
If you want to cancel the edited result on the library editor screen, cancel the edition operation before closing the library editor screen.

 Section 8.2.4 Undo and redo



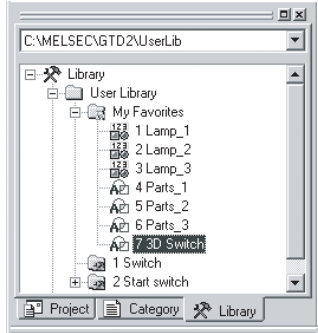
### Undoing and redoing the action

- Undo  
Reverses the last action just performed.
  - Click  (Undo).
  - Choose the [Edit] → [Undo] menu.
- Redo  
Re-executes the last action undone by clicking  (Undo).
  - Click  (Redo).
  - Choose the [Edit] → [Redo] menu.

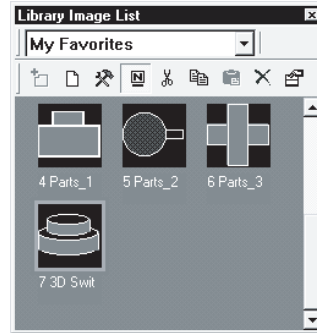
## 7.3.5 Changing library property

Number or name of user created library or registered template is changed.


- 1 Select the user created library/template for copying.



Library workspace

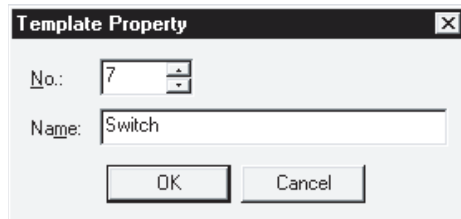


Library image list

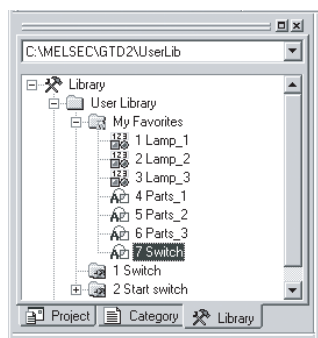
- 2 Perform the following operation:
  - (1) Editing in library workspace  
Right click the mouse to select [Property].
  - (2) Deleting in library image list  
Click the  (Property) button.

- 3 The template creation dialog box appears.

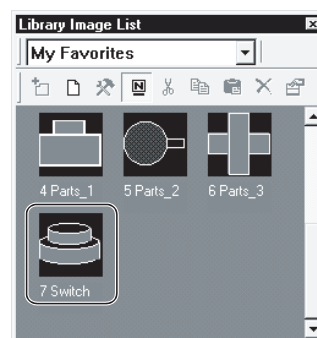
Change the library/template number and the library/template name. Click the **OK** button.



- 4 Property of the selected user created library/template is changed.



Library workspace



Library image list

## 7.3.6 Saving library

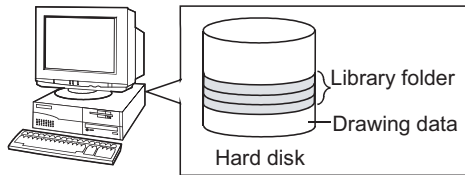
A user-created library (My Favorite, User Library) can be saved as a folder different from the currently displayed storage folder.

If create multiple library folders, you can choose a library from the multiple libraries at drawing. (☞ Section 7.3.7 Loading library from file)

In addition, by saving the folder in a floppy disc, the library can be shared with multiple PCs. For the operation method to open a library, refer to the following.

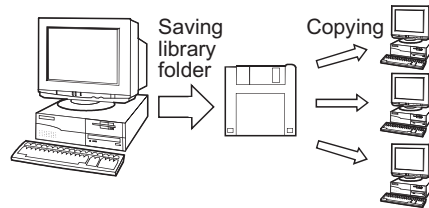
☞ Section 7.3.7 Loading library from file

(Ex.1)



Multiple library folder are saved in the PC hard disk.

(Ex.2)



A created library is shared with multiple PCs.



Creating GOT-A900 series screen and GOT-F900 series screen

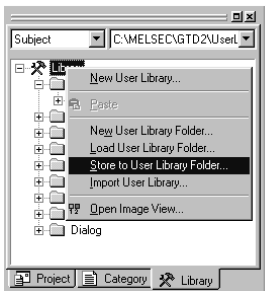
Make sure to create the library for GOT-A900 series screen and GOT-F900 series screen separately.

If the same library is used for both of them, the settings may be changed when the library is overwritten.

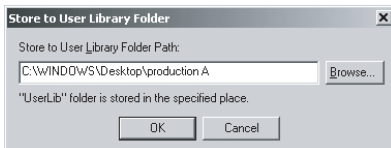
### 1 Saving created library

Save the created library according to the following procedure.

- 1 Select [Library] and right-click on it, and then click [Store to User Library Folder...].



- 2 As the Store to User Library Folder dialog box appears, specify a folder to store the library folder. The library file name is unchangeable. When saving multiple libraries, create a folder for each library file. After the specification, click the  button.



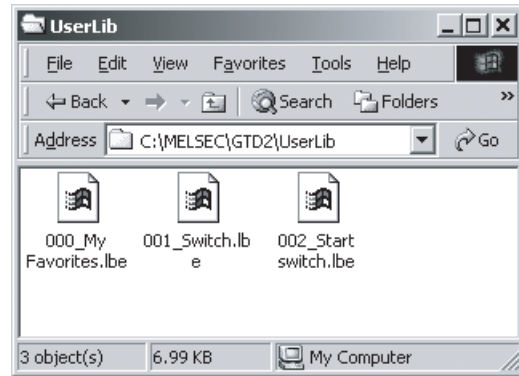
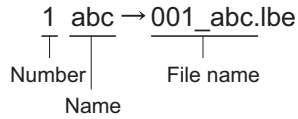
Saving multiple libraries

As library folder names are fixed, make sure to create a folder for each library folder when saving multiple libraries.



- 3 The library file is stored in the User Lib folder which is automatically created in the specified folder. A library for [My Favorites] is stored with a name of "000\_My Favorites.lbe". A user library file created by a user is named by using the number and name of the library.

Example) User library "1 abc"



**Point**

Do not operate (adding, deleting or renaming or others) the [User Lib] folder or files in the folder on the Explorer.

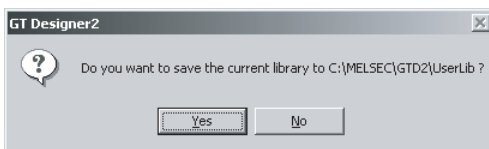
**2** Creating a new library irrespective of the one already created.

Create a new library folder separately from the one already created, according to the following procedure.

**1** Select [Library] and right-click on it and then click the [New User Library Folder...] menu.

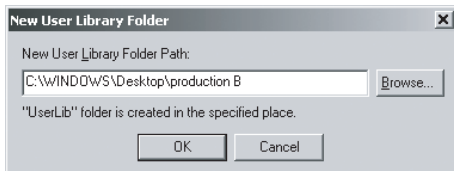


**2** The dialog box appears asking whether the currently edited library data is saved or not. When saving the library, click the **Yes** button.



**3** Specify the folder to store the library file.

The library file name is unchangeable. When saving multiple libraries, create a folder for each library file. After the specification, click the **OK** button.

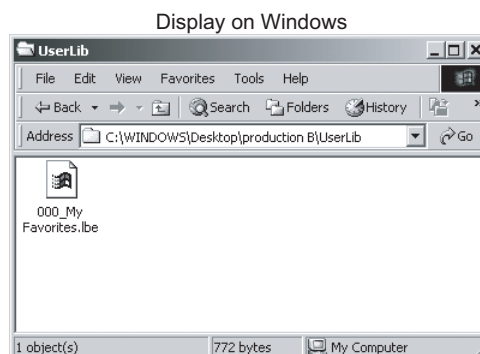
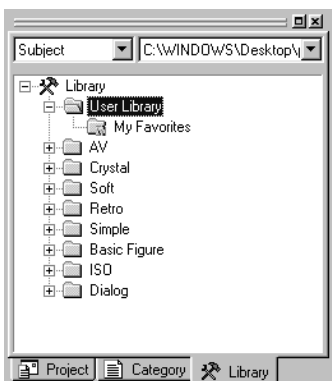


**Point**

**Saving multiple libraries**

To save multiple libraries, create a folder for each library folder as library file names are fixed.

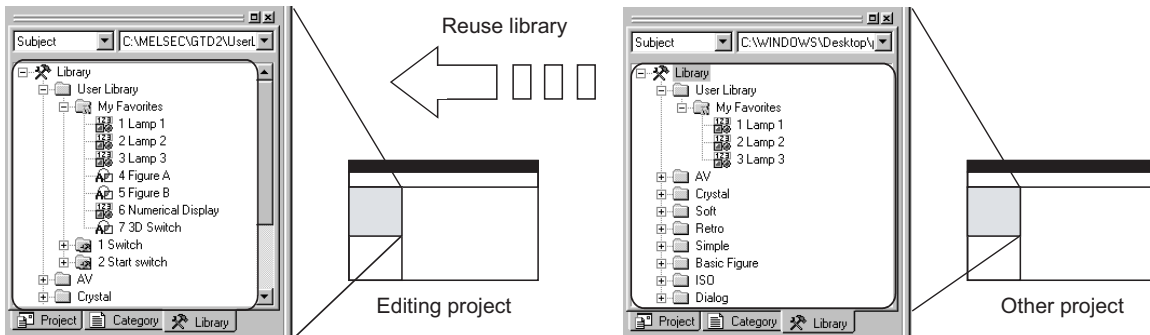
**4** The library file (\*.lbe) is stored (created) in the User Lib folder which is newly created in the specified folder automatically.



## 7.3.7 Loading library from file

The specified user library folder can be opened to change the contents of My Favorites or User Library. A user library folder created on another PC can be opened and used for the library of the project being edited.

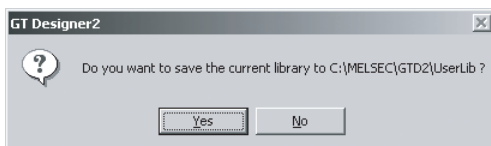
(Ex.) Library data of other project are loaded into the editing project.



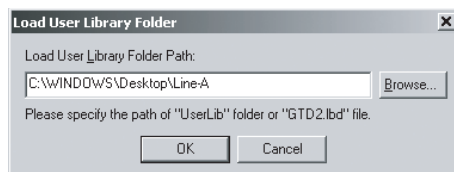
- 1 Right click the mouse at a blank space in the library workspace and click [Load User Library Folder].



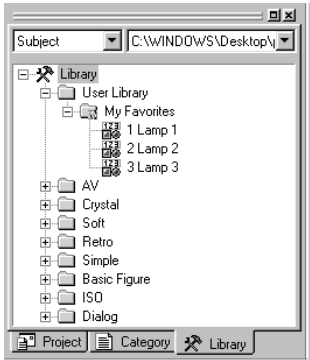
- 2 The dialog box to confirm if the currently editing library data are saved or not appears. Click the  Yes or  No button.



- 3 The Load User Library Folder dialog box appears. Specify the folder (one upper hierarchy) of the user library folder to be loaded and click the  OK button.

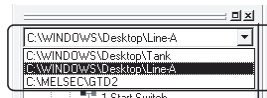


- 4 The display switches to the library contents (My Favorites, User-created libraries) of the library file in the specified folder.



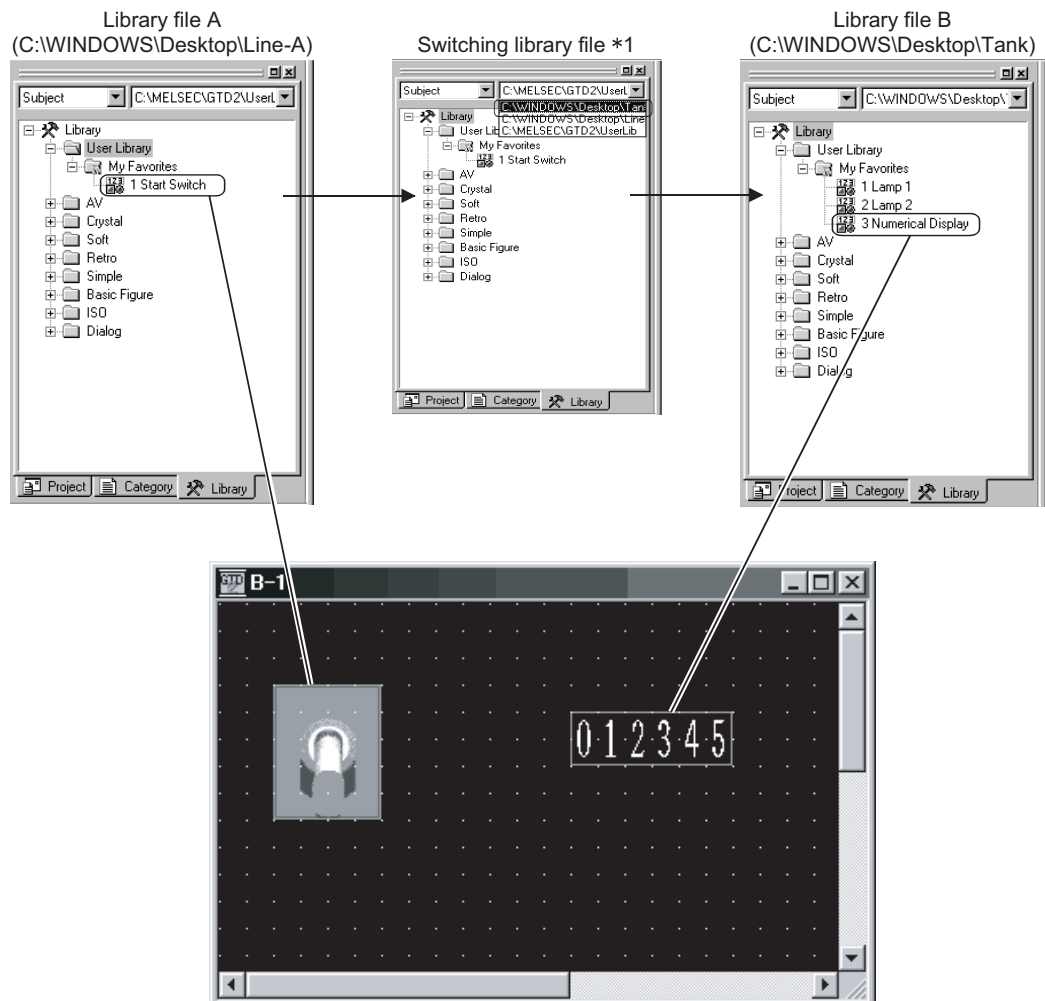
Loading multiple library files to create project

Alternate loading of multiple library folders facilitates use of multiple library folders for one project.



As the storage location of the loaded library file is displayed in the list box at the upper part of the library workspace, multiple library files can be easily loaded.

Ex.) After using the switch of library file A, use the numerical display of library file B.



## 7.3.8 Importing user library

Another library with the being-edited library can be imported from the context menu of the library workspace.

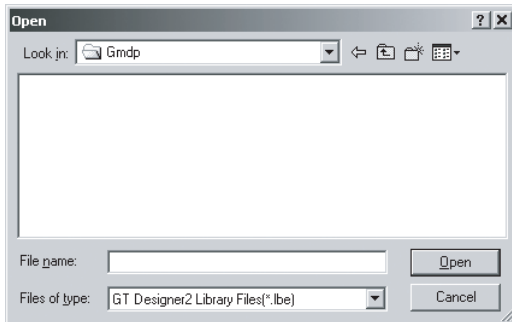
### 1 Importing a user library

The following describes how to import a user library.

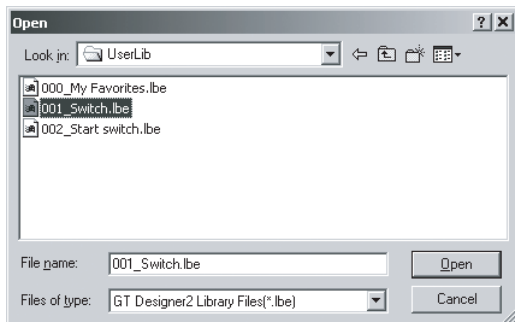
- 1 Select [Library] and right-click on it, and then click the [Import User Library] menu.



- 2 Select a file type (GTD2.lbd or \*.lbe) for the file to be imported.



- 3 Select a file to be imported and click **Open**.



- 4 The imported file is added to the user library.



\* When importing files of "\*\*\*\*.lbe"

- Multiple files can be selected.
- The selected "\*\*\*\*.lbe" files are allocated to unused library numbers automatically, and added to the User Library.
- The [000\_My Favorites.lbe] is imported by a template unit.

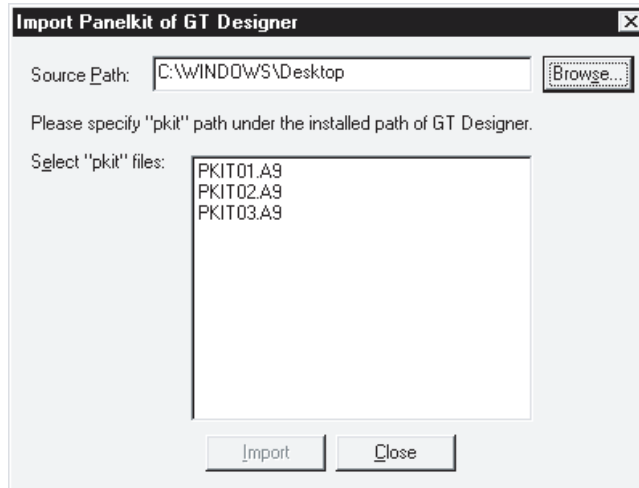
\* When importing files of "GTD2.lbd"

- The selected "GTD2.lbd" files are allocated to unused library numbers automatically, and added to the User Library.
- The [My Favorites] is imported by a template unit.

# 7.4 Utilizing Panelkit of GT Designer

The panelkit created by GT Designer can be used on GT Designer2 by importing to the user library. The panelkit of GT Designer is equivalent to the user library of GT Designer2.

- 1 Select the [Project] → [Import Panelkit of GT Designer] menu.
- 2 The Import Panelkit of GT Designer dialog box appears. Refer to the following descriptions for setting:



Item	Description	A	F
Source Path	Storage location of the panelkit of the GT Designer is specified.	<input type="radio"/>	x
Select "pkit" files	Panelkit files in the [Source path] are displayed. The selected panelkit file is imported to the GT Designer2.	<input type="radio"/>	x

- 3 Click the  button to import the panelkit.

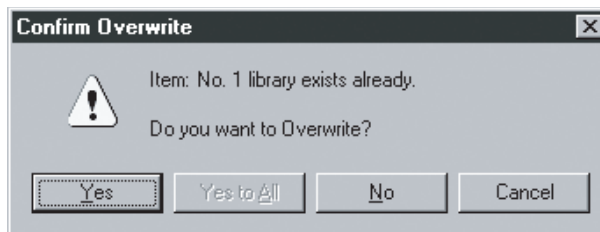


**Panelkit No. and user library No.**

As the panelkit and user library are assigned to the same No., the following message is displayed if the user library of the same No. has already been created.

To allow the user library to be overwritten, click the  button.

To prevent the user library from being overwritten, click the  or  button. The user library No. can be changed on the user library property.























# 8. DRAW AND EDIT

## 8.1 Drawing Figures

### 8.1.1 Drawing figures

1 Draw each type of figure as follows:

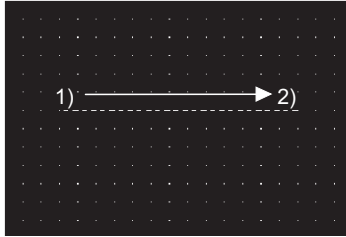
Figure	Drawing example	Operation	A	F
Line		<ul style="list-style-type: none"> <li> (Line)</li> <li>[Figure] → [Line] menu</li> </ul>	<input type="radio"/>	<input type="radio"/>
Line FreeForm		<ul style="list-style-type: none"> <li> (Line FreeForm)</li> <li>[Figure] → [Line FreeForm] menu</li> </ul>	<input type="radio"/>	<input type="checkbox"/>
Rectangle	 	<ul style="list-style-type: none"> <li> (Rectangle)</li> <li>[Figure] → [Rectangle] menu</li> <li> (Rectangle (Filled))</li> <li>[Figure] → [Rectangle] (Filled) menu</li> </ul>	<input type="radio"/>	<input type="radio"/>
Polygon		<ul style="list-style-type: none"> <li> (Polygon)</li> <li>[Figure] → [Polygon] menu</li> </ul>	<input type="radio"/>	<input type="checkbox"/>
Circle (including ellipses (GOT-A900 Series only))	 	<ul style="list-style-type: none"> <li> (Circle)</li> <li>[Figure] → [Circle] menu</li> <li> (Circle (Filled))</li> <li>[Figure] → [Circle (Filled)] menu</li> </ul>	<input type="radio"/>	<input type="radio"/>
Arc (including elliptic arc)		<ul style="list-style-type: none"> <li> (Arc)</li> <li>[Figure] → [Arc] menu</li> </ul>	<input type="radio"/>	<input type="checkbox"/>
Sector		<ul style="list-style-type: none"> <li> (Sector)</li> <li>[Figure] → [Sector] form</li> </ul>	<input type="radio"/>	<input type="checkbox"/>
Scale		<ul style="list-style-type: none"> <li> (Scale)</li> <li>[Figure] → [Scale] menu</li> </ul>	<input type="radio"/>	<input type="checkbox"/>



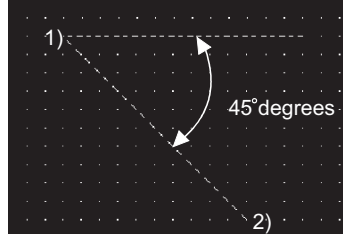
## 2 Drawing figures

### (1) Line

Drag from start point 1) to end point 2), and release the left button of the mouse.

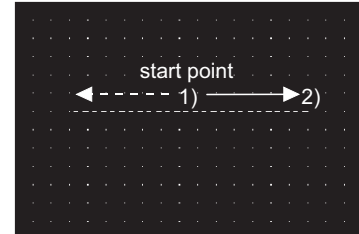


Draw while pressing the **Shift** key.



Lines can be drawn at the angle of 45 degrees.

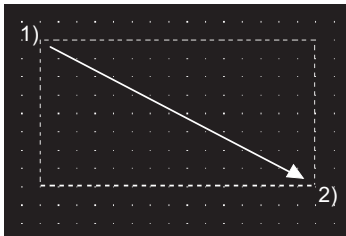
Draw while pressing the **Ctrl** key.



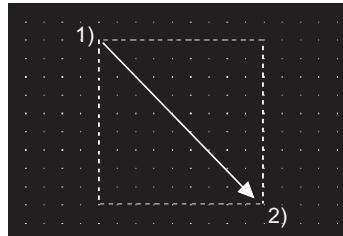
A line can be drawn from the start point as a center.

### (2) Rectangle

Drag from start point 1) to end point 2), and release the left button of the mouse.

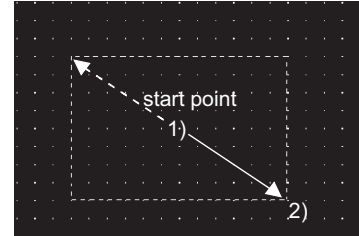


Draw while pressing the **Shift** key.



A square can be drawn.

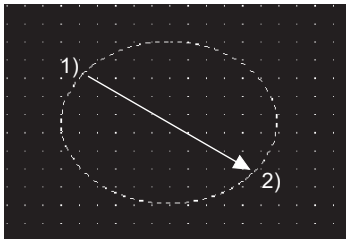
Draw while pressing the **Ctrl** key.



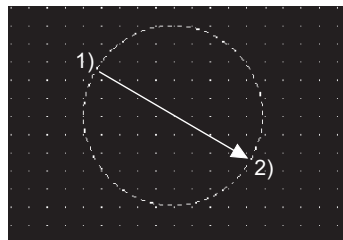
A rectangle can be drawn from the start point as a center.

### (3) Circle

Drag from start point 1) to end point 2), and release the left button of the mouse.

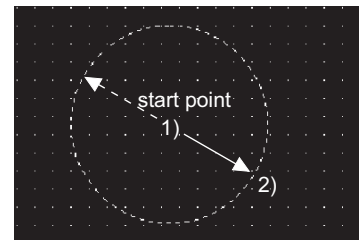


Draw while pressing the **Shift** key.



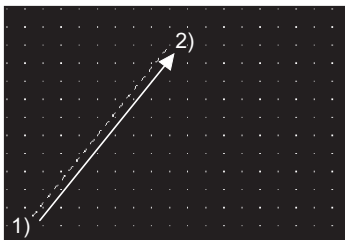
A complete round circle can be drawn.

Draw while pressing the **Ctrl** key.

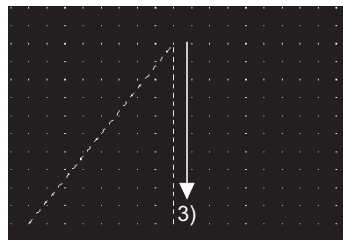


A circle can be drawn from the start point as a center.

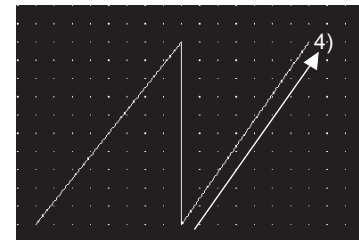
### (4) Line free form



Drag from start point 1) to end point 2) of the first line, and release the left button of the mouse.

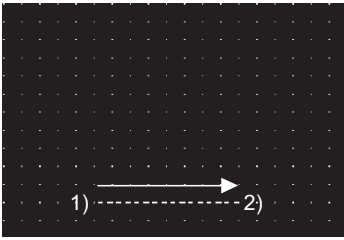


Click at the end point of next line 3).

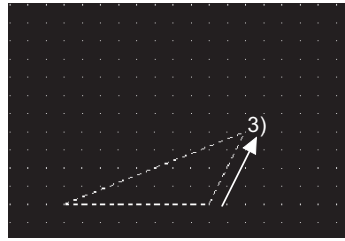


Repeat the operation in 3) until a figure is drawn. Double click end point 4) to complete drawing.

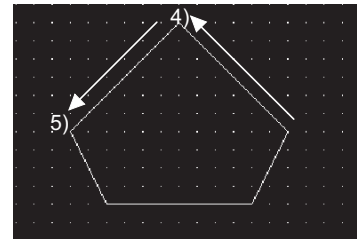
### (5) Polygon



Drag from start point 1) to end point 2) of the first side, and release the left button of the mouse.

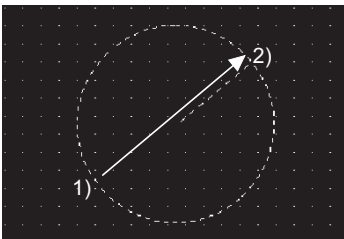


A dashed line is displayed. Click at the end point of next side 3).

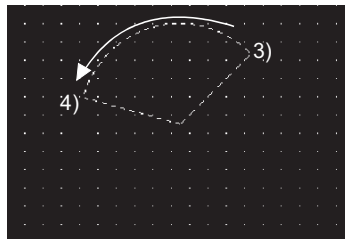


Repeat the operation in 3) until the desired figure is drawn. Double click 4) to complete drawing.

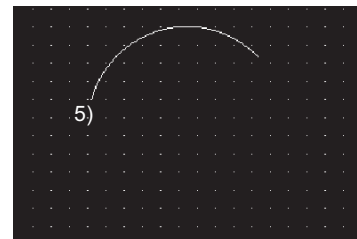
### (6) Arc



Drag from start point 1) to end point 2) to determine the radius of arc. A dashed line is displayed inside the circle.

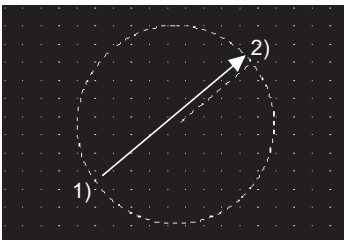


Click the left mouse button at the start point of arc 3), and move the cursor to end point 4).

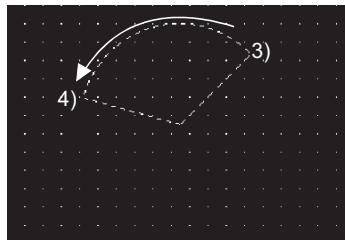


Click end point 4) to complete drawing.

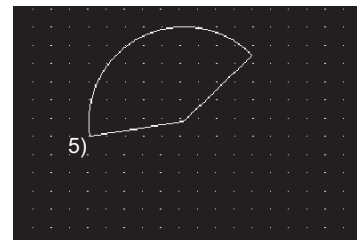
### (7) Sector



Drag from start point 1) to end point 2) to determine the radius of sector. A dashed line is displayed inside the circle.



Click the left mouse button at the start point of sector 3), and move the cursor to the end point 4).

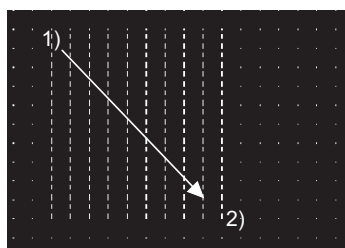
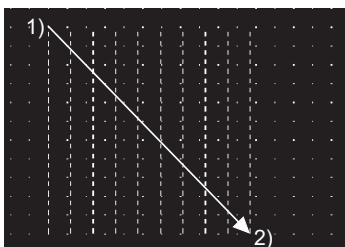


Click end point 4) to complete drawing.

### (8) Scale

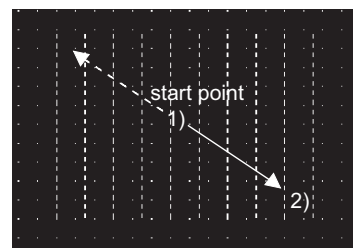
Drag from start point 1) to end point 2), and release the left button of the mouse.

Draw while pressing the **Shift** key.



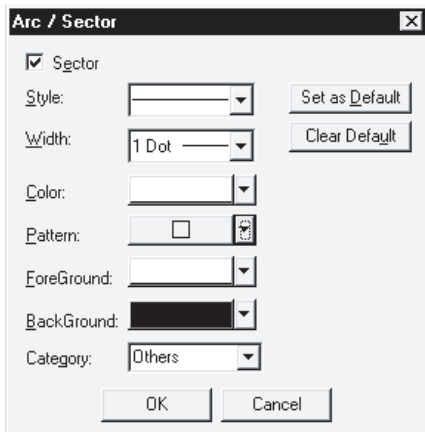
A scale with the same vertical and horizontal sizes can be drawn.

Draw while pressing the **Ctrl** key.

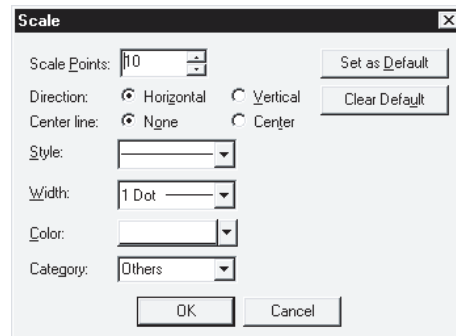


A scale can be drawn from the start point as a center.



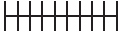




- 3 Double click a figure to determine the attribute.



(Ex.: Setting of arc/sector)



(Ex.: Setting of scale)

Item	Description	A	F
Sector *1	This is checked to create a sector. Checked  Not checked 	<input type="radio"/>	<input checked="" type="radio"/>
Scale Points *2	Number of lines (2 to 255) on the scale is set.	<input type="radio"/>	<input checked="" type="radio"/>
Direction *2	Direction of the scale is selected. Horizontal:  Vertical: 	<input type="radio"/>	<input checked="" type="radio"/>
Center line *2	Position of the center line that makes a right angle to the scale is selected. Center:  None: 	<input type="radio"/>	<input checked="" type="radio"/>
Style	Line style of the figure is selected.	<input type="radio"/>	<input type="radio"/>
Width	Line width of the figure is selected.	<input type="radio"/>	<input checked="" type="radio"/>
Color	Line color of the figure is selected.	<input type="radio"/>	<input type="radio"/>
Pattern *4	Filling pattern is selected.	<input type="radio"/>	<input type="radio"/>
ForeGround *4	Display color of filling pattern is selected.	<input type="radio"/>	<input type="radio"/>
BackGround *4	Background color of filling pattern is selected.	<input type="radio"/>	<input type="radio"/>
Category	If a category is assigned to the figure, the category is selected.  Section 9.1.2 Batch setting and managing objects/figures for each purpose (Category workspace)	<input type="radio"/>	<input type="radio"/>
Set as Default *3	Click this to use the current attribute as the default user setting. In the next attribute setting, the default user setting is displayed.	<input type="radio"/>	<input type="radio"/>
Clear Default	Click this to return the attribute as the default value to the initial status.	<input type="radio"/>	<input type="radio"/>

Refer to the next page for details of \*1 to \*4.

**\*1 Sector**

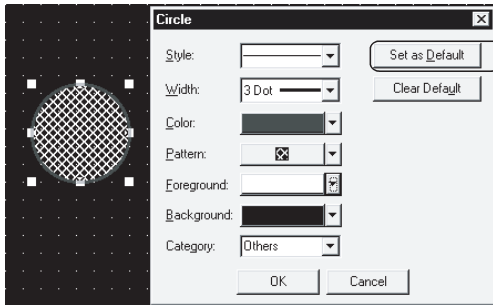
This is the setting item only for arc and sector.

**\*2 Scale points, direction and center line**

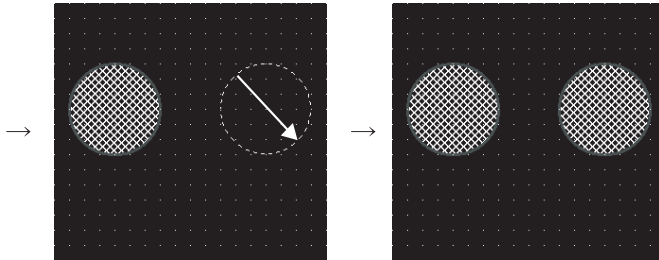
These are the setting items only for scale.

**\*3 Set as Default**

Set the user attribute as the default value. Figures with the same attribute can be drawn continuously.



Click the "Set As Default" button.



When the same figure is drawn next time, it can be drawn with the values set as default.

**\*4 Pattern, Foreground, Background**

These are the setting items only for rectangle, circle (ellipse), polygon, arc (elliptical arc) and sector.

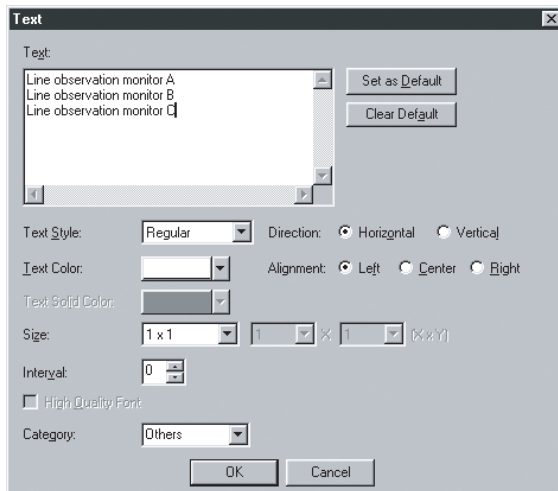
## 8.1.2 Entering text

1 Perform either of the following operations:

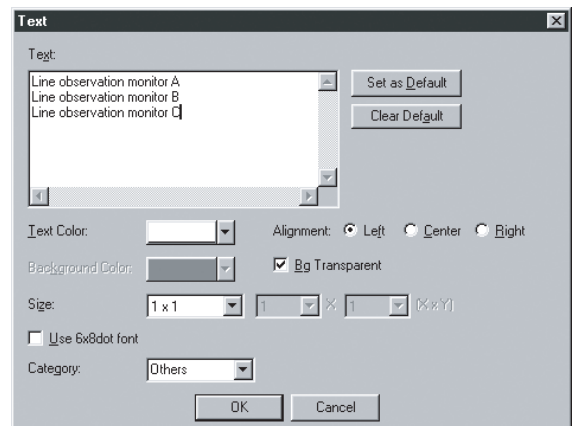
- Click **A** (Text).
- Select the [Figure] → [Text] menu.

2 Click on the screen. The text figure dialog box appears.

Enter the text, set the attribute of the text, and click the **OK** button. The entered text is displayed.

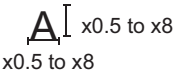
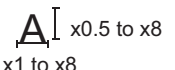
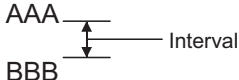



GOT-A900 Series



GOT-F900 Series

Item	Description	A	F
Text	<p>Text you want to display is entered.</p> <ul style="list-style-type: none"> <li>• Maximum 512 characters can be entered. (A line feed is counted as one character.)</li> <li>• Text can be entered in multiple lines.</li> </ul> <p>Press the <b>Enter</b> key at the end of the line to feed a line.</p> <p>&lt;Input Ex.&gt;                      &lt;Display Ex.&gt;</p> <div style="display: flex; justify-content: space-around;"> <div style="border: 1px solid black; padding: 5px;"> <p><b>Text</b></p> <p>Text:</p> <p>Line observation monitor A</p> <p>Line observation monitor B</p> <p>Line observation monitor C</p> </div> <div style="border: 1px solid black; padding: 5px; background-color: black; color: white;"> <p>Line observation monitor A</p> <p>Line observation monitor B</p> <p>Line observation monitor C</p> </div> </div>	○	○
	<p>Input an external character to be displayed (which should be created in advance using the external character creation function).</p> <p>When the external character No. is sandwiched with " " (half-width vertical bar)", a corresponding external character is displayed as one character.</p> <p>When " 1  2 " is input, two characters whose external character Nos. are 1 and 2 are displayed.</p>	×	○
Style	<p>The display format of the text is selected.</p> <div style="display: flex; justify-content: center; gap: 10px;"> </div> <p>Standard   Bold   Solid color   Sculpture</p>	○	×
Text	Color of the text is selected.	○	○
Direction	<p>Direction of the text (horizontal/vertical) is selected.</p> <p>[Horizontal] AAA   [Vertical] A</p> <p style="margin-left: 100px;">A</p> <p style="margin-left: 100px;">A</p>	○	×

Item	Description	A	F									
Alignment	Reference position to align multiple text lines is selected. (It is available only when the [Direction] is set to "Horizontal.") Left: <table border="1" style="display: inline-table; vertical-align: middle;"><tr><td>AAAA</td></tr><tr><td>BB</td></tr><tr><td>CCCC</td></tr></table> Right: <table border="1" style="display: inline-table; vertical-align: middle;"><tr><td>AAAA</td></tr><tr><td>BB</td></tr><tr><td>CCCC</td></tr></table> Center: <table border="1" style="display: inline-table; vertical-align: middle;"><tr><td>AAAA</td></tr><tr><td>BB</td></tr><tr><td>CCCC</td></tr></table>	AAAA	BB	CCCC	AAAA	BB	CCCC	AAAA	BB	CCCC	<input type="radio"/>	<input type="radio"/>
AAAA												
BB												
CCCC												
AAAA												
BB												
CCCC												
AAAA												
BB												
CCCC												
Solid	Solid color is selected when the [Style] is set to [Solid] or [Sculpture].	<input type="radio"/>	<input checked="" type="radio"/>									
Bg transparent	Check this to make the background of the text transparent.	<input checked="" type="radio"/>	<input type="radio"/>									
Size	Text size (magnifying factor of vertical × horizontal sizes) is selected. When the magnifying factor is x1 horizontal and x1 vertical, the text size is 8 × 16 dots (horizontal × vertical). GOT-A900 Series                      GOT-F900 Series  x0.5 to x8  x0.5 to x8	<input type="radio"/>	<input type="radio"/>									
Interval	Interval between lines is set. 	<input type="radio"/>	<input checked="" type="radio"/>									
High Quality Font	Check this to use the high quality font. (It is available only when the horizontal and vertical "sizes" are set to 2, 4, 6 or 8 times.)	<input type="radio"/>	<input checked="" type="radio"/>									
Category	When a category is assigned to the figure, the category is selected. (  Section 9.1.2 Batch setting and managing objects/figures for each purpose (Category workspace))	<input type="radio"/>	<input type="radio"/>									
Use 6 × 8 dot font	Text with the font size of 6 × 8 dots is displayed.	<input checked="" type="radio"/>	<input type="radio"/>									
Set as Default	Click this to use the current attribute as the default user setting. In the next attribute setting, the default user setting is displayed.	<input type="radio"/>	<input type="radio"/>									
Clear Default	Click this to return the attribute as the default value to the initial status.	<input type="radio"/>	<input type="radio"/>									

**Remark**

(1) Precautions for vertical text

If the text is displayed in the vertical direction, the text is displayed as follows:

(Ex. 1) "-"

Horizontal : 10 - 20  
Vertical : 1  
                  0  
                  -  
                  2  
                  0

(Ex. 2) "Caution"

Horizontal : Caution  
Vertical : (   
                  C  
                  a  
                  u  
                  t  
                  i  
                  o  
                  n  
                  )

(2) Font types that can be displayed on GOT

(a) Font types displayed on the GT Designer2 can be displayed on the GOT.

However, fonts that are displayed as "?" or in different sizes after arrangement on the drawing screen cannot be displayed on the GOT even if these fonts are correctly defined and displayed only on the screen.

(b) The GOT can display the following languages: Japanese, Korean, Chinese (Simplified Chinese and Traditional Chinese), English, German, French, Portuguese and Spanish.

Japanese, Korean and Chinese include the same Chinese characters. When displaying these characters, the Japanese ones will be prioritized.

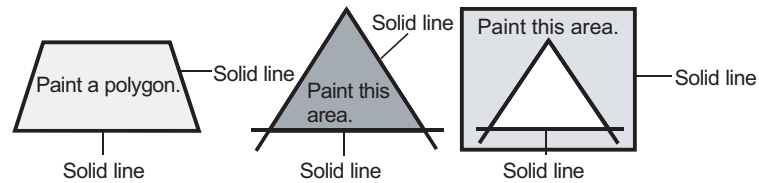
### 8.1.3 Painting figures

Closed area and polygon are painted.

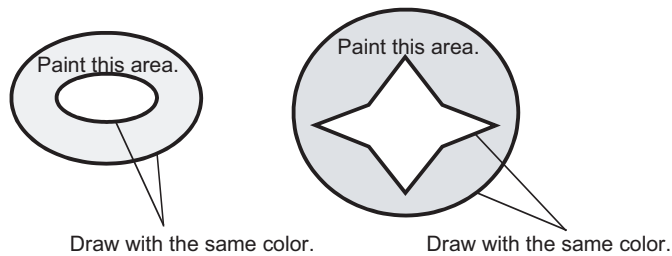
#### 1 Before painting (filling)

Draw areas for painting as follows:

- (1) Close the area to paint with solid lines.



- (2) Use the same color for outlines of the area to be painted.



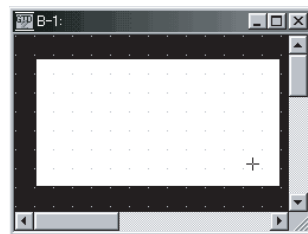
#### Remark

- (1) Precautions for figure to be painted
- (a) Note that any opening of the outline leads to protrusion of paint from the edge of the figure.
  - (b) Inside of the figure drawn with the same boundary color as the background color cannot be painted. Select a boundary color different from the background color.

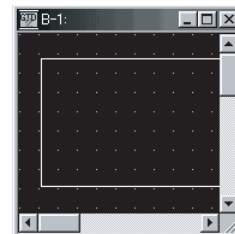
- (2) Display of paint mark

Figures are not painted unless the paint mark is displayed on the screen.

The paint mark is displayed on the screen.



The paint mark is not displayed on the screen.



- (3) Redisplay

If paint is used, unpainted areas may occur.


Redisplay provides correct display.

Refer to the following for redisplay.

 Section 3.4.5 Redisplaying drawing screen

## 2 Painting

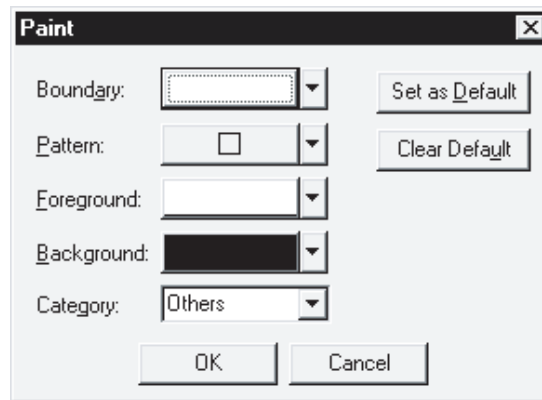
1 Perform either of the following operations:

- Click  (Paint).
- Select the [Figure] → [Paint] from the menu.

2 Move the cursor to the area for painting and click within the paint area.

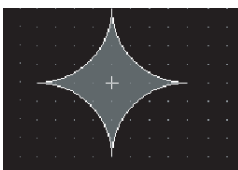


3 The paint setting dialog box appears. Set the attribute, and click the **OK** button.



Item	Description	A	F
Boundary color	The boundary color of the area is selected. The line set here is the boundary line of the painted area.	○	×
Pattern	Filling pattern is selected.	○	×
Foreground	The color of filling pattern is selected.	○	×
Background	Background color of filling pattern is selected.	○	×
Category	When a category is assigned to the figure, the category is selected. (☞ Section 9.1.2 Batch setting and managing objects/figures for each purpose (Category workspace))	○	×
Set As Default	Click this to use the current attribute as the default user setting. In the next attribute setting, the default user setting is displayed.	○	×
Clear Default	Click this to return the attribute as the default value to the initial status.	○	×

4 The paint mark is displayed at the click position and the figure is painted.



The paint mark is displayed on the GT Desinger2 only and not on the GOT.  
To edit the attribute of painting, double click the paint mark.

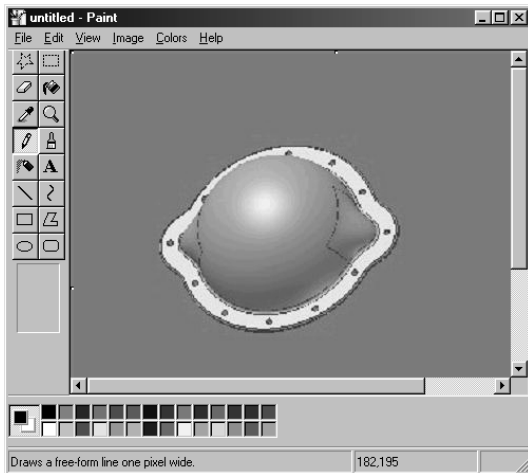


## 8.1.4 Capture function

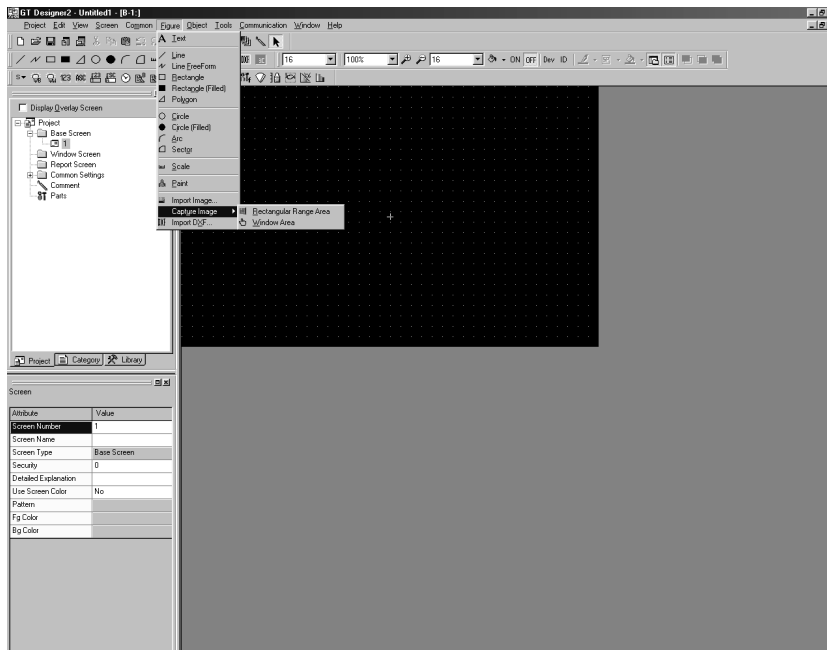
A specified area of the figure can be captured and imported to the GT Designer2 as BMP data.

### 1 Operation method

- 1 Click the window that has the figure to import to make it active.



- 2 Define capture area from [Capture Image] in the menu [Figure] on GT Designer2. Once capture area is defined, GT Designer2 window becomes minimized. Only the function to specify capture area can be operated. To cancel this function, press the **[ESC]** key.

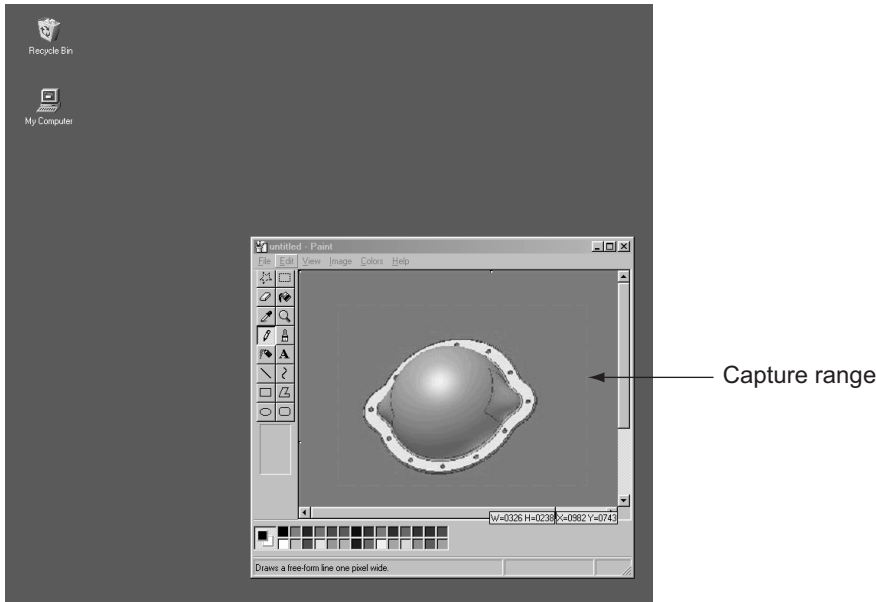


- 3 There are two ways to specify a capture area.



[Rectangular Range Area]

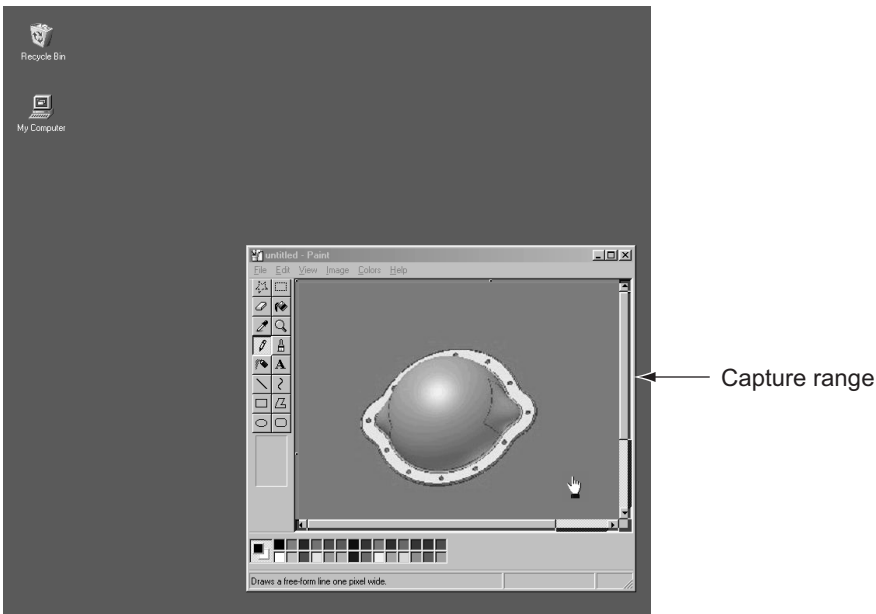
Selecting [Rectangular Range Area] minimizes the GT Designer2 window, and the cursor shape changes to for [Rectangular Range Area].

Drag the cursor from the starting point to the ending point to determine the range to be captured.

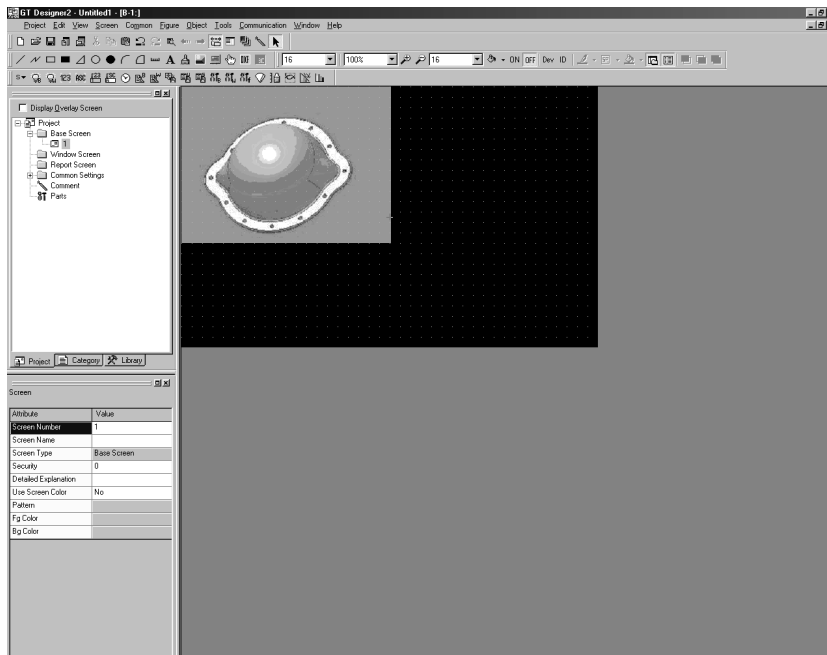


[Window Area]

Selecting [Window Area] minimizes the GT Designer2 window and the cursor changes to  for [Window Area]. The area to be captured is framed with black line by moving  into the client area. Click the area to select it.



- 4 After clicking the screen of the GT Designer2, the captured figure can be imported to GT Designer2 as BMP data.



## 2 How to edit

Refer to Section 8.1.5 Pasting figure data of BMP/DXF file for how to edit the imported BMP data.



Note the following points for capturing data.



- It may take some time for the screen to appear when a large captured figure is imported or when the screen on which many figures are pasted is opened.
- When the size of the captured data is bigger than that of temporary area, it is automatically adjusted to fit the temporary area.
- Some files that are created with DirectX or animation application cannot be captured.

## 8.1.5 Pasting figure data of BMP file

This function imports figure data (BMP/DXF (AutoCAD drawing file) format) to GT Designer2 and pastes the figure on the screen.

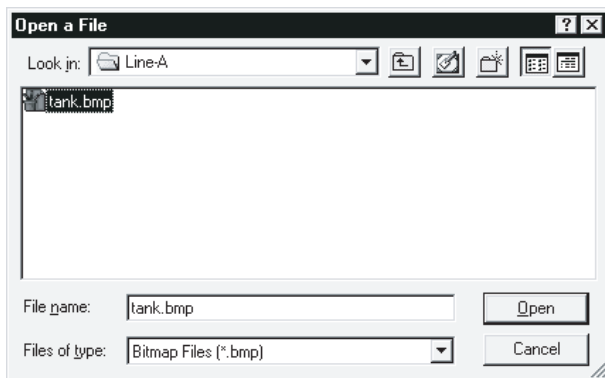
### 1 Operation method

1 Perform either of the following operations:

File format	Description	Operation	A	F
BMP	BMP format file is imported as an image.	<ul style="list-style-type: none"> <li> (Image data)</li> <li>[Figure] → [Import Image] menu</li> </ul>	<input type="radio"/>	×
DXF	DXF format file is imported as an image.	<ul style="list-style-type: none"> <li> (Import DXF)</li> <li>[Figure] → [Import DXF] menu</li> </ul>	<input type="radio"/>	<input type="radio"/>

2 The Open a File dialog box appears.

Select the file of the figure data to be imported and click the **Open** button.



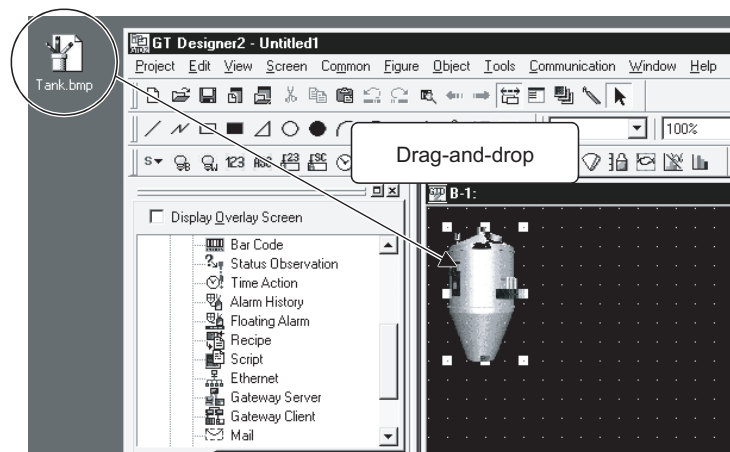
3 Pasting a file by drag-and-drop

The BMP/DXF format file can be pasted onto the GT Designer2 screen by drag-and-drop operation.



Pasting a file by drag-and-drop

The BMP/DXF format file can be pasted onto the GT Designer2 screen by drag-and-drop operation.



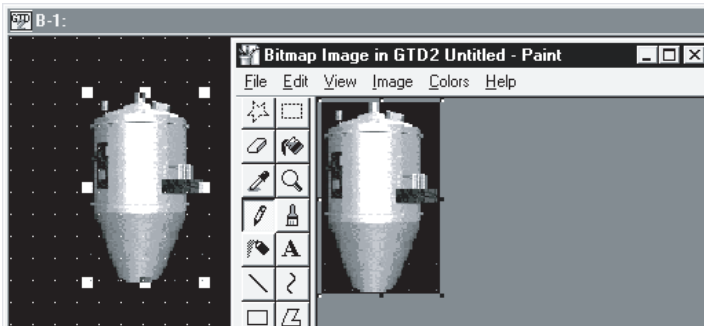
## 2 BMP format file

- (1) Compatible BMP format file  
2-color/16-color/256-color BMP format data can be imported.

### **Point**

Note the following points when importing data to GT Designer2.

- When the BMP format data that includes more colors than the color setting is imported to GT Designer2, the imported data will be displayed (Subtractive process will be automatically performed).
  - The BMP format data of which colors are reduced once on GT Designer2 cannot be returned to the previous color setting. Import the BMP file again.
  - The color arrangement of the image data imported to GT Designer2 may slightly differ from that of the image data displayed on the GOT.
- (2) The size of the figure to be imported  
When the size of the figure to be imported is bigger than that of temporary area, it is automatically adjusted to fit the temporary area.
  - (3) Editing BMP format figure data  
Click the BMP format figure data to start the painting software. Then, modify the figure.  
Closing the software ensures the modification on the figure data.



- (4) Category  
After being imported, the BMP format data will be registered and stored in "Others".

## 3 DXF format file

- (1) Compatible DXF format data
  - (a) Compatible DXF format data  
The DXF format data created using the following Auto CAD (version) can be imported.
    - Release 12
    - Release 13
    - Release 14
  - (b) Notes on importing data
    - The data with the layer off cannot be converted.
    - Only the Shift JIS code text is compatible.
    - The coordinate unit "1" is converted to 1 dot on GT Designer2.
    - 10 minutes or longer may be required in some cases.
    - The figure bigger than 2048 x 1536 dot cannot be imported.

(c) Details of DXF data import

The following DXF data can be imported to GT Designer2.

If some figures or attributes cannot be imported, draw them or make the relevant settings on GT Designer2.

Before import (DXF data)	After import (GTD2 data)	Remarks	A	F
ARC	Arc	-	○	×
ATTDEF	(Ignored)	-	○	○
ATTRIB	Text	<ul style="list-style-type: none"> <li>The text size is converted to the nearest one (0.5 to 8 times) of GT Designer2.</li> <li>The rotation setting is converted to the nearest one in 90-degree units. For GOT-F900 series, always converted to "0"degree, i.e., "No rotation".</li> <li>The text style including slant angle is not supported.</li> </ul>	○	○
CIRCLE	Circle	<ul style="list-style-type: none"> <li>For GOT-F900 series, converted to a line.</li> </ul>	○	○
DIMENSION	Group	<ul style="list-style-type: none"> <li>The color and line style are converted based on the DIMENSION block definition instead of the layer.</li> </ul>	○	○
ELLIPSE	Circle or Arc	<ul style="list-style-type: none"> <li>The slanted figure is converted so that its main axis will be rotated horizontally or vertically.</li> </ul>	○	×
INSERT	Group	<ul style="list-style-type: none"> <li>The color and line style are converted based on the DIMENSION block definition instead of the layer. The scale and rotation angle are not supported.</li> </ul>	○	○
LEADER	Line Free Form	<ul style="list-style-type: none"> <li>The figure is converted to be a line free form (the end points are connected in a straight line).</li> </ul>	○	×
LINE	Line	-	○	○
LWPOLYLINE	Line Free Form or Polygon	<ul style="list-style-type: none"> <li>The figure is converted to be a line free form or polygon (the end points are connected in a straight line).</li> <li>The curved lines between the points are ignored.</li> </ul>	○	×
MLINE	Line Free Form	<ul style="list-style-type: none"> <li>The MLINestyle is not supported. Each line free form color and the line style are converted based on the layer definition.</li> <li>Cap processing is not supported.</li> </ul>	○	×
MTEXT	Text	<ul style="list-style-type: none"> <li>The text size is converted to the nearest one (0.5 to 8 times) of GT Designer2.</li> <li>The rotation setting is converted to the nearest one in 90-degree units. For GOT-F900 series, always converted to "0"degree, i.e., "No rotation".</li> <li>The form code is deleted.</li> <li>The text style is not supported.</li> </ul>	○	○
POINT	Circle, Rectangle, Line	-	○	○
POLYLINE	Line Free Form or Polygon	<ul style="list-style-type: none"> <li>The figure is converted to a line free form or polygon (the end points are connected in a straight line).</li> <li>The curved lines between the points are ignored.</li> </ul>	○	×
SOLID	Polygon	-	○	×
SPLINE	Line Free Form or Polygon	<ul style="list-style-type: none"> <li>The figure is converted to be a line free form or polygon (the fit lines are connected in a straight line).</li> </ul>	○	×
TEXT	Text	<ul style="list-style-type: none"> <li>The text size is converted to the nearest one (0.5 to 8 times) of GT Designer2.</li> <li>The rotation setting is converted to the nearest one in 90-degree units. For GOT-F900 series, always converted to "0"degree, i.e., "No rotation".</li> <li>The text style including slant angle is not supported.</li> </ul>	○	○
TRACE	Polygon	-	○	×



## Notes on importing data

GT Designer2 converts only the compatible characters within a DXF data during data import.

Therefore, some characters may appear differently from the original data.

Make sure to modify the figure after data import.

Example 1) " $\phi$ " cannot be imported.

As the " $\phi$ " in DXF data is not the Shift JIS code, this character cannot be imported.

Example 2) The BLOCK created with rectilinear and circle figures on the AutoCAD screen appear larger than the original size.

As the scale is set in the INSERT, the BLOCK cannot be correctly imported.

(d) Line

Each line is converted as shown below (1-dot width).

Before import (DXF data)	After import (GTD2 data)	A	F
CONTINUOUS	————— Full line	<input type="radio"/>	<input type="radio"/>
DASHED	----- Dotted line	<input type="radio"/>	<input type="radio"/>
HIDDEN	----- Dotted line	<input type="radio"/>	<input type="radio"/>
CENTER	----- Dashed line	<input type="radio"/>	<input type="radio"/>
PHANTOM	----- Dashed line	<input type="radio"/>	<input type="radio"/>
User definition	————— Full line	<input type="radio"/>	<input type="radio"/>
Others	————— Full line	<input type="radio"/>	<input type="radio"/>

(e) Color

The color is converted as shown below.

Before import (DXF data)	After import (GTD2 data)	A	F
Red (0x09)	Red (224)	<input type="radio"/>	<input type="radio"/>
Yellow (0x02)	Yellow (252)	<input type="radio"/>	<input type="radio"/>
Green (0x03)	Green (28)	<input type="radio"/>	<input type="radio"/>
Light blue (0x04)	Light blue (31)	<input type="radio"/>	<input type="radio"/>
Blue (0x05)	Blue (3)	<input type="radio"/>	<input type="radio"/>
Purple (0x06)	Purple (227)	<input type="radio"/>	<input type="radio"/>
White (0x07)	White (255)	<input type="radio"/>	<input type="radio"/>
Black (0x08)	Black (0)	<input type="radio"/>	<input type="radio"/>
Dark red (0x09)	Dark red (160)	<input type="radio"/>	<input type="radio"/>
Dark yellow (0x0A)	Dark yellow (180)	<input type="radio"/>	<input type="radio"/>
Dark green (0x0B)	Dark green (20)	<input type="radio"/>	<input type="radio"/>
Dark-light blue (0x0C)	Dark-light blue (22)	<input type="radio"/>	<input type="radio"/>
Dark blue (0x0D)	Dark blue (2)	<input type="radio"/>	<input type="radio"/>
Dark purple (0x0E)	Dark purple (162)	<input type="radio"/>	<input type="radio"/>
Dark white (0x0F)	Dark white (109)	<input type="radio"/>	<input type="radio"/>
Others	Others (255)	<input type="radio"/>	<input type="radio"/>

(2) Editing DXF format figure data

To edit the grouped figure data on GT Desinger2, ungroup it once.

After the edition, group them again.

(3) Category

After being imported, the DXF format data will be registered and stored in "None".

(The ungrouped data will be also stored in "None".)



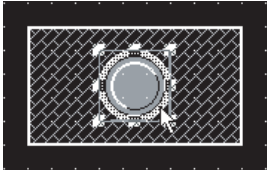


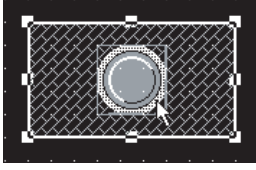


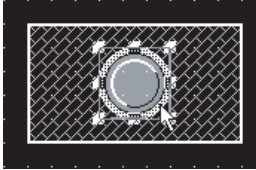
If necessary, register it again.



# 8.2 Editing Figure and Object

## 8.2.1 Selecting figure and object

Selection items with the cursor (figures and objects) can be changed by clicking. It is convenient to select the cursor type suitable for the editing item.

Cursor type	Description	Selecting operation	A	F
"Figure and Object" edit cursor	Selection and editing can be performed without distinguishing between figures and objects. (Cursor set as initial setting)			
	 <p>Both figure and object are selected.</p>	<ul style="list-style-type: none"> <li> (Select: Figure and Object)</li> <li>[Edit] → [Object of Selection] → [Figure and Object] from the menu</li> </ul>	○	○
 <p>If the figure and the object are overlapped, the object is selected.</p>				
"Figure" edit cursor	Figures can be edited.			
	 <p>Only the figure is selected.</p>	<ul style="list-style-type: none"> <li> (Select: Figure)</li> <li>[Edit] → [Object of Selection] → [Figure] from the menu</li> </ul>	○	○
 <p>If the figure and the object are overlapped, only the figure is selected.</p>				
"Object" edit cursor	Objects can be edited.			
	 <p>Only the object is selected.</p>	<ul style="list-style-type: none"> <li> (Select: Object)</li> <li>[Edit] → [Object of Selection] → [Object] from the menu</li> </ul>	○	○
 <p>If the figure and the object are overlapped, only the object is selected.</p>				



### Selection/de-selection of multiple figures or objects

(1) Selecting one from overlapped figures or objects

Move the cursor to the overlapped figures or objects and click while pressing the **Ctrl** key.


(2) De-selecting one from multiple figures or objects

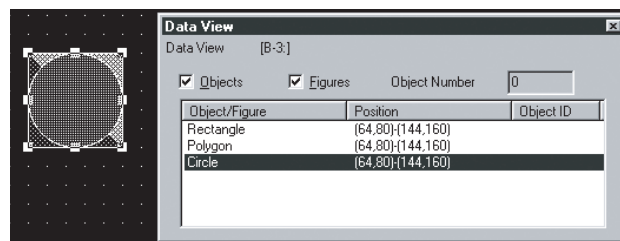
Move the cursor to the boundary line of a desired figure/object. Click while pressing the **Shift** key.

(3) Selecting figures or objects from the data view

The data view displays figures and objects on the screen in a list.

If figures or objects are overlapped, a desired figure/object can be simply selected from the data view.










 Section 9.1.4 Simple selection of overlapped figure (Data view)



## 8.2.2 Editing figures and objects

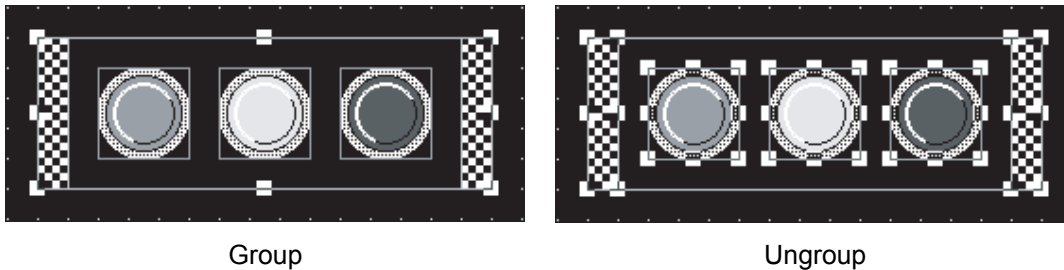
Different types of editing can be made for the figures and objects arranged on the screen.

- 1 Select the desired figure/object for editing.
- 2 Perform the following operations according to the editing details.



Function	Description	Operation	A	F
Delete	Figures and objects are deleted.	[Edit] → [Delete]	<input type="radio"/>	<input type="radio"/>
Cut	Figures and objects are cut.	<ul style="list-style-type: none"> <li>•  (Cut)</li> <li>• [Edit] → [Cut]</li> </ul>	<input type="radio"/>	<input type="radio"/>
Copy	Figures and objects are copied.	<ul style="list-style-type: none"> <li>•  (Copy)</li> <li>• [Edit] → [Copy]</li> </ul>	<input type="radio"/>	<input type="radio"/>
Paste	The cut/copied figures and objects are pasted.	<ul style="list-style-type: none"> <li>•  (Paste)</li> <li>• [Edit] → [Paste]</li> </ul>	<input type="radio"/>	<input type="radio"/>
Front/Back	The front/back position of the figure/object is replaced.  (Ex.) Bringing selected figure to the front	<ul style="list-style-type: none"> <li>•  (Bring to Front)</li> <li>• [Edit] → [Bring to Front]</li> </ul>	<input type="radio"/>	<input type="radio"/>
		<ul style="list-style-type: none"> <li>•  (Send to Back)</li> <li>• [Edit] → [Send to Back]</li> </ul>	<input type="radio"/>	<input type="radio"/>
Flip Vertical/Flip Horizontal	The selected figure is flipped. (Not available for objects)  (Ex.) Flipping selected figure vertically	<ul style="list-style-type: none"> <li>•  (Flip Vertical)</li> <li>• [Edit] → [Rotate/Flip] → [Flip Vertical]</li> </ul>	<input type="radio"/>	<input type="radio"/>
		<ul style="list-style-type: none"> <li>•  (Flip Horizontal)</li> <li>• [Edit] → [Rotate/Flip] → [Flip Horizontal]</li> </ul>	<input type="radio"/>	<input type="radio"/>
Rotate Left/Rotate Right	Figure is rotated 90 degrees to right/left. (Not available for objects)  (Ex.) Rotating selected figure 90 degrees to left	<ul style="list-style-type: none"> <li>•  (Rotate Left)</li> <li>• [Edit] → [Rotate/Flip] → [Rotate Left]</li> <li>•  (Rotate Right)</li> <li>• [Edit] → [Rotate/Flip] → [Rotate Right]</li> </ul>	<input type="radio"/>	<input type="radio"/>

## 8.2.3 Grouping/Ungrouping multiple figures and objects

Grouping of multiple figures and objects enables users to handle them as a single figure.



- 1 Select the desired figures and objects for grouping (ungrouping).
- 2 Group/ungroup the selected figures and objects by either of the following operations:


Function	Description	Operation	A	F
Group	Multiple figures and objects are grouped.	<ul style="list-style-type: none"> <li>•  (Group)</li> <li>• [Edit] → [Group]</li> </ul>	<input type="radio"/>	<input type="radio"/>
Ungroup	Multiple figures and objects are ungrouped.	<ul style="list-style-type: none"> <li>•  (Ungroup)</li> <li>• [Edit] → [Ungroup]</li> </ul>	<input type="radio"/>	<input type="radio"/>

## 8.2.4 Undo and redo


After deletion or movement of figures and objects, the last operation can be cancelled or repeated. Maximum 500 previous operations can be recorded.


### 1 Undo

The last operation is cancelled.

- Click  (Undo).
- Select the [Edit] → [Undo] from the menu.

### 2 Redo

The last operation is repeated or the operation cancelled with  (Undo) is recovered.









- Click  (Redo).
- Select the [Edit] → [Redo] from the menu.

## 8.2.5 Aligning figures and objects

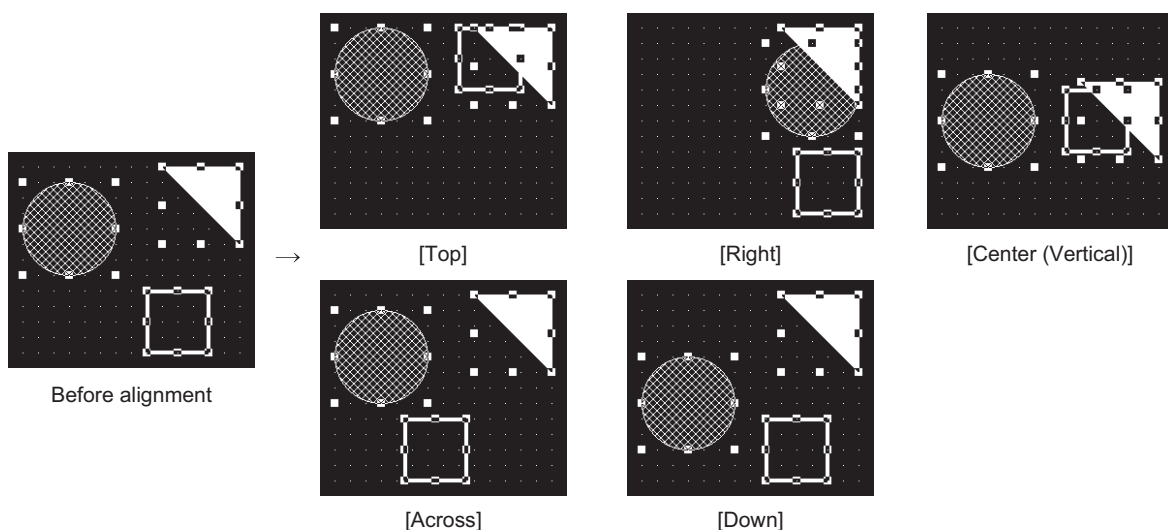
Multiple figures and objects can be aligned in several patterns.

### 1 Aligning in one direction

- 1 Select the desired figures and objects for alignment.
- 2 Perform the following operations according to the alignment:

Function	Description	Operation	A	F
Left	Figures and objects are aligned with the leftmost figure.	<ul style="list-style-type: none"> <li>•  (Align: Left)</li> <li>• [Edit] → [Align] → [Left]</li> </ul>	○	○
Center (Horizontal)	Figures and objects are aligned at the center in the horizontal direction.	<ul style="list-style-type: none"> <li>•  (Align: Center (Horizontal))</li> <li>• [Edit] → [Align] → [Center (Horizontal)]</li> </ul>	○	○
Right	Figures and objects are aligned with the rightmost figure.	<ul style="list-style-type: none"> <li>•  (Align: Right)</li> <li>• [Edit] → [Align] → [Right]</li> </ul>	○	○
Top	Figures and objects are aligned with the uppermost figure.	<ul style="list-style-type: none"> <li>•  (Align: Top)</li> <li>• [Edit] → [Align] → [Top]</li> </ul>	○	○
Center (Vertical)	Figures and objects are aligned at the center in the vertical direction.	<ul style="list-style-type: none"> <li>•  (Align: Center (Vertical))</li> <li>• [Edit] → [Align] → [Center (Vertical)]</li> </ul>	○	○
Bottom	Figures and objects are aligned with the lowermost figure.	<ul style="list-style-type: none"> <li>•  (Align: Bottom)</li> <li>• [Edit] → [Align] → [Bottom]</li> </ul>	○	○
Across	Selected figures are equally aligned in the horizontal direction.	<ul style="list-style-type: none"> <li>•  (Align: Across)</li> <li>• [Edit] → [Align] → [Across]</li> </ul>	○	○
Down	Selected figures are equally aligned in the vertical direction.	<ul style="list-style-type: none"> <li>•  (Align: Down)</li> <li>• [Edit] → [Align] → [Down]</li> </ul>	○	○

(Ex.) Alignment of figures and objects



**Remark**

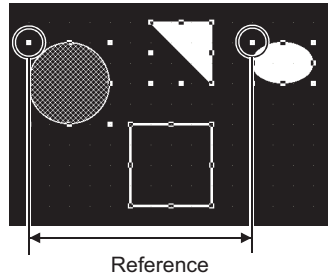
Across and Down

The "Across" function aligns the figures/objects equally based on the top-left coordinates of the leftmost and rightmost figures/objects.

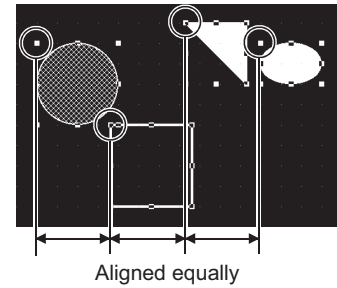
The "Down" function aligns the figures/objects equally based on the top-left coordinates of the uppermost and lowermost figures/objects.

Across

Before alignment

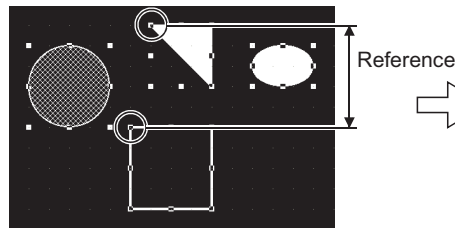


After alignment

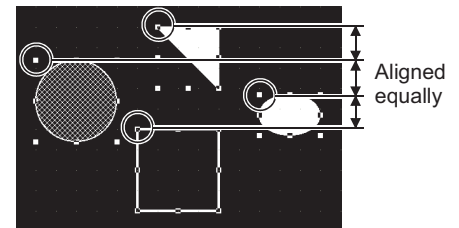



Down


Before alignment




After alignment

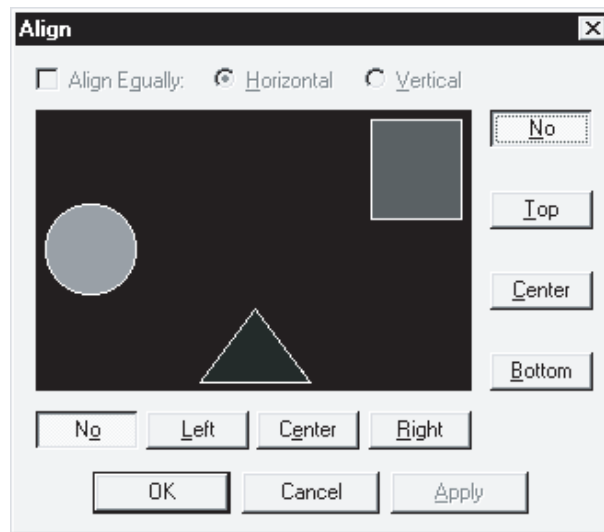


If figures are overlapped by alignment or similar operation, click  (Undo) to reverse the last action.

 Section 8.2.4 Undo and redo

## 2 Alignment in combination of multiple directions

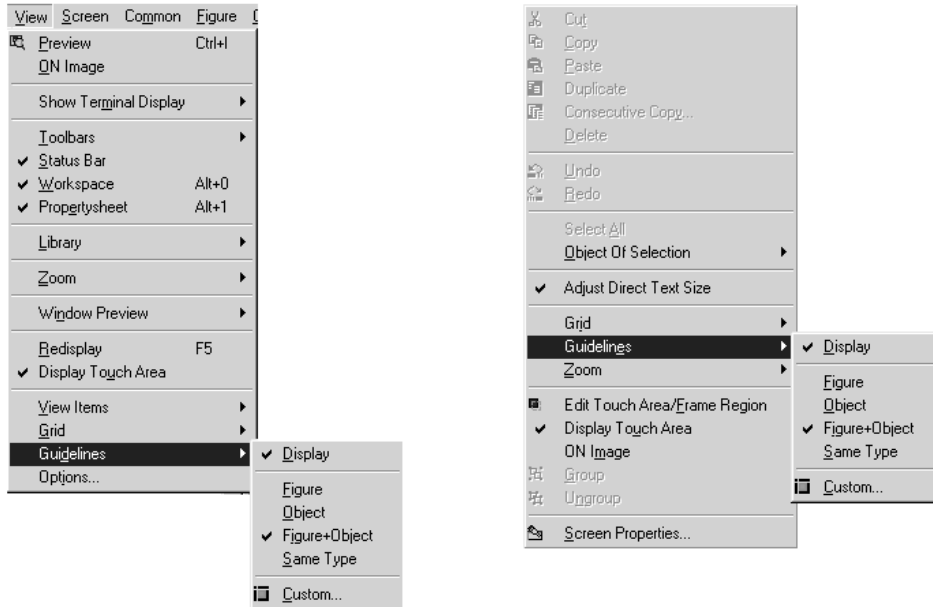
- 1 Select the desired figures and objects for alignment.
- 2 Perform either of the following operations:
  - Click  (Align).
  - Select the [Edit] → [Align] → [Align] from the menu.
- 3 The Align dialog box appears.  
Click any direction button. The image of alignment is displayed.  
Select the direction of alignment, and click the **OK** button.



Item	Description	A	F
No	Alignment is not performed.	<input type="radio"/>	<input type="radio"/>
Top	Figures are aligned with the top figure.	<input type="radio"/>	<input type="radio"/>
Bottom	Figures are aligned with the bottom figure.	<input type="radio"/>	<input type="radio"/>
Left	Figures are aligned with the leftmost figure.	<input type="radio"/>	<input type="radio"/>
Right	Figures are aligned with the rightmost figure.	<input type="radio"/>	<input type="radio"/>
Center	Figures are aligned at the center in the selected direction.	<input type="radio"/>	<input type="radio"/>
Align Equally	Check this to align figures equally. Across: Figures are aligned equally in the horizontal direction. Down: Figures are aligned equally in the vertical direction.	<input type="radio"/>	<input type="radio"/>

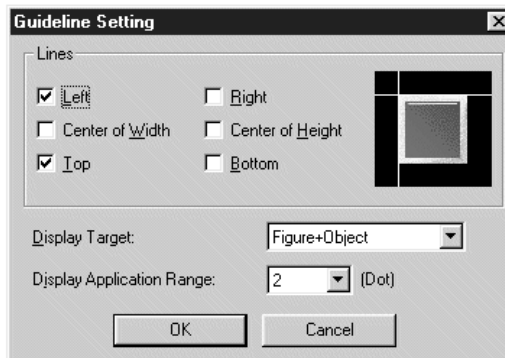
### 3 Alignment using the guideline function

- 1 Select [View] → [Guideline]/[Context menu] → [Guideline] from the menu.



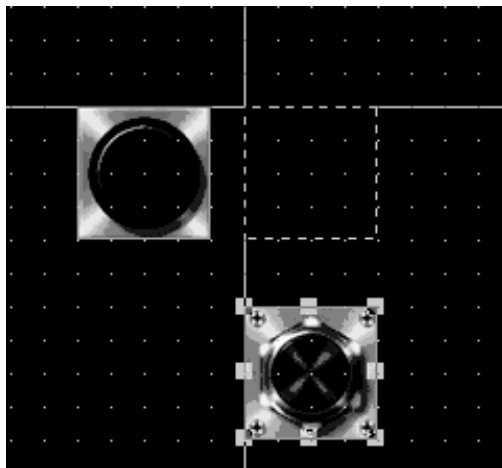
Item	Description
Display	Displays the guideline.
Figure	Select a figure as the display target of the guideline.
Object	Select an object as the display target of the guideline.
Figure and Object	Select a figure and object as the display target of the guideline.
Same type	Select the same type of data as the display target of the guideline.
Custom	Displays the guideline setting dialog box.





Item	Description
Line display	Set the lines to be displayed as the guideline.
Line display target	Select the line display target. The guideline is displayed when the moving figure or object touches the target.
Displaying distance	Specify the displaying distance of the figure or object.

2 Drag and move the figure or object.



### Point

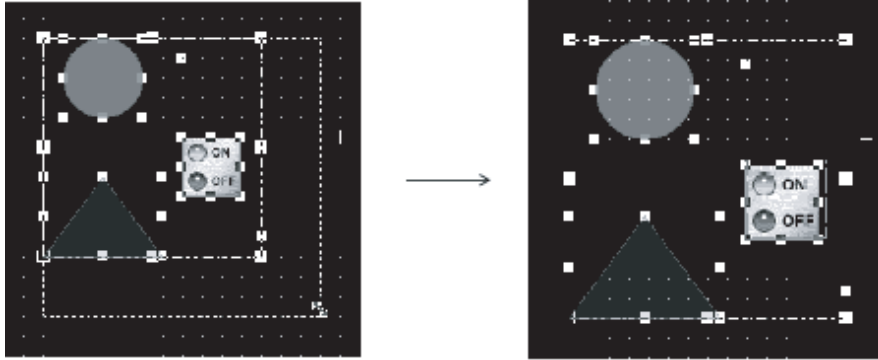
- When the center of width or height is selected, the guideline is displayed at the center of the width or height of the display target.
- The type of grouped figures and objects is "group", and the guideline is displayed for the grouped figures and objects regardless of the contents of the group.
- The touch area of touch switch is not the target of the guideline.
- The guideline is not displayed when operating the keyboard.

## 8.2.6 Enlarging or reducing multiple figures and objects

---

Multiple figures and objects can be enlarged or reduced when they are selected.

- 1 Select the figures and objects to be enlarged or reduced.
- 2 All the selected figures and objects can be enlarged or reduced by dragging the handle.

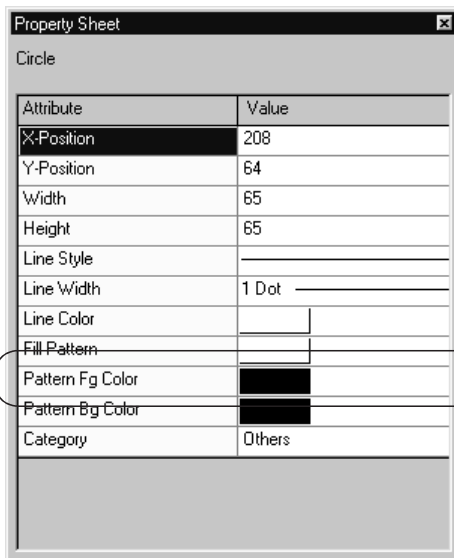


## 8.2.7 Changing attributes of figures and objects

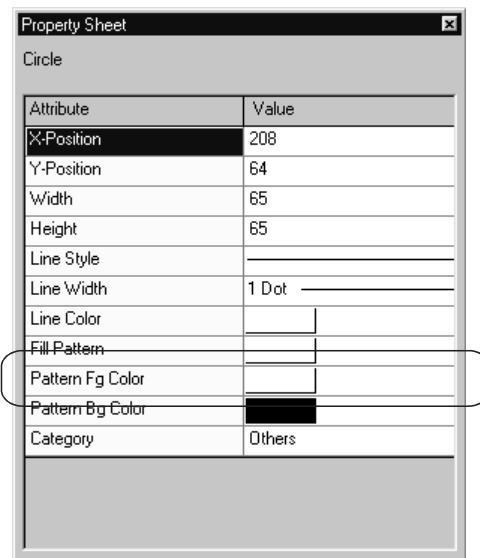
### 1 Changing attributes with property sheet

- 1 Select the desired figure/object.
- 2 Change the attribute of the selected figure/object on the property sheet.

(Ex.) Changing foreground color of a circle from black to white



Changing foreground color



The change is displayed on the figure.

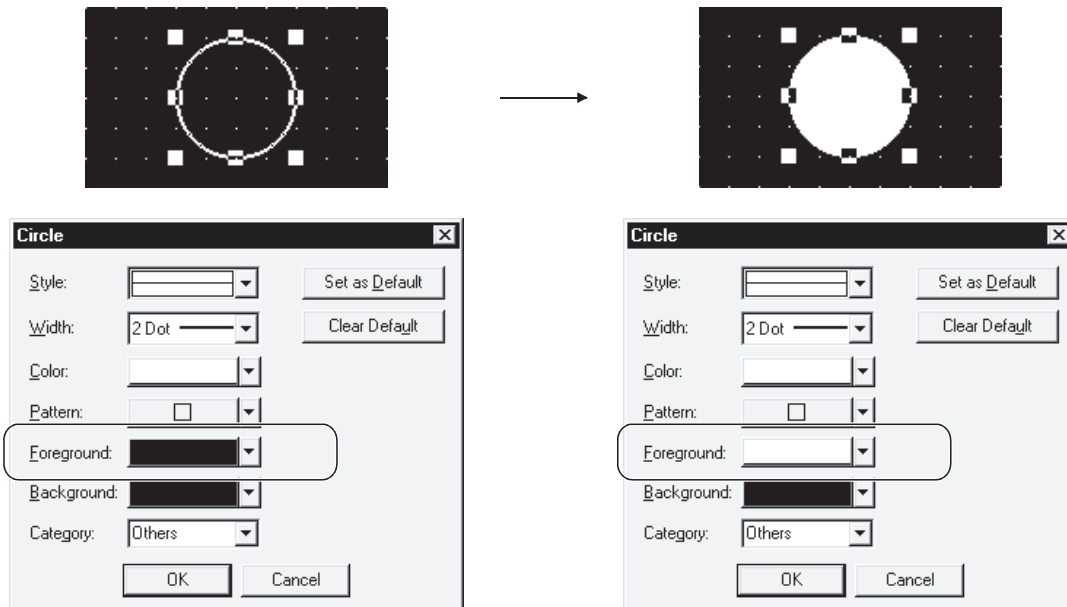
### Remark

- (1) Changing attributes of multiple figures/objects  
Attributes of different types of objects/figures cannot be changed at a time.  
Ex.) Touch switch and lamp  
Bit lamp and word lamp  
Circle and rectangle  
Attributes of grouped objects/figures of different types cannot be changed at a time, either.
- (2) Figure frame of object  
The figure frame of object cannot be set with "Yes/No" on the property sheet.  
Set "Yes/No" of the figure frame by using the dialog box of each object.
- (3) Specify the width in the range of 1 to 2000, and specify the height in the range of 1 to 1600.  
If the value out of the range is specified, an error occurs.

## 2 Changing attribute with dialog box

- 1 Select the desired figure/object.
- 2 Double click on the selected figure/object. The settings dialog box of each figure/object appears. Change attributes there.  
For the settings dialog box of each figure/object, see below:

(Ex.) Changing foreground of a circle from black to white



Change the setting of foreground.

The change is displayed on the figure.

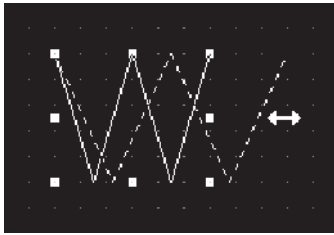
- Settings dialog box of each figure
  - ➔ Section 8.1.1 Drawing figures
- Settings dialog box of object
  - ➔ GT Desinger2 Version□ Reference Manual

## 8.2.8 Changing size of figures/objects

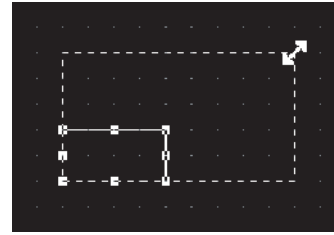
### 1 Changing overall size (scaling up/down)

- 1 Select the desired figure or object.
- 2 Move the cursor to a handle of figure or object. Drag it to change the size of figure or object.

(Ex.) Changing vertical and horizontal sizes



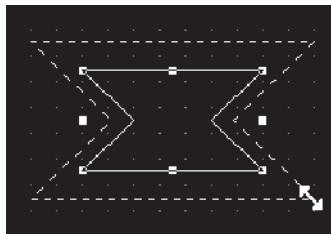
(Ex.) Changing vertical and horizontal sizes from corner



- (1) Operation in combination with the **Ctrl** and **Shift** keys

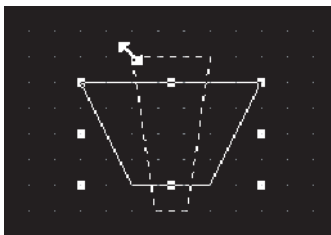
Operation in combination with the **Ctrl** and **Shift** keys allows the following changes of size:

(Ex.) Changing sizes without changing the horizontal to vertical ratio



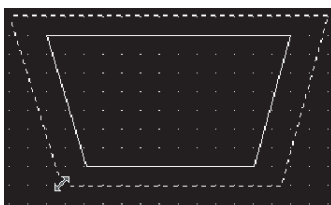
Drag while pressing the **Shift** key.

(Ex.) Changing vertical and horizontal sizes from the center



Drag while pressing the **Ctrl** key.

(Ex.) Changing sizes from the center without changing the horizontal to vertical ratio



Drag while pressing the **Shift** and **Ctrl** keys.


- (2) Changing font size

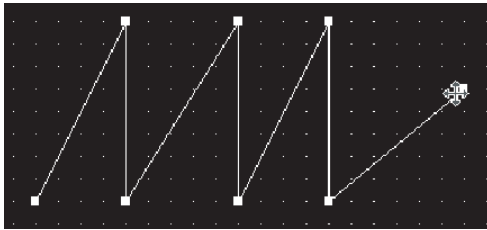
The font size can be changed by the operation above in (1).

However, if the size of the high quality font is multiplied 1, 3, 5 or 7 times, the high quality font setting becomes invalid.

When using the high quality font, set the font size again to 2, 4, 6 or 8 times.

## 2 Changing length of specified side (Edit Vertex)

- 1 Select the desired figure or object.
- 2 Perform either of the following operations to change the handle to the "Edit Vertex" mode:
  - Click  on the toolbars.
  - Select the [Edit] → [Edit Vertex] menu.
- 3 Move the cursor to a handle of the figure. Drag the handle to move the vertex.  
(Ex.) Vertex edit of Line free form



### Adjust Direct Text Size

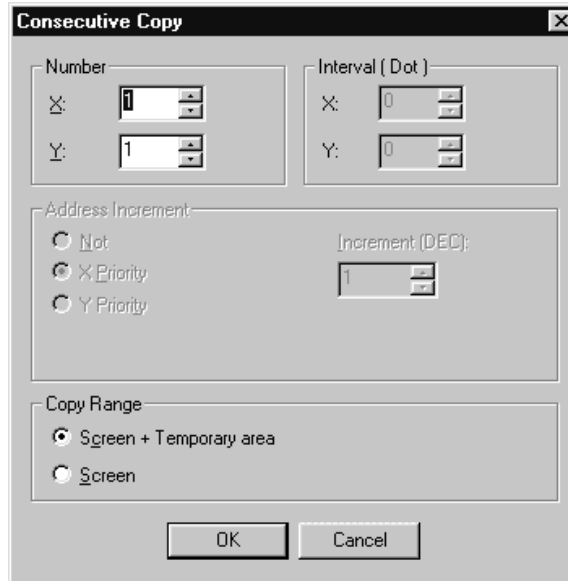
Text size can be automatically adjusted to fit a character string by setting Adjust Direct Text Size.

Refer to the following manual for the target object and setting for Adjust Direct Text Size.

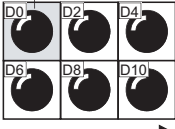
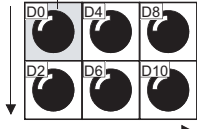
## 8.2.9 Copying figures and objects consecutively

Figures and objects can be copied at a time.

- 1 Select the desired figure or object for consecutive copies.  
(For consecutive copy of multiple figures or objects, select multiple figures/objects at a time.)
- 2 Select the [Edit] → [Consecutive Copy...]/[Context menu] → [Consecutive Copy...] from the menu.  
The consecutive copy dialog box appears.  
After setting the copy details, click the **OK** button to make copies.



Item	Description
Number	The number of figures to be produced after copying and pasting is set. For instance, if the number of copies is set to "2," one selected figure is copied once and two figures are pasted on the screen.  Ex.) Number of copies: 3 in the X direction, 2 in the Y direction
	X direction
Y direction	The number of copies in the Y direction (downward from the source) is set. (1 to 100)
Interval (Dot) *1	The interval (number of dots) between the source and the copy is set for copying.  Ex.) Interval: 5 dots in the X direction
	X direction
Y direction	The interval (number of dots) in the Y direction (down to the copy source) is set. (0 to 100)

Item	Description
Address Increment	<p>It is set to offset the device of the object to the device number for the increments when copying a object. For a touch switch, the write device only for the bit/word operation is applicable.</p> <p>None : Increment is not performed. Priority in the X direction : Incremented in the X direction (right) Priority in the Y direction : Incremented in the Y direction (down)</p> <p>After selecting the priority direction, set the interval to offset the device number. Number of increments (hexadecimal): -10000 to 10000</p> <p>(Ex. 1) Priority in the X direction (Ex. 2) Priority in the Y direction Number of increments: 2 Number of increments: 2</p> <div style="display: flex; justify-content: space-around;"> <div style="text-align: center;"> <p>Copy source</p>  <p>Priority is given to the X direction (right).</p> </div> <div style="text-align: center;"> <p>Copy source</p>  <p>Priority is given to the Y direction (down).</p> </div> </div>

For details of \*1, see below:

\*1 Copying with 0 interval

If a figure/object is copied with 0 interval, the pasted figure/object is overlapped with the source by 1 dot. Set the interval to 1 or more to avoid overlapping of figures or objects.

Ex.)



Copying with 0 interval.



Copying with the interval of 16

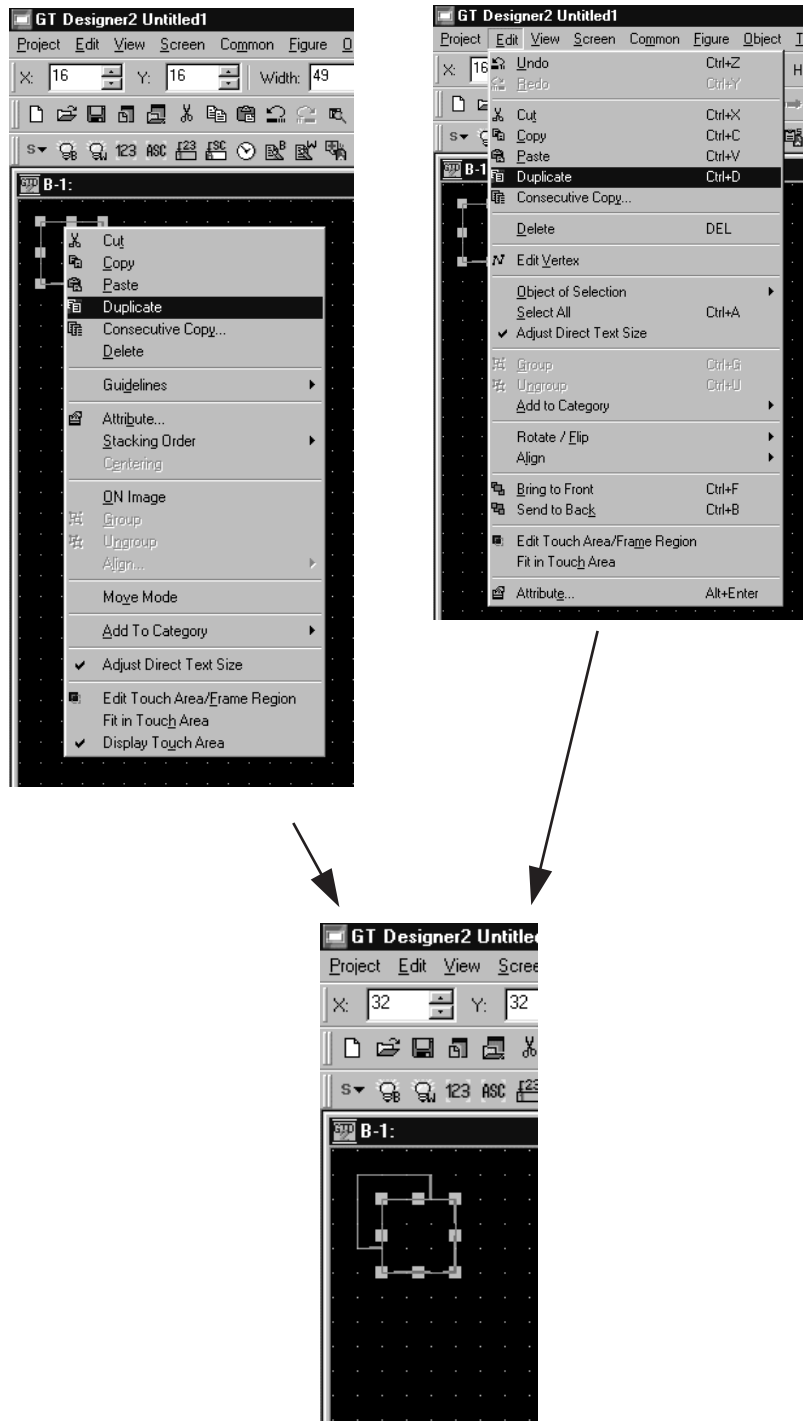
Copy Range	Select the copy range from "Screen + temporary area" and "Screen".
------------	--



## 8.2.10 Copying figures and objects

Figures and objects can be copied at a time.

- 1 Select the desired figure or object for copies.
- 2 Select [Edit] → [Duplicate] menu/[Context menu] → [Duplicate] from the menu.  
When the Copy is selected, copied figure or object is placed.



# 9. USEFUL FUNCTIONS

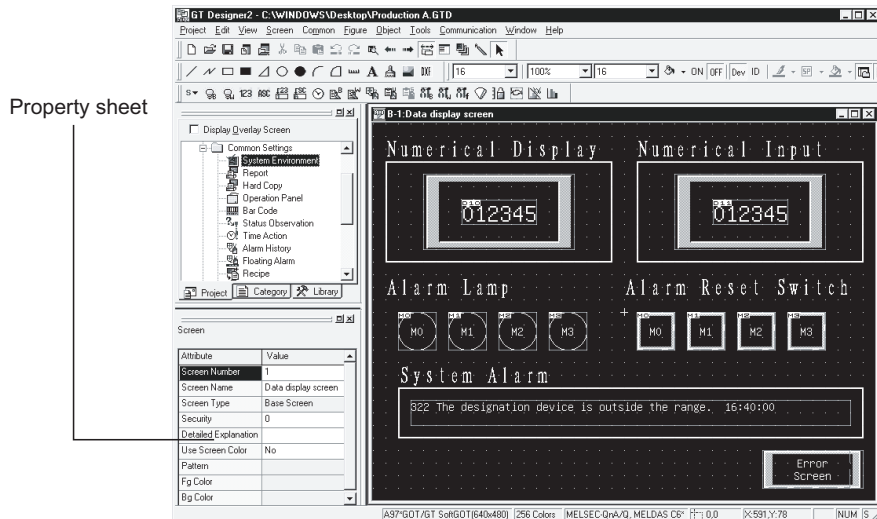
## 9.1 Edit Function

This chapter describes useful edit functions of the GT Designer2.

### 9.1.1 Batch setting of multiple objects/figures on the same screen (Property sheet)

#### 1 What is property sheet?

The property sheet displays all setting items and details of object/figure/screen currently selected in a list. Since the property sheet allows setting of the selected object/figure/screen, the setting details can be checked and set (changed) without opening the dialog box.

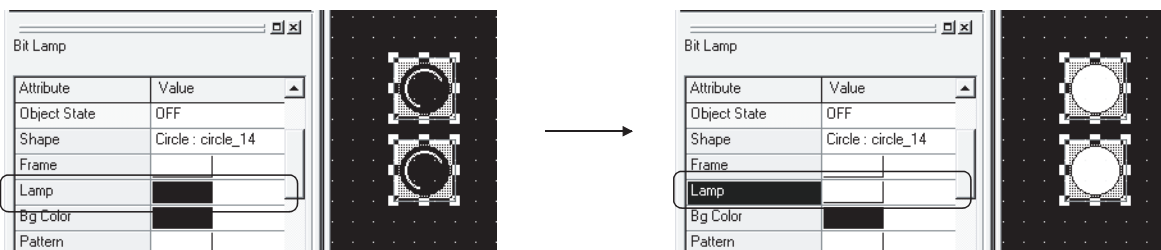


#### 2 Useful for cases below:

It is useful when the setting of multiple objects/figures arranged on the same screen is changed at a time.

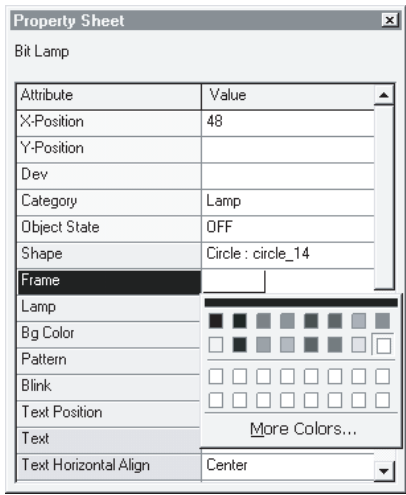
(Ex.) Changing the display color of 2 lamps at a time

Change the setting of the lamp color. The colors of all selected lamps can be changed.



### 3 Operation method

- 1 Select the desired object/figure/screen to change settings. (Multiple objects/figures can be selected.)
- 2 The attributes are displayed on the property sheet. Change the desired attributes.



#### Attribute change

Attributes displayed in the Property Sheet correspond to the setting items of the Object or Figure setting dialog box.

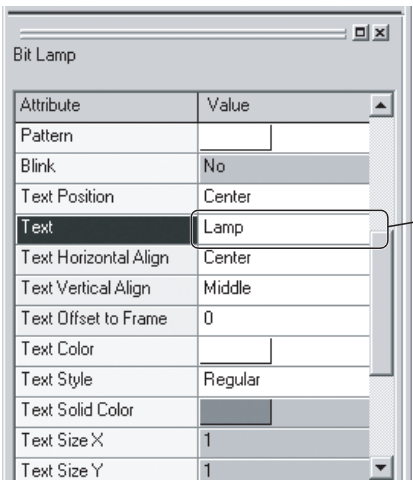
The attributes (setting items) can be set in the same way as the dialog box is set.

For the figure setting items, refer to "Chapter 8 DRAW AND EDIT".

#### (1) Direct input

Some attributes such as text, numerical value and device can be set by direct input.

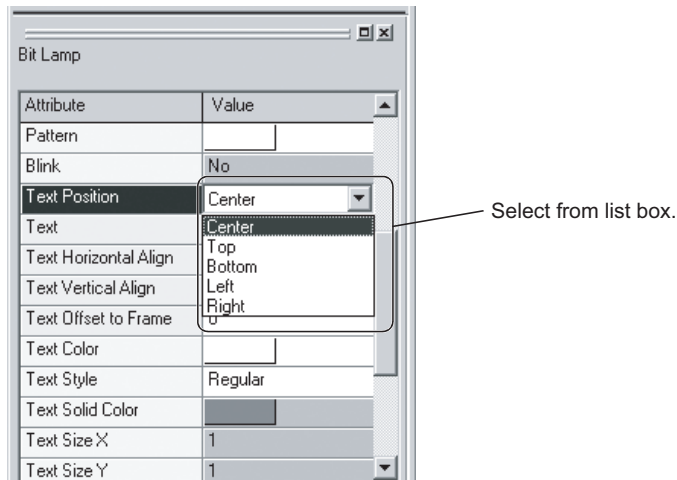
A character string on multiple lines can be entered/edited in the text attribute field, but the first one line of the character string will be displayed in the text filed of the Property Sheet.



Directly enter.

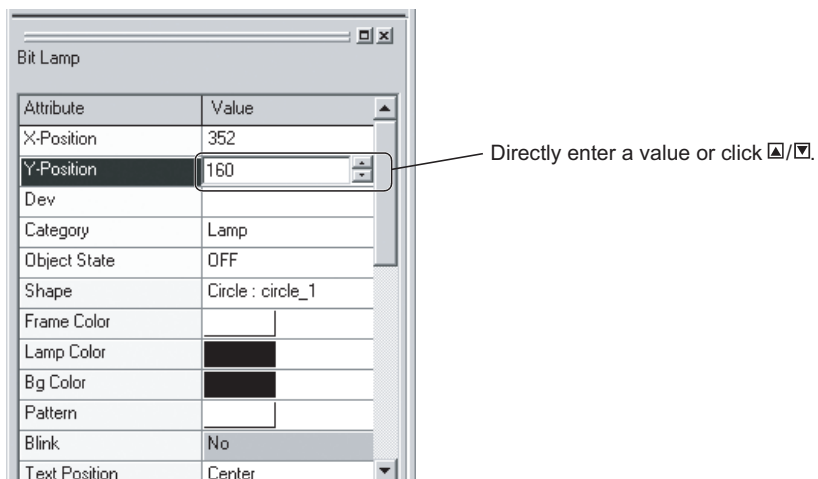
(2) List box

When setting the attributes such as function, color, layer, text size and font, select an option from the displayed list.

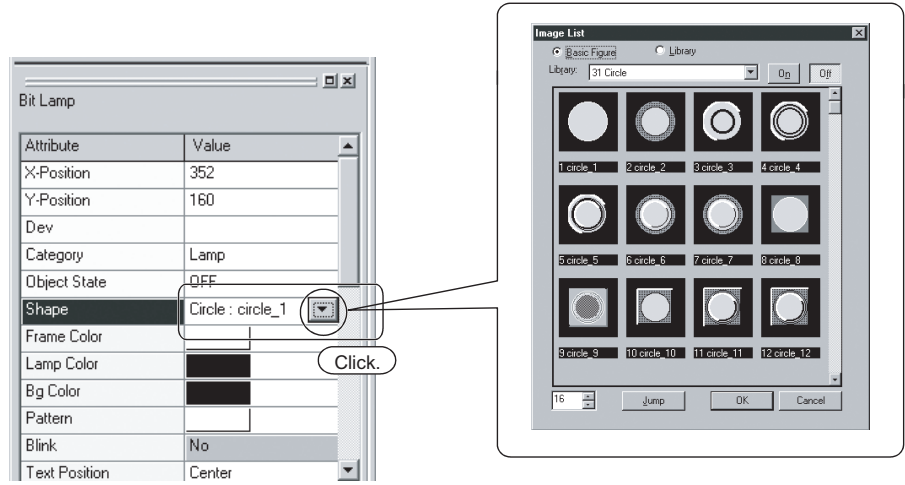


(3) Spin box

When setting the attributes such as coordinates, number of numerical value display digits and security, directly enter a value or select the numerical value by clicking ▲ / ▼.



- (4) Dialog box  
 When setting the attributes such as device and figure, select an option from the displayed dialog box.



**4** Precautions

- (1) Different types of objects/figures cannot be checked/set at a time.  
 Ex.: Touch switch and lamp  
     Bit lamp and word lamp  
     Circle and rectangle  
 Different types of grouped objects/figures cannot be checked/set at a time.
- (2) Objects/figures distributed on multiple screens cannot be checked/set.



**Batch editing objects/figures scattered on multiple screens**

Use of batch edit allows change of attributes (color, device, etc.) in batch that are different in types or scattered on multiple screens.

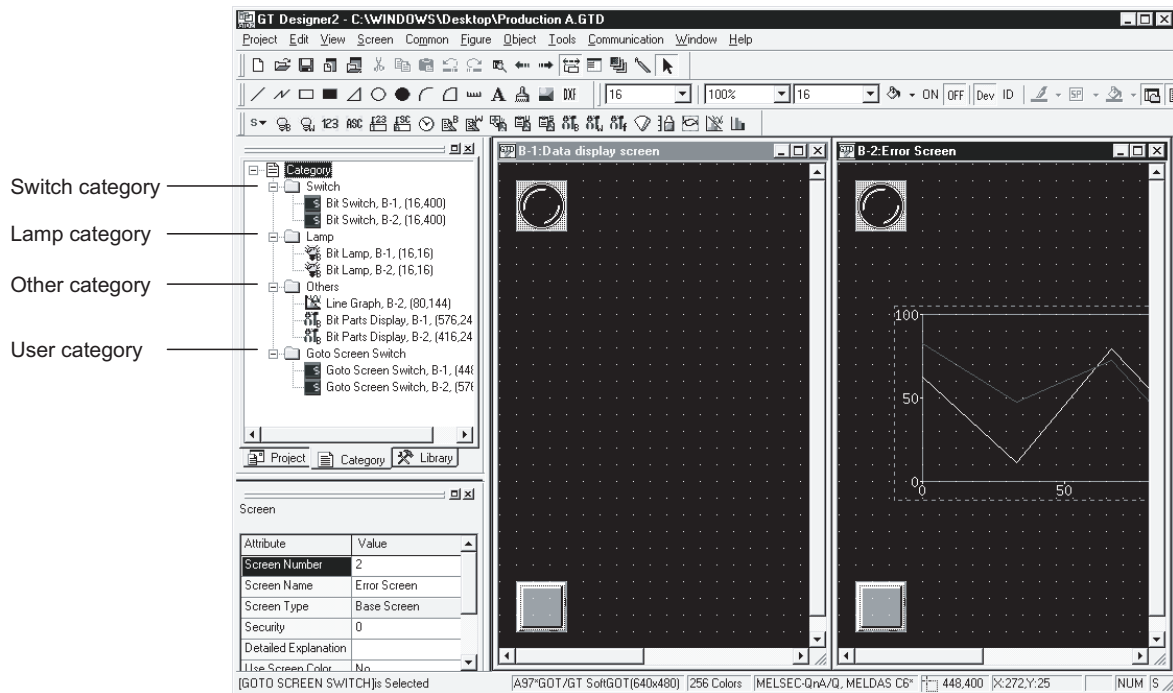
☞ Section 9.1.3 Batch editing attributes of objects/figures scattered on multiple screens (Batch edit)

- (3) The property sheet makes the settings of all selected objects and figures same. Note that if different devices has been set for each object, using the property sheet will change the settings of all selected objects to the same device.
- (4) The figure frame of the object cannot be set with "Yes/No" on the property sheet. Set "Yes/No" of the figure frame by using the dialog box of each object.

## 9.1.2 Batch setting and managing objects/figures for each purpose (Category workspace)

### 1 What is Category?

The set objects/figures are stored in any of the following categories: Switch, Lamp and Others. Sorting objects and figures into the user category for each application allows management of objects and figures.



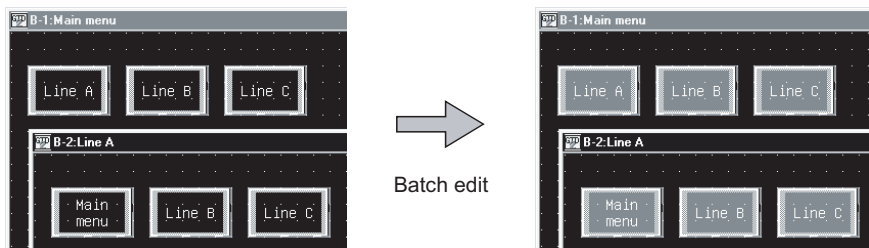
Category	Description
Switch category	Stores all objects and figures set as "Switch". By default, all touch switches are included.
Lamp category	Stores all objects and figures set as "Lamp". By default, all lamp displays are included.
Other category	Stores all objects and figures set as "Others". By default, objects and figures other than the touch switches and lamp displays are included.
User category	It is a category created by the user. Objects stored in the switch, lamp, other categories can be moved to the user category and categories can be created for each application.

**2** Convenient for the case below:

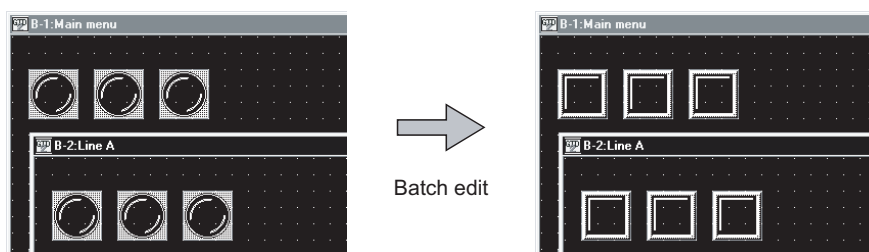
Color/device of the Goto screen switch can be changed in batch. It is convenient to make batch edit for each purpose.

Figures of the touch switch or the lamp can be changed in batch.

Ex. 1) Batch editing display color of Goto screen switch



Ex. 2) Batch editing lamp figure

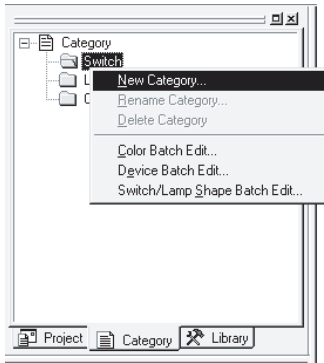


### 3 Creating user category

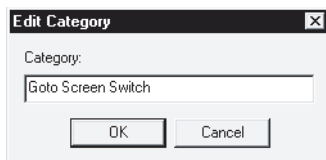
The method to create a user category is shown below:

In this section, an example of category creation for the Goto Screen switch is described.

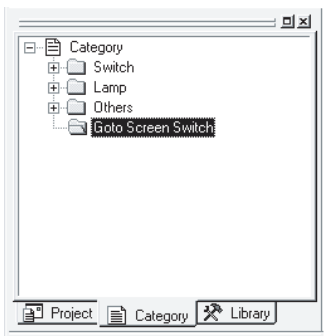
- 1 Select a category from Switch, Lamp and Others. Right click the mouse and select "New Category".



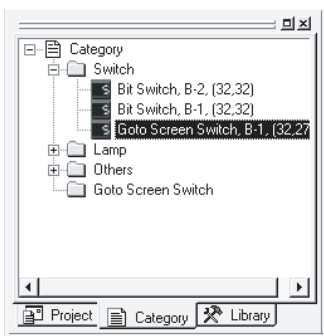
- 2 The Edit Category dialog box appears. Enter the category name (enter "Goto Screen Switch" here). Click the **OK** button. The dialog box is closed.



- 3 The user category is added.

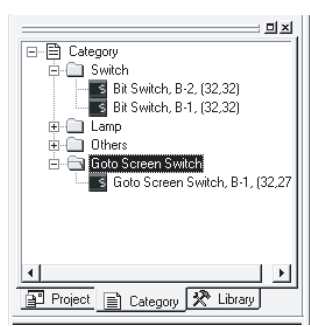


- 4 Select the Goto Screen switch under the switch category and drag it to the Goto Screen Switch category.



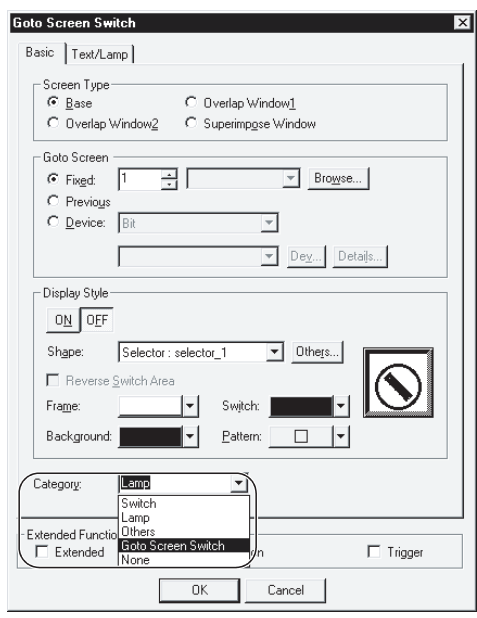


5 The Goto Screen switch is stored in the Goto Screen Switch category.



Category registration of objects and figures

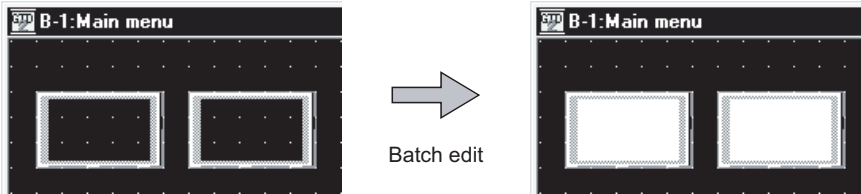
Create a user category first. The created user category can be selected when setting the storage location of objects and figures.



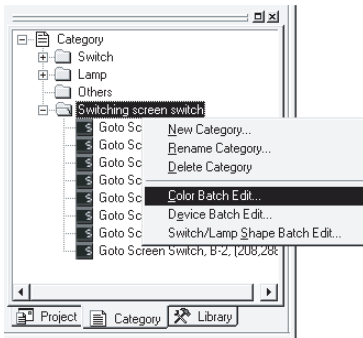
#### 4 Method to make batch settings for each category

Batch setting method of a category is described.

An example of batch editing the switch color in the Goto screen switch category from black to white is shown here.

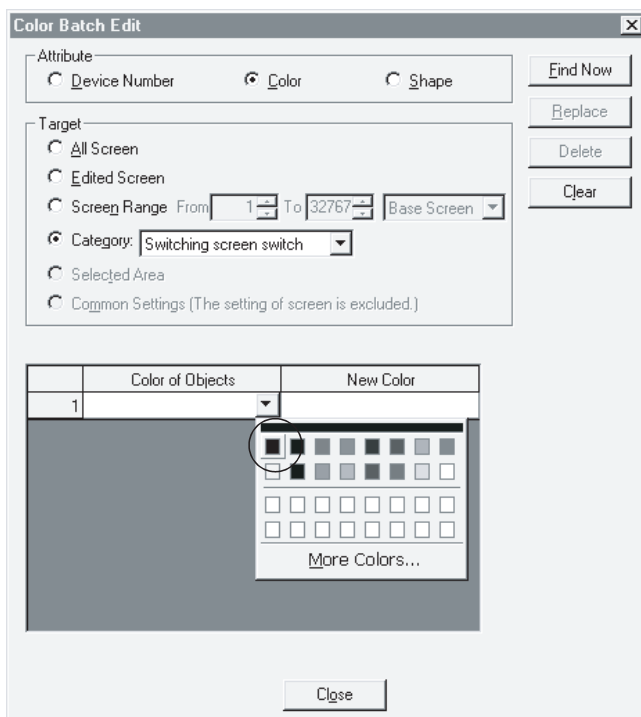


- 1 Select the desired category for batch edit and right click the mouse to select [Color Batch Edit].

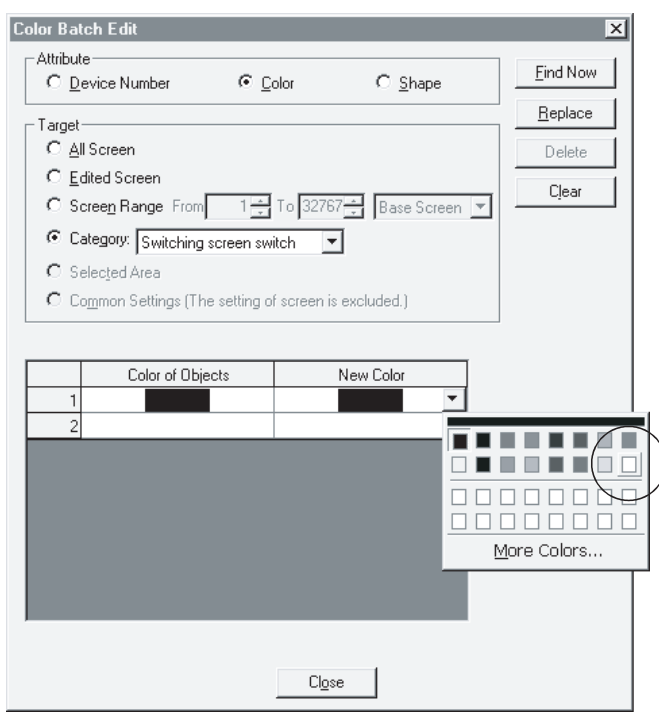


- 2 The batch edit dialog box appears. Specify the color (black) before change. Refer to the following for details of the batch edit dialog box.

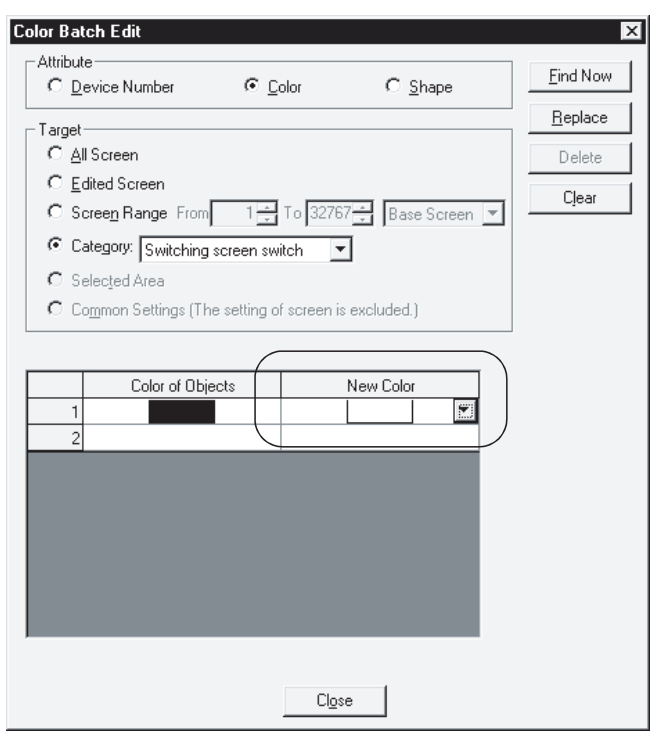
Section 9.1.3 Batch editing attributes of objects/figures scattered on multiple screens (Batch edit)



3 Specify the color (white) after change.



4 Click the **Replace** button. The color is changed to the specified color. Click the **Close** button to close the dialog box.





- (1) **Find Now** button

Click the **Find Now** button to display all colors used in the category.  
It is convenient to batch edit multiple devices/colors/figures.

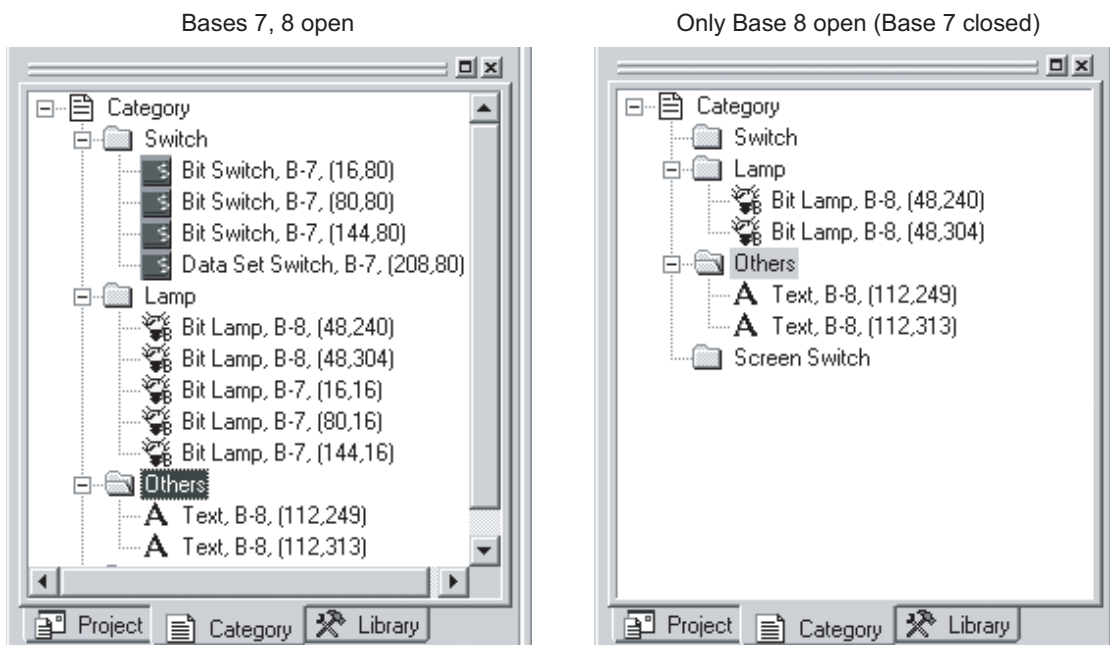
- (2) Target other than category

Other than categories, screens or common settings can be batch edited.

☞ Section 9.1.3 Batch editing attributes of objects/figures scattered on multiple screens (Batch edit)

## 5 Precautions

- (1) The categories set on a closed screen are not displayed.



- (2) One object/figure cannot be stored in multiple categories.
- (3) Multiple attributes cannot be batch edited. (Ex.: Batch edit of device and color)
- (4) Refer to the precautions of batch edit before change.

☞ Section 9.1.3 Batch editing attributes of objects/figures scattered on multiple screens (Batch edit)

## 9.1.3 Batch editing attributes of objects/figures scattered on multiple screens (Batch edit)

### 1 What is batch edit?

Color or other attributes of objects/figures are changed in batch.

The following attributes can be batch edited:

- Device of object
- Color of object/figure
- Figure used for lamp display/touch switch

### 2 Convenient for the case below:

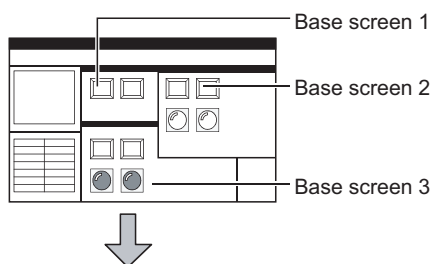
It is convenient to batch edit device, color or lamp/switch figure of objects or figures scattered on multiple screens.

Different types of figures (circle and rectangle) or object (touch switch and value display) can be batch edited.

The following types of batch edit are available.

Each change method and image after change are shown below.

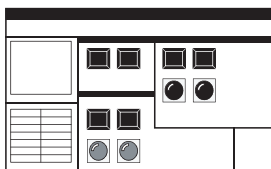
<Image before change>



<Image after change>

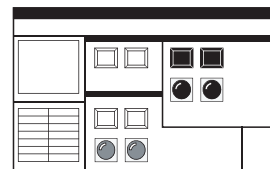
Batch editing all screens (Change of color:  → )

Color of objects/figures on all screens (Base screen 1, Base screen 2, Base screen 3) is batch edited.



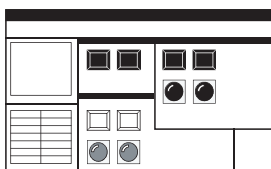
Batch editing screen (Change of color:  → )

Color of objects/figures on the editing screen (Base screen 2) is batch edited.



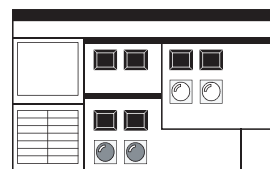
Batch editing specified screens (Change of color:  → )

Color of objects/figures on screens for the specified numbers (Base screen 1 to Base screen 2) is batch edited.



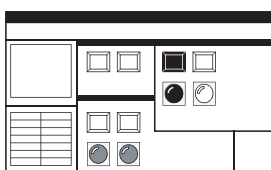
Batch editing each category (Change of color:  → )

Color of the specified category (Goto screen switch) is batch edited.



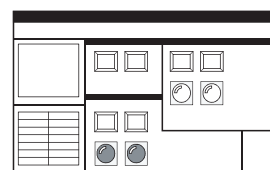
Batch editing selected areas (Change of color:  → )

Color of objects/figures on the selected area in the editing screen is batch edited.



Batch editing common settings (Change of device)

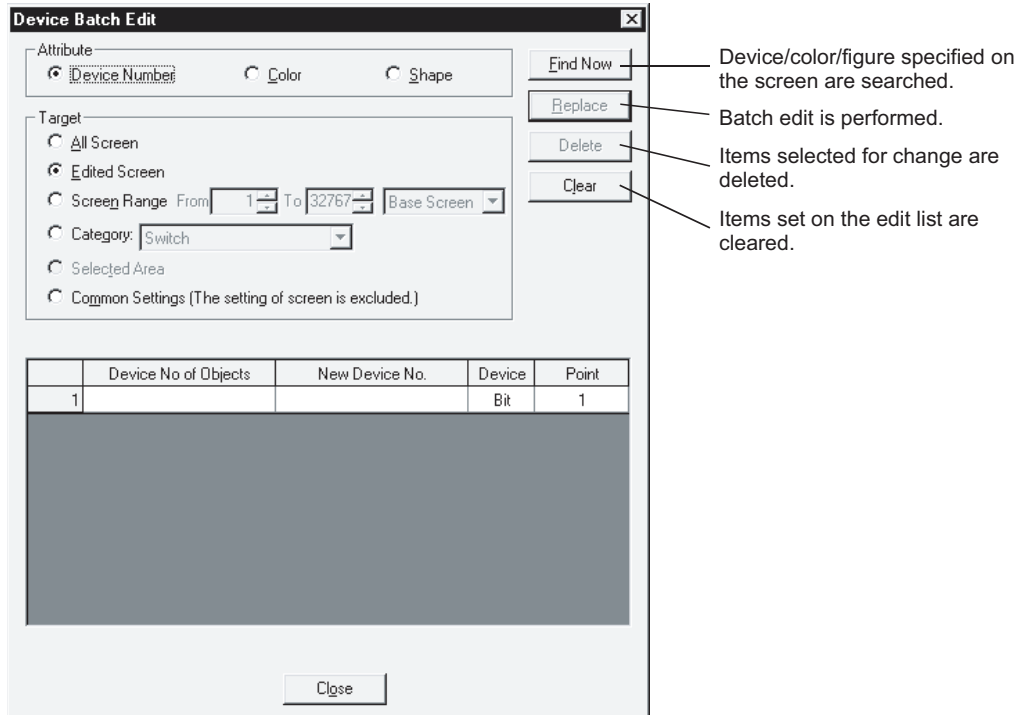
Devices (Switching screen device, start trigger device of hard copy, etc.) set in the common settings are batch edited.



### 3 Operation method

The batch edit method is described.

- 1 Select the [Tools] - [Batch Edit] - [Device Batch Edit/Switch Lamp Shape Batch Edit/Color Batch Edit] menu.
- 2 The setting dialog box appears. Refer to the following descriptions for setting.



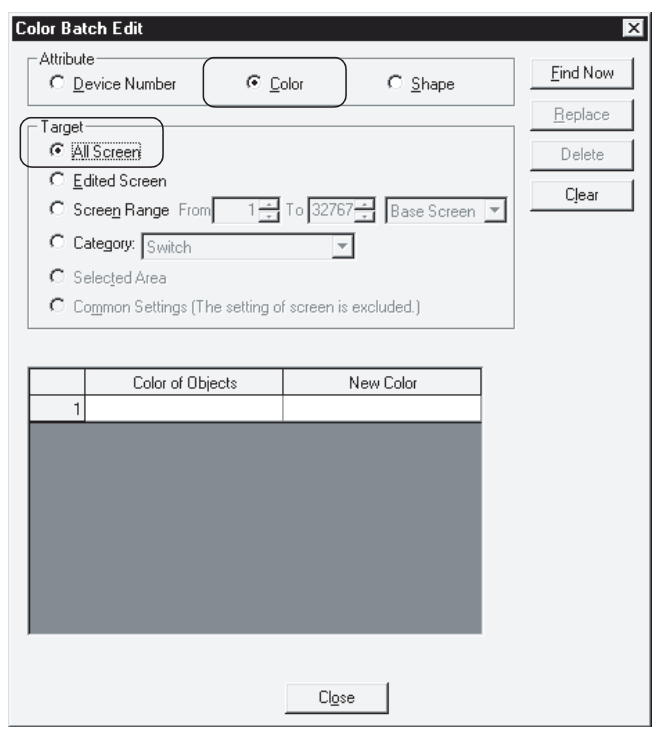
Item	Description	A	F
Attribute	Attribute for batch edit is selected. Device number : Device number is batch edited. Color : Color is batch edited. Shape : Figures of touch switch or lamp are edited.	<input type="radio"/>	<input type="radio"/>
Target *1	Unit for batch edit is selected. All Screen (including screen status monitoring) : All screens are the target for batch edit. Edited Screen (including screen status monitoring) : The editing screen is the target for batch edit. Screen Range : The specified screen is the target for batch edit. After selection, the range and the type on the screen are specified. Category : Category is the target for batch edit. After selection, select the category for batch edit. Selected Area : Objects/figures selected on the editing screen are the target for batch edit. Common Settings : Common Settings are the target for batch edit.	<input type="radio"/>	<input type="radio"/>
Edit list	Attributes to be changed are set. When figures are selected by attributes, switch figures and lamp figures can be classified for setting. Device No of Objects : Device/color/figure before change is selected. New Device No. : Device/color/figure after change is selected. Device : Device type (bit/word) is selected for batch edit of device. Point : Points are set for consecutive edit of devices. (In Device No of Objects: M0/New Device No.: M10, set 4. M0 to M4 are changed to M4 to M10.)	<input type="radio"/>	<input type="radio"/>

**4 Method of batch edit**

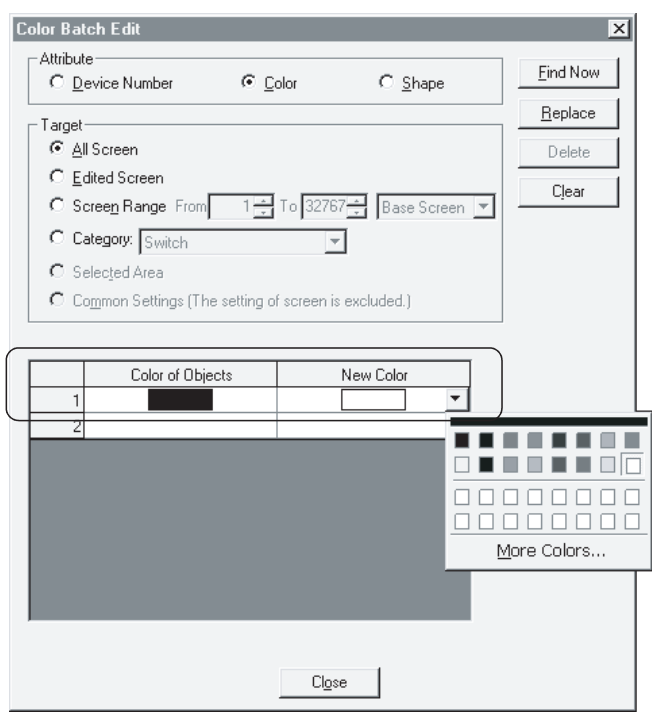
Method of batch edit is explained.

An example to change the color of objects or figures set on all screens from black to white is described here.

- 1 Display the device batch edit dialog box. Select "Color" from "Attribute" and "All screen" from "Target."



- 2 Select black from "Color of Objects" and select white from "New Color."





button

Click the  button to display all devices/colors/figures (either one only) used in all screens.

It is convenient to batch edit multiple devices/colors/figures.

- 3 After selection, click the  button. Items set in black are changed to white.

## 5 Precautions

### (1) Change of device

- (a) When the device format (bit device, word device, bit specification for word device) is specified, the device cannot be changed to a different device type.
- (b) The object device with the specified offset device cannot be changed to the word specification for bit device.
- (c) When the head device of the device which is automatically and consecutively set is changed, do not make the data length out of the device range.  
The following operation occurs depending on the device data length.
  - When the data length is 16 bits and the set device is out of the range, the device is not changed.
  - When the data length is 32 bits and the set device is out of the range, the area out of the device range is not set for the device.
- (d) Scripts cannot be changed with the use of "Replace Devices".

### (2) Change of figure

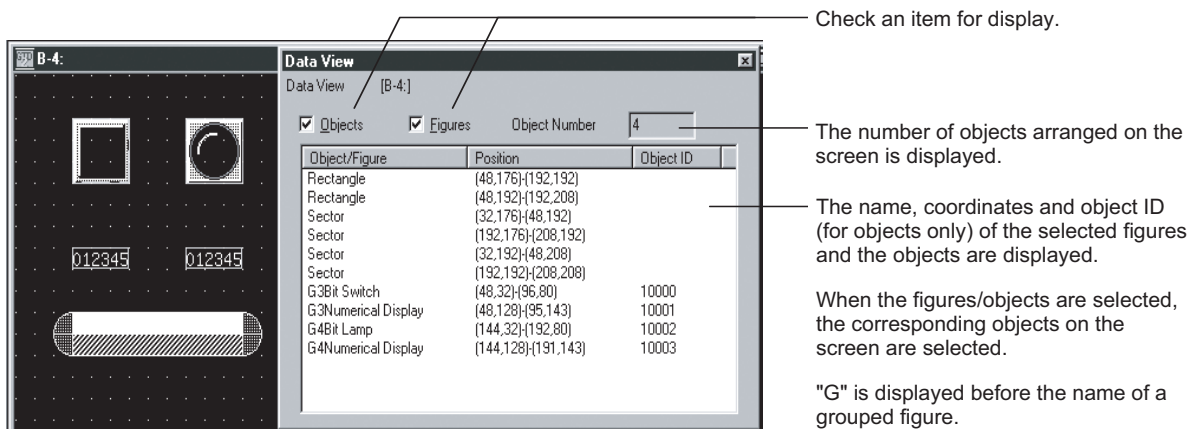
- (a) Change from a basic figure to a free figure and from a free figure to a basic figure is not allowed.



## 9.1.4 Simple selection of overlapped figure (Data view)

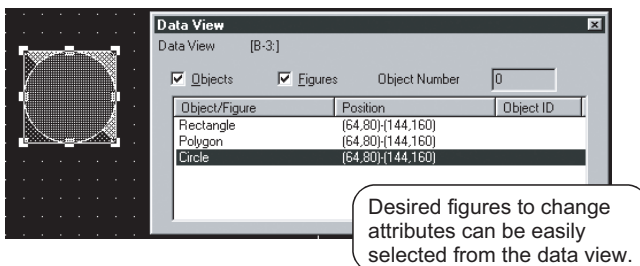
### 1 What is data view?

The data view displays all figures and objects arranged on the screen in a list.  
The listed figures and objects can be double clicked and edited directly.



### 2 Useful for cases below:

If multiple objects or figures are overlapped, desired figures or objects can be easily selected and edited.



### 3 Operation method

- 1 Select the [Tool] → [Data View] from the menu.
- 2 The data view is displayed.
- 3 Double-click the object/figure to be edited from the data list.



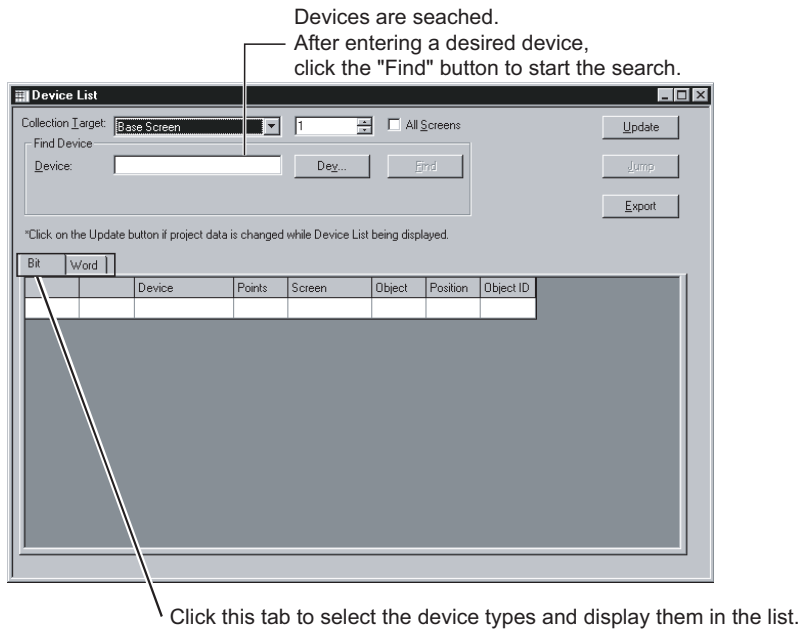
#### Point Individual settings for grouped objects

Grouped objects selected from the data list can have individual settings changed without ungrouping.

## 9.1.5 Checking devices in use (Device List)

### 1 Device List

The device list displays the devices used for the editing screen or the entire project.



### 2 Useful for cases below:

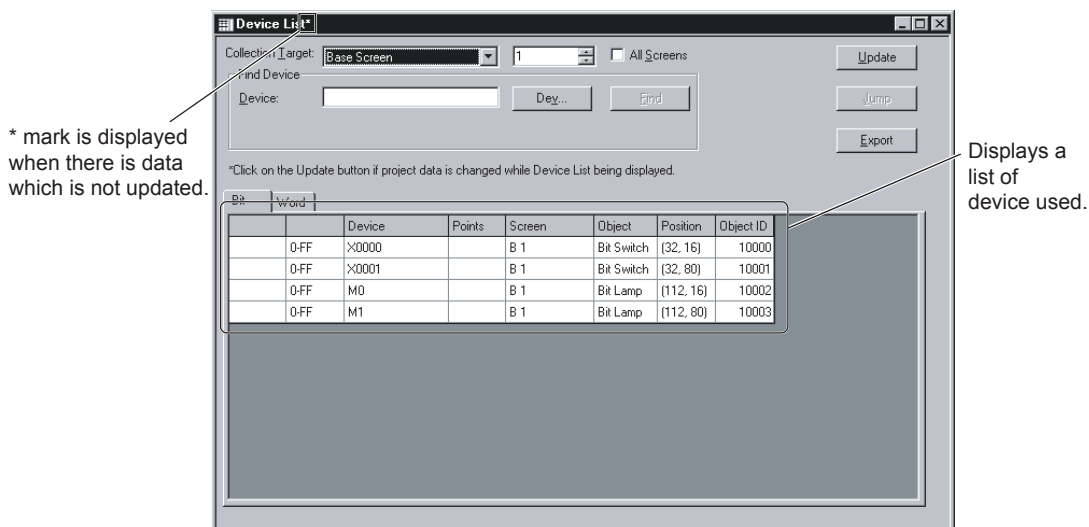
The Device List is useful to check devices used for the project/screen created.

### 3 Operation method

#### 1 Select the [Tool] → [Device List] → [Screen/Project].

- When the [Screen...] is selected, the collection target is Base Screen.
- When the [Project...] is selected, the collection target is the whole Project.

#### 2 The Device List is displayed. Check the devices used.



Item	Description
Collection Target	The display target is selected from [Project], [Base Screen], [Window Screen], and [Report Screen]. (When the [Project] is selected, Screen No. and all screen check box are disabled.)
Screen NO.	The screen NO. to be searched is specified from 1 to 32767 (from 1 to 8 for only Report Screen).
All Screens check Box	All screens of the Screen Type that are selected in the collection target are the objects.
Update button	The list information is updated.
Jump button	The specified setting screen is opened, and the object is pointed with a cursor. Jump button is enabled when a line is selected in the list.
Export button	The Device List currently displayed is output to the CSV or Unicode Text file.
Find button	When the device is set, and when the return key or the Find button is pressed, the search is performed.



#### When using the Device List

- Devices in the script cannot be displayed as a device list.
- Object ID misplacement

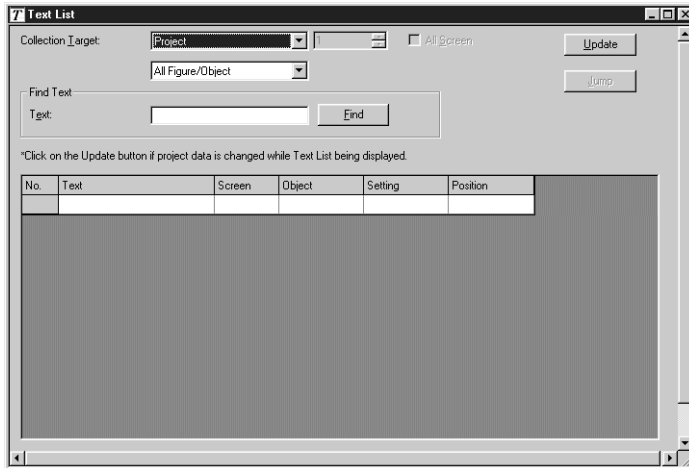
After the objects on the screen are erased, or the order of the objects are changed, if the Jump is performed without updating the device list, an error that the cursor jumps to the different object may occur.

## 9.1.6 Checking Text in use (Text String List)

---

### 1 Text List

The Text List displays the direct text setting by the refining setting. The specific figure or object can be selected by the jump function.

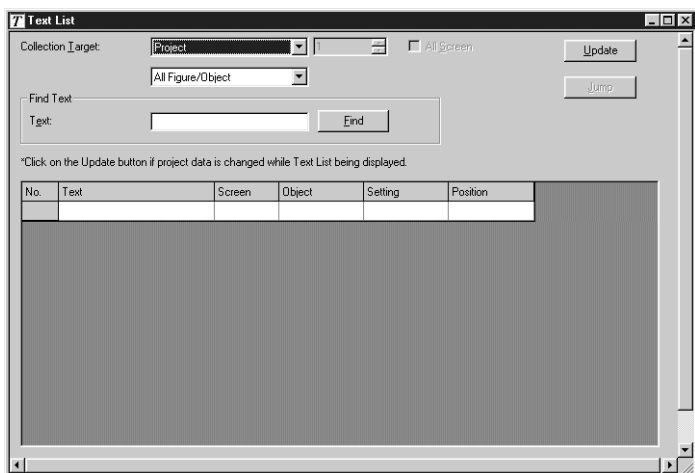


### 2 Useful for cases below:

The Text List is useful to check and search direct text settings used for the project/screen created.

### 3 Operation method

- 1 Select the [Tools] → [Character String List].
- 2 The Character String List is displayed. Check the devices used.

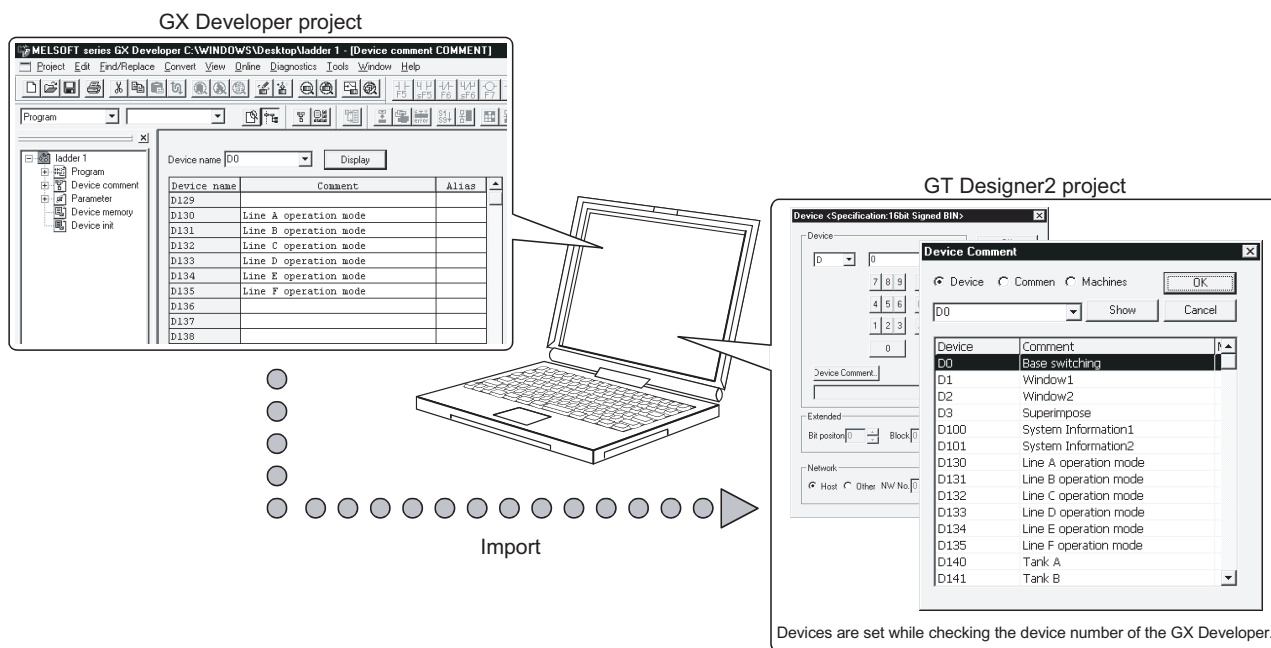


Item	Description
Collection Target	The display target is selected from [Project], [Base Screen], [Window Screen], [Report Screen], [Parts], and [User Library].
Screen NO.	For [Base Screen], [Window Screen], and [Parts], the screen NO. to be searched is specified from 1 to 32767. For [Report Screen], the screen NO. to be searched is specified from 1 to 8. For [User Library], the screen NO. to be searched is specified from 1 to 250.
All Screens check box *1	All screens of the Screen Type that are selected in the collection target are the objects.
Update button	The list information is updated.
Jump button	The specified setting screen is opened, and the object is pointed with a cursor. Jump button is enabled when a line is selected in the list.
Find target 2	The target to be displayed in the list is refined.
Find button	When the device is set, and when the return key or the Find button is pressed, the search is performed.

\*1 When the [User Library] is selected, the name becomes [All User Library (S) (0: Including My Favorites)].

## 9.2 Referring to Device Comment When Setting Devices

The device comment and the device name created on the GX Developer can be checked when setting devices on the GT Designer2. Since devices can be set on the GT Designer2 while checking the devices used for the PLC program, errors in device number setting can be prevented. (Only for GOT-A900 Series)



PC types available for the device comment check

The device comment of the GX Developer can be checked when the PC type is "MELSEC-A", "MELSEC-QnA, Q", "MELSEC-Q (Multi)" or "MELSEC-FX".

### 9.2.1 Importing device comment

Import the device comment of the GX Developer to the GT Designer2 in order to check the device on the GT Designer2.

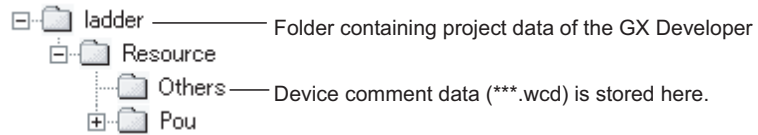
- 1 Select the [Project] → [Import Device Comment of GX Developer] from the menu.
- 2 The "Import Device Comment of GX Developer" dialog box appears. Specify the device comment file in the project of the GX Developer.  
Click the **OK** button. Import of device comment is completed.



Clicking the **Delete** button of the "Import Device Comment of GX Developer" dialog box will delete the path of the current device comment data.

- (1) GX Developer data used for this function  
Only the device comment data (\*\*\*.wcd) of the GX Developer is required for this function.  
Other project data of the GX Developer is not required.

- (2) Storage location of device comment data  
The device comment data (\*\*\*.wcd) of the GX Developer is created in the project data of GX Developer.

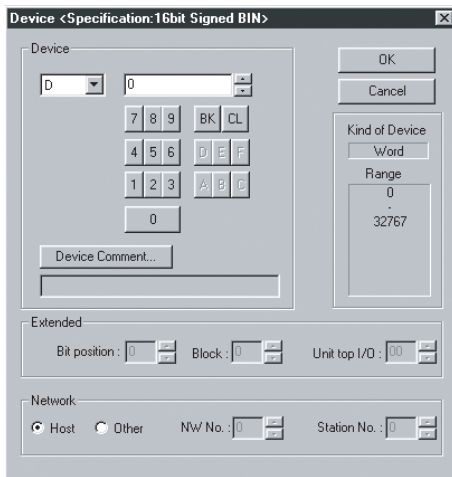


- (3) Modification of device comment on the GX Developer  
If the device comment data (\*\*\*.wcd) once specified is edited on the GX Developer, it is not updated on the GT Designer2.  
To update the edition, specify the device comment data (\*\*\*.wcd) again.
- (4) Specified path  
The path is stored after the GT Desiner2 is completed.

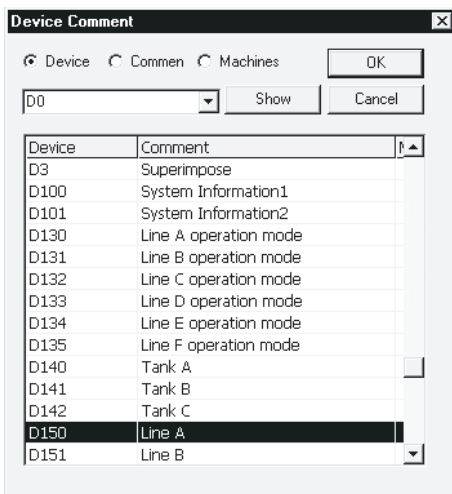
## 9.2.2 Check method of device comment

The check method of device comment is shown below:

- 1 Click the **Device Comment...** button in the device settings dialog box of each object.



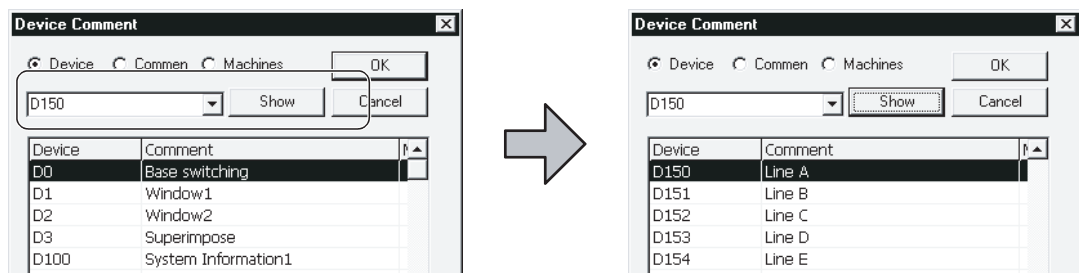
- 2 The device comment dialog box appears. A device can be set while checking the device comment. After setting, click the **OK** button.



In the device comment dialog box, device number, comments and device names can be used for search.

(Ex. 1) Search of device number

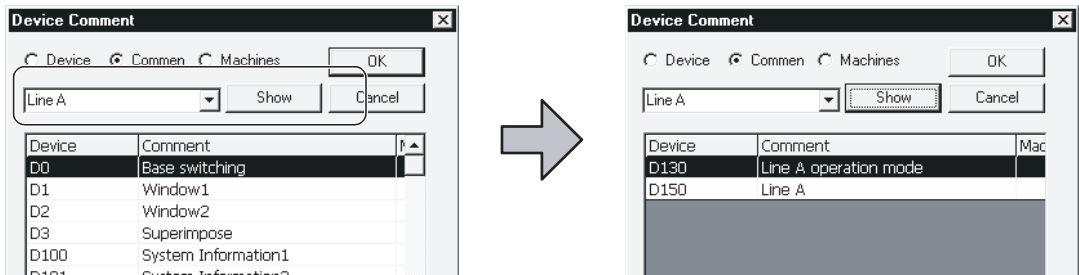
After entering a desired device number, click the **Show** button. The corresponding device is displayed at the top of the list.



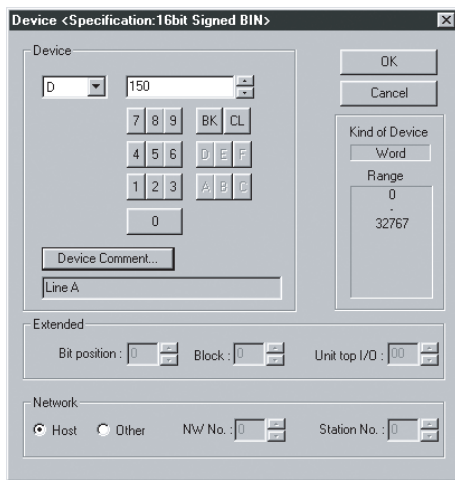


(Ex. 2) Search of comment/device name

Enter a desired keyword and click the **Show** button. The comment or the device name containing the entered keyword are displayed in the list.




3 The device comment dialog box is closed. The selected device is set in the device setting dialog box.



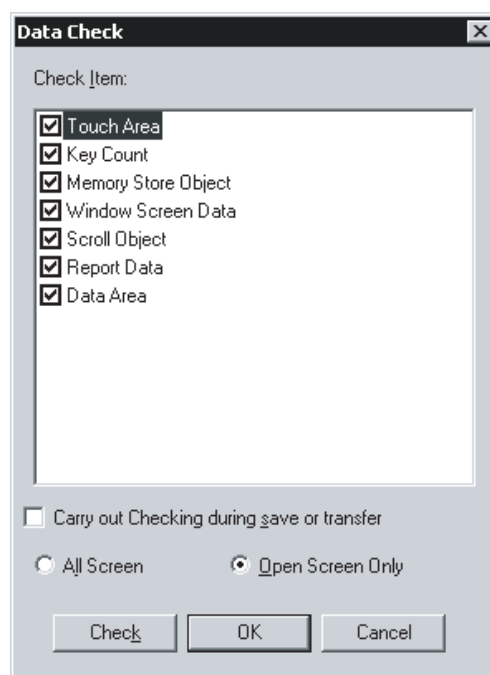
## 9.3 Checking Monitor Data for Errors

---

Details of the monitor screen data created on the GT Designer2 can be checked for errors. For the checking method, see below:

 Section 4.13 Data Check

- 1 Open all screens to be checked.  
The unopened screens are not checked.
- 2 Choose the [Tools] → [Data Check...] menu.
- 3 The Data Check dialog box appears.  
Set the data check items and click the **Check** button to execute a data check.

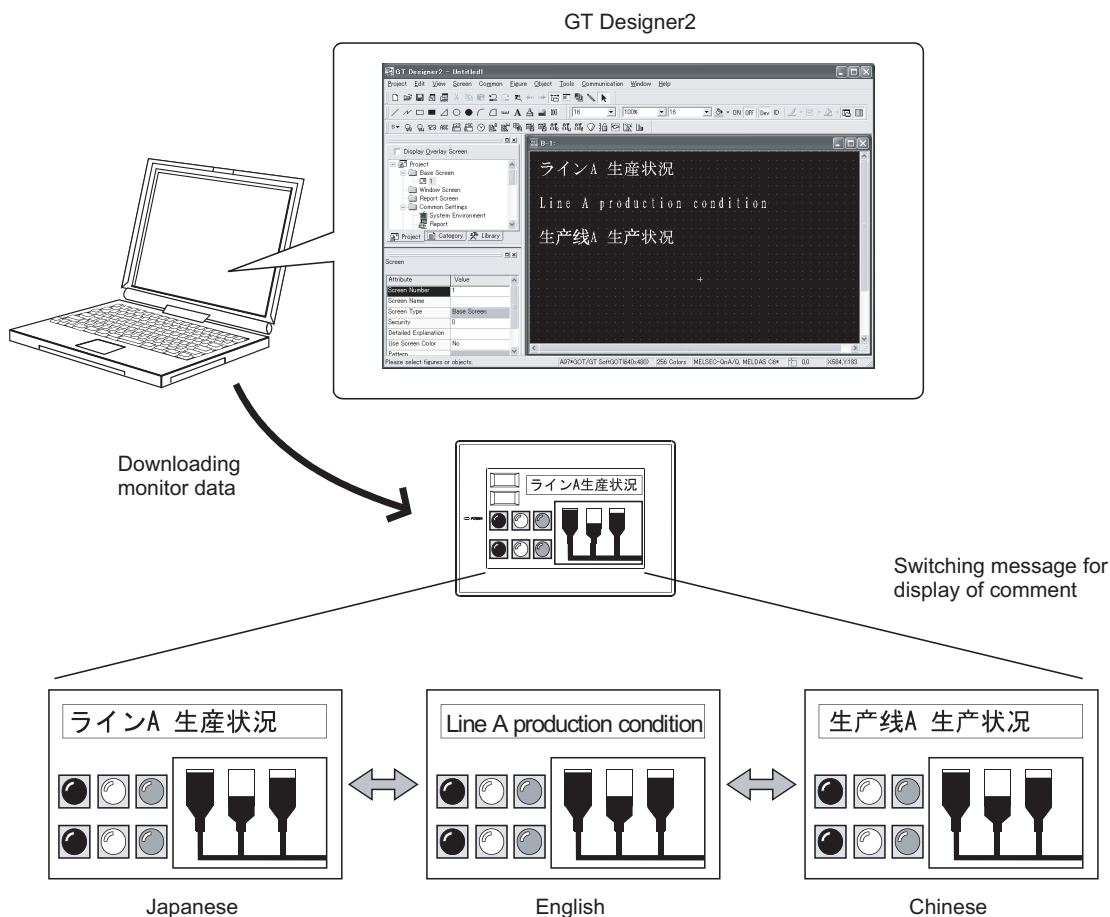


### Data check target

The targets of data check are only open screens. Unopened screens are not checked. To check all screens, open all screens and then start a data check.

## 9.4 Inputting multiple language

With multiple language function in Windows, various languages can be input on the GT Designer2. One GOT can display a screen for various languages by inputting letters and comments in various languages. \*1 (Language incompatible with Windows cannot be input.)



\*1: In the GOT-F900 Series, only one language (selected in "Character set") can be selected in one unit.

### Point

OS (Windows®) that allows input of multiple languages

Multiple language input is available for the OS (Windows®) below:

- Windows® 2000 Professional
- Windows® XP Professional
- Windows® XP Home Edition

## 9.4.1 Input method

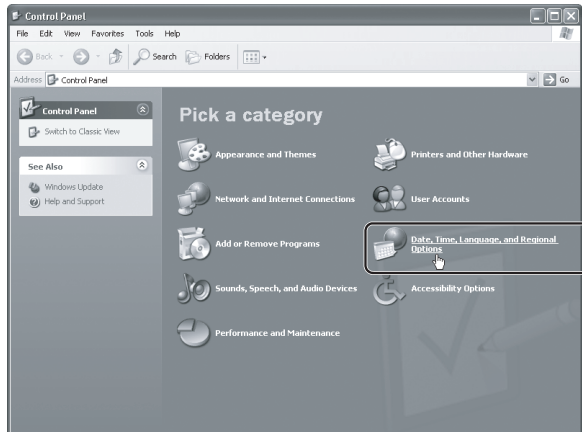
---

Procedures of inputting multiple languages are shown below:  
Refer to manual/help of Windows for detailed operation method of Windows®.

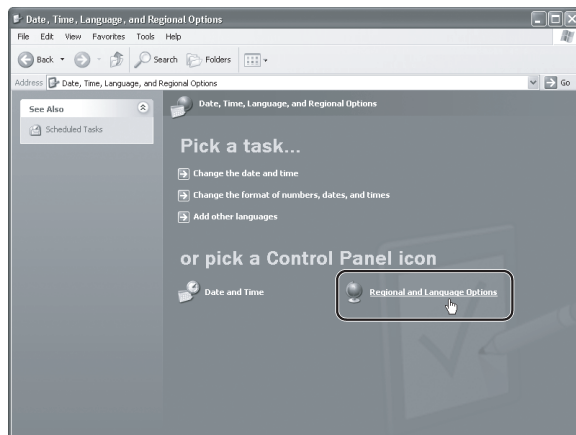
### 1 Setting for each Windows®

(1) For Windows® XP Professional, Windows® XP Home Edition

- 1 Choose the [Start] → [Control Panel] menu, and click [Date, Time, Language, and Regional Options].



- 2 Click "Regional and Language Options".

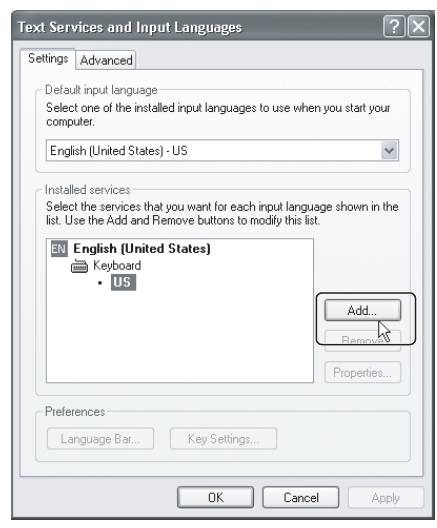


- As the [Regional and Language Options] dialog box appears, select the "Languages" tab, select the appropriate option in [Supplemental language support] and click the **Details...** button in [Text services and input languages].

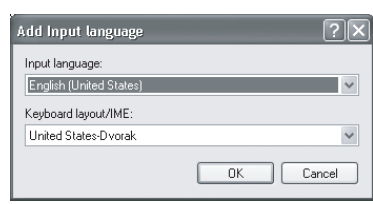


When adding Language for the first time, Windows®XP CD-ROM will be required.

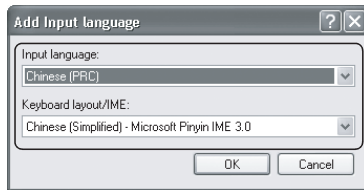
- As the [Text services and input languages] dialog box appears, click the **Add** button in [Supplemental language support].



- The [Add input language] dialog box appears.



- 6 Set the necessary language as Input language, and click the **OK** button.

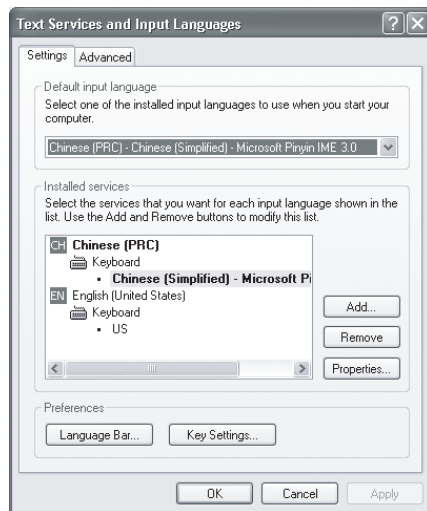


Setting example:

Input language : Chinese [PRC]

Keyboard layout/IME: Chinese(Simplified)-Microsoft Pinyin IME 3.0

Clicking the **OK** button will result in the following settings.

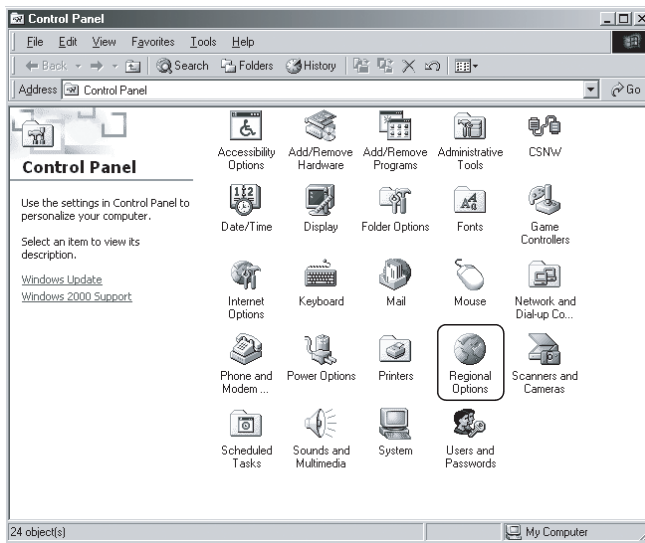


- 7 Click the **OK** button to apply the settings and close the dialog box.

At this time, the Windows® XP CD-ROM may be required depending on the added language.

(2) For Windows® 2000 professional

1 Choose the [Start] → [Control Panel] menu, and double-click [Regional Options].



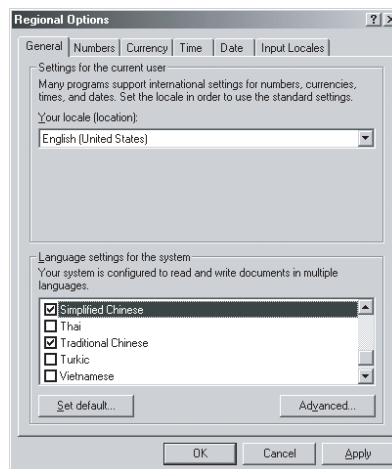
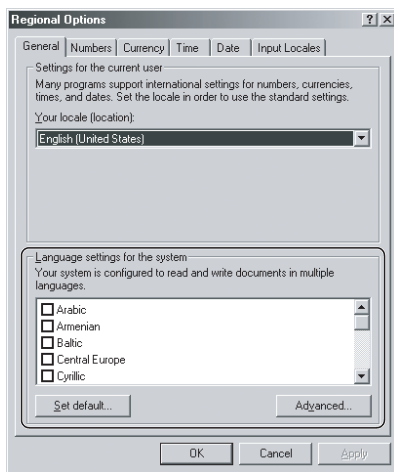
2 The [Regional Options] dialog box appears.

Set the language to be added in language settings for the system.

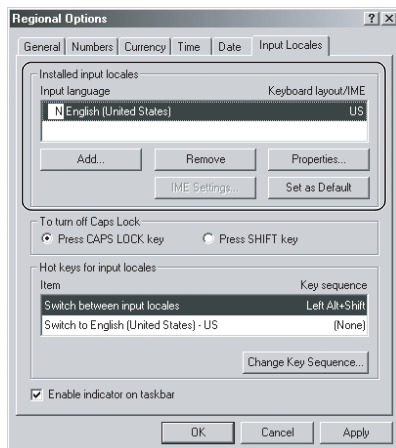
(Example)

When using Simplified Chinese

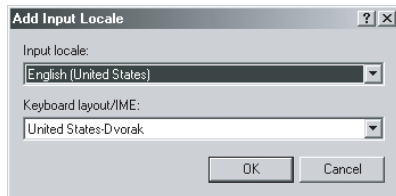
Check the Simplified Chinese check box.



- Click the Input Locales tab, and click the **Add** button in [Installed input locales].

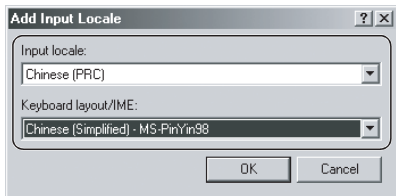


- The [Installed input locales] dialog box appears.



- Set the necessary language and click the **OK** button.

When the input language is set for the first time, the Windows® 2000 CD-ROM is required. To validate the added setting, make sure to restart Windows® 2000.

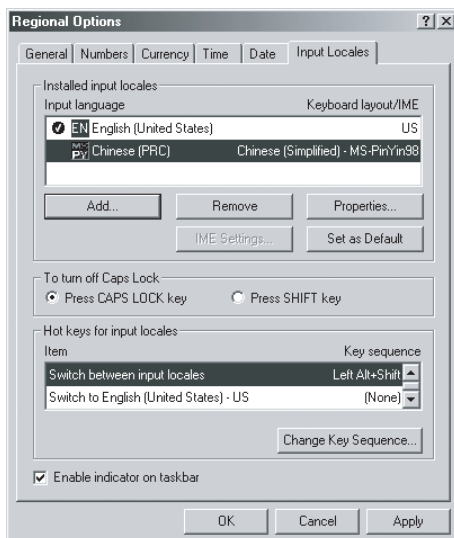


Setting example:

Input locale : Chinese [PRC]

Keyboard layout/IME: Chinese [Simplified]-QuanPin

Clicking the **OK** button will result in the following settings.



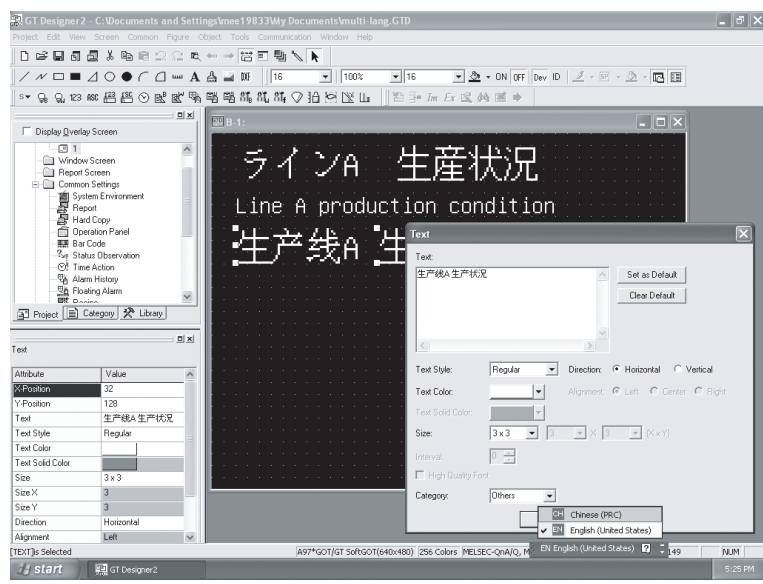


## 2 Input method

Click the language selection icon on the task bar at the bottom right of the screen to select the language to be input.

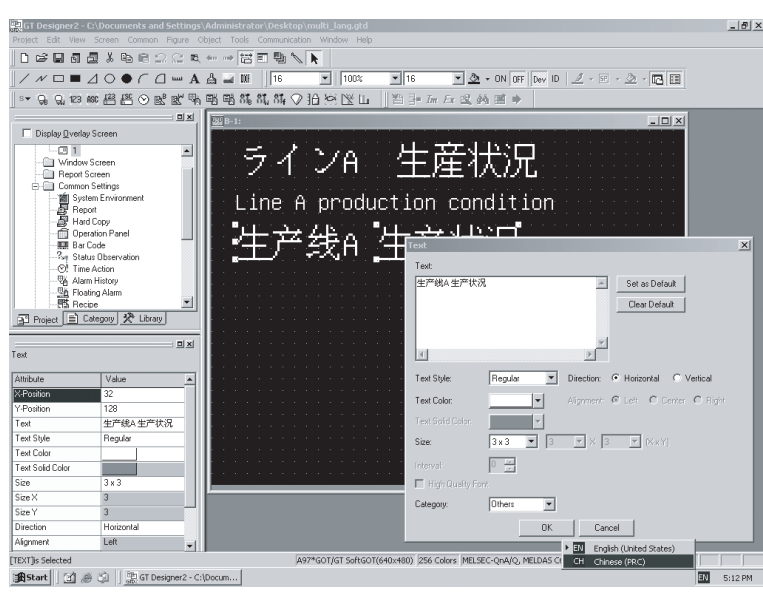
After selection, multiple languages can be entered on GT Designer2.

Example) Windows® XP Professional



- 1 Select a language to input.
- 2 Input comments or characters directly.

Example) Windows® 2000 Professional



- 1 Select a language to input.
- 2 Input comments or characters directly.

## 9.4.2 Precautions

---

### 1 Use of multiple language input system software (Chinese Writer, Korean Writer)

The Chinese Writer and the Korean Writer which were used on the GT Designer cannot be used on the GT Designer2. (Chinese Writer and Korean Writer are trademark of Kodensha.)

### 2 Precautions for printing

When "Output to file" is executed at the time of printing, only the language supported by the used OS (Windows®) as standard can be output.

### 3 Import/export of comments input in multiple languages

When comments input in multiple languages are imported/exported, use the Unicode text file format. If a normal text file or CSV file is used, the letters may be garbled. Refer to the manual below for import/export of comments:

 GT Designer2 Version□ Reference Manual

### 4 Drawing monitor data created in multiple languages on other OS (Windows) than Windows 2000 Professional/Windows XP Professional/Windows XP Home Edition

#### (1) Precautions for editing

Do not edit settings (comment or letter) that have the input language not supported by the OS (Windows). The characters may be garbled.

#### (2) Display on workspace, property sheet and dialog

Multiple languages on the workspace, property sheet and dialog are garbled. If the display on the GT Designer2 is correct, it is correctly displayed on the GOT.

### 5 When using the GOT-F900 Series

#### (1) Two or more languages cannot be displayed.

In the GOT-F900, only one language selected in "Character Set" can be displayed on all screens. It is impossible to display two or more languages on one screen or to display a different language on a different screen.

If an unselected language is displayed, irregular characters are displayed.

#### (2) Cautions on fonts built in the GOT

Built-in fonts (languages) vary depending on the GOT-F900 model. Select a model supporting the language to be used.

Example: When Chinese is to be displayed in the F930GOT  
Select the F930GOT-BWD-C.

For the details of built-in fonts, refer to the GOT-F900 SERIES HARDWARE MANUAL [COMMON CONNECTION] or the GOT-F900 SERIES OPERATION MANUAL [GT Designer2].

## 9.5 Confirming the created data size

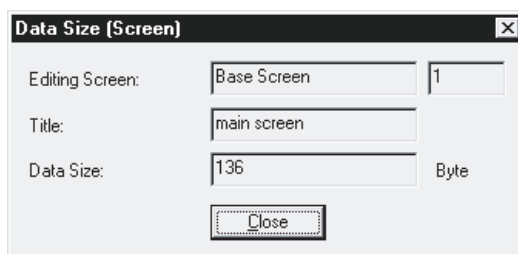
Before transferring the monitor data created using GT Designer2 to the GOT, data size can be confirmed for each screen or project.

### 9.5.1 Confirmation method

- 1 Select [Tool] → [Data Size] → [Screen]/[Project] menu.
- 2 The data size dialog box appears. Confirm the data size.

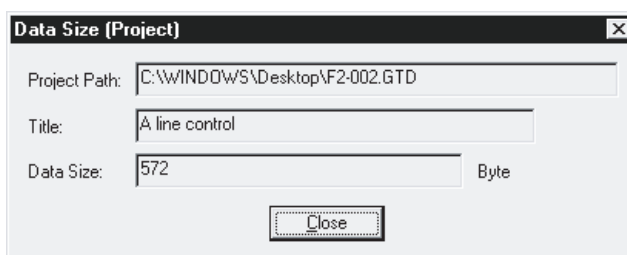
### 9.5.2 Confirmation items

#### 1 Screen



Item	Description	A	F
Editing Screen	The editing screen type and screen No. are displayed	<input type="radio"/>	<input type="radio"/>
Title	The screen title is displayed.	<input type="radio"/>	<input type="radio"/>
Data Size	The screen data size is displayed.	<input type="radio"/>	<input type="radio"/>

#### 2 Project



Item	Description	A	F
Project Path	The path for the editing project is displayed.	<input type="radio"/>	<input type="radio"/>
Title	The project title is displayed.	<input type="radio"/>	<input type="radio"/>
Data Size	The project data size is displayed.	<input type="radio"/>	<input type="radio"/>

## 9.6 Utilizing other project data

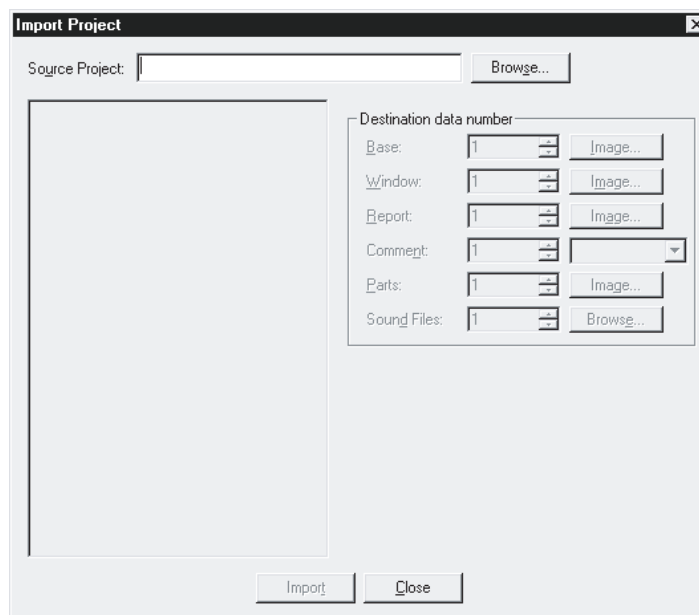
It is possible to utilize other project data, i.e., import other project data (Source project) into the currently edited project (Destination data).

This function is effective when utilizing multiple project data.

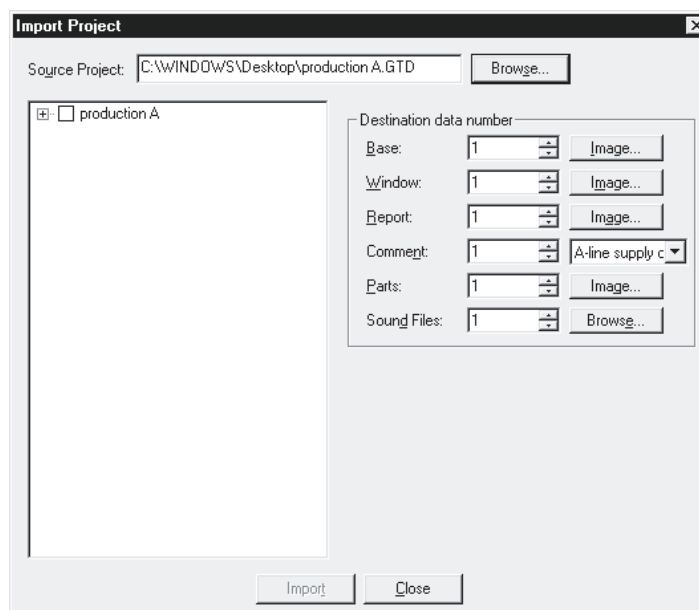
It supports GT Designer data as well.

### 9.6.1 Importing data

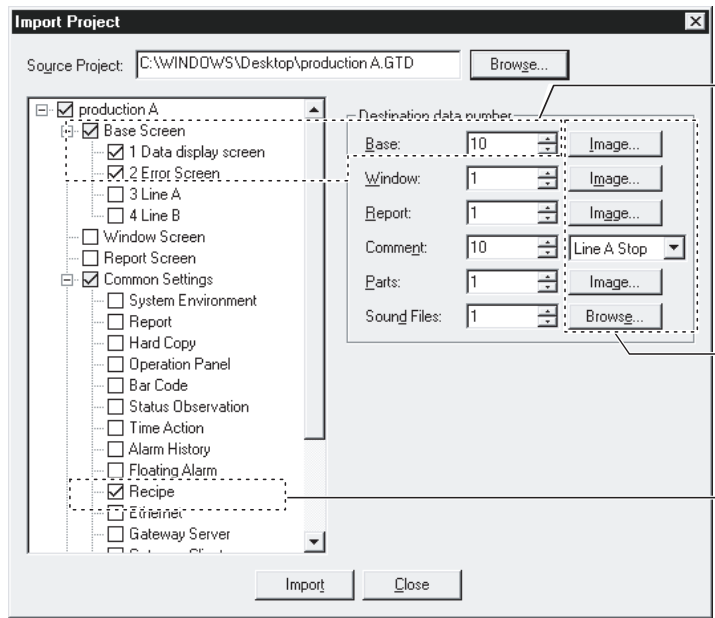
- 1 Select [Project] – [Import Project] from the menu.
- 2 The Import Project dialog box appears.



- 3 Click the **Browse** button and select a project to be imported, i.e., source project (or directly enter the path). After the selection, the project data is displayed in tree format.



- 4 When selecting screen, parts or sound data for utilization, set it the No. to be used in the destination project. (When selecting multiple data, set the head No.)  
 If the data of the same No. already exists in the destination project, the existing data will be deleted, i.e., overwritten. (Use the **Image** or **Browse** button to check the data in the destination project.)  
 All common settings will be overwritten.



The base screen No.1 and No.2 are imported into the destination project as the base screen No.10 and No.11, respectively. If the base screen No.10 and No.11 already exist in the destination project, these existing screen data will be deleted, i.e., overwritten.

Use the **Image** or **Browse** button to check the data in the destination project. With this operation, the preset comment can be also checked.

The recipe function setting is written over the corresponding settings within the destination project.

- 5 Click the **Import** button to import the selected data.
- 6 After the data import is completed, confirm the imported data and the relevant settings.

### 9.6.2 Cautions

- 1 If the GOT type or PLC type set for the source project differs from that for the destination project.
  - (1) If the GOT type set for the source project differs from that for the destination project, the GOT type of the imported data is changed to the one set for the destination project.  
 With this import, some functions may be deleted due to the GOT type incompatibility.
  - (2) If the PLC type set for the source project differs from that for the destination project, the PLC type of the imported data is changed to the one set for the destination project.  
 GT Desginer2 may delete some devices, as the device type is incompatible or they are out of the applicable setting range.  
 Make the device settings as necessary.




### Hold the incompatible devices

The incompatible devices, i.e., devices to be deleted after the data import (described in (2) above), can be held by executing the following.

- ① Change the PLC type set for the source project to the one for the destination project.
- ② Check for the objects converted to "??" in the device list. (The incompatible devices are converted to "??".)
- ③ Make the settings of the devices for the objects converted to "??".
- ④ Save the modified source project. Then, open the destination project, and execute the series of operations for [Import project], i.e., utilizing other project data.

## 2 Incompatible data

- (1) The GT Designer2 cannot import the data of functions, if the functions are unsupported by the GOT type of the destination project.
- (2) If the monitor data is imported using the GT Designer2 version that is older than the one used to create the source project, some functions or settings may be deleted.  
To import the relevant data, make sure to use the GT Designer2 version that is the same or newer than the one used to create the source project.  
For the compatibility between monitor data and GT Designer2 version, refer to the following.  
 Appendix 4 Applicable Monitor Data
- (3) The GT Designer2 cannot import the data of the following common settings.  
Therefore, make the settings again in the destination project.
  - [System Settings] and [Project Title] within [System Environment]
  - [Script]



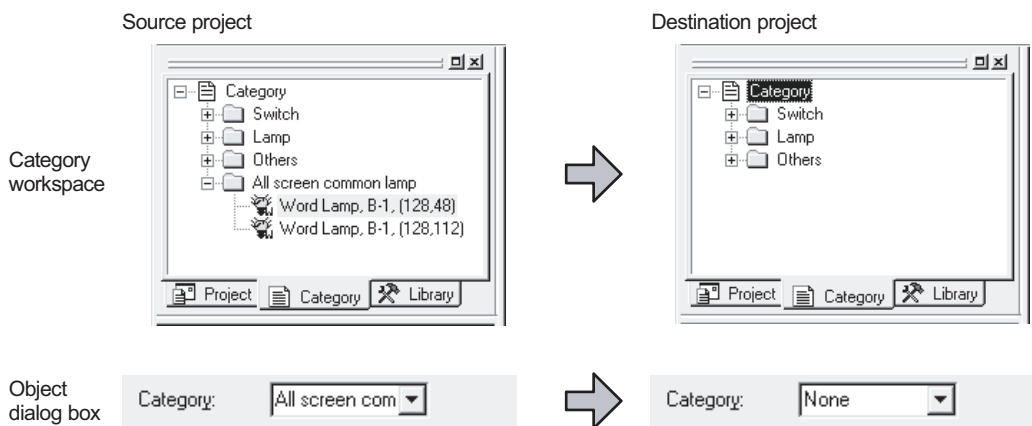
### Make the settings again

Start two GT Designer2 windows. Open the source project on the one window, and the destination project on the other window, and make the settings by comparing the two project settings.

- (4) When the object data is imported to the project in which the corresponding category is not set, the object will be registered within the [None] category, even if the category has been set in the source project.

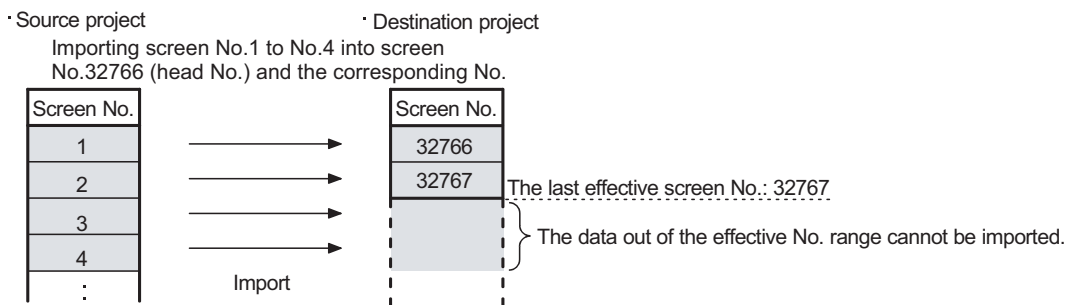
To set the category, create the same category within the destination project, in advance or after the data import.

(Example) When the data in the "All Screen Common Lamp" category is imported.



- (5) When a data import is executed based on the setting so that the data No. to be assigned will exceed the effective No. range, the data out of the No. range cannot be imported.

(Example) When importing base screen data



- (6) When the [System Environment] setting window is opened on the destination project, [System Environment] cannot be selected. (Not displayed in the tree structure.) When importing the [System environment] setting, close the [System Environment] setting window on the destination project, and then select the project to be imported.























# APPENDIX






## Appendix 1 List of Shortcut Keys

### 1 List of shortcut keys for menu

Item		Shortcut keys	A	F
[Project (P)]	 New Screen (N)	Ctrl+N	<input type="radio"/>	<input type="radio"/>
	 Open (O)...	Ctrl+O	<input type="radio"/>	<input type="radio"/>
	 Save (S)	Ctrl+S	<input type="radio"/>	<input type="radio"/>
	 Print (P)...	Ctrl+P	<input type="radio"/>	<input type="radio"/>
	Exit (X)	Alt+F4	<input type="radio"/>	<input type="radio"/>
[Edit (E)]	 Undo (U)	Ctrl+Z	<input type="radio"/>	<input type="radio"/>
	 Redo (R)	Ctrl+Y	<input type="radio"/>	<input type="radio"/>
	 Cut (I)	Ctrl+X	<input type="radio"/>	<input type="radio"/>
	 Copy (C)	Ctrl+C	<input type="radio"/>	<input type="radio"/>
	 Paste (S)	Ctrl+V	<input type="radio"/>	<input type="radio"/>
	Delete (D)	DEL	<input type="radio"/>	<input type="radio"/>
	Select All (S)	Ctrl+A	<input type="radio"/>	<input type="radio"/>
	 Group (G)	Ctrl+G	<input type="radio"/>	<input type="radio"/>
	 Ungroup (N)	Ctrl+U	<input type="radio"/>	<input type="radio"/>
	 Flip Vertical (V)	Ctrl+J	<input type="radio"/>	<input checked="" type="radio"/>
	 Flip Horizontal (H)	Ctrl+H	<input type="radio"/>	<input checked="" type="radio"/>
	 Rotate Left (L)	Ctrl+L	<input type="radio"/>	<input checked="" type="radio"/>
	 Rotate Right (R)	Ctrl+R	<input type="radio"/>	<input checked="" type="radio"/>
	 Bring to Front (B)	Ctrl+F	<input type="radio"/>	<input type="radio"/>
	 Send to Back (K)	Ctrl+B	<input type="radio"/>	<input type="radio"/>
	Attribute (E)...	Alt+Enter	<input type="radio"/>	<input type="radio"/>
[View (V)]	 Preview (P)	Ctrl+I	<input type="radio"/>	<input type="radio"/>
	 Workspace (W)	Alt+0	<input type="radio"/>	<input type="radio"/>
	 Property sheet (E)	Alt+1	<input type="radio"/>	<input type="radio"/>
	Redisplay	F5	<input type="radio"/>	<input type="radio"/>
	 Zoom	Ctrl+Wheel	<input type="radio"/>	<input type="radio"/>
[Screen (S)]	Close (C)	Ctrl+W	<input type="radio"/>	<input type="radio"/>

## 2 List of shortcut keys for comment creating/editing operation

(Valid for Comment list window only)

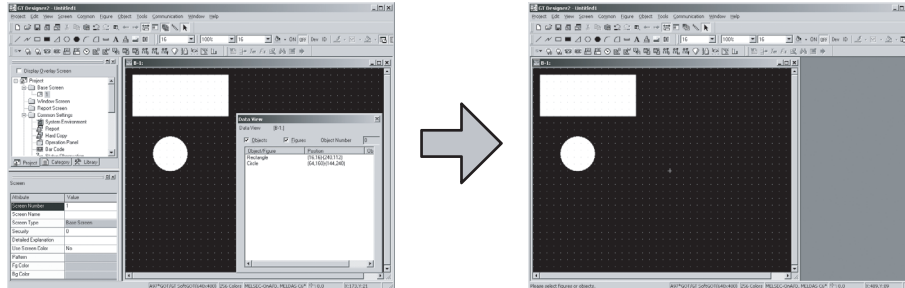
	Item	Shortcut key
[Comment creating/ editing operation]	 New	Alt+N
	 Copy	Ctrl+C
	 Paste	Ctrl+V
	Delete	DEL
	Line feed	Alt+Enter
	Edit	F2
	 Import...	Alt+I
	 Export...	Alt+X
	Mouse click *1	Space *1

\*1: When the cursor is located in the cell position of the comment No. comment, text color or high-quality font, pressing Space provides the same operation as performed by a mouse click.  
Using the Space key together with the Tab key that moves the cursor in the horizontal direction of the cell enables convenient keyboard operation.

# Appendix 2 Q&A of GT Designer2 Operation

Q&A for GT Designer2 operation is described below:

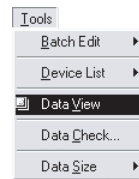
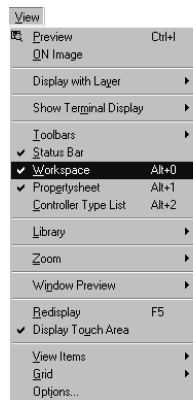
**Q1. The workspace/property sheet/data view has disappeared from the screen. How can it be displayed?**



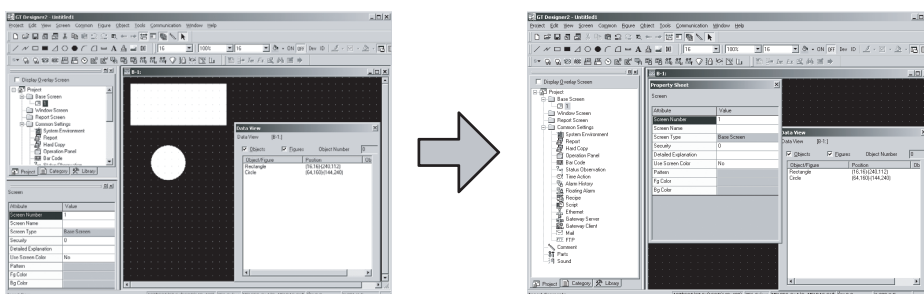
A1. Select [View] → [Workspace/property sheet] to display the workspace and the property sheet.  
Select [Tools] → [Data View] to display the data view.


For Workspace/property sheet

For Data View

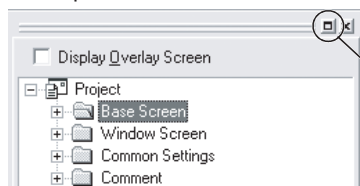


**Q2. I don't know how to pop up the property sheet or the data view.**

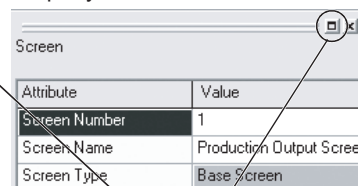


A2. Click  at the upper right to pop up the workspace/property sheet or the data view.

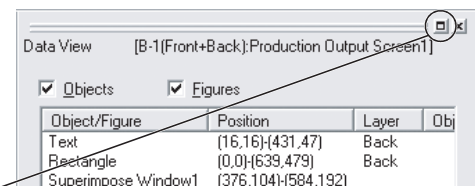
Workspace



Property Sheet

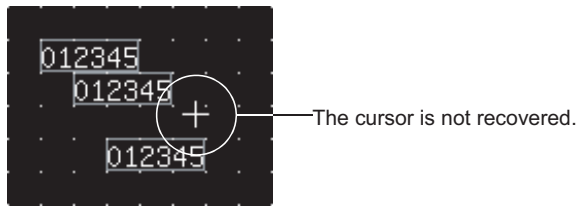


Data View

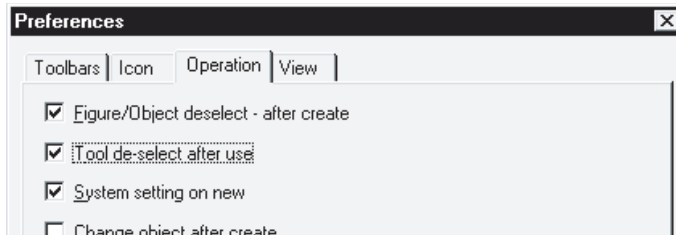


Click here.

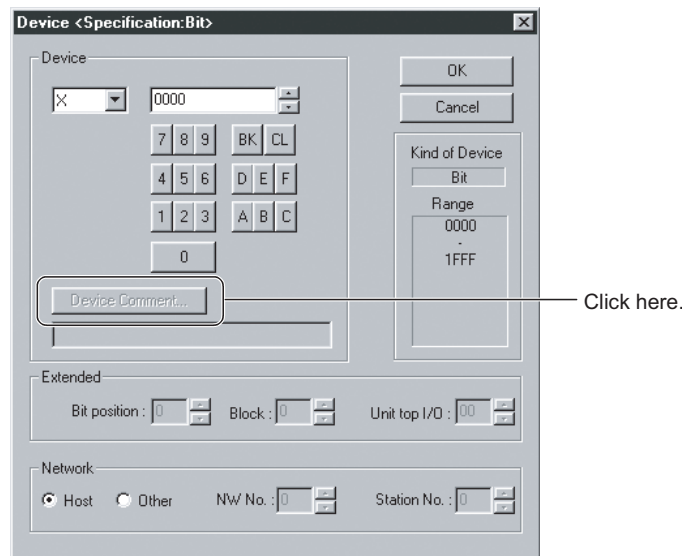
Q3. The cursor remains to be + mark. Objects are continuously arranged. How can the cursor be recovered?



A3. After arrangement of an object, right click the mouse or press the **[Esc]** key on the keyboard to recover the cursor to . To maintain the cursor to an arrow mark, select [Project] → [Preferences] and check "Tool de-select after use" on the operation tab.



Q4. The device comment cannot be selected in device setting.

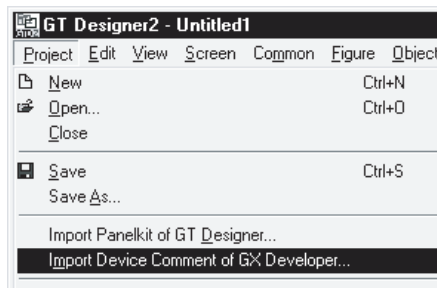


A4. To select the device comment, the comment data of the GX Developer needs to be imported into the GT Designer2.

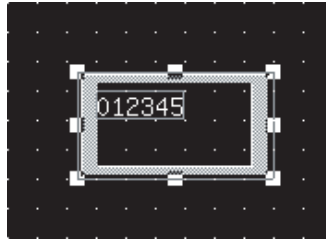
Before setting the device, select [Project] → [Import Device Comment of GX Developer] and select the project of the GX Developer to be imported.

Refer to the following for the device comment reference of the GX Developer.

Section 9.2 Referring to Device Comment When Setting Devices



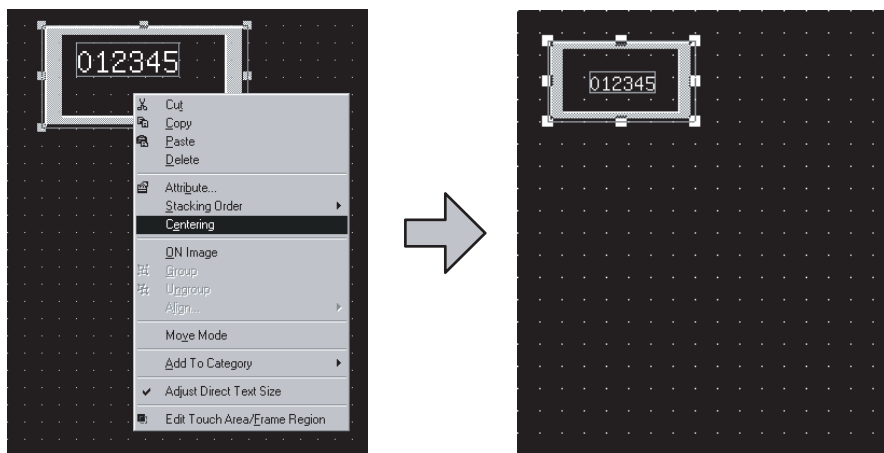
Q5. Object figure is not accurately arranged.



A5. Right click the mouse on the object and select [Edit Touch Area/Frame Region] and [Centering]. The object is then accurately arranged.

When Centering is selected, the object is automatically moved to the center of the figure.

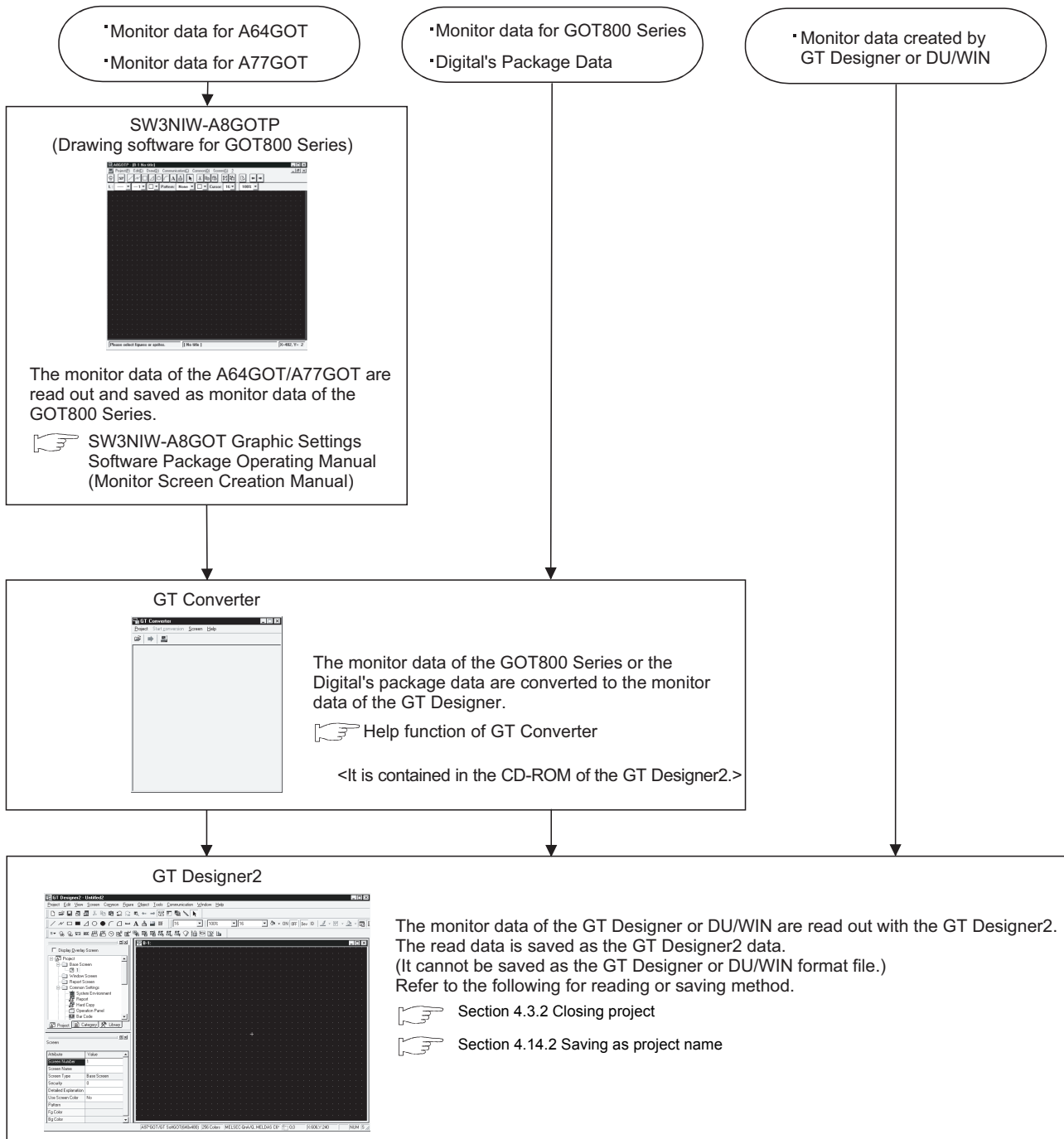
When Edit Touch Area/Frame Region is selected, the object and the figure are independently moved, enlarged or reduced. The arrangement position of the object and the figure can be finely adjusted. (When the touch switch is set, the valid area of the touch switch can be set.)



# Appendix 3 Using Existing Data

## Appendix 3.1 Outline procedures

The outline procedures for converting the existing data to the GT Designer2 data are shown below.



### Remark

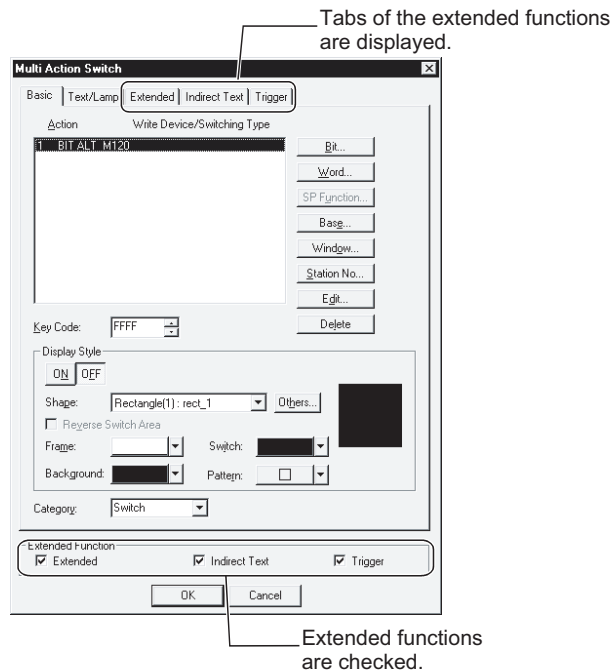
When converting the Du/wim file to the GT11 data.

- (1) Start the GT Designer2 with GT11.
- (2) Import project data with [Import Project...] of the GT Designer 2.  
Refer to project Data Conversion Summary for details of the project data conversion.

### 1 Using the GT Designer monitor data

- (1) The object setting dialog box is displayed with all extended functions selected.

Ex.) When setting the touch switch



- (2) Switch-grouped objects on the GT Designer are treated as normally grouped objects on the GT Designer2.
- (3) "Category" shows "none" (Category none).



#### Opening monitor screen data with GT Designer2


The monitor screen data which are opened with the GT Designer2 cannot be saved as a GT Designer format file.

### 2 Using monitor data of GOT800 Series

Action of the GOT800 Series may be different from that of the GOT900 Series for some functions. Use of the GOT800 compatible mode can change the functions with different actions to actions of the GOT800 Series.

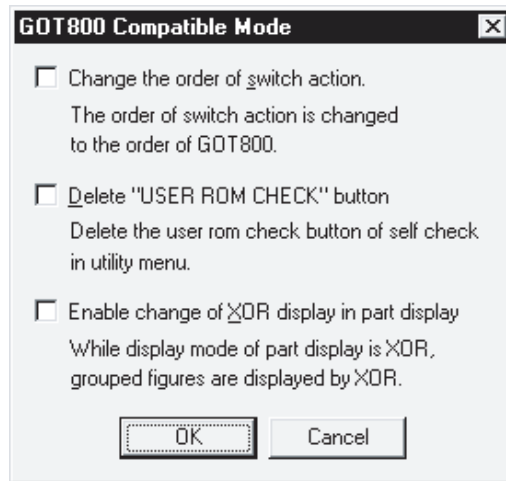
 This section: (1) GOT800 compatible mode

For functions that have no compatibility with the GOT800 compatible mode, a user should change the sequence program or the monitor data.

 This section: (2) Different actions of functions between GOT800 Series and GOT900 Series, and corrective actions

(1) GOT800 compatible mode

- ① Select the [Common] → [GOT800 Compatible Mode] from the menu.
- ② The setting dialog box appears. Refer to the following descriptions for setting.



Item	Description	A	F
Change the order of switch action	Priority of duplicate setting for the touch switch is changed to priority of the GOT800 Series.	○	×
Delete USER ROM CHECK button	The user check area of the GOT (utility self-diagnosis) is deleted.	○	×
Enable change of XOR display in part display	When the XOR display is set in display mode of the part display function, grouped figures are XORed at a time and displayed.	○	×

**Remark**

[Delete "USER ROM CHECK" button]

When the user area is checked on the GOT, the monitor data in the GOT is deleted. Deletion of the user area check can prevent deletion of the monitor data by incorrect operation by a user.



(2) Different actions of functions between GOT800 Series and GOT900 Series, and corrective actions

Item	Description	Procedures to replace the GOT800 Series with the GOT-A900 Series																							
Part Display	<p>When you have selected [Display mode] - [XOR display], the parts that group overlapping figures are displayed as follows:            GOT800 Series: All grouped figures are displayed at once, when using XOR-display.            GOT-A900 Series: Each in the grouped figures is displayed one at a time in the overlapping order, when using XOR-display.</p>	<p>With the GOT800 Compatible mode, no action is required.</p>																							
	<p>When you create data by setting the same line color and pattern color with pattern type 8 (fill) after selecting [Display mode] - [XOR display] in the GOT800 Series and then convert it into the GOT-A900 Series, the outside of that data part is displayed one dot smaller.</p>																								
	<p>When you create data by selecting [Display mode] - [XOR display] in the GOT800 Series (16-color models) and then display it with the GOT-A900 Series (16-color models), the overlapped data area is displayed dark. (For that data, the display colors are matched with those of a 256-color model in the GOT-A900 Series.)</p> <p>&lt;Example&gt;</p> <table border="0" data-bbox="354 987 906 1173"> <tr> <td>GOT used</td> <td>Color of figure</td> <td>Color of part</td> <td>Color of overlapped areas</td> </tr> <tr> <td>GOT800 (16 colors)</td> <td>Blue</td> <td>White</td> <td>Yellow</td> </tr> <tr> <td>GOT-A900 (16 colors)</td> <td>Blue</td> <td>White</td> <td>Dark yellow</td> </tr> <tr> <td>GOT-A900 (256 colors)</td> <td>Blue</td> <td>White</td> <td>Yellow</td> </tr> </table>	GOT used	Color of figure	Color of part	Color of overlapped areas	GOT800 (16 colors)	Blue	White	Yellow	GOT-A900 (16 colors)	Blue	White	Dark yellow	GOT-A900 (256 colors)	Blue	White	Yellow	<p>It is not always necessary to change the settings of the colors. You can lighten the dark overlapped area by setting the product's color darker. (Either the color of a part or an overlapped area will always have a dark color.)</p> <p>&lt;In the case of the example at left&gt;</p> <table border="0" data-bbox="919 987 1474 1111"> <tr> <td>GOT used</td> <td>Color of figure</td> <td>Color of part</td> <td>Color of overlapped areas</td> </tr> <tr> <td>GOT900 (16 colors)</td> <td>Blue</td> <td>Dark white</td> <td>Yellow</td> </tr> </table>	GOT used	Color of figure	Color of part	Color of overlapped areas	GOT900 (16 colors)	Blue	Dark white
GOT used	Color of figure	Color of part	Color of overlapped areas																						
GOT800 (16 colors)	Blue	White	Yellow																						
GOT-A900 (16 colors)	Blue	White	Dark yellow																						
GOT-A900 (256 colors)	Blue	White	Yellow																						
GOT used	Color of figure	Color of part	Color of overlapped areas																						
GOT900 (16 colors)	Blue	Dark white	Yellow																						
Part Movement	<p>If the device value becomes a negative numeric value or out of the display range, the data created by setting [Indirect] for [Parts indication] using the "Part movement" function of the GOT800 Series is displayed as follows:            GOT800 Series: Parts are not displayed.            GOT-A900 Series: Parts are displayed.</p>	<p>No problem will occur unless you have set [Indirect] using the "Part movement" function.            In addition, there is no problem to set [Indirect] unless the device value becomes a negative numeric value or out of the [Display range].            If the device value becomes a negative numeric value or out of the [Display range] range, set the part number to "0" and out of the [Display range].            (Setting the [Display part] number to "0" hides parts.)</p>																							
Touch Switch	<p>The priority varies depending on the GOT when duplicate touch keys have been set.            GOT800 Series: Word SET → Bit SET            GOT-A900 Series: Bit SET → Word SET</p>	<p>With the GOT800 Compatible mode, no action is required.</p>																							

(Continued to next page)

Item	Description	Procedures to replace the GOT800 Series with the GOT-A900 Series
System information [Before/after change]	<p>The values of system information before and after changes vary depending on the GOT, when you enter a negative value via 16-bit signed BIN numeric value input.</p> <p>Example: Value before numeric value input: -1 Value for numeric value input: -2</p> <p>&lt;System information of the GOT800 Series&gt; Value before change : 0X0000FFFF Value after change : 0X0000FFFE</p> <p>&lt;System information of the GOT-A900 Series&gt; Value before change : 0XFFFFFFF Value after change : 0XFFFFFFFE</p>	<p>No problem will occur unless you enter a negative value via 16-bit signed BIN numeric value input.</p> <p>In addition, there is no problem if the GOT references sequence programs using a negative value before changing the system information as 16 bits.</p> <p>When the GOT references sequence program using the value before changing the system information as 32 bits, extract the lower 16 bits and then reference.</p>
System information [Automatic Screen Saver Disable Signal (b0), Forced Screen Saver Enable Signal (b1)]	<p>In the GOT-A900 Series, the operation of b1 (forced screen saver enable signal) takes precedence of the operation of b0 (automatic screen saver disable signal).</p> <p>This may cause some GOTs to work differently if both b0 and b1 are turned on.</p> <p>&lt;If both b0 and b1 are turned on&gt;</p> <p>GOT800 Series: The display and backlight are both turned off by the screen saver.</p> <p>GOT-A900 Series: The display and backlight both remain on.</p>	<p>You should change the sequence programs, etc. if the forced screen saver enable signal (b1) and the automatic screen saver disable signal (b0) turn on/off the backlight.</p>

### 3 When diverting the monitor data of the DU/WIN

- (1) Only screen data files of the GOT-F900 Series can be read.
- (2) Some functions are equivalent to those on the dialog box of the DU/WIN.  
For the details, refer to the GOT-F900 SERIES OPERATION MANUAL (GT Designer2).
- (3) Touch key with screen switching function  
The touch key with screen switching function is converted to the multi action switch with the base screen switching function.
- (4) Lamp  
The color for the outer frame on the lamp remains.

# Appendix 4 Applicable Monitor Data

This section provides the precautions for using monitor data.  
Pay attention to the precautions outlined in this section when handling monitor data.

## 1 When opening/uploading monitor data

When opening or uploading monitor data, make sure to use the same or newer version of GT Designer2 than the one used to create the monitor data.  
When the older version is used, the file may not be opened or the functions and settings may be deleted.

Refer to the following section for details.

☞ Appendix 4.1 Opening monitor data

or

☞ Appendix 4.2 Uploading monitor data



## 2 When downloading/copying monitor data to the GOT

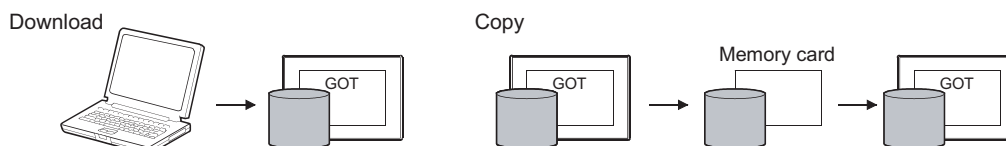
Make sure to install the same OS version as the copy/download source monitor data.  
If the OS version of GT Designer2 used to create the monitor data does not match the OS version installed in the GOT, download the monitor data after installation of the OS.

Refer to the following section for details.

☞ Appendix 4.3 Downloading monitor data

or

☞ Appendix 4.4 Copying monitor data from one GOT unit to other unit with a PC card



The following shows the points to be check by the subject when using monitor data.

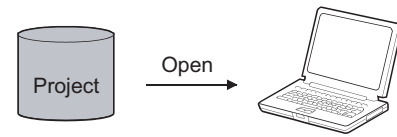
This section provides the cautions on the software version compatibility only.  
When using functions depending on the GOT ROM\_BIOS, the corresponding ROM\_BIOS version must be installed in the GOT.  
For ROM\_BIOS-dependant functions, refer to the following.

☞ Section 5.1.1 **1** ROM\_BIOS

## Appendix 4.1 Opening monitor data

### 1 POINT

The target monitor data can be opened using the same or newer version of GT Designer2 than the one used to create the target monitor data.



GT Designer2 version used to create project data  $\leq$  GT Designer2 version used to open

### 2 Precautions

When the monitor data is opened with the same or older software version than the one used to create it, some functions/settings are invalid due to version incompatibility.

The following table shows the compatibility between the software versions.

Software used to open monitor data		Software used to create monitor data		
		GT Designer2	GT Designer	
		Version1	Version5.13P or later	Version1.00A to Version5.10L
GT Designer2	Version1	●	●	●
GT Designer	Version5.13P or later	-	▲	▲
	Version1.00A to Version5.10L	-	△	△

● : Compatible.

▲ : When opening the monitor data by older version software, some functions/settings are invalid. (Warning message will appear when the data is opened.)

△ : When opening the monitor data by older version software, some functions/settings are invalid and also data is corrupted.

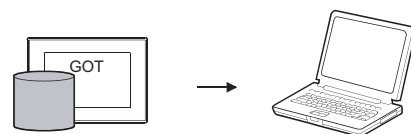
(Warning message will not appear when the data is opened.)

- : GT Designer cannot open the GT Designer2 format files.

## Appendix 4.2 Uploading monitor data

### 1 POINT

When uploading monitor data from the GOT, make sure use the same or newer version of GT Designer2 than the one used to download the monitor data.



GT Designer2 version used to download  $\leq$  GT Designer2 version used to upload

## 2 Precautions

When the monitor data is uploaded with the same or older software version than the one used to download it, some functions/settings are invalid due to version incompatibility.

The following table shows the compatibility between the software versions.

Software used to upload monitor data		Software used to download monitor data		
		GT Designer2	GT Designer	
		Version1	Version5.13P or later	Version1.00A to Version5.10L
GT Designer2	Version1	●	●	●
GT Designer	Version5.13P or later	▲ *1	▲ *2	●
	Version1.00A to Version5.10L	△	△	△

● : Compatible.

▲ : When uploading the monitor data by older version software, some functions/settings are invalid.

\*1: Warning message will appear regardless of whether the data includes the settings of unsupported functions.

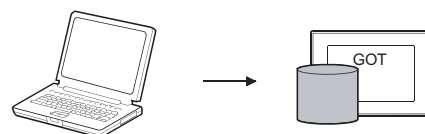
\*2: Warning message will appear only when the data includes the settings of unsupported functions.

△ : When opening the monitor data by older version software, some functions/settings are invalid, and also the data is corrupted. (Warning message will not appear when the data is opened.)

## Appendix 4.3 Downloading monitor data

### 1 POINT

Make sure to download the monitor data after installing the same OS version as GT Designer2 into the GOT.



OS version of GT Designer2 used to download      OS version installed in GOT

### 2 Precautions

When the monitor data is downloaded using the software with the same or newer OS version installed in the GOT, some functions/settings are invalid due to OS incompatibility.

### 3 Solution

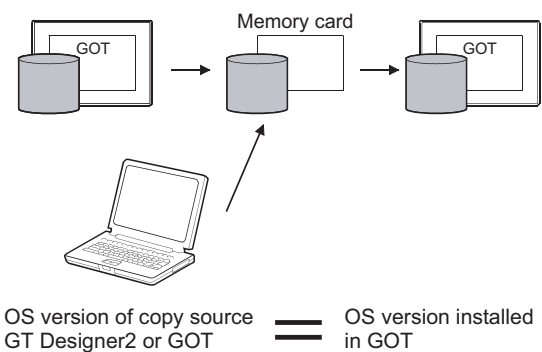
It is recommended to reinstall the latest OS. (The OS version installed in GOT can be checked within the utility (internal memory information.)

## Appendix 4.4 Copying monitor data from one GOT unit to other unit with a PC card

---

### 1 POINT

When writing monitor data to a memory card, make sure to write the OS as well. Also, when downloading the monitor data, make sure to install the OS to the GOT.



### 2 Precautions

If the OS version in the target GOT is the same or older than the one in the source GOT, some functions/settings are invalid due to OS incompatibility

### 3 Solution

It is recommended to copy OS with monitor data into PC card, and copy them into the target GOT. (The OS version installed in GOT can be checked within the utility (internal memory information).)



# INDEX

[A]	Aligning figures and objects . . . . .	8-22	[L]	Library	
[B]	Basic operation of dialog box . . . . .	3-2		Changing library property . . . . .	7-13
[C]	Category workspace . . . . .	9-5		Copying registered library/template. . . . .	7-9
	Changing attributes of figure and object. . . . .	8-28		Creating Original library . . . . .	7-7
	Changing size of figure and object . . . . .	8-30		Deleting registered library/template. . . . .	7-10
	Copying figure and object continuously . . . . .	8-32		Editing registered objects and figures . . . . .	7-11
	Customizing			Loading library from file . . . . .	7-17
	Customizing GT Designer2 operating environment			Pasting object or figures from library. . . . .	7-6
	. . . . .	3-26		Registering objects or figures to library. . . . .	7-7
	Customizing screen configuration. . . . .	3-20		Saving library . . . . .	7-14
	Customizing toolbars. . . . .	3-22	[M]	Memory space required for data transfer . . . . .	5-8
[D]	Data check . . . . .	4-54		Menu configuration . . . . .	3-8
	Data size. . . . .	9-34	[O]	Operating environment . . . . .	2-1
	Data transfer operation. . . . .	5-1		Operation of workspace . . . . .	3-4
	Data type to be installed on GOT . . . . .	5-1	[P]	Painting figure . . . . .	8-8
	Data view . . . . .	9-16		Pasting figure data of BMP file . . . . .	8-10,8-13
	Device list . . . . .	9-17		Pasting figure data of DXF file . . . . .	8-10
	Display with frame . . . . .	3-32		Printing . . . . .	6-1
	Downloading monitor data . . . . .	5-26		Project	
	Downloading special data. . . . .	5-28		Closing . . . . .	4-11
	Drawing figures. . . . .	8-1		Creating a new project . . . . .	4-3
[E]	Editing figure and objects . . . . .	8-20		Opening. . . . .	4-9
	Ending GT Designer2. . . . .	4-58		Overwriting and saving . . . . .	4-56
	Entering text . . . . .	8-6		Providing title. . . . .	4-12
	Error message for data transfer . . . . .	5-37		Saving as . . . . .	4-56
[F]	File output. . . . .	6-1		Property sheet . . . . .	9-1
[G]	Getting built-in memory information . . . . .	5-19	[R]	Redo . . . . .	8-18
	Grouping/ungrouping . . . . .	8-21		Referring to device comment . . . . .	9-21
[H]	How to use Help . . . . .	3-34		Repeating . . . . .	8-18
[I]	Inputting multiple language. . . . .	9-26		RS-232 cable to be used . . . . .	2-5
	Installing OS . . . . .	5-24	[S]	Screen	
	Installing ROM_BIOS . . . . .	5-21,5-31		Cascading/tiling screens . . . . .	4-38
				Changing property. . . . .	4-40
				Closing . . . . .	4-21
				Copying screen data . . . . .	4-47
				Creating a new screen . . . . .	4-13
				Deleting screen data . . . . .	4-50
				Making editing screen active . . . . .	4-39
				Opening. . . . .	4-17
				Operating multiple screens . . . . .	4-38
				Viewing screen image. . . . .	4-43
				Screen configuration. . . . .	3-1



Selecting figure and object . . . . .	8-18
Setting communication . . . . .	5-18
Setting screen switching device . . . . .	4-52
Short cut list. . . . .	App-1
System configuration	
System configuration in creating monitor screen . . . . .	2-1
System configuration of data transfer and document creation . . . . .	2-1
[T]	
Transferring data using PC card . . . . .	5-29
Transferring data with RS-232C cable . . . . .	5-13
Transferring OS, monitor data and special data . . . . .	5-34
Type and size of transfer data to GOT . . . . .	5-1
Types of toolbars . . . . .	3-11
[U]	
Undo . . . . .	8-21
Uploading . . . . .	5-20
Using existing data . . . . .	App-6
Utilizing panelkit of GT Designer2 . . . . .	7-21

Microsoft, Windows, Windows NT, Windows Vista are registered trademarks of Microsoft Corporation in the United States and other countries.

Adobe and Adobe Reader are registered trademarks of Adobe Systems Incorporated.

Pentium and Celeron are a registered trademarks of Intel Corporation in the United States and other countries.

Ethernet is a trademark of Xerox Co., Ltd. in the United States.

MODBUS is a trademark of Schneider Electric SA.

Other company and product names herein are either trademarks or registered trademarks of their respective owners.

This product uses Arphic Mobile Font.

VS-FlexGrid8

(c)ComponentOne LLC. All rights reserved

LEADTOOLS(r) DLL for Win32

Copyright (c) 1991-2003 LEAD Technologies, Inc.



# *GT Designer2 Version2*

## Operating Manual

(For GOT900 Series)

MODEL	SW2-GT900-O-E
MODEL CODE	1DM216
SH(NA)-080521ENG-O(0903)MEE	

 **MITSUBISHI ELECTRIC CORPORATION**

HEAD OFFICE : TOKYO BUILDING, 2-7-3 MARUNOUCHI, CHIYODA-KU, TOKYO 100-8310, JAPAN  
NAGOYA WORKS : 1-14, YADA-MINAMI 5-CHOME, HIGASHI-KU, NAGOYA, JAPAN

When exported from Japan, this manual does not require application to the Ministry of Economy, Trade and Industry for service transaction permission.

Specifications subject to change without notice.